

# Alfresco™

Open Air Culinary Systems

## AXEDSP-36L PARTS LIST

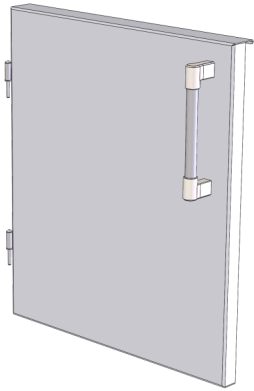

LEFT DOOR  
510-1221



DOOR SEAL LT  
130-2919

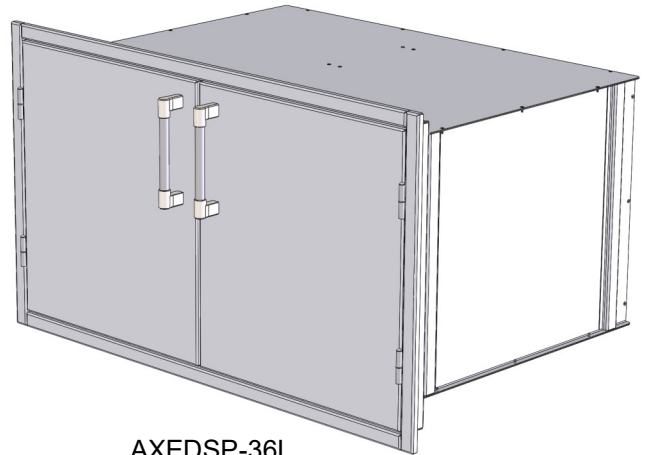

AXEDSP-36L

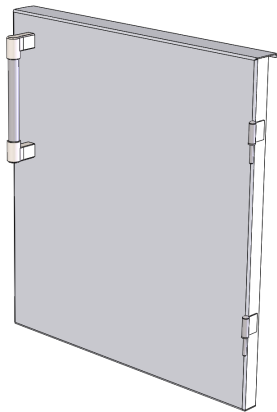

RIGHT DOOR  
510-1125



DOOR SEAL RT  
130-3180

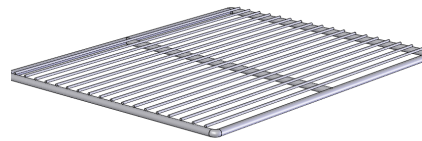

WIRE RACK  
230-0040

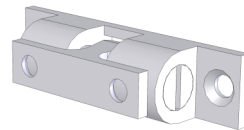

DOOR CATCH  
290-0396

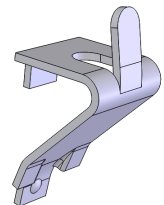

SHELF CLIP  
290-0191

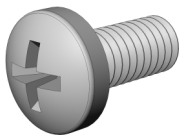

SCREW 200-0100  
SLIDE TO BODY

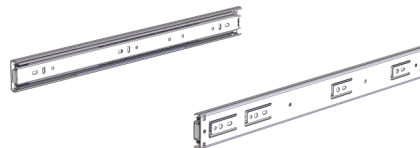

DRAWER SLIDES  
290-0282

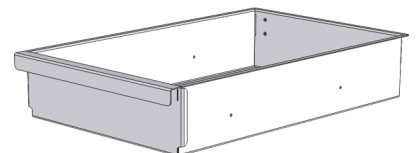

DRAWER 130-2903

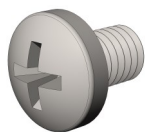

SCREW 200-0083  
SLIDE TO DRAWER

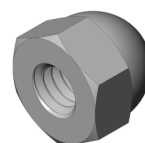

NUT 200-0351  
SLIDE TO DRAWER