

Approval body for construction products
and types of construction

Bautechnisches Prüfamt

An institution established by the Federal and
Laender Governments



European Technical Assessment

ETA-19/0200
of 2 September 2021

English translation prepared by DIBt - Original version in German language

General Part

Technical Assessment Body issuing the
European Technical Assessment:

Deutsches Institut für Bautechnik

Trade name of the construction product

Chemofast Injection System EP 1000
for rebar connection

Product family
to which the construction product belongs

Systems for post-installed
rebar connections with mortar

Manufacturer

CHEMOFAST Anchoring GmbH
Hanns-Martin-Schleyer-Straße 23
47877 Willich
DEUTSCHLAND

Manufacturing plant

CHEMOFAST Anchoring GmbH
Hanns-Martin-Schleyer-Straße 23
47877 Willich
DEUTSCHLAND

This European Technical Assessment
contains

24 pages including 3 annexes which form an integral part
of this assessment

This European Technical Assessment is
issued in accordance with Regulation (EU)
No 305/2011, on the basis of

EAD 330087-01-0601, Edition 06/2021

This version replaces

ETA-19/0200 issued on 29 January 2020

The European Technical Assessment is issued by the Technical Assessment Body in its official language. Translations of this European Technical Assessment in other languages shall fully correspond to the original issued document and shall be identified as such.

Communication of this European Technical Assessment, including transmission by electronic means, shall be in full. However, partial reproduction may only be made with the written consent of the issuing Technical Assessment Body. Any partial reproduction shall be identified as such.

This European Technical Assessment may be withdrawn by the issuing Technical Assessment Body, in particular pursuant to information by the Commission in accordance with Article 25(3) of Regulation (EU) No 305/2011.

Specific Part

1 Technical description of the product

The subject of this European Technical Assessment is the post-installed connection, by anchoring or overlap connection joint, of reinforcing bars (rebars) in existing structures made of normal weight concrete, using the "Chemofast Injection system EP 1000 for rebar connection" in accordance with the regulations for reinforced concrete construction.

Reinforcing bars made of steel with a diameter ϕ from 8 to 40 mm or the tension anchor ZA of sizes M12 to M24 according to Annex A and injection mortar Chemofast EP 1000 are used for rebar connections. The rebar is placed into a drilled hole filled with injection mortar and is anchored via the bond between rebar, injection mortar and concrete.

The product description is given in Annex A.

2 Specification of the intended use in accordance with the applicable European assessment Document

The performances given in Section 3 are only valid if the anchor is used in compliance with the specifications and conditions given in Annex B.

The verifications and assessment methods on which this European Technical Assessment is based lead to the assumption of a working life of the rebar connections of at least 50 and/or 100 years. The indications given on the working life cannot be interpreted as a guarantee given by the producer, but are to be regarded only as a means for choosing the right products in relation to the expected economically reasonable working life of the works.

3 Performance of the product and references to the methods used for its assessment

3.1 Mechanical resistance and stability (BWR 1)

Essential characteristic	Performance
Characteristic resistance under static and quasi-static loading	See Annex C 1
Characteristic resistance under seismic loading	See Annex B4 and C 2

3.2 Safety in case of fire (BWR 2)

Essential characteristic	Performance
Reaction to fire	Class A1
Resistance to fire	See Annex C 3 to C 4

4 Assessment and verification of constancy of performance (AVCP) system applied, with reference to its legal base

In accordance with European Assessment Document EAD No. 330087-01-0601, the applicable European legal act is: [96/582/EC].

The system to be applied is: 1

5 Technical details necessary for the implementation of the AVCP system, as provided for in the applicable European Assessment Document

Technical details necessary for the implementation of the AVCP system are laid down in the control plan deposited with Deutsches Institut für Bautechnik.

Issued in Berlin on 2 September 2021 by Deutsches Institut für Bautechnik

Dipl.-Ing. Beatrix Wittstock
Head of Section

beglaubigt:
Baderschneider

Installation post installed rebar

Figure A1: Overlapping joint for rebar connections of slabs and beams

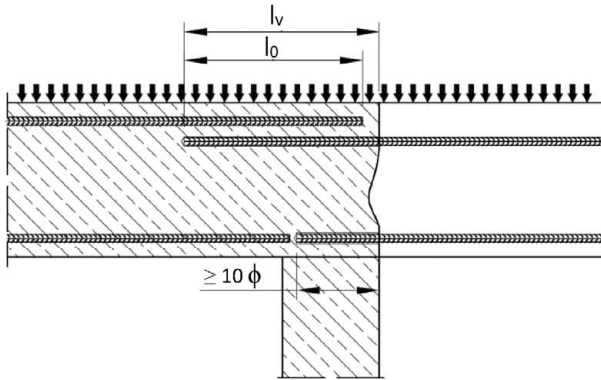

Figure A2: Overlapping joint at a foundation of a wall or column where the rebar are stressed in tension

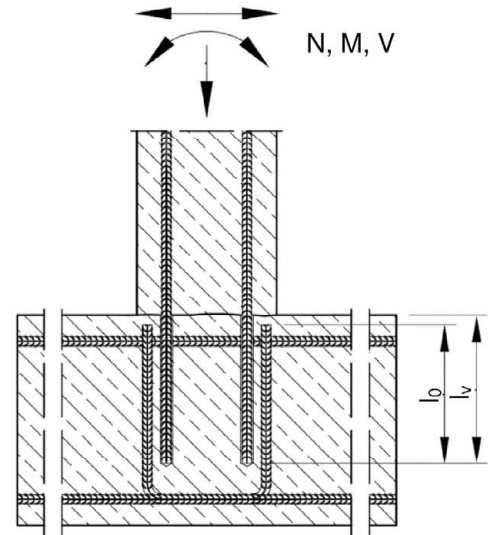

Figure A3: End anchoring of slabs or beams (e.g. designed as simply supported)

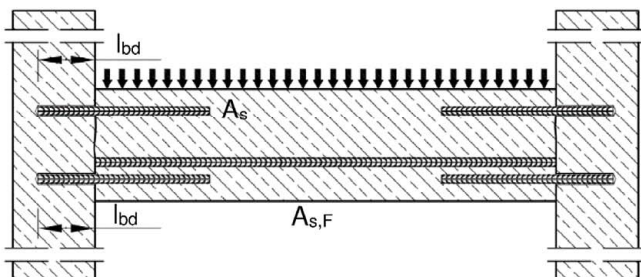

Figure A4: Rebar connection for components stressed primarily in compression. The rebar are stressed in compression

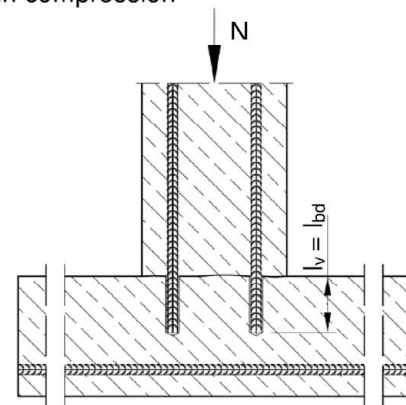
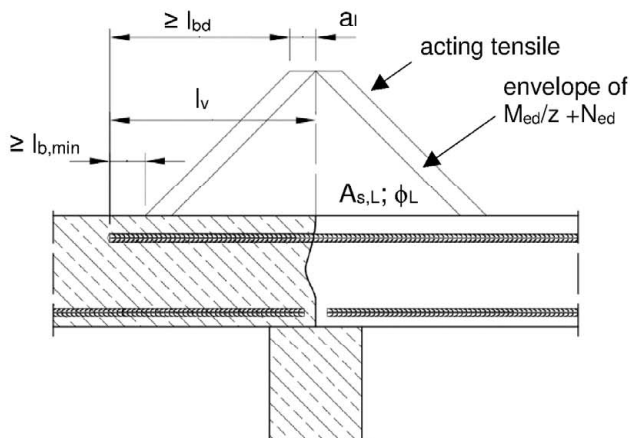

Figure A5: Anchoring of reinforcement to cover the line of acting tensile force



Note to Figure A1 to A5:

In the Figures no transverse reinforcement is plotted, the transverse reinforcement shall comply with EN 1992-1-1:2004+AC:2010.

Preparing of joints according to Annex B 2

Chemofast Injection System EP 1000 for rebar connection

Product description
Installed condition and examples of use for rebars

Annex A 1

Installation tension anchor ZA

Figure A6: Overlapping joint of a column stressed in bending to a foundation

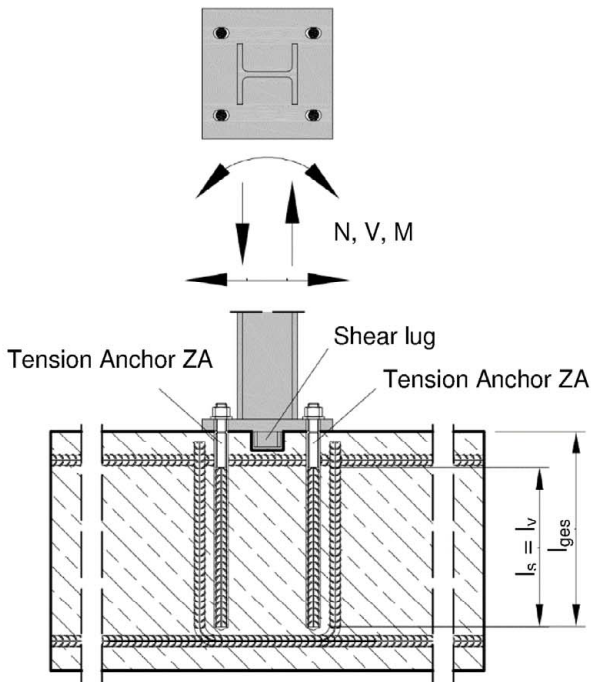

Figure A7: Overlap joint for the anchorage of barrier posts

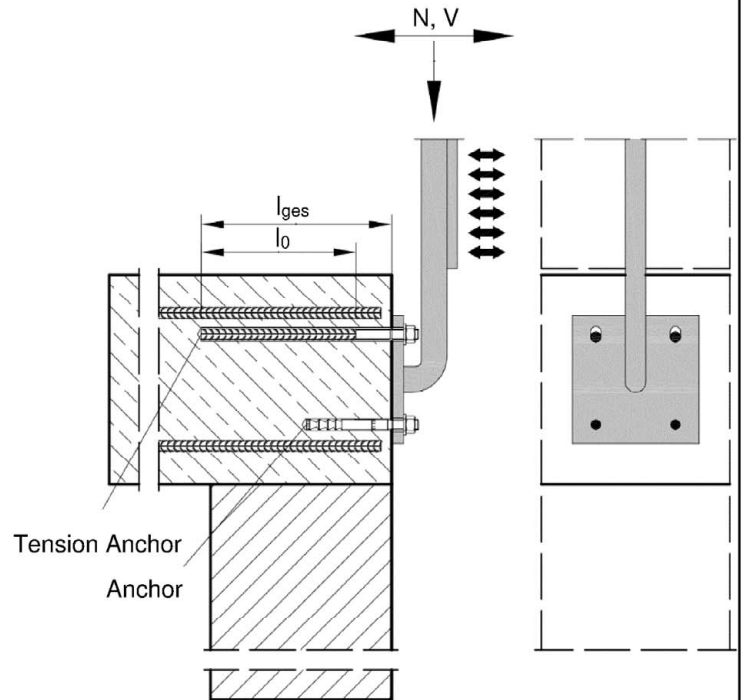
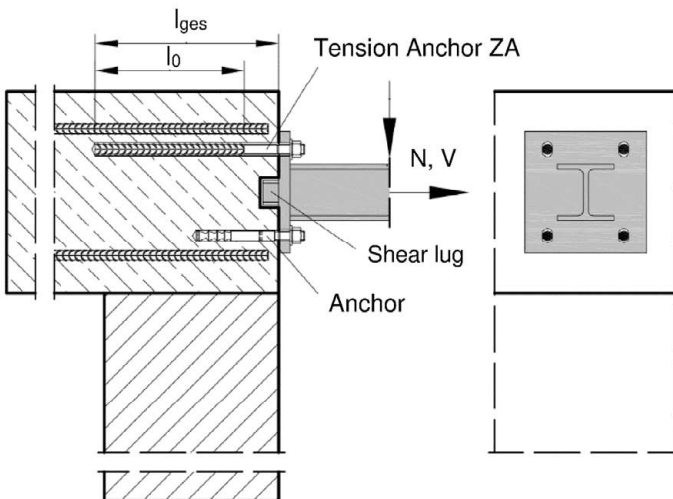

Figure A8: Overlap joint for the anchorage to cantilever members



Note to Figure A6 to A8:

In the Figures no transverse reinforcement is plotted, the transverse reinforcement shall comply with EN 1992-1-1:2002+AC:2010

Chemofast Injection System EP 1000 for rebar connection

Product description

Installed condition and examples of use for tension anchors ZA

Annex A 2

Chemofast Injection System EP 1000:

Injection mortar: Chemofast EP 1000

Type "side-by-side":

440ml, 585 ml and 1400 ml
cartridge

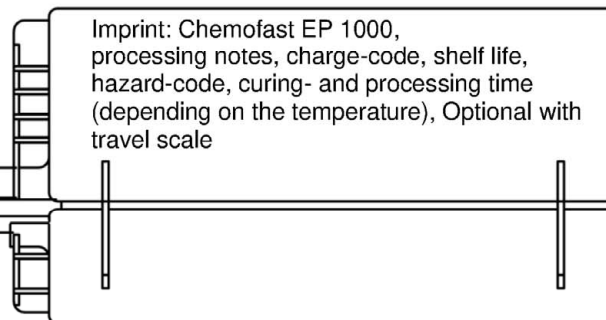
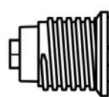

Static Mixer:

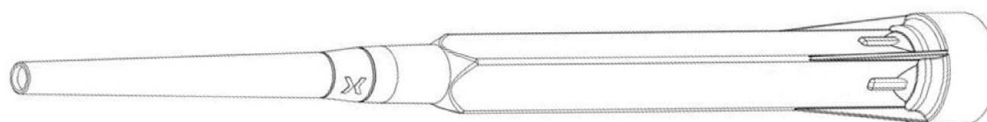

Piston plug and mixer extension

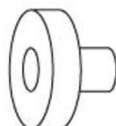

Reinforcing bar (rebar): $\varnothing 8$, $\varnothing 10$, $\varnothing 12$, $\varnothing 14$, $\varnothing 16$, $\varnothing 20$, $\varnothing 22$, $\varnothing 24$, $\varnothing 25$, $\varnothing 28$, $\varnothing 32$, $\varnothing 34$, $\varnothing 36$, $\varnothing 40$



Tension Anchor ZA: M12 to M24

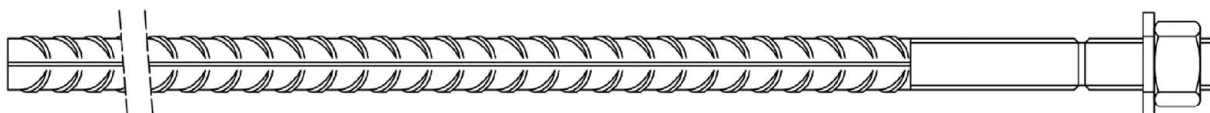

Chemofast Injection System EP 1000 for rebar connection

Product description

Injection mortar / Static mixer / Rebar / Tension Anchor ZA

Annex A 3

Reinforcing bar (rebar): $\phi 8$, $\phi 10$, $\phi 12$, $\phi 14$, $\phi 16$, $\phi 20$, $\phi 22$, $\phi 24$, $\phi 25$, $\phi 28$, $\phi 32$, $\phi 34$, $\phi 36$, $\phi 40$





- Minimum value of related rip area $f_{R,min}$ according to EN 1992-1-1:2004+AC:2010
- Rib height of the bar shall be in the range $0,05\phi \leq h_{rib} \leq 0,07\phi$
(ϕ : Nominal diameter of the bar; h_{rib} : Rib height of the bar)

Table A1: Materials

Designation	Material
Rebar EN 1992-1-1:2004+AC:2010, Annex C	Bars and de-coiled rods class B or C f_{yk} and k according to NDP or NCL of EN 1992-1-1/NA $f_{uk} = f_{tk} = k \cdot f_{yk}$
Chemofast Injection System EP 1000 for rebar connection	Annex A 4
Product description Materials Rebar	

Tension Anchor ZA: M12, M16, M20, M24

Marking: e.g.  ZA 12 A4

	Mark of the producer
ZA	Trade name
12	Rod diameter/thread
A4	for stainless steel A4
HCR	for high corrosion resistance steel

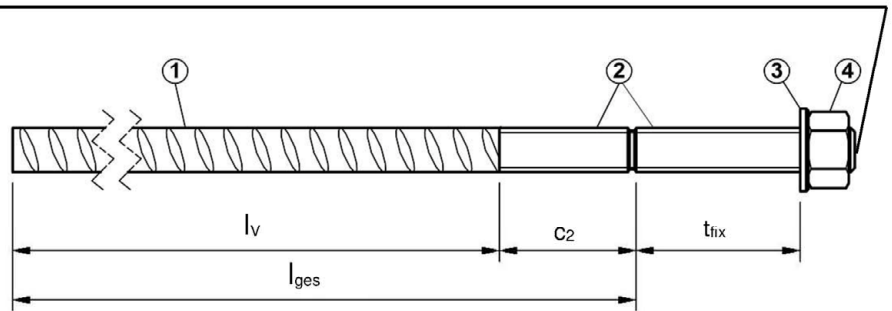

Table A2: Materials

Part	Designation	Material											
		ZA vz				ZA A4				ZA HCR			
		M12	M16	M20	M24	M12	M16	M20	M24	M12	M16	M20	M24
1	Reinforcement bar	Class B according to NDP or NCL of EN 1992-1-1/NA $f_{tk} = f_{tk} = k \cdot f_{yk}$											
	f_{yk} [N/mm ²]	500				500				500			
2	Threaded rod	Steel, zinc plated according to EN ISO 683-4:2018 or EN 10263:2001				Stainless steel, 1.4362, 1.4401, 1.4404, 1.4571, EN 10088-1:2014				High corrosion resistant steel, 1.4529, 1.4565, EN 10088-1:2014			
3	Washer	Steel, zinc plated according to EN ISO 683-4:2018 or EN 10263:2001				Stainless steel, 1.4362, 1.4401, 1.4404, 1.4571, EN 10088-1:2014				High corrosion resistant steel, 1.4529, 1.4565, EN 10088-1:2014			
4	Nut												

Table A3: Dimensions and installation parameter

Size			ZA-M12	ZA-M16	ZA-M20	ZA-M24	
Diameter of threaded rod	d_s	[mm]	12	16	20	24	
Diameter of reinforcement bar	ϕ	[mm]	12	16	20	25	
Drill hole diameter	d_o	[mm]	16	20	25	32	
Diameter of clearance hole in fixture	d_f	[mm]	14	18	22	26	
With across nut flats	SW	[mm]	19	24	30	36	
Stress area	A_s	[mm ²]	84	157	245	353	
Effective embedment depth	l_v	[mm]	according to static calculation				
Length of bonded thread	plated	c_2	[mm]	≥ 20	≥ 20	≥ 20	≥ 20
	A4/HCR			≥ 100	≥ 100	≥ 100	≥ 100
Minimum thickness of fixture	t_{fix}	[mm]	5	5	5	5	
Maximum thickness of fixture	t_{fix}	[mm]	3000	3000	3000	3000	
Maximum installation torque	T_{max}	[Nm]	50	100	150	150	

Chemofast Injection System EP 1000 for rebar connection

Product description
Specifications Tension Anchor ZA

Annex A 5

Specifications of intended use			
Anchorage subject to:		static and quasi-static loads	seismic action
Hammer drilling (HD), Hammer drilling with hollow drill bit (HDB), Compressed air drilling (CD), Or Diamond drilling (DD)	for a working life of 50 years	Ø8 to Ø40 ZA-M12 to ZA-M24	Ø10 to Ø40
	for a working life of 100 years	Ø8 to Ø40 ZA-M12 to ZA-M24	Ø10 to Ø40
	Fire exposure	Ø8 to Ø40 ZA-M12 to ZA-M24	No performance assessed
Temperature Range:	- 40°C to +80°C (max long-term temperature +50 °C and max short-term temperature +80 °C)		
Base materials:			
<ul style="list-style-type: none"> • Reinforced or unreinforced normal weight concrete according to EN 206:2013 + A1:2016. • Strength classes C12/15 to C50/60 according to EN 206:2013 + A1:2016. • Maximum chloride content of 0,40% (CL 0.40) related to the cement content according to EN 206:2013 + A1:2016. • Non-carbonated concrete. <p>Note: In case of a carbonated surface of the existing concrete structure the carbonated layer shall be removed in the area of the post-installed rebar connection with a diameter of $\phi + 60$ mm prior to the installation of the new rebar.</p> <p>The depth of concrete to be removed shall correspond to at least the minimum concrete cover in accordance with EN 1992-1-1:2004+AC:2010. The foregoing may be neglected if building components are new and not carbonated and if building components are in dry conditions.</p>			
Use conditions (Environmental conditions) with tension anchor ZA:			
<ul style="list-style-type: none"> • Structures subject to dry internal conditions (all materials). • For all other conditions according to EN 1993-1-4:2006+A1:2015 corresponding to corrosion resistance class: <ul style="list-style-type: none"> - Stainless steel Stahl A4 according to Annex A 4, Table A1: CRC III - High corrosion resistance steel HCR according to Annex A 4, Table A1: CRC V 			
Design:			
<ul style="list-style-type: none"> • Anchorages are designed under the responsibility of an engineer experienced in anchorages and concrete work. • Verifiable calculation notes and drawings are prepared taking account of the forces to be transmitted. • Design according to EN 1992-1-1:2004+AC:2010, EN 1992-1-2:2004+AC:2008 and Annex B 2 and B 3. • The actual position of the reinforcement in the existing structure shall be determined on the basis of the construction documentation and taken into account when designing. 			
Installation:			
<ul style="list-style-type: none"> • Dry or wet concrete. It must not be installed in flooded holes. • Overhead installation allowed. • Hole drilling by hammer drill (HD), hammer drill with hollow drill bit (HDB), diamond drill (DD) or compressed air drill (CD). • The installation of post-installed rebar resp. tension anchors shall be done only by suitable trained installer and under supervision on site; the conditions under which an installer may be considered as suitable trained and the conditions for supervision on site are up to the Member States in which the installation is done. • Check the position of the existing rebars (if the position of existing rebars is not known, it shall be determined using a rebar detector suitable for this purpose as well as on the basis of the construction documentation and then marked on the building component for the overlap joint). 			
Chemofast Injection System EP 1000 for rebar connection			Annex B 1
Intended use Specifications			

Figure B1: General construction rules for post-installed rebars

- Only tension forces in the axis of the rebar may be transmitted.
- The transfer of shear forces between new concrete and existing structure shall be designed additionally according to EN 1992-1-1:2004+AC:2010.
- The joints for concreting must be roughened to at least such an extent that aggregate protrude.

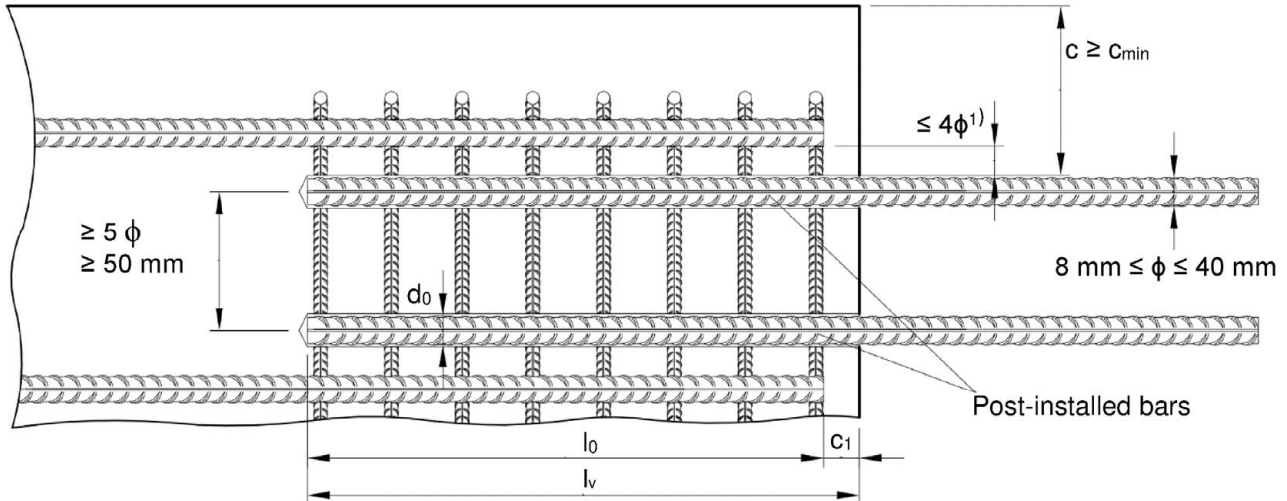

- 1) If the clear distance between lapped bars exceeds 4ϕ , then the lap length shall be increased by the difference between the clear bar distance and 4ϕ .

The following applies to Figure B1:

c	concrete cover of post-installed rebar
c_1	concrete cover at end-face of existing rebar
c_{min}	minimum concrete cover according to Table B1 and to EN 1992-1-1:2004+AC:2010, Section 4.4.1.2
ϕ	diameter of post-installed rebar
l_0	lap length, according to EN 1992-1-1:2004+AC:2010, Section 8.7.3
l_v	effective embedment depth, $\geq l_0 + c_1$
d_0	nominal drill bit diameter, see Annex B 5

Chemofast Injection System EP 1000 for rebar connection

Intended use

General construction rules for post-installed rebars

Annex B 2

Figure B2: General construction rules for tension anchors ZA

- The length of the bonded-in thread may not be accounted as anchorage.
- Only tension forces in the direction of the bar axis may be transmitted by the tension anchor ZA.
- The tension force must be transferred via an overlap joint to the reinforcement in the building part.
- The transfer of shear forces shall be ensured by appropriate additional measures, e.g. shear lugs or by anchors with an European technical assessment.
- In the anchor plate, the holes for the tension anchors shall be executed as elongated holes with axis in the direction of the shear force.

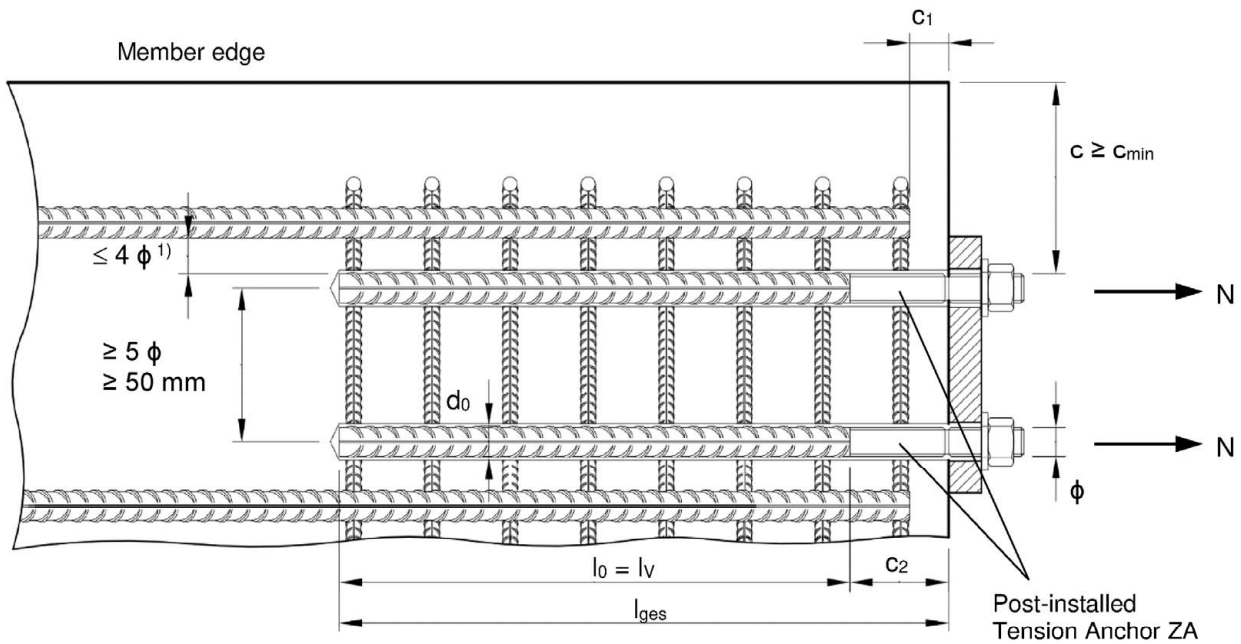

- 1) If the clear distance between lapped bars exceeds 4ϕ , then the lap length shall be increased by the difference between the clear bar distance and 4ϕ .

The following applies to Figure B2:

c	concrete cover of tension anchor ZA
c_1	concrete cover at end-face of existing rebar
c_2	Length of bonded thread
c_{min}	minimum concrete cover according to Table B1 and to EN 1992-1-1:2004+AC:2010, Section 4.4.1.2
ϕ	diameter of tension anchor
l_0	lap length, according to EN 1992-1-1:2004+AC:2010, Section 8.7.3
l_v	effective embedment depth, $\geq l_0 + c_1$
l_{ges}	overall embedment depth, $\geq l_0 + c_2$
d_0	nominal drill bit diameter, see Annex B 4

Chemofast Injection System EP 1000 for rebar connection

Intended use
General construction rules for tension anchors

Annex B 3

Table B1: Minimum concrete cover min $c^{1)}$ of post-installed rebar depending of drilling method

Drilling method	Rebar diameter	Without drilling aid	With drilling aid
Hammer drilling (HD), Hammer drilling with hollow drill (HDB)	< 25 mm	$30 \text{ mm} + 0,06 \cdot l_v \geq 2 \phi$	$30 \text{ mm} + 0,02 \cdot l_v \geq 2 \phi$
	$\geq 25 \text{ mm}$	$40 \text{ mm} + 0,06 \cdot l_v \geq 2 \phi$	$40 \text{ mm} + 0,02 \cdot l_v \geq 2 \phi$
Diamond drilling (DD)	< 25 mm	Drill rig used as drilling aid	$30 \text{ mm} + 0,02 \cdot l_v \geq 2 \phi$
	$\geq 25 \text{ mm}$		$40 \text{ mm} + 0,02 \cdot l_v \geq 2 \phi$
Compressed air drilling (CD)	< 25 mm	$50 \text{ mm} + 0,08 \cdot l_v$	$50 \text{ mm} + 0,02 \cdot l_v$
	$\geq 25 \text{ mm}$	$60 \text{ mm} + 0,08 \cdot l_v \geq 2 \phi$	$60 \text{ mm} + 0,02 \cdot l_v \geq 2 \phi$

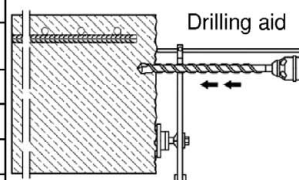

¹⁾ see Annex B 2, Figure B1 and Annex B 3, Figure B2

Comments: The minimum concrete cover acc. EN 1992-1-1:2004+AC:2010 must be observed
For minimum concrete cover in case of seismic action $c_{min,seis}$ see Table B2.

Table B2: Minimum concrete cover min $c_{min,seis}$

Drilling method	Design condition	Distance of 1 st edge	Distance of 2 nd edge
Hammer drilling (HD), Hammer drilling with hollow drill (HDB), Compressed air drilling (CD)	Edge	$\geq 2 \phi$	$\geq 2 \phi$
	Corner	$\geq 2 \phi$	$\geq 2 \phi$
Diamond drilling (DD)	Edge	$\geq 4 \phi$	$\geq 8 \phi$
	Corner	$\geq 6 \phi$	$\geq 6 \phi$

Table B3: Base material temperature, gelling time and curing time

Temperature in base material	Maximum Gelling- / working time ¹⁾	Initial curing time in dry concrete ²⁾	Minimum curing time in dry concrete ³⁾
	t_{gel}	$t_{cure,ini}$	t_{cure}
0 °C to + 4°C	80 min	30 h	144 h
+ 5 °C to + 9°C	80 min	20 h	48 h
+ 10 °C to + 14°C	60 min	15 h	28 h
+ 15 °C to + 19°C	40 min	9 h	18 h
+ 20 °C to + 24°C	30 min	6 h	12 h
+ 25 °C to + 34°C	12 min	4 h	9 h
+ 35 °C to + 39°C	8 min	3 h	6 h
+40 °C	8 min	1,5 h	4 h

Cartridge temperature +5°C to +40°C

¹⁾ t_{gel} : maximum time from starting of mortar injection to completing of rebar setting.

²⁾ After $t_{cure,ini}$ has elapsed, the installation of the connecting reinforcement and the construction of the formwork can be continued

³⁾ In wet concrete the curing times must be doubled.





Chemofast Injection System EP 1000 for rebar connection

Intended use

Minimum concrete cover
Gelling and curing time

Annex B 4

Table B4: Dispensing tools

Cartridge type/size	Hand tool		Pneumatic tool
Side-by-side cartridges 440, 585 ml	 e.g. SA 296C585	 e.g. Typ H 244 C	 e.g. Typ TS 444 KX
Side-by-side cartridges 1400 ml	-	-	 e.g. Typ TS 471

Ale cartridges can be used with battery tool as well.

Cleaning and installation tools

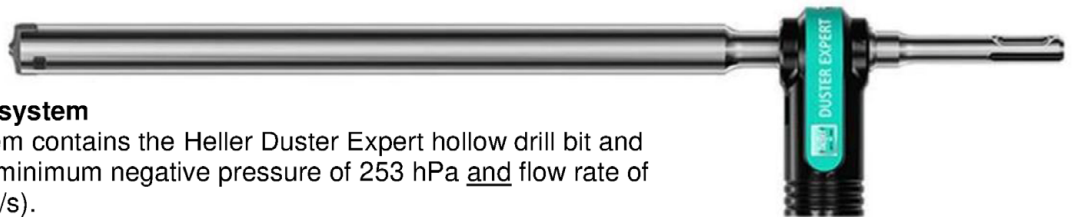

HDB – Hollow drill bit system

The hollow drill bit system contains the Heller Duster Expert hollow drill bit and a class M vacuum with minimum negative pressure of 253 hPa and flow rate of minimum 150 m³/h (42 l/s).

Brush RB:



SDS Plus Adapter:



Brush extension:

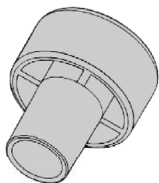

Piston Plug



Hand pump (volume 750 ml)

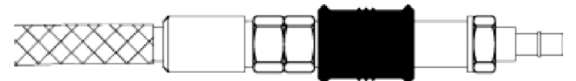

**Rec. compressed air tool
hand slide valve (min 6 bar)**

Chemofast Injection System EP 1000 for rebar connection

Intended Use

Dispensing, cleaning and installation tools

Annex B 5

Bar size ϕ [mm]	Tension anchor ϕ [mm]	Drill bit - \emptyset			d_b Brush - \emptyset [mm]	$d_{b,min}$ min. Brush - \emptyset [mm]	Piston plug	Cartridge: 440 ml or 585 ml				Cartridge: 1400 ml	
		HD	DD	CD				Hand or battery tool		Pneumatic tool		Pneumatic tool	
								$l_{v,max}$ [mm]	Mixer extension	$l_{v,max}$ [mm]	Mixer extension	$l_{v,max}$ [mm]	Mixer extension
8	-	10	-	RB10	11,5	10,5	-	250	VL10/0,75 or VL16/1,8	250	VL10/0,75 or VL16/1,8	250	
	-	12	-	RB12	13,5	12,5	-	700		800		800	
10	-	14	-	RB14	15,5	14,5	VS14	250		250		250	
	-		700					1000		1000			
12	ZA-M12	16	-	RB16	17,5	16,5	VS16	250		250		250	
	-		1300					1300		1200			
14	-	18	-	RB18	20,0	18,5	VS18	700		1400		1400	
16	ZA-M16	20	-	RB20	22,0	20,5	VS20	500		1000		2000	
20	ZA-M20	25	-	RB25	27,0	25,5	VS25						
	-	-	26	RB26	28,0	26,5	VS25	500		1000		2000	
22	-	28	-	RB28	30,0	28,5	VS28						
24/25	ZA-M24	30	-	RB30	32,0	30,5	VS30						
	-	32	-	RB32	34,0	32,5	VS32	-	-	-			
28	-	35	-	RB35	37,0	35,5	VS35						
32/34	-	40	-	RB40	43,5	40,5	VS40	-	-	-			
36	-	45	-	RB45	47,0	45,5	VS45						
40	-	-	52	-	RB52	54,0	52,5	VS52	-	-	-		
	-	55	-	55	RB55	58,0	55,5	VS55					

Bar size ϕ [mm]	Tension anchor ϕ [mm]	Drill bit - \emptyset	d_b Brush - \emptyset	$d_{b,min}$ min. Brush - \emptyset	Piston plug	Cartridge: 440 ml or 585 ml				Cartridge: 1400 ml	
		HDB				Hand or battery tool		Pneumatic tool		Pneumatic tool	
						$l_{v,max}$ [mm]	Mixer extension	$l_{v,max}$ [mm]	Mixer extension	$l_{v,max}$ [mm]	Mixer extension
8	-	10	No cleaning Required	-	-	250	VL10/0,75 or VL16/1,8	250	VL10/0,75 or VL16/1,8	250	
	-	12		-	700	800		800			
10	-	14		VS14	250	250		250			
	-				700	1000		1000			
12	ZA-M12	16		VS16	250	250		250			
	-				700	700		700		700	
14	-	18		VS18	500	1000		1000			
16	ZA-M16	20		VS20							
20	ZA-M20	25		VS25	500	1000		1000			
22	-	28		VS28							
24/25	ZA-M24	30		VS30							
	-	32		VS32	-	-	-				
28	-	35		VS35							
32/34	-	40		VS40	-	-	-				

Chemofast Injection System EP 1000 for rebar connection	Annex B 6
Intended use Installation tools	

A) Bore hole drilling

Note: Before drilling, remove carbonated concrete and clean contact areas (see Annex B1)

In case of aborted drill hole: the drill hole shall be filled with mortar.

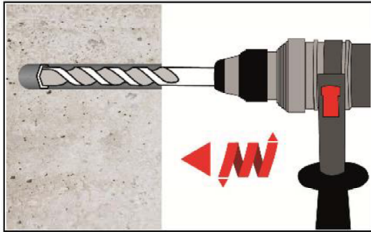

- 1a. Hammer (HD) or compressed air drilling (CD)**
Drill a hole into the base material to the size and embedment depth required by the selected reinforcing bar. Proceed with Step B1 (MAC or CAC).

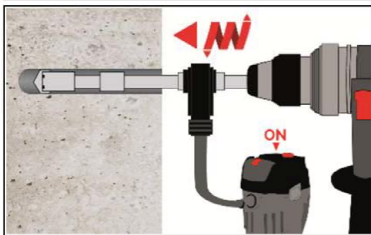

- 1b. Hollow drill bit system (HDB)** (see Annex B 5)
Drill a hole into the base material to the size and embedment depth required by the selected reinforcing bar. This drilling system removes the dust and cleans the bore hole during drilling.
Proceed with Step C.

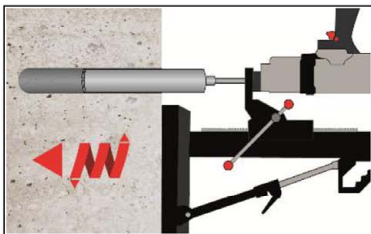

- 1c. Diamond drilling (DD)**
Drill with diamond drill a hole into the base material to the size and embedment depth required by the selected anchor
Proceed with Step B2.

Chemofast Injection System EP 1000 for rebar connection

Intended use

Installation instruction: Bore hole drilling (HD, CD, HDB and DD)

Annex B 7

B1) Bore hole cleaning (HD and CD)

MAC: Cleaning for bore hole diameter $d_0 \leq 20\text{mm}$ and bore hole depth $h_0 \leq 10d_s$

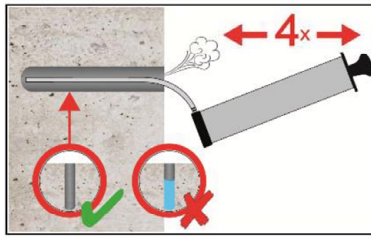

Attention! Standing water in the bore hole must be removed before cleaning.

2a. Starting from the bottom or back of the bore hole, blow the hole clean with a hand pump (Annex B 5) a minimum of four times. If the bore hole ground is not reached an extension shall be used.

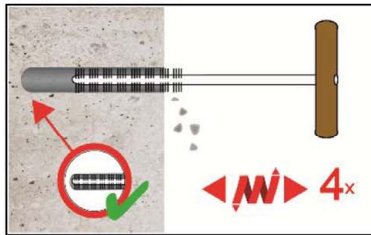

2b. Check brush diameter (Table B5). Brush the hole with an appropriate sized wire brush $> d_{b,\text{min}}$ (Table B5) a minimum of four times in a twisting motion. If the bore hole ground is not reached with the brush, a brush extension shall be used.

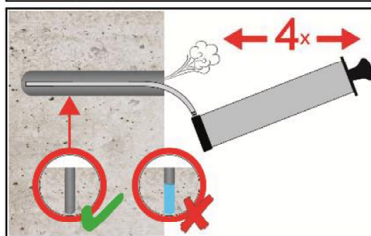

2c. Finally blow the hole clean again with a hand pump (Annex B 5) a minimum of four times. If the bore hole ground is not reached an extension shall be used

CAC: Cleaning for all bore hole diameter and bore hole depth with drilling method HD and CD

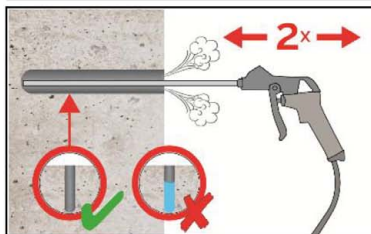

Attention! Standing water in the bore hole must be removed before cleaning.

2a. Starting from the bottom or back of the bore hole, blow the hole clean with compressed air (min. 6 bar) (Annex B 5) a minimum of two times until return air stream is free of noticeable dust. If the bore hole ground is not reached an extension shall be used

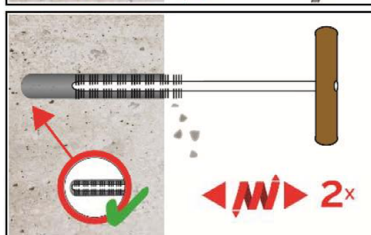

2b. Check brush diameter (Table B5). Brush the hole with an appropriate sized wire brush $> d_{b,\text{min}}$ (Table B5) a minimum of two times in a twisting motion. If the bore hole ground is not reached with the brush, a brush extension shall be used.

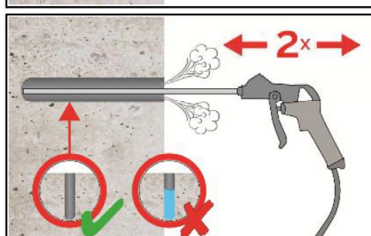

2c. Finally blow the hole clean again with compressed air (min. 6 bar) (Annex B 5) a minimum of two times until return air stream is free of noticeable dust. If the bore hole ground is not reached an extension shall be used.

After cleaning, the bore hole has to be protected against re-contamination in an appropriate way, until dispensing the mortar in the bore hole. If necessary, the cleaning has to be repeated directly before dispensing the mortar.

Chemofast Injection System EP 1000 for rebar connection

Intended use

Installation instruction: Bore hole cleaning (HD and CD)

Annex B 8

B2) Bore hole cleaning (DD)

SPCAC: Cleaning for all bore hole diameter and bore hole depth with drilling method DD

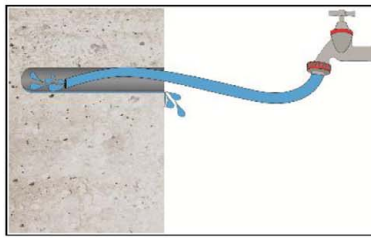

2a. Rinsing with water until clear water comes out.

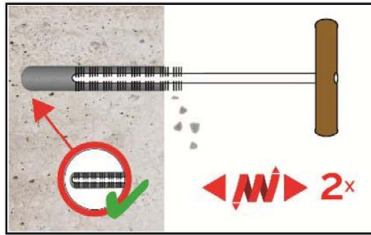

2b. Check brush diameter (Table B5). Brush the hole with an appropriate sized wire brush $> d_{b,min}$ (Table B5) a minimum of two times in a twisting motion. If the bore hole ground is not reached with the brush, a brush extension must be used.

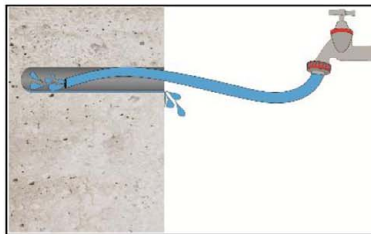

2c. Rinsing again with water until clear water comes out.

Attention! Standing water in the bore hole must be removed before cleaning.

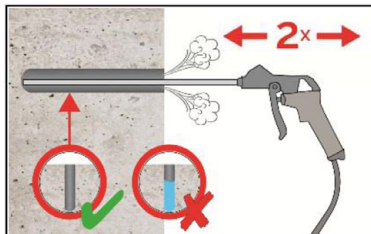

2d. Starting from the bottom or back of the bore hole, blow the hole clean with compressed air (min. 6 bar) (Annex B 5) a minimum of two times until return air stream is free of noticeable dust. If the bore hole ground is not reached an extension shall be used

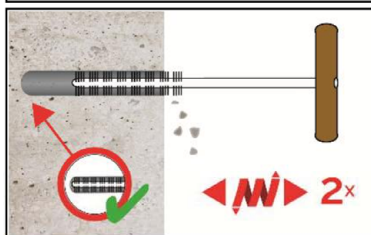

2e. Check brush diameter (Table B5). Brush the hole with an appropriate sized wire brush $> d_{b,min}$ (Table B5) a minimum of two times in a twisting motion. If the bore hole ground is not reached with the brush, a brush extension shall be used.

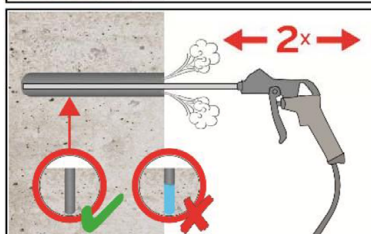

2f. Finally blow the hole clean again with compressed air (min. 6 bar) (Annex B 5) a minimum of two times until return air stream is free of noticeable dust. If the bore hole ground is not reached an extension shall be used.

After cleaning, the bore hole has to be protected against re-contamination in an appropriate way, until dispensing the mortar in the bore hole. If necessary, the cleaning has to be repeated directly before dispensing the mortar.

Chemofast Injection System EP 1000 for rebar connection

Intended use

Installation instruction: Bore hole cleaning (DD)

Annex B 9

C) Preparation of bar and cartridge

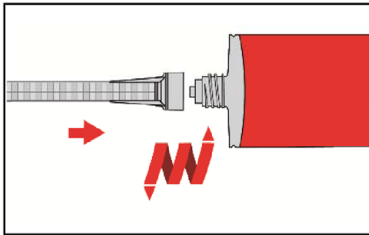

3. Attach the supplied static-mixing nozzle to the cartridge and load the cartridge into the correct dispensing tool.
For every working interruption longer than the recommended working time (Table B3) as well as for every new cartridges, a new static-mixer shall be used.

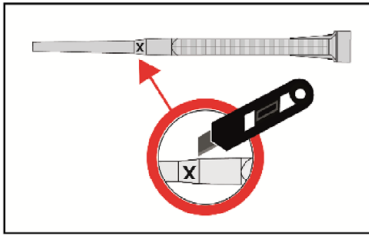

- 3a. In case of using the mixer extension VL16/1,8, the tip of the mixer nozzle has to be cut off at position „X“.

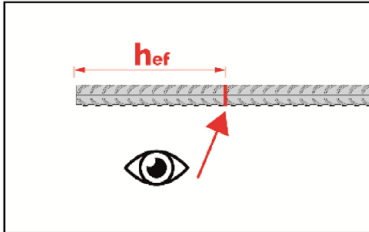

4. Prior to inserting the reinforcing bar into the filled bore hole, the position of the embedment depth shall be marked (e.g. with tape) on the reinforcing bar and insert bar in empty hole to verify hole and depth l_v .
The reinforcing bar should be free of dirt, grease, oil or other foreign material.

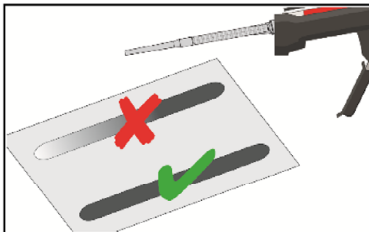

5. Prior to dispensing into the bore hole, squeeze out separately the mortar until it shows a consistent grey or red colour, but a minimum of three full strokes, and discard non-uniformly mixed adhesive components.

D) Filling the bore hole

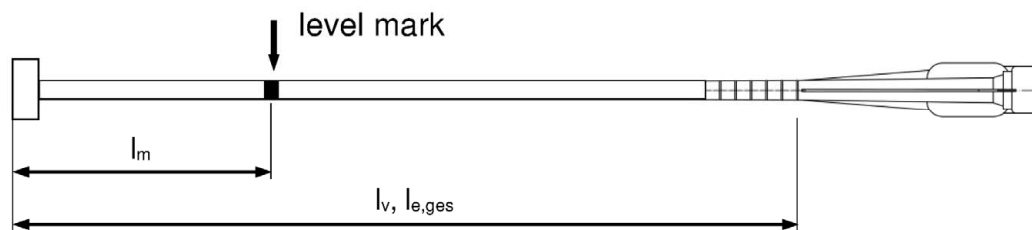

Injection tool must be marked by mortar level mark l_m and anchorage depth l_v resp. $l_{e,ges}$ with tape or marker.

Quick estimation: $l_m = 1/3 \cdot l_v$

Continue injection until the mortar level mark l_m becomes visible.

Optimum mortar volume:

$$l_m = l_v \text{ resp. } l_{e,ges} \cdot \left(1,2 \cdot \frac{\phi^2}{d_0^2} - 0,2 \right)$$

Chemofast Injection System EP 1000 for rebar connection

Intended Use

Installation instruction: Preparation of bar and cartridge
Filling the bore hole

Annex B 10

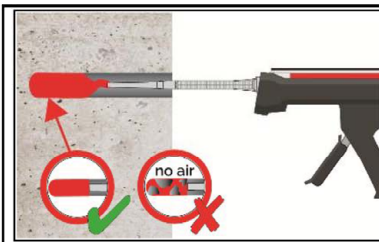

6a. Starting from the bottom or back of the cleaned bore hole fill the hole with adhesive, until the level mark at the mixer extension is visible at the top of the hole. If the bottom or back of the anchor hole is not reached, an appropriate extension nozzle must be used. Slowly withdraw the static mixing nozzle and using a piston plugs during injection of the mortar, helps to avoid creating air pockets. Observe the gel-/ working times given in Table B3.

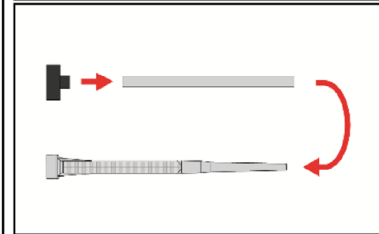

6b. Piston plugs shall be used according to Table B5 or B6 for the following applications:

- For overhead and horizontal installation
- In vertical downwards direction with bore holes deeper than 250 mm

Assemble mixing nozzle, mixer extension and piston plug before injecting mortar.

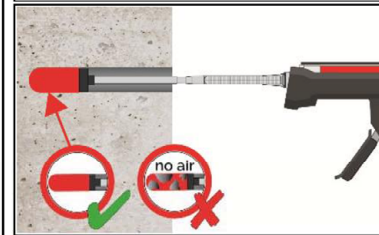

6c. Insert piston plug to back of the hole and inject adhesive. If the bottom or back of the anchor hole is not reached, an appropriate extension nozzle must be used. During injection the piston plug will be naturally extruded out of the drill hole by the adhesive pressure. Observe the gel-/ working times given in Table B3.

E) Setting the rebar

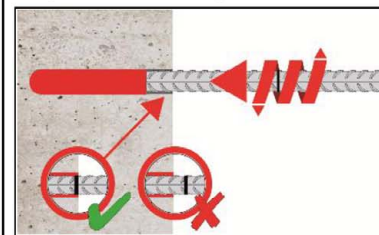

7. Push the reinforcing bar into the bore hole while turning slightly to ensure positive distribution of the adhesive until the embedment depth is reached.

The reinforcing bar should be free of dirt, grease, oil or other foreign material.

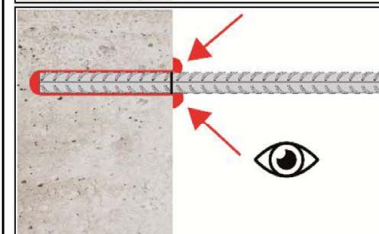

8. Be sure that the bar is inserted in the bore hole until the embedment mark is at the concrete surface and that excess mortar is visible at the top of the hole. If these requirements are not maintained, the application has to be renewed.



8a. For horizontal and overhead installation fix embedded part (e.g. with wedges) until the mortar has started to harden.

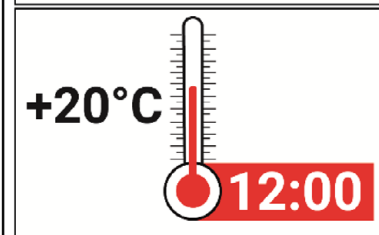

9. Observe gelling and curing time in Table B3. Slightly adjustment of the reinforcing bar within the gelling time t_{gel} is possible. After the time $t_{cure,ini}$ has elapsed, the installation of the connecting reinforcement and the formwork can be continued. The full load to the reinforcing bar may be applied after the full curing time t_{cure} has elapsed. Attend that the gelling and curing time can vary according to the base material temperature.

Chemofast Injection System EP 1000 for rebar connection

Intended Use
Installation instruction: Inserting rebar

Annex B 11

Table C1: Characteristic tension resistance for tension anchor ZA										
Tension Anchor			M12	M16	M20	M24				
Steel, zinc plated (ZA vz)										
Characteristic tension resistance	NR _{k,s}	[kN]	67	125	196	282				
Partial factor	γ _{Ms,N}	[-]	1,4							
Stainless Steel (ZA A4 or ZA HCR)										
Characteristic tension resistance	NR _{k,s}	[kN]	67	125	171	247				
Partial factor	γ _{Ms,N}	[-]	1,4		1,3	1,4				
Minimum anchorage length and minimum lap length under static or quasi-static loading										
The minimum anchorage length $l_{b,min}$ and the minimum lap length $l_{o,min}$ according to EN 1992-1-1:2004+AC:2010 ($l_{b,min}$ acc. to Eq. 8.6 and Eq. 8.7 and $l_{o,min}$ acc. to Eq. 8.11) shall be multiply by the amplification factor $\alpha_{lb} = \alpha_{lb,100y}$ according to Table C2.										
Table C2: Amplification factor $\alpha_{lb} = \alpha_{lb,100y}$ related to concrete class and drilling method; working life 50 and 100 years										
Concrete class		Drilling method		Bar size		Amplification factor $\alpha_{lb} = \alpha_{lb,100y}$				
C12/15 to C50/60		all drilling methods		8 mm to 40 mm ZA-M12 to ZA-M24		1,0				
Table C3: Reduction factor $k_b = k_{b,100y}$ for all drilling methods; working life 50 and 100 years										
Rebar		Concrete class								
φ		C12/15	C16/20	C20/25	C25/30	C30/37	C35/45	C40/50	C45/55	C50/60
8 to 40 mm ZA-M12 to ZA-M24		1,0								
Table C4: Design values of the ultimate bond stress $f_{bd,PIR}$ and $f_{bd,PIR,100y}$ in N/mm² for all drilling methods and for good conditions; working life 50 and 100 years										
$f_{bd,PIR} = k_b \cdot f_{bd}$										
$f_{bd,PIR,100y} = k_{b,100y} \cdot f_{bd}$										
with										
f_{bd} : Design value of the ultimate bond stress in N/mm ² considering the concrete classes, the rebar diameter, the drilling method for good bond condition (for all other bond conditions multiply the values by $\eta_1 = 0.7$) and recommended partial factor $\gamma_c = 1,5$ according to EN 1992-1-1:2004+AC:2010.										
$k_b, k_{b,100y}$: Reduction factor according to Table C3										
Rebar		Concrete class								
φ		C12/15	C16/20	C20/25	C25/30	C30/37	C35/45	C40/50	C45/55	C50/60
8 to 32 mm ZA-M12 to ZA-M24		1,6	2,0	2,3	2,7	3,0	3,4	3,7	4,0	4,3
34 mm		1,6	2,0	2,3	2,6	2,9	3,3	3,6	3,9	4,2
36 mm		1,5	1,9	2,2	2,6	2,9	3,3	3,6	3,8	4,1
40 mm		1,5	1,8	2,1	2,5	2,8	3,1	3,4	3,7	4,0
Chemofast Injection System EP 1000 for rebar connection							Annex C 1			
Performances Amplification factor $\alpha_{lb} = \alpha_{lb,100y}$, Reduction factor $k_b = k_{b,100y}$, Design values of ultimate bond resistance $f_{bd,PIR} = f_{bd,PIR,100y}$										

Minimum anchorage length and minimum lap length under seismic action

The minimum anchorage length $l_{b,min}$ and the minimum lap length $l_{o,min}$ according to EN 1992-1-1:2004+AC:2010 ($l_{b,min}$ acc. to Eq. 8.6 and Eq. 8.7 and $l_{o,min}$ acc. to Eq. 8.11) shall be multiply by the amplification factor $\alpha_{l_{b,seis}} = \alpha_{l_{b,seis},100y}$ according to Table C5.

Table C5: Amplification factor $\alpha_{l_{b,seis}} = \alpha_{l_{b,seis},100y}$ related to concrete class and drilling method; working life 50 and 100 years

Concrete class	Drilling method	Bar size	Amplification factor $\alpha_{l_{b,seis}} = \alpha_{l_{b,seis},100y}$
C16/20 to C50/60	all drilling methods	10 mm to 40 mm	1,0

Table C6: Reduction factor $k_{b,seis} = k_{b,seis},100y$ for all drilling methods; working life 50 and 100 years

Rebar ϕ	Concrete class								
	C12/15	C16/20	C20/25	C25/30	C30/37	C35/45	C40/50	C45/55	C50/60
10 to 40 mm	No parameter assessed	1,0							

Table C7: Design values of the ultimate bond stress $f_{bd,PIR,seis}$ and $f_{bd,PIR,seis},100y$ in N/mm² for all drilling methods and for good conditions; working life 50 and 100 years

$$f_{bd,PIR,seis} = k_{b,seis} \cdot f_{bd}$$

$$f_{bd,PIR,seis},100y = k_{b,seis},100y \cdot f_{bd}$$

with

f_{bd} : Design value of the ultimate bond stress in N/mm² considering the concrete classes, the rebar diameter, the drilling method for good bond condition (for all other bond conditions multiply the values by $\eta_1 = 0.7$) and recommended partial factor $\gamma_c = 1,5$ according to EN 1992-1-1:2004+AC:2010.

$k_{b,seis}, k_{b,seis},100y$: Reduction factor according to Table C6

Rebar ϕ	Concrete class								
	C12/15	C16/20	C20/25	C25/30	C30/37	C35/45	C40/50	C45/55	C50/60
10 to 32 mm	No parameter assessed	2,0	2,3	2,7	3,0	3,4	3,7	4,0	4,3
34 mm		2,0	2,3	2,6	2,9	3,3	3,6	3,9	4,2
36 mm		1,9	2,2	2,6	2,9	3,3	3,6	3,8	4,1
40 mm		1,8	2,1	2,5	2,8	3,1	3,4	3,7	4,0

Chemofast Injection System EP 1000 for rebar connection

Performances

Amplification factor $\alpha_{l_{b,seis}} = \alpha_{l_{b,seis},100y}$, Reduction factor $k_{b,seis} = k_{b,seis},100y$,
Design values of ultimate bond resistance $f_{bd,PIR,seis} = f_{bd,PIR,seis},100y$

Annex C 2

Design value of the ultimate bond stress $f_{bd,fi}$, $f_{bd,fi,100y}$ at increased temperature for concrete classes C12/15 to C50/60, (all drilling methods); working life 50 and 100 years:

The design value of the bond stress $f_{bd,fi}$ at increased temperature has to be calculated by the following equation:

For working life 50 years: $f_{bd,fi} = k_{fi}(\theta) \cdot f_{bd,PIR} \cdot \gamma_c / \gamma_{M,fi}$
 with: $\theta \leq 278^\circ\text{C}$: $k_{fi}(\theta) = 4673,8 \cdot \theta^{-1,598} / (f_{bd,PIR} \cdot 4,3) \leq 1,0$
 $\theta > 278^\circ\text{C}$: $k_{fi}(\theta) = 0$

For working life 100 years: $f_{bd,fi,100y} = k_{fi,100y}(\theta) \cdot f_{bd,PIR,100y} \cdot \gamma_c / \gamma_{M,fi}$
 with: $\theta \leq 278^\circ\text{C}$: $k_{fi,100y}(\theta) = 4673,8 \cdot \theta^{-1,598} / (f_{bd,PIR,100y} \cdot 4,3) \leq 1,0$
 $\theta > 278^\circ\text{C}$: $k_{fi,100y}(\theta) = 0$

- $f_{bd,fi}$, $f_{bd,fi,100y}$ Design value of the ultimate bond stress at increased temperature in N/mm²
- θ Temperature in °C in the mortar layer.
- $k_{fi}(\theta)$, $k_{fi,100y}(\theta)$ Reduction factor at increased temperature.
- $f_{bd,PIR}$, $f_{bd,PIR,100y}$ Design value of the bond stress $f_{bd,PIR} = f_{bd,PIR,100y}$ in N/mm² in cold condition according to Table C4 considering the concrete classes, the rebar diameter, the drilling method and the bond conditions according to EN 1992-1-1:2004+AC:2010.
- γ_c = 1,5, recommended partially safety factor according to EN 1992-1-1:2004+AC:2010
- $\gamma_{M,fi}$ = 1,0, recommended partially safety factor according to EN 1992-1-2:2004+AC:2008

For evidence at increased temperature the anchorage length shall be calculated according to EN 1992-1-1:2004+AC:2010 Equation 8.3 using the temperature-dependent design value of ultimate bond stress $f_{bd,fi}$.

Example graph of Reduction factor $k_{fi}(\theta)$, $k_{fi,100y}(\theta)$ for concrete classes C20/25 for good bond conditions:

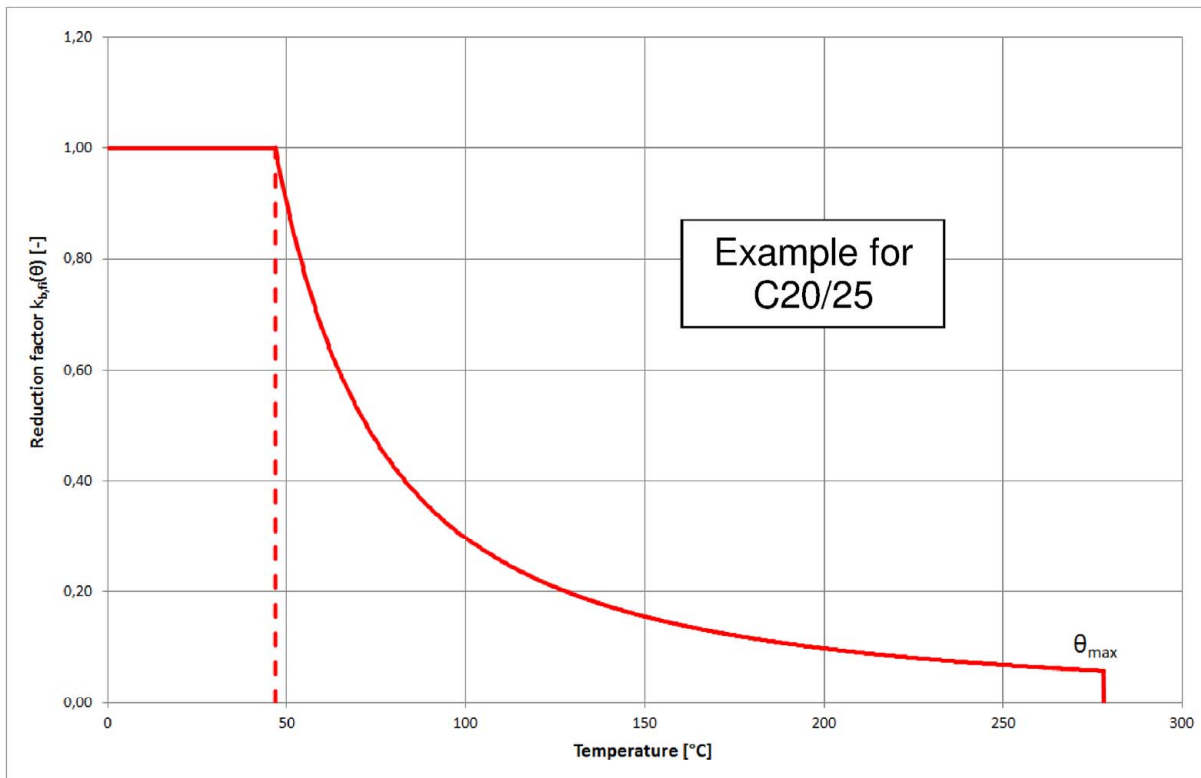

Chemofast Injection System EP 1000 for rebar connection

Performances
Design value of ultimate bond stress $f_{bd,fi}$, $f_{bd,fi,100y}$ at increased temperature

Annex C 3

Table C8: Characteristic tension resistance for tension anchor ZA under fire exposure,
concrete classes C12/15 to C50/60, according to EN 1992-4:2018

Tension Anchor				M12	M16	M20	M24
Steel, zinc plated (ZA vz)							
Characteristic tension resistance	R30	$N_{Rk,s,fi}$	[kN]	2,3	4,0	6,3	9,0
	R60			1,7	3,0	4,7	6,8
	R90			1,5	2,6	4,1	5,9
	R120			1,1	2,0	3,1	4,5
Stainless Steel (ZA A4 or ZA HCR)							
Characteristic tension resistance	R30	$N_{Rk,s,fi}$	[kN]	3,4	6,0	9,4	13,6
	R60			2,8	5,0	7,9	11,3
	R90			2,3	4,0	6,3	9,0
	R120			1,8	3,2	5,0	7,2
Chemofast Injection System EP 1000 for rebar connection				Annex C 4			
Performances Characteristic tension resistance for tension anchor under fire exposure							