



vETA-Danmark A/S
Göteborg Plads 1 DK-
2150 Nordhavn Tel.
+45 72 24 59 00
Fax +45 72 24 59 04
Internet ww.etadanmark.dk

Authorised and notified according
to Article 29 of the Regulation
(EU) No 305/2011 of the
European Parliament and of the
Council of 9 March 2011

MEMBER OF EOTA



European Technical Assessment ETA-22/0884 of 2022/12/09

I General Part

Technical Assessment Body issuing the ETA and designated according to Article 29 of the Regulation (EU) No 305/2011: ETA-Danmark A/S

Trade name of the construction product:

Chemofast ResiTHERM® 12
Chemofast ResiTHERM® 16

Product family to which the above construction product belongs:

Distance fixing system

Manufacturer:

Chemofast Anchoring GmbH
Hanns-Martin-Schleyer-Str. 23
47877 Willich
Germany
www.chemofast.com

Manufacturing plant:

CELO Befestigungssysteme GmbH
Industriestraße 6
DE-86551 Aichach

This European Technical Assessment contains:

30 pages including 25 annexes which form an integral part of the document

This European Technical Assessment is issued in accordance with Regulation (EU) No 305/2011, on the basis of:

EAD 331985-01-0604 – Distance fixing system

This version replaces:

Translations of this European Technical Assessment in other languages shall fully correspond to the original issued document and should be identified as such.

Communication of this European Technical Assessment, including transmission by electronic means, shall be in full (except the confidential Annexes referred to above). However, partial reproduction may be made with the written consent of the issuing Technical Assessment Body. Any partial reproduction has to be identified as such.

II SPECIFIC PART OF THE EUROPEAN TECHNICAL ASSESSMENT

1 Technical description of product

Technical description of the product

Chemofast ResiTHERM[®] 12 and Chemofast ResiTHERM[®] 16 are post-installed anchor systems placed into predrilled holes in concrete, in masonry and autoclaved aerated concrete and anchored by bonding.

Chemofast ResiTHERM[®] 12 and Chemofast ResiTHERM[®] 16 distance fixing systems consist of a M12 or M16 threaded rod respectively, which are made from carbon steel or stainless steel and a thermal separation module made from polyamide. The fixing system is placed into a pre-drilled hole perpendicular to the surface (maximum deviation 5°) in masonry or concrete, and anchored by bonding the threaded rod element to the wall of the drilled hole.

The product description is given in Annex A.

2 Specification of the intended use in accordance with the applicable European Assessment Document (hereinafter EAD)

The intended use is fixings through an ETICS into the loadbearing wall of heavy-duty fixtures such as awnings, French balconies, canopies, satellite dishes, etc.

The system is used for distance installations in the following insulated base materials:

- Normal weight cracked or non-cracked concrete (base material group a)
- Solid masonry bricks (base material group b)
- Perforated or hollow bricks (base material group c)
- autoclaved aerated concrete (base material group d)

Reference to base material group in EAD 330499-02-0604 and EAD 330076-00-0604.

Anchorage subject to: Static or quasi-static loads.

Temperature range:

- T1: - 40°C to + 40°C

max. temperature: short-term + 40°C
 long-term + 24°C

- T2: - 40°C to + 80°C

max. temperature: short-term + 80°C
 long-term + 50°C

The minimum and the maximum installation temperature are specified by the manufacturer within the above range.

Use categories in respect of use:

Category d/d: Use in dry masonry and concrete

Category w/w: Use in wet masonry only.

This ETA applies only where concrete or masonry members in which the distance fixing systems are embedded are subject to static or quasi static actions in tension, pressure, shear or combined tension and shear or pressure and shear or bending.

In case of a product use in ETICS or insulations, it must be ensured that no debris and remaining of ETICS or insulations influence the load bearing capacity in the base material.

The performances given in Section 3 are only valid if the anchor is used in compliance with the specifications and conditions given in Annex B1 to B5.

The provisions made in this European Technical Assessment are based on an assumed intended working life of the anchor of 50 years.

The indications given on the working life cannot be interpreted as a guarantee given by the producer or Assessment Body, but are to be regarded only as a means for choosing the right products in relation to the expected economically reasonable working life of the works.

3 Performance of the product and references to the methods used for its assessment

3.1 Characteristics of product

Safety in case of fire (BWR 2):

No Performance assessed

Safety in use (BWR 4):

Resistance of the M12 and M16 anchor rod respectively fixed with anchor adhesive in the base material masonry, and autoclaved aerated concrete:

The M12 and M16 rod respectively with material specification as stated in annex A5 are covered by the following ETAs based on EAD 330076-00-0604 which provides the relevant performances:

- ETA-20/0557 (Chemofast VK or VK Nordic)
- ETA-20/0051 (Chemofast VECO)
- ETA-12/0341 (Chemofast PASF)
- ETA-12/0536 (Chemofast EASF)

Resistance of the M12 and M16 anchor rod respectively fixed with injection mortar in the base material concrete: The M12 and M16 rod respectively with material specification as stated in annex A5 are covered by the following ETAs based on EAD 330499-01-0601 which provides the relevant performances:

For cracked and uncracked concrete

- ETA-08/0237 (Chemofast VK oder VK Nordic)
- ETA-19/0402 (Chemofast VECO)

For uncracked concrete:

- ETA-12/0106 (Chemofast EASF)
- ETA-11/0285 (Chemofast PASF)
- ETA-12/0111 (Chemofast EA)
- ETA-11/0286 (Chemofast PA)

Resistance of the plastic part

- Characteristic resistance of the plastic part transferring load to failure under tension loading
- Characteristic resistance of the plastic part transferring load to failure under pressure loading
- Characteristic resistance of the plastic part transferring load to failure under shear loading
- Characteristic resistance to failure under pressure load and displacement (buckling of cantilever arm)
- Characteristic resistance to failure under combined shear and pressure load and displacements (buckling of cantilever arm)
- Characteristic resistance under shear loads and displacements (failure of plastic part transferring load, cantilever arm)
- Maximum installation torque moment

The above essential characteristics are detailed in Annex C.

Energy economy and heat retention (BWR6)

- Point thermal transmittance
- Equivalent thermal conductivity

The above essential characteristics are detailed in Annex C.

Durability

The verification of durability is part of testing of the essential characteristics. Durability is only ensured if the specifications of intended use according to Annex B are taken into account.

3.2 Methods of assessment

The assessment of fitness of the anchor for the intended use in relation to the requirements for mechanical resistance and stability and safety in use in the sense of the Basic Requirements 4 has been made in accordance with the EAD 331985-01-0604 – Distance fixing system.

4 Assessment and verification of constancy of performance (AVCP)

4.1 AVCP system

According to the decision 97/463/EC of the European Commission, the system(s) of assessment and verification of constancy of performance (see Annex V to Regulation (EU) No 305/2011) is 2+.

5 Technical details necessary for the implementation of the AVCP system, as foreseen in the applicable EAD

Technical details necessary for the implementation of the AVCP system are laid down in the control plan deposited at ETA-Danmark prior to CE marking.

Issued in Copenhagen on 2022-09-12 by



Thomas Bruun

Managing Director, ETA Danmark

Distance fixing system ResiTHERM® 12

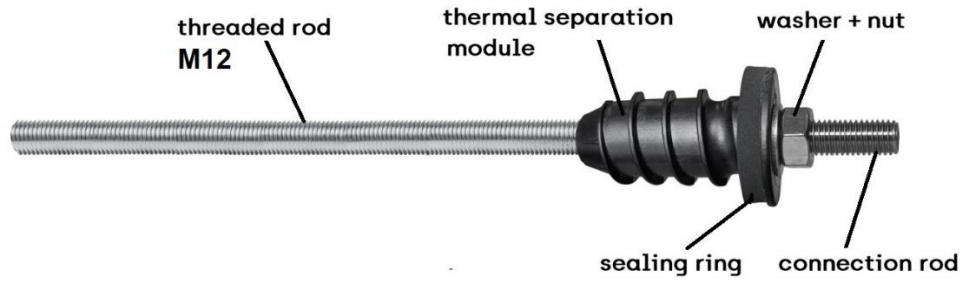

Distance fixing system ResiTHERM® 16

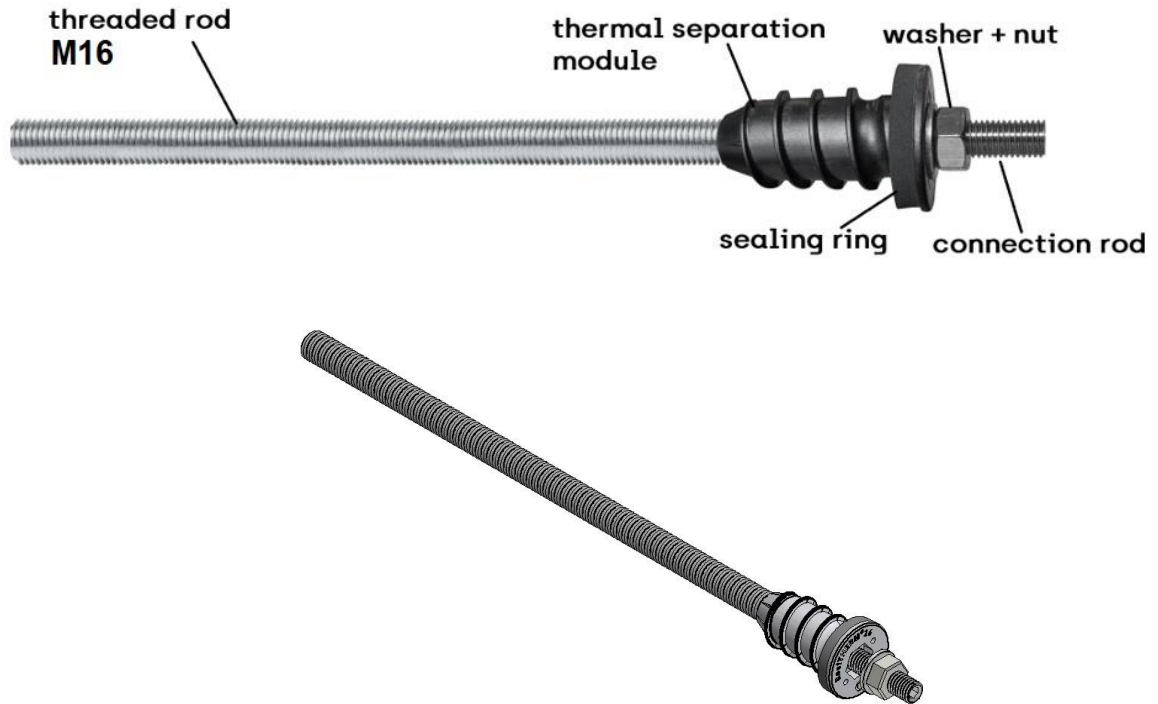

ResiTHERM® 12, ResiTHERM® 16

Product description
View and profile of the products

Annex A1

ResiTHERM® 12, ResiTHERM® 16 installed conditions

Single fixing – anchor’s free end is rotatable under an acting shear load

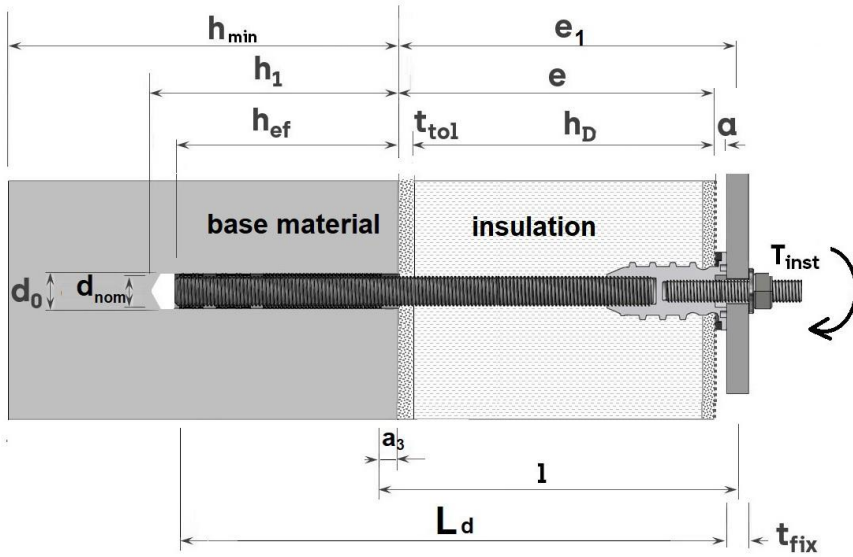

Multiple fixing – anchor’s free end is not rotatable under an acting shear load, provided that the fixed baseplate is sufficiently rigid

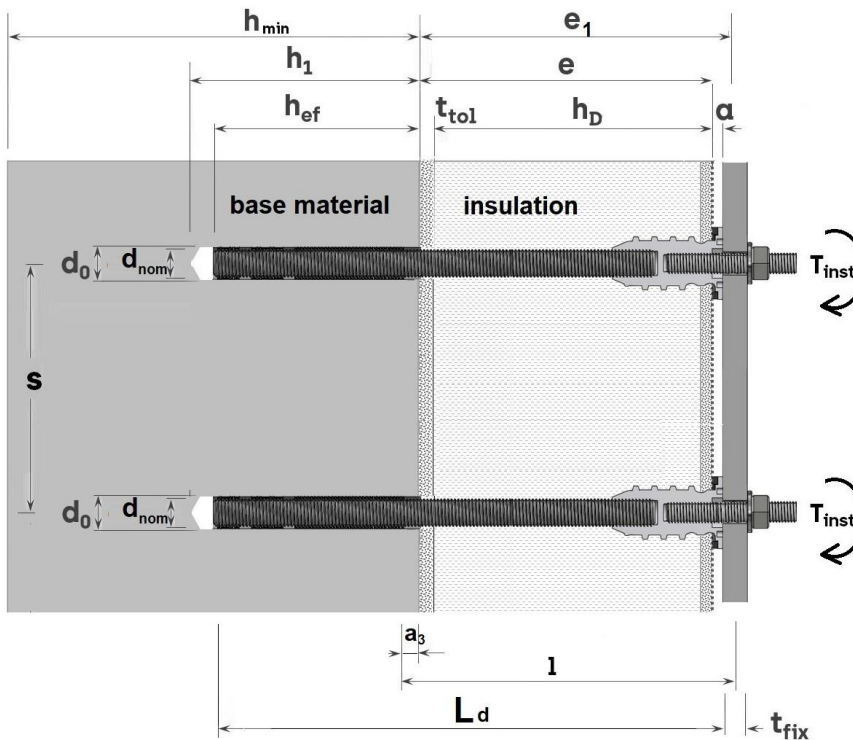

ResiTHERM® 12, ResiTHERM® 16

Product description
Installed conditions single fixing and multiple fixings

Annex A2

ResiTHERM® 12 installed conditions

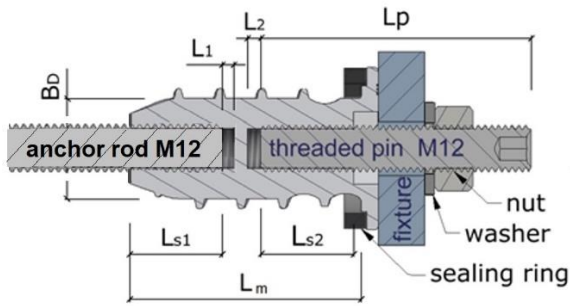

ResiTHERM® 16 installed conditions

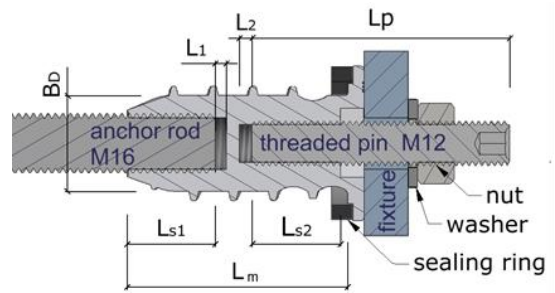

Table A3.1: Specifications for the installation

			ResiTHERM® 12	ResiTHERM® 16
Total length incl. anchor rod	L_d	[mm]	≤ 302	≤ 392
Length of the thermal separation module	L_m	[mm]	60	
Core diameter of the thermal separation module	B_D	[mm]	26	
Diameter cover disc	K_D	[mm]	42	
Diameter of anchor rod	d_{nom}	[mm]	12	16
Thickness of non-load bearing plaster, adhesive or similar materials	t_{tol}	[mm]	optional	optional
Insulation thickness (incl. insulation plaster)	h_D	[mm]	60 - 220	60 - 300
Lever arm for shear load for calculation of shear load with lever arm	l	[mm]	$a_3 + e_1$	
Distance between surface of base material to the plaster surface (non bearing materials)	e	[mm]	$h_D + t_{tol}$	
Distance between shear load and surface of the base material	e_1	[mm]	$e + a + t_{fix} / 2$	
Gap between plaster surface and fixture	a	[mm]	3 – 3,5	
Additional length for lever arm	a_3	[mm]	$0,5 * d_{nom}$	
Min. screw-in depth M12 or M16 anchor rod	L_{s1}	[mm]	24	
Min. screw-in depth M12 (pin)	L_{s2}	[mm]	24	
Adjusting length M12 or M16 anchor rod (base material side)	L_1	[mm]	3	
Adjusting length M12 pin (fixture side)	L_2	[mm]	3,5	
Spacing between anchor rods	s	[mm]	in accordance with ETA of anchor adhesive	

ResiTHERM® 12, ResiTHERM® 16

Product description
Installed conditions

Annex A3

ResiTHERM® 12, ResiTHERM® 16 installed conditions to ensure sealing against driving rain (watertightness in accordance with EN 1027 – method 1A)

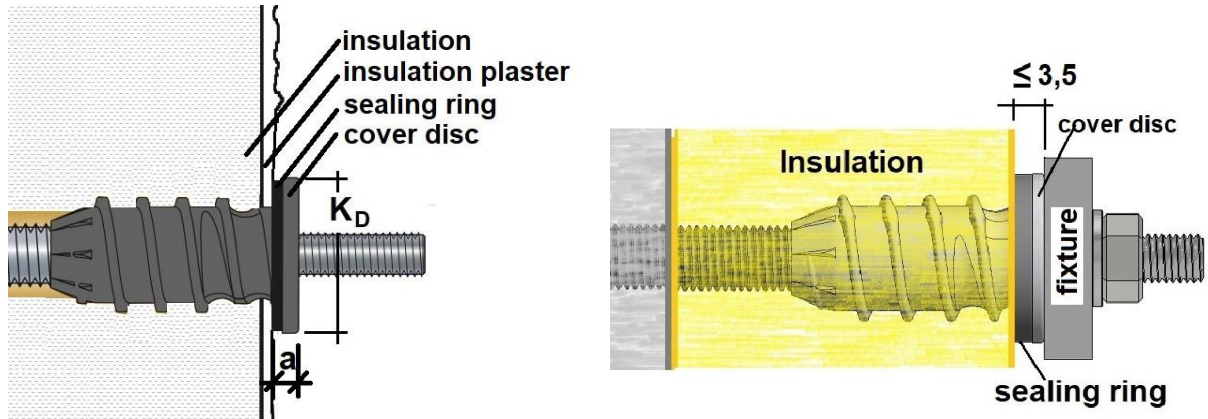

Installation with max. distance of plaster to fixture to ensure water tightness ($a \leq 3,5$ mm)

Marking:

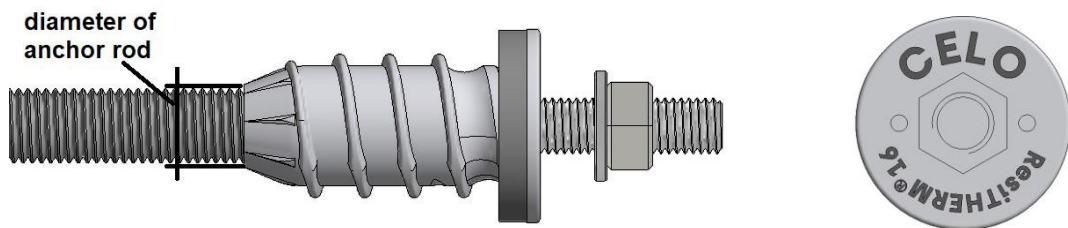

Marking:	Brand	Type	diameter of anchor rod
Example:	CELO	ResiTHERM®	16 resp. 12

ResiTHERM® 12, ResiTHERM® 16

Product description
Installed conditions for driving rain tightness. Marking.

Annex A4

ResiTHERM® 12, ResiTHERM® 16 single parts and materials

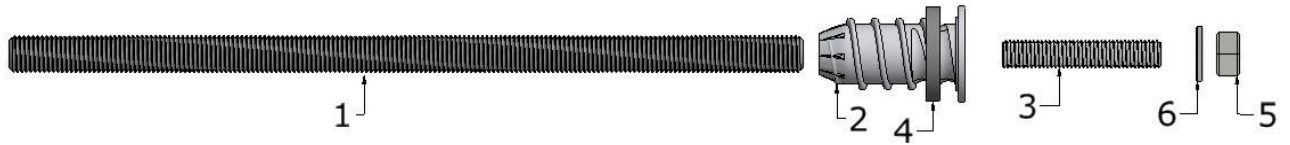

Accessories:



M12

M10

Pos 3a



Pos 7

Table A 5.1: Parts and Materials

Pos	Designation	Material
1	Anchor rod M12 or Anchor rod M16	Steel zinc plated galvanised $\geq 5\mu\text{m}$ in accordance with EN ISO 4042:2018 Property class EN-ISO 898-1 (2013) $f_{yk} \geq 640 \text{ N/mm}^2$, $f_{uk} \geq 800 \text{ N/mm}^2$ or stainless steel A4 in accordance with EN 10088-3:2014 material 1.4401 or 1.4571 ($f_{yk} \geq 450 \text{ N/mm}^2$, $f_{uk} \geq 700 \text{ N/mm}^2$, strength class 70)
2	Thermal separation module	Polyamide PA 6 with glass fiber
3	Threaded pin M12 or alternative	Stainless steel A4 in accordance with EN 10088-3:2014 material 1.4401 or 1.4571 $f_{yk} \geq 450 \text{ N/mm}^2$, $f_{uk} \geq 700 \text{ N/mm}^2$
3a	reduction threaded pin M12/M10	
3b	or M12 screw	
4	sealing ring	Material: EPDM (min. 41,5 x 37,5 x 6 mm ³)
5	Hexagon nut M12	Stainless steel A4 in accordance with EN 10088-3:2014 material 1.4401 or 1.4571 in accordance with DIN EN ISO 4032
6	Washer	Stainless steel A4 in accordance with DIN 125 or 440
7	Optional: distance washer for M12, in accordance with DIN 9021	Polyamide, 37 x 13 x 3 mm (white or black)

ResiTHERM® 12, ResiTHERM® 16

Product description
Single parts and material

Annex A5

Specification of intended use

Anchorage subject to:

- Static and quasi-static actions in tension, pressure, shear or combined tension and shear or combined pressure and shear load. The anchor shall not be used for the transmission of dead loads of the thermal insulation composite system.

Base material:

Masonry and autoclaved aerated concrete – in accordance with ETA’s

- ETA-20/0557 (Chemofast VK or VK Nordic)
- ETA-20/0051 (Chemofast VECO)
- ETA-12/0341 (Chemofast PASF)
- ETA-12/0536 (Chemofast EASF)

Cracked and uncracked concrete – in accordance with ETA’s

- ETA-08/0237 (Chemofast VK or VK Nordic)
- ETA-19/0402 (Chemofast VECO)

uncracked concrete – in accordance with ETA’s for uncracked concrete

- ETA-12/0106 (Chemofast EASF)
- ETA-11/0285 (Chemofast PASF)
- ETA-12/0111 (Chemofast EA)
- ETA-11/0286 (Chemofast PA)

Temperature Range for use- if not restricted by injection adhesive ETA:

Masonry

- T_a: - 40°C to + 40°C (max. temperature: short-term +40°C and long-term +24°C)
- T_b: - 40°C to + 80°C (max. temperature: short-term +80°C and long-term +50°C)

Concrete

- T1: - 40°C to + 40°C (max. temperature: short-term +40°C and long-term +24°C)
- T2: - 40°C to + 80°C (max. temperature: short-term +80°C and long-term +50°C)

Use conditions (Environmental conditions)

The use conditions for the base materials are given in the above-mentioned ETA’s for the respective substrates.

ResiTHERM® 12, ResiTHERM® 16

Product description
Specification of intended use

Annex B1

Steel parts in respect of installation and application conditions:

The intended use regarding environmental conditions of anchors with components made of stainless steel, results from their corrosion resistance class in accordance with (CRC) to EN 1993-1-4:2006+A1:2015, Table A.3 in connection with EN 1993-1-4:2006+A1:2015, Table A.2 and A.1.

- The fastener consisting of exterior and interior parts made of stainless-steel class A4 in accordance with Annex A5, table A5.1: CRC III.
- The fastener consisting of exterior parts made of stainless-steel class A4 in accordance with Annex A5, table A5.1 and interior parts made of galvanized carbon steel in accordance with Annex A5, table A5.1: CRC III, provided that the anchor and sealing ring is installed in accordance with Annex A4 and with displacement less than 1.0 mm under tension loads and less than 3.0 mm under shear loads, and with a render with a maximum grain size K3.
- Furthermore, it is required that the ETICS or insulation is designed to avoid accumulation of humidity. The fastener consisting of exterior parts made of stainless-steel class A4 according to Annex A5, table A5.1 and interior parts made of galvanized carbon steel in accordance with Annex A5, table A5.1: CRC III, provided that other suitable sealing measures are taken, such as a hybrid joint compound or e.g., a sheet metal cover is applied.

Use conditions in respect of installation and use

Masonry and aerated autoclaved concrete base material - if not restricted by the injection mortar ETA:

- Category d/d: Installation and use in dry masonry
- Category w/w: Installation and use in wet or dry masonry (incl. w/d installation in wet masonry and use in dry masonry)

Concrete base material - if not restricted by the injection mortar ETA:

- I1: installation in dry or wet (water saturated) concrete and use in dry or wet concrete
- I2: installation in water-filled drill holes (not sea water) and use in dry or wet concrete
- D3: downward and horizontal and upwards (e.g. overhead) installation

ResiTHERM® 12, ResiTHERM® 16

Product description
Specification of intended use

Annex B2

Design:

- The anchorages are to be designed under the responsibility of an engineer experienced in anchorages and masonry work with the applicable safety factors.
- Verifiable calculation notes and drawings shall be prepared taking account of the loads to be anchored, the nature and strength of the base materials and the dimensions of the anchorage members as well as of the relevant tolerances. The position of the anchor is indicated on the design drawings.
- The fastener is anchored in the substrate of concrete, masonry or autoclaved aerated concrete. Any other layer, e.g. tolerance levelling layers, adhesives, plaster covering the substrate or outside plasters are considered as to be non load bearing.
- Anchorages in concrete under static or quasi-static actions are designed in accordance with EN 1992-4:2018-09
- Anchorages in masonry under static or quasi-static actions are designed in accordance with EOTA TR 054:2016
- The anchorage design outside the base material shall be done in accordance with EOTA TR 077:2021
- $\alpha_{\text{pressure}} = 1$ for compression load for solid base material and for hollow base material with more than 4 penetrated webs.

Installation:

- Dry or wet structures
- Anchor Installation carried out by appropriately qualified personnel and under the supervision of the person responsible for technical matters of the site.
- Hole drilling in concrete by hammer or compressed air drill mode
- Temperature of the anchor system at installation from -20°C to + 40°C.
- Exposure to UV due to solar radiation of the plastic part not protected ≤ 6 weeks.

<p>ResiTHERM® 12, ResiTHERM® 16</p>	<p>Annex B3</p>
<p>Product description Specification of intended use</p>	

Table B 2.1: Installation parameters in base material (see drawing in Annex A2)

Anchor type			ResiTHERM® 12	ResiTHERM® 16
Insulation thickness incl. insulation plaster	h_D	[mm]	60 - 220	60 - 300
Min. thickness of member	h_{min}	[mm]	in accordance with anchor adhesive ETA	
Effective anchorage depth	$h_{ef} \geq$	[mm]		
Drill hole diameter	d_0	[mm]		
Depth of drill hole in the base material	$h_1 \geq$	[mm]		
Diameter of clearance hole in the fixture for the M12 threaded pin	$d_f \geq$	[mm]	13	13
Diameter of clearance hole in the fixture for the M12/M10 threaded pin	$d_f \geq$	[mm]	11	11
Length of threaded pin	$L_p \geq$	[mm]	50	50
Thickness of fixture	t_{fix}	[mm]	0 – 24 ^{a)} max. 200 ^{b)}	0 – 24 ^{a)} max. 200 ^{b)}
Installation torque to fix the fixture *	$T_{inst} \leq$	[Nm]	19	25

For hollow base material perforated sleeves must be used for the anchor adhesive, in accordance with ETA of anchor adhesive.

* $T_{inst} = 19 \text{ Nm}$ resp. 25 Nm are valid for the thermal separation module. Max. T_{inst} given in ETAs of anchor adhesive must also be observed.

^{a)} as delivered with threaded pin M12 or with reduction threaded pin M12/M10

^{b)} with any longer threaded rod, washer and nut which complies to the specifications given in table A 5.1 position 3 and 3a. The introduction of bending moment is not allowed. Constructive measures must be applied to exclude any bending moment

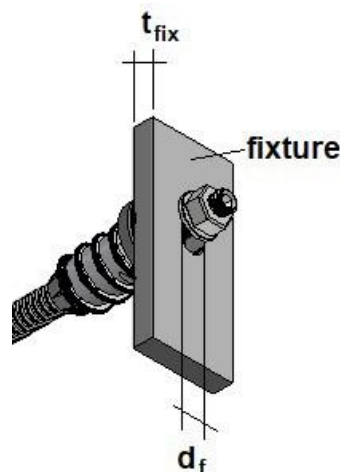

ResiTHERM® 12, ResiTHERM® 16

Intended use
Installation parameters

Annex B4

ResiTHERM® 12, ResiTHERM® 16: Installation instruction (in concrete or solid masonry)

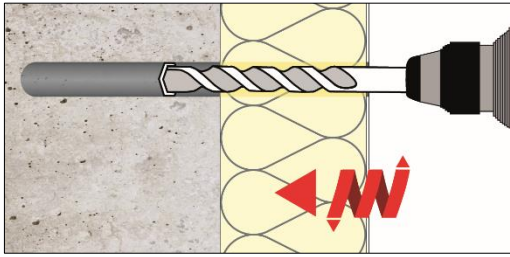

1. Drill a hole

Observe the drilling method of the ETA of the Chemofast injection mortar.

Concrete/solid brick: hammer drilling
Aerated concrete: Rotary drilling - without impact

ResiTHERM®	Drill hole diameter d_0	Drill hole depth h_1	
		concrete	solid brick & AAC
12	14 mm	$\geq 80 \text{ mm} + e$	$\geq 110 \text{ mm} + e$
16	18 mm	$\geq 90 \text{ mm} + e$	

(e = insulation thickness incl. plaster & t_{ol})

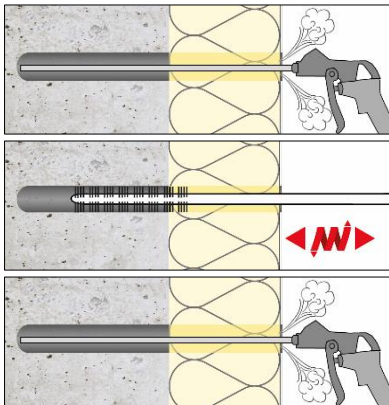

2. Clean the drill hole

The drill hole must be cleaned properly (see ETA of the Chemofast injection mortar)

4x blow – 4x brush – 4x blow

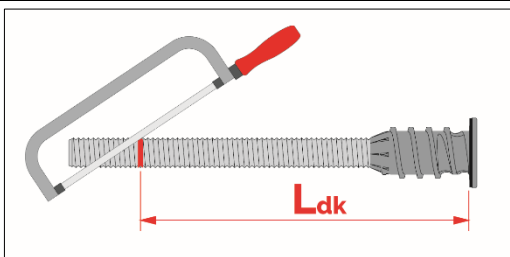

3. Cut the ResiTHERM® to length

The pre-assembled threaded rod M12 or M16 is already completely screwed into the thermal separation module.

Correct length L_{dk} from the tip of the threaded rod to the lower edge of the cover plate of the thermal separation module (see table):

ResiTHERM®	Correct length: $L_{dk} = h_{ef} + e$	
	concrete	solid brick & AAC
12	$\geq 70 \text{ mm} + e$	100 mm + e
16	$\geq 80 \text{ mm} + e$	

(e = insulation thickness incl. plaster & t_{ol})

After determining the correct length, cut the threaded rod to length with a metal saw or similar.

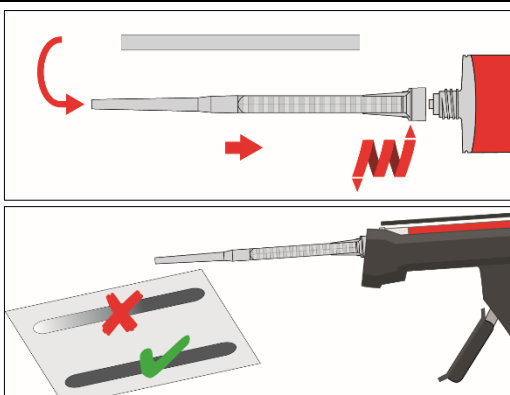

4. Injection mortar

Attach the mixing nozzle extension to the mixing nozzle.

Squeeze out the injection mortar until the mortar has a uniform grey mixing colour - discard the pre-run of at least 3 full strokes.

ResiTHERM® 12, ResiTHERM® 16

Intended use

Installation instruction in solid base material

Annex B5

ResiTHERM® 12, ResiTHERM® 16: Installation instruction (in concrete or solid masonry)

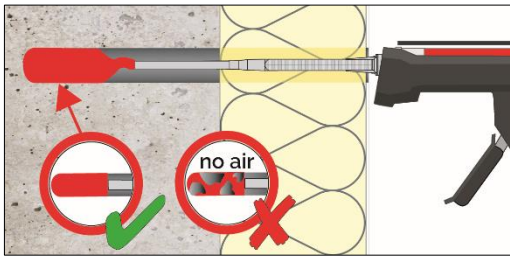

5. Fill the drill hole with injection mortar

(start from the bottom of drill hole):

ResiTHERM® 12 and 16	Number of strokes (scales)		
	165/280/300ml	345ml	410ml
Concrete	5	5	4-5
Solid brick / AAC	6	6	5-6

Important: Follow the installation instructions and processing time of the ETA of the Chemofast injection mortar used.

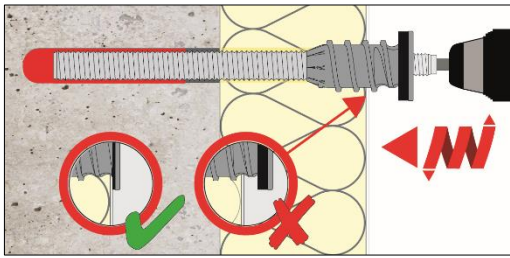

6. Installation of the ResiTHERM® 12 or 16

Insert the hexagon bit (included in the set) into the M12 threaded stud and screw in the ResiTHERM® 12 or 16 using a cordless screwdriver until the sealing ring is pressed firmly against the plaster. A standard cordless screwdriver is sufficient for this.

Note: The thermal separation module drills itself through the insulation. The foamed EPDM sealing ring ensures optimum sealing and prevents the entry of driving rain into the insulation (installation conditions see Annex B1, B2)

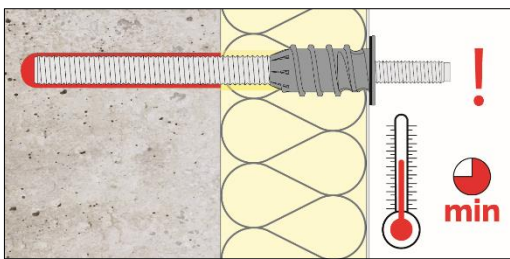

7. Curing time

Observe the curing time of the injection system, see cartridge label of the Chemofast injection mortar.

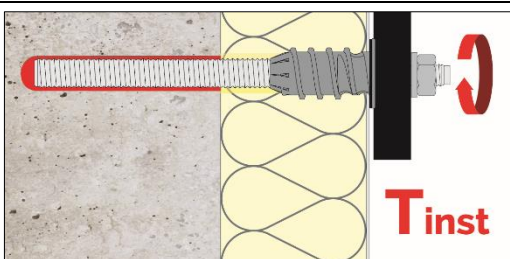

8. Mounting of the fixture

Afterwards, the attachment can be mounted (**ResiTHERM® 12:** max. torque $T_{inst} = 19 \text{ Nm}$, **ResiTHERM® 16:** max. torque $T_{inst} = 25 \text{ Nm}$, see annex B4).

Note: Observe an eventually varying installation torque in the ETA of the used Chemofast injection system.

Note: The screw insertion depth of the M12 threaded stud in the ResiTHERM® 12 or 16 is min. 30 mm, max. 34 mm (measured from outside of the cover plate).

This means, that it can be unscrewed by max. 4 mm, this corresponds to approx. 2 turns.

ResiTHERM® 12, ResiTHERM® 16

Intended use
Installation instruction in solid base material

Annex B6

ResiTHERM® 12, ResiTHERM® 16: Installation instruction (in hollow masonry)

The mounting instruction uses as an example a sleeve 20-130 (diameter 20 mm with length 130 mm). Any sleeve according to the ETA of the Chemofast injection mortar from Annex B1 can be used.

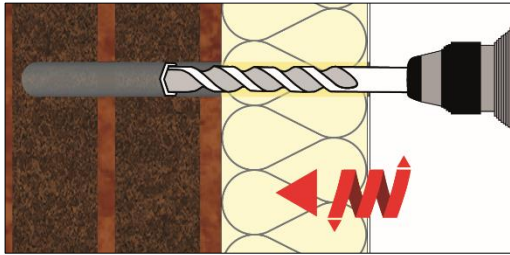

1. Drill a hole

Observe the drilling method of the ETA of the Chemofast injection mortar.

Perforated bricks: Rotary drilling without impact.

ResiTHERM® 12 and ResiTHERM® 16:

Drill hole diameter $d_0 = 20 \text{ mm}$

Drill hole depth $h_1 \geq 140 \text{ mm} + e$

(e = insulation thickness incl. plaster & t_{tol})

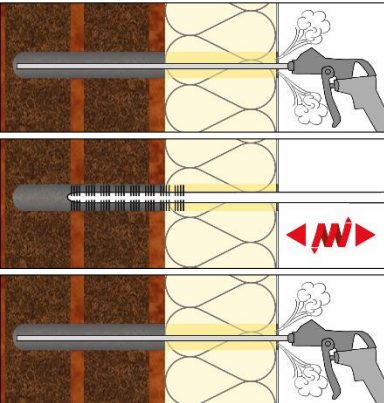

2. Clean the drill hole

The drill hole must be cleaned properly

(see ETA of the Chemofast injection mortar)

2x blow – 2x brush – 2x blow

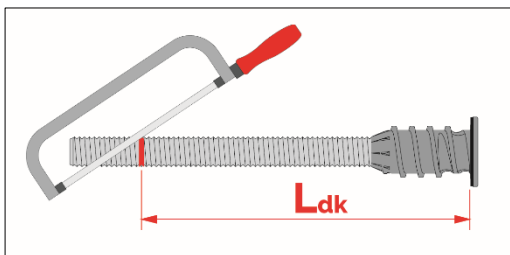

3. Cut the ResiTHERM® to length

The pre-assembled threaded rod M12 or M16 is already completely screwed into the thermal separation module. Correct length L_{dk} from the tip of the threaded rod to the lower edge of the cover plate of the thermal separation module:

Anchorage depth in plastic sleeve (125 mm) + e (insulation thickness incl. plaster & t_{tol})

After determining the correct length, cut the threaded rod M12 or M16 to length with a metal saw or similar.

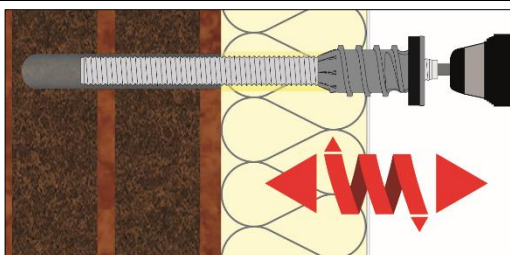

4. Enlarge the opening in the plaster

for the collar of the plastic sleeve to 26 mm.

To do this:

Screw the thermal separation module only approx. 2 thread turns through the plaster using a cordless screwdriver and the bit included in the set. Then screw it out again.

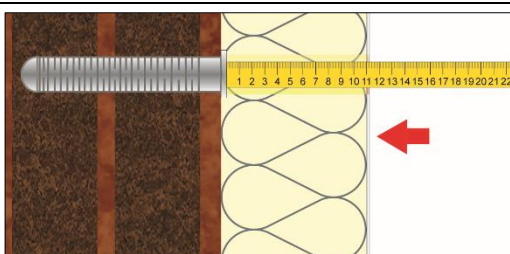

5. Insert plastic sleeve

Push the plastic sleeve into the drill hole with the help of a folding ruler or similar. Then remove the folding ruler or similar from the drill hole.

Note: This is an ideal way to ensure that the perforated sleeve SH 20x130 is correctly positioned in the drill hole.

ResiTHERM® 12, ResiTHERM® 16

Intended use

Installation instruction in hollow masonry

Annex B7

ResiTHERM® 12, ResiTHERM® 16: Installation instruction (in hollow masonry)

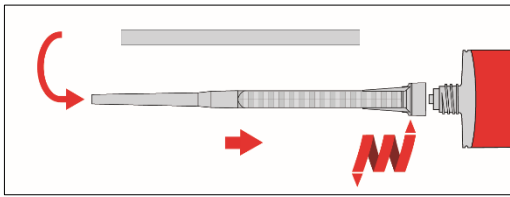

6. Injection mortar

Attach the mixing nozzle extension to the mixing nozzle. Squeeze out the injection mortar until the mortar has a uniform grey mixing colour - discard the pre-run of at least three full strokes.

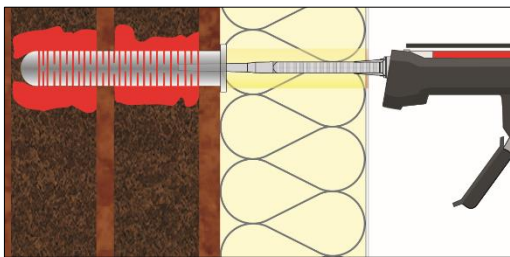
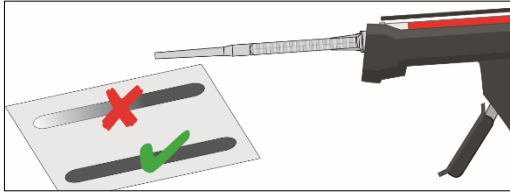

7. Fill the plastic sleeve

completely with injection mortar (start from the bottom/back of the sleeve):

ResiTHERM® 12 and 16	Number of strokes (scales)		
	165/280/300ml	345ml	410ml
Hollow brick	13 (38mm)	12 (34mm)	13 (24mm)

Important: Follow the installation instructions and processing time of the Chemofast injection mortar.

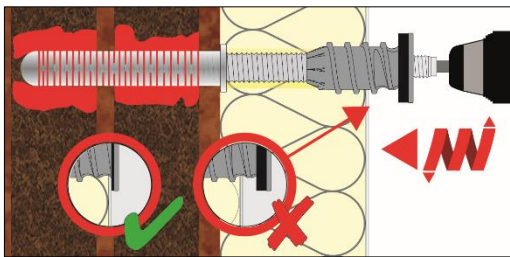

8. Installation of the ResiTHERM® 12 or 16

Insert the hexagon bit (included in the set) into the M12 threaded stud and screw in the ResiTHERM® 12 or 16 using a cordless screwdriver until the sealing ring is pressed firmly against the plaster. A standard cordless screwdriver is sufficient for this.

Note: The thermal separation module drills itself through the insulation. The foamed EPDM sealing ring ensures optimum sealing and prevents the entry of driving rain into the insulation (installation conditions see Annex B1, B2).

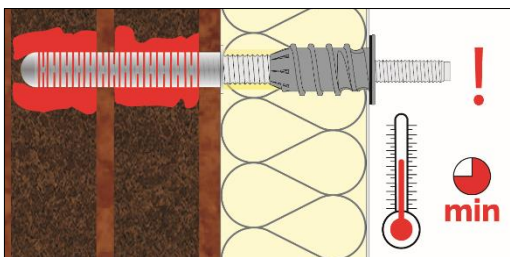

9. Curing time

Observe the curing time of the injection system, see cartridge label of the Chemofast injection mortar.

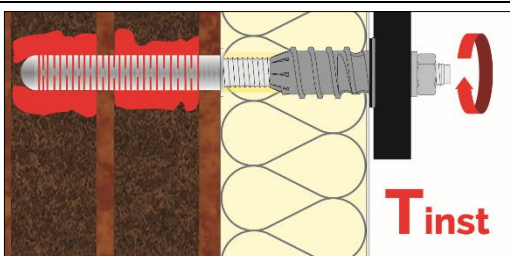

10. Mounting of the fixture

Afterwards, the attachment can be mounted

(ResiTHERM® 12: max. $T_{inst} = 19 \text{ Nm}$,

ResiTHERM® 16: max. $T_{inst} = 25 \text{ Nm}$, see annex B4).

Note: Observe an eventually varying installation torque in the ETA of the used Chemofast injection system.

Note: The screw insertion depth of the M12 threaded stud in the ResiTHERM® 12 or 16 is min. 30 mm, max. 34 mm (measured from outside of the cover plate).

This means, that it can be unscrewed by max. 4 mm, this corresponds to approx. 2 turns.

ResiTHERM® 12, ResiTHERM® 16

Intended use
Installation instruction in hollow masonry

Annex B8

Table B9.1: Conditions for proper installation and additional advice for installation

Note: Driving rain resistance must be designed in accordance with the provisions given in Annex B2 for fasteners with an interior part made of galvanized steel.

ResiTHERM® 12, ResiTHERM® 16					
ETICS with insulation panels made of					
		XPS EPS	Mineral wool, compression strength ≥ 5 kPa**	wood fiber, raw density ≤230kg/m ³ and compression strength ≤ 100 kPa	wood fiber, raw density >230kg/m ³ or compression strength > 100 kPa
ETICS rendered with plaster	≤8 mm rendering thickness	Standard installation in accordance with annex B5, B6, B7 and B8			Drill the hole through the insulation and in the base material with a regular drill bit. Afterwards, enlarge the hole in the plaster and insulation to diameter 26 mm to a depth of 60 mm. For this purpose a wood drill bit may be used.
	>8 mm rendering thickness	Drill the hole through the insulation and in the base material with a regular drill bit. Afterwards, enlarge the hole in the plaster to d=26 mm by using e.g. a wood drill bit.			

* External Thermal Insulations Composite Systems (ETICS) or rendered insulation with reinforced plaster which are glued only or glued and mechanically fixed.

** ≥ 5 kPa is a guideline value that the thermal separation module can apply sufficient pre-tensioning force in the insulation panel to ensure the compression of the sealing ring.

The values stated are to be understood as guideline values in order to give the user the highest possible application safety.

ResiTHERM® 12, ResiTHERM® 16

Intended use

Conditions for proper installation and additional advice for installation

Annex B9

Table C1.1: Characteristic tensile load resistance $N_{Rk,s}$ of the anchor rods

ResiTHERM® 12, ResiTHERM® 16				
Type	Cross section of anchor rod	Nominal tensile strength of anchor rod	Char. tensile load resistance	safety factor
	A_s	f_{uk}	$N_{Rk,s}$	γ_{Ms}^*
	[mm ²]	[N/mm ²]	[kN]	[-]
ResiTHERM® 12 (M12 rod 8.8, carbon steel)	84,3	800	67,4	1,50
ResiTHERM® 12 (M12 rod A4-70)	84,3	700	59,0	1,87
ResiTHERM® 16 (M16 rod 8.8, carbon steel)	157,0	800	125,6	1,50
ResiTHERM® 16 (M16 rod A4-70)	157,0	700	109,9	1,87

$$N_{Rk,s} = A_s * f_{uk}$$

*In absence of other national regulations

Table C1.2: Characteristic shear load resistance $V_{Rk,s}$ without lever arm and characteristic bending resistance $M_{Rk,s}$ of the anchor rods

ResiTHERM® 12, ResiTHERM® 16			
Type	Char. shear load resistance	Char. bending resistance	safety factor
	$V_{Rk,s}$	$M_{Rk,s}$	γ_{Ms}^*
	[kN]	[Nm]	[-]
ResiTHERM® 12 (M12 rod 8.8, carbon steel)	33,7	104,7	1,25
ResiTHERM® 12 (M12 rod A4-70)	29,5	91,6	1,56
ResiTHERM® 16 (M16 rod 8.8, carbon steel)	62,8	265,5	1,25
ResiTHERM® 16 (M16 rod A4-70)	55,0	232,3	1,56

$$V_{Rk,s} = 0,5 * A_s * f_{uk}$$

$$M_{Rk,s} = 1,2 * W_{el} * f_{uk} \quad \text{with} \quad W_{el} = \pi * d_s^3 / 32$$

for M16: $d_s = 14,14$ mm for M12: $d_s = 10,36$ mm

*In absence of national regulations

ResiTHERM® 12, ResiTHERM® 16

Performances

Characteristic tensile load, shear load and bending moment of anchor rod

Annex C1

Table C2.1: Characteristic buckling load resistance $P_{Rk,ca}$ for the system of threaded rod and thermal separation module under pressure load with or without shear load displacement (δ_v)

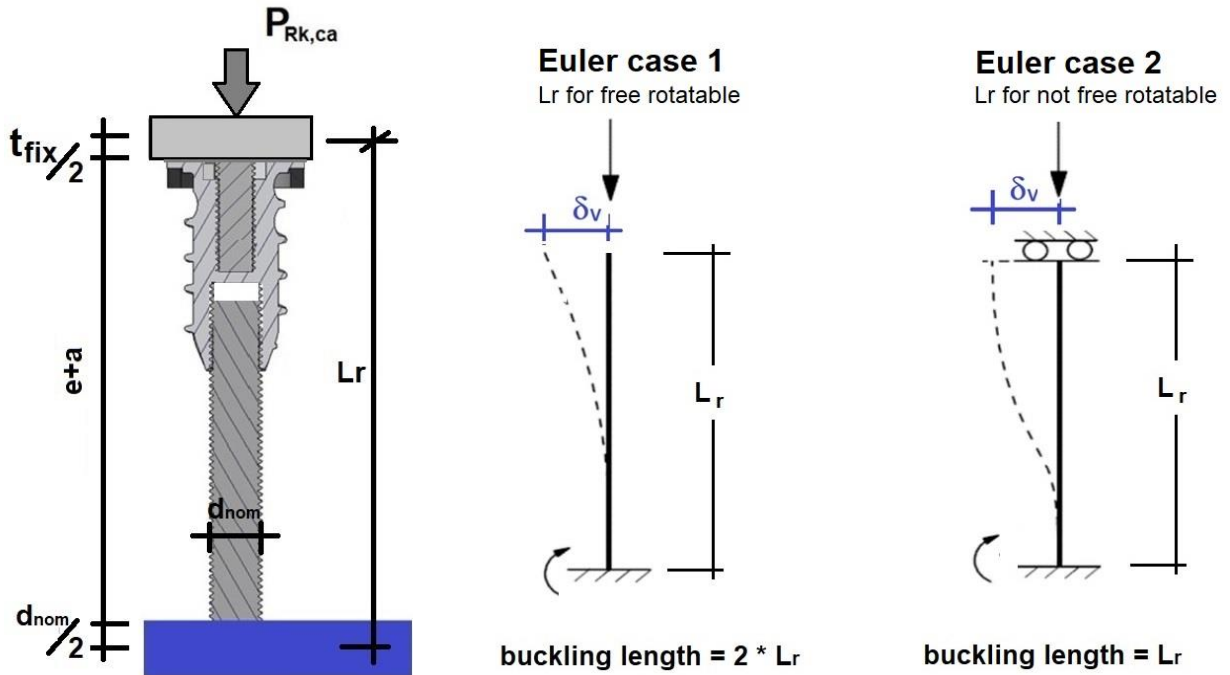

ResiTHERM® 12, ResiTHERM® 16						
Type	Insulation thickness (incl. insulation plaster and t_{tot})	Max. shear load displacement		Free rotatable (Euler case 1)	Not free rotatable (Euler case 2)	Safety factor
	h_D	δ_v	L_r	Char. buckling load resistance	Char. buckling load resistance	γ_{Mca}^*
	[mm]	[mm]	[mm]	$P_{Rk,ca}$ [kN]	$P_{Rk,ca}$ [kN]	[-]
ResiTHERM 12	60 - 120	5	136,4	$\geq 15,8^{**}$	$\geq 25,2$	1,3
ResiTHERM 12	121 - 160	5	176,4	$\geq 9,4^{**}$	$\geq 25,2$	1,3
ResiTHERM 12	161 - 220	5	236,4	$\geq 5,2^{**}$	$\geq 21,0^{**}$	1,3
ResiTHERM 16	60 - 220	5	238,4	$\geq 17,9^{**}$	$\geq 22,7$	1,3
ResiTHERM 16	221 - 300	5	318,4	$\geq 10,0^{**}$	$\geq 22,7$	1,3

* γ_{Mca} for buckling in accordance with TR 077

** calculated values in accordance with Euler cases were decisive for the determination of performance

ResiTHERM® 12, ResiTHERM® 16

Performances
Characteristic buckling load under pressure load

Annex C2

Table C3.1: Characteristic tensile load resistance N_{Rk} against short- and long-term acting loads for the thermal separation module

ResiTHERM® 12, ResiTHERM® 16		
Type	24°C/40°C and 50°C/80°C	safety factor
	N_{Rk}	γ_{Mtk}^*
	[kN]	[-]
ResiTHERM® 12	18	2,5
ResiTHERM® 16	16	2,5

* γ_{Mtk} for plastic material Polyamide in accordance with TR 077

The min. screw in depths of the rods (L_{s1} , L_{s2}) must be observed

Table C3.2: Characteristic pressure load resistance P_{Rk} against short- and long-term acting loads for thermal separation module

ResiTHERM® 12, ResiTHERM® 16		
Type	24°C/40°C and 50°C/80°C	safety factor
	P_{Rk}	γ_{Mtk}
	[kN]	[-]
ResiTHERM® 12	18	2,5
ResiTHERM® 16	18	2,5

* γ_{Mtk} for plastic material Polyamide in accordance with TR 077

Pressure load in base material must be considered

ResiTHERM® 12, ResiTHERM® 16

Performances

Characteristic tensile and pressure resistance of separation module

Annex C3

Table C4.1: Characteristic shear load resistance $V_{Rk,pol}$ against short- and long-term acting loads for a single thermal separation module - free end rotatable

ResiTHERM® 12, ResiTHERM® 16					
					free end rotatable
Type	short-term 24°C/40°C	long-term 24°C/40°C	short-term 50°C/80°C	long-term 50°C/80°C	Safety factor
	$V_{Rk,pol}$	$V_{Rk,pol}$	$V_{Rk,pol}$	$V_{Rk,pol}$	γ_{Mtk}
	[kN]	[kN]	[kN]	[kN]	[-]
ResiTHERM® 12	5,0	5,0	5,0	3,5	2,5
ResiTHERM® 16	6,5	6,5	6,5	4,5	2,5

Table C4.2: Characteristic shear load resistance $V_{Rk,pol}$ against short- and long-term acting loads for a single thermal separation module - free end not rotatable

ResiTHERM® 12, ResiTHERM® 16					
					free end rotatable
Type	short-term 24°C/40°C	long-term 24°C/40°C	short-term 50°C/80°C	long-term 50°C/80°C	Safety factor
	$V_{Rk,pol}$	$V_{Rk,pol}$	$V_{Rk,pol}$	$V_{Rk,pol}$	γ_{Mtk}
	[kN]	[kN]	[kN]	[kN]	[-]
ResiTHERM® 12	5,0	5,0	5,0	3,5	2,5
ResiTHERM® 16	7,5	7,5	7,5	5,0	2,5

ResiTHERM® 12, ResiTHERM® 16

Performances

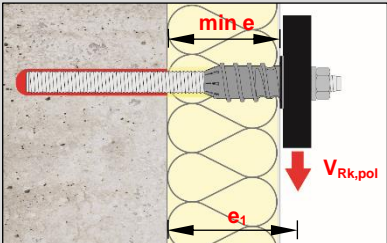
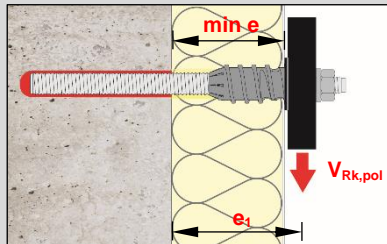
Char. shear load resistance for a single thermal separation module

Annex C4

Table C5.1: Shear load V values for single ResiTHERM® 12 for displacements w = 1, 2, 3, 4 or 5 mm, free end rotatable, under short-term acting load

ResiTHERM® 12 (free end rotatable; short-term acting load)										
For insulation thickness incl. insulation's plaster and t _{tol} if applicable	Temp. 24°C / 40°C Shear load V					Temp. 50°C / 80°C Shear load V				
	[kN]					[kN]				
	Deviation w					Deviation w				
[mm]	1 mm	2 mm	3 mm	4 mm	5 mm	1 mm	2 mm	3 mm	4 mm	5 mm
60	0,55	0,90	1,25	1,43	1,43	0,55	0,90	1,25	1,43	1,43
80	0,35	0,60	0,85	1,10	1,35	0,35	0,60	0,85	1,10	1,35
100	0,24	0,42	0,61	0,78	0,96	0,24	0,42	0,61	0,78	0,96
120	0,12	0,24	0,36	0,46	0,56	0,12	0,24	0,36	0,46	0,56
140	0,10	0,20	0,31	0,39	0,48	0,10	0,20	0,31	0,39	0,48
160	0,08	0,17	0,25	0,32	0,40	0,08	0,17	0,25	0,32	0,40
180	0,07	0,13	0,20	0,26	0,31	0,07	0,13	0,20	0,26	0,31
200	0,05	0,10	0,14	0,19	0,23	0,05	0,10	0,14	0,19	0,23
220	0,03	0,06	0,09	0,12	0,15	0,03	0,06	0,09	0,12	0,15

Intermediate values can be interpolated. Data are limited due to ultimate limit state verifications of the performance given in Annex C4 under consideration of $\gamma_M=2.5$ and $\gamma_F=1.4$

Table C5.2: Shear load V values for single ResiTHERM® 12 for displacements w = 1, 2, 3, 4 or 5 mm, free end rotatable, under long-term acting load

ResiTHERM® 12 (free end rotatable; long-term acting load)										
For insulation thickness incl. insulation's plaster and t _{tol} if applicable	Temp. 24°C / 40°C Shear load V					Temp. 50°C / 80°C Shear load V				
	[kN]					[kN]				
	Deviation w					Deviation w				
[mm]	1 mm	2 mm	3 mm	4 mm	5 mm	1 mm	2 mm	3 mm	4 mm	5 mm
60	0,55	0,90	1,25	1,43	1,43	0,39	0,63	0,88	1,00	1,00
80	0,35	0,60	0,85	1,10	1,35	0,25	0,42	0,60	0,77	0,95
100	0,24	0,42	0,61	0,78	0,96	0,16	0,29	0,42	0,55	0,67
120	0,12	0,24	0,36	0,46	0,56	0,08	0,17	0,25	0,32	0,39
140	0,10	0,20	0,31	0,39	0,48	0,07	0,14	0,21	0,27	0,33
160	0,08	0,17	0,25	0,32	0,40	0,06	0,12	0,18	0,23	0,28
180	0,07	0,13	0,20	0,26	0,31	0,05	0,09	0,14	0,18	0,22
200	0,05	0,10	0,14	0,19	0,23	0,03	0,07	0,10	0,13	0,16
220	0,03	0,06	0,09	0,12	0,15	0,02	0,04	0,06	0,08	0,11

Intermediate values can be interpolated/ Data are limited due to ultimate limit state verifications of the performance given in Annex C4 under consideration of $\gamma_M=2.5$ and $\gamma_F=1.4$

ResiTHERM® 12, ResiTHERM® 16

Performances
Displacement under shear load

Annex C5

Table C6.1: Shear load V values for a single ResiTHERM® 12 for displacements w = 1, 2, 3, 4 or 5 mm, free end not rotatable, under short-term acting load

ResiTHERM® 12 (free end <u>not</u> rotatable; short-term acting load)										
For insulation thickness incl. insulation's plaster and t _{tol} if applicable	Temp. 24°C / 40°C Shear load V					Temp. 50°C / 80°C Shear load V				
	[kN]					[kN]				
	Deviation w					Deviation w				
[mm]	1 mm	2 mm	3 mm	4 mm	5 mm	1 mm	2 mm	3 mm	4 mm	5 mm
60	1,30	1,43	1,43	1,43	1,43	1,30	1,43	1,43	1,43	1,43
80	0,77	1,43	1,43	1,43	1,43	0,77	1,43	1,43	1,43	1,43
100	0,57	1,09	1,43	1,43	1,43	0,57	1,09	1,43	1,43	1,43
120	0,36	0,70	1,01	1,27	1,43	0,36	0,70	1,01	1,27	1,43
140	0,31	0,59	0,85	1,07	1,29	0,31	0,59	0,85	1,07	1,29
160	0,25	0,48	0,69	0,88	1,06	0,25	0,48	0,69	0,88	1,06
180	0,20	0,37	0,54	0,68	0,82	0,20	0,37	0,54	0,68	0,82
200	0,14	0,27	0,38	0,48	0,59	0,14	0,27	0,38	0,48	0,59
220	0,08	0,16	0,22	0,29	0,35	0,08	0,16	0,22	0,29	0,35

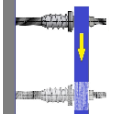

Intermediate values can be interpolated/ Data are limited due to ultimate limit state verifications of the performance given in Annex C4 under consideration of $\gamma_M=2.5$ and $\gamma_F=1.4$

Table C6.2: Shear load V values for a single ResiTHERM® 12 for displacements w = 1, 2, 3, 4 or 5 mm, free end not rotatable, under long-term acting load

ResiTHERM® 12 (free end <u>not</u> rotatable; long-term acting load)										
For insulation thickness incl. insulation's plaster and t _{tol} if applicable	Temp. 24°C / 40°C Shear load V					Temp. 50°C / 80°C Shear load V				
	[kN]					[kN]				
	Deviation w					Deviation w				
[mm]	1 mm	2 mm	3 mm	4 mm	5 mm	1 mm	2 mm	3 mm	4 mm	5 mm
60	1,30	1,43	1,43	1,43	1,43	0,91	1,00	1,00	1,00	1,00
80	0,77	1,43	1,43	1,43	1,43	0,54	1,00	1,00	1,00	1,00
100	0,57	1,09	1,43	1,43	1,43	0,40	0,76	1,00	1,00	1,00
120	0,36	0,70	1,01	1,27	1,43	0,25	0,49	0,71	0,89	1,00
140	0,31	0,59	0,85	1,07	1,29	0,21	0,41	0,60	0,75	0,91
160	0,25	0,48	0,69	0,88	1,06	0,18	0,34	0,49	0,61	0,74
180	0,20	0,37	0,54	0,68	0,82	0,14	0,26	0,38	0,48	0,58
200	0,14	0,27	0,38	0,48	0,59	0,10	0,19	0,27	0,34	0,41
220	0,08	0,16	0,22	0,29	0,35	0,06	0,11	0,16	0,20	0,25

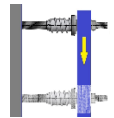

Intermediate values can be interpolated/ Data are limited due to ultimate limit state verifications of the performance given in Annex C4 under consideration of $\gamma_M=2.5$ and $\gamma_F=1.4$

ResiTHERM® 12, ResiTHERM® 16

Performances
Displacement under shear load

Annex C6

Table C7.1: Shear load V values for a single ResiTHERM® 16 for displacements w = 1, 2, 3, 4 or 5 mm, free end rotatable, under short-term acting load

ResiTHERM® 16 (free end rotatable; short-term acting load)										
For insulation thickness incl. insulation's plaster and t _{tol} if applicable	Shear load V Temp. 24°C / 40°C					Shear load V Temp. 50°C / 80°C				
	[kN]					[kN]				
	Deviation w					Deviation w				
[mm]	1 mm	2 mm	3 mm	4 mm	5 mm	1 mm	2 mm	3 mm	4 mm	5 mm
60	0,58	1,06	1,59	1,86	1,86	0,58	1,06	1,59	1,86	1,86
80	0,50	0,96	1,38	1,76	1,86	0,50	0,96	1,38	1,76	1,86
100	0,39	0,74	1,06	1,37	1,66	0,39	0,74	1,06	1,37	1,66
120	0,29	0,52	0,75	0,97	1,19	0,29	0,52	0,75	0,97	1,19
140	0,24	0,44	0,63	0,82	1,00	0,24	0,44	0,63	0,82	1,00
160	0,20	0,36	0,52	0,67	0,82	0,20	0,36	0,52	0,67	0,82
180	0,15	0,28	0,41	0,52	0,64	0,15	0,28	0,41	0,52	0,64
200	0,13	0,25	0,36	0,46	0,56	0,13	0,25	0,36	0,46	0,56
220	0,11	0,22	0,31	0,40	0,49	0,11	0,22	0,31	0,40	0,49
240	0,10	0,18	0,26	0,34	0,42	0,10	0,18	0,26	0,34	0,42
250	0,09	0,17	0,24	0,31	0,38	0,09	0,17	0,24	0,31	0,38
260	0,08	0,15	0,21	0,28	0,34	0,08	0,15	0,21	0,28	0,34
280	0,06	0,12	0,17	0,22	0,27	0,06	0,12	0,17	0,22	0,27
300	0,05	0,08	0,12	0,16	0,19	0,05	0,08	0,12	0,16	0,19

Intermediate values can be interpolated/ Data are limited due to ultimate limit state verifications of the performance given in Annex C4 under consideration of $\gamma_M=2.5$ and $\gamma_F=1.4$

Table C7.2: Shear load V values for a single ResiTHERM® 16 for displacements w = 1, 2, 3, 4 or 5 mm, free end rotatable, under long-term acting load

ResiTHERM® 16 (free end rotatable; long-term acting load)										
For insulation thickness incl. insulation's plaster and t _{tol} if applicable	Shear load V Temp. 24°C / 40°C					Shear load V Temp. 50°C / 80°C				
	[kN]					[kN]				
	Deviation w					Deviation w				
[mm]	1 mm	2 mm	3 mm	4 mm	5 mm	1 mm	2 mm	3 mm	4 mm	5 mm
60	0,58	1,06	1,59	1,86	1,86	0,41	0,75	1,11	1,30	1,30
80	0,50	0,96	1,38	1,76	1,86	0,35	0,67	0,97	1,23	1,30
100	0,39	0,74	1,06	1,37	1,66	0,27	0,52	0,74	0,96	1,16
120	0,29	0,52	0,75	0,97	1,19	0,20	0,36	0,52	0,68	0,83
140	0,24	0,44	0,63	0,82	1,00	0,17	0,31	0,44	0,58	0,70
160	0,20	0,36	0,52	0,67	0,82	0,14	0,25	0,36	0,47	0,57
180	0,15	0,28	0,41	0,52	0,64	0,10	0,20	0,28	0,37	0,45
200	0,13	0,25	0,36	0,46	0,56	0,09	0,17	0,25	0,32	0,39
220	0,11	0,22	0,31	0,40	0,49	0,08	0,15	0,22	0,28	0,34
240	0,10	0,18	0,26	0,34	0,42	0,07	0,13	0,18	0,24	0,29
250	0,09	0,17	0,24	0,31	0,38	0,06	0,12	0,17	0,22	0,27
260	0,08	0,15	0,21	0,28	0,34	0,06	0,10	0,15	0,19	0,24
280	0,06	0,12	0,17	0,22	0,27	0,04	0,08	0,12	0,15	0,19
300	0,05	0,08	0,12	0,16	0,19	0,03	0,06	0,08	0,11	0,14

Intermediate values can be interpolated/ Data are limited due to ultimate limit state verifications of the performance given in Annex C4 under consideration of $\gamma_M=2.5$ and $\gamma_F=1.4$

ResiTHERM® 12, ResiTHERM® 16

Performances
Displacement under shear load

Annex C7

Table C8.1: Shear load V values for a single ResiTHERM® 16 for displacements w = 1, 2, 3, 4 or 5 mm, free end not rotatable, under short-term acting load

ResiTHERM® 16 (free end <u>not</u> rotatable; short-term acting load)										
For insulation thickness incl. insulation's plaster and t _{tol} if applicable	Shear load V Temp. 24°C / 40°C					Shear load V Temp. 50°C / 80°C				
	[kN]					[kN]				
	Deviation w					Deviation w				
[mm]	1 mm	2 mm	3 mm	4 mm	5 mm	1 mm	2 mm	3 mm	4 mm	5 mm
60	1,94	2,14	2,14	2,14	2,14	1,94	2,14	2,14	2,14	2,14
80	1,30	2,14	2,14	2,14	2,14	1,30	2,14	2,14	2,14	2,14
100	0,99	1,82	2,14	2,14	2,14	0,99	1,82	2,14	2,14	2,14
120	0,68	1,28	1,84	2,14	2,14	0,68	1,28	1,84	2,14	2,14
140	0,55	1,04	1,49	1,89	2,14	0,55	1,04	1,49	1,89	2,14
160	0,42	0,79	1,15	1,46	1,76	0,42	0,79	1,15	1,46	1,76
180	0,29	0,55	0,80	1,04	1,27	0,29	0,55	0,80	1,04	1,27
200	0,25	0,49	0,71	0,92	1,12	0,25	0,49	0,71	0,92	1,12
220	0,22	0,42	0,61	0,79	0,97	0,22	0,42	0,61	0,79	0,97
240	0,18	0,35	0,51	0,67	0,82	0,18	0,35	0,51	0,67	0,82
250	0,17	0,32	0,47	0,60	0,74	0,17	0,32	0,47	0,60	0,74
260	0,15	0,29	0,42	0,54	0,67	0,15	0,29	0,42	0,54	0,67
280	0,12	0,22	0,32	0,42	0,51	0,12	0,22	0,32	0,42	0,51
300	0,08	0,15	0,22	0,29	0,36	0,08	0,15	0,22	0,29	0,36

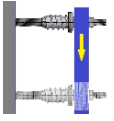

Intermediate values can be interpolated/ Data are limited due to ultimate limit state verifications of the performance given in Annex C4 under consideration of $\gamma_M=2.5$ and $\gamma_F=1.4$

Table C8.2: Shear load V values for a single ResiTHERM® 16 for displacements w = 1, 2, 3, 4 or 5 mm, free end not rotatable, under long-term acting load

ResiTHERM® 16 (free end <u>not</u> rotatable; long-term acting load)										
For insulation thickness incl. insulation's plaster and t _{tol} if applicable	Shear load V Temp. 24°C / 40°C					Shear load V Temp. 50°C / 80°C				
	[kN]					[kN]				
	Deviation w					Deviation w				
[mm]	1 mm	2 mm	3 mm	4 mm	5 mm	1 mm	2 mm	3 mm	4 mm	5 mm
60	1,94	2,14	2,14	2,14	2,14	1,36	1,43	1,43	1,43	1,43
80	1,30	2,14	2,14	2,14	2,14	0,91	1,43	1,43	1,43	1,43
100	0,99	1,82	2,14	2,14	2,14	0,69	1,27	1,43	1,43	1,43
120	0,68	1,28	1,84	2,14	2,14	0,48	0,90	1,29	1,43	1,43
140	0,55	1,04	1,49	1,89	2,14	0,39	0,73	1,04	1,32	1,43
160	0,42	0,79	1,15	1,46	1,76	0,29	0,56	0,80	1,03	1,23
180	0,29	0,55	0,80	1,04	1,27	0,20	0,39	0,56	0,73	0,89
200	0,25	0,49	0,71	0,92	1,12	0,18	0,34	0,50	0,64	0,78
220	0,22	0,42	0,61	0,79	0,97	0,15	0,29	0,43	0,55	0,68
240	0,18	0,35	0,51	0,67	0,82	0,13	0,25	0,36	0,47	0,57
250	0,17	0,32	0,47	0,60	0,74	0,12	0,22	0,33	0,42	0,52
260	0,15	0,29	0,42	0,54	0,67	0,11	0,20	0,29	0,38	0,47
280	0,12	0,22	0,32	0,42	0,51	0,08	0,15	0,22	0,29	0,36
300	0,08	0,15	0,22	0,29	0,36	0,06	0,11	0,16	0,20	0,25

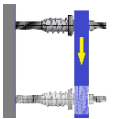

Intermediate values can be interpolated/ Data are limited due to ultimate limit state verifications of the performance given in Annex C4 under consideration of $\gamma_M=2.5$ and $\gamma_F=1.4$

ResiTHERM® 12, ResiTHERM® 16

Performances
Displacement under shear load

Annex C8

Table C9.1: Displacements of the fixing system under tension load, temp. range 24°C/ 40°C

Fixing system	Tension load	Displacement	Displacement
	N	δ_{NO}	$\delta_{N\infty}$
	[kN]	[mm]	[mm]
ResiTHERM® 12 (M12 anchor rod)	5,14	0,47	0,94
ResiTHERM® 16 (M16 anchor rod)	4,57	0,32	0,64

The displacement in the base material must be added

Table C9.2: Displacements of the fixing system under pressure load, temp. range 24°C/40°C

Fixing system	Pressure load	Displacement	Displacement
	P	δ_{PO}	$\delta_{P\infty}$
	[kN]	[mm]	[mm]
ResiTHERM® 12 (M12 anchor rod)	5,14	0,31	0,62
ResiTHERM® 16 (M16 anchor rod)	5,14	0,31	0,62

The displacement in the base material must be added

Table C9.3: Displacements of the fixing system under tension load, temp. range 50°C/ 80°C

Fixing system	Tension load	Displacement	Displacement
	N	δ_{NO}	$\delta_{N\infty}$
	[kN]	[mm]	[mm]
ResiTHERM® 12 (M12 anchor rod)	5,14	0,47	0,94
ResiTHERM® 16 (M16 anchor rod)	4,57	0,32	0,64

The displacement in the base material must be added

Table C9.4: Displacements of the fixing system under pressure load, temp. range 50°C/ 80°C

Fixing system	Pressure load	Displacement	Displacement
	P	δ_{PO}	$\delta_{P\infty}$
	[kN]	[mm]	[mm]
ResiTHERM® 12 (M12 anchor rod)	5,14	0,31	0,62
ResiTHERM® 16 (M16 anchor rod)	5,14	0,31	0,62

The displacement in the base material must be added

ResiTHERM® 12, ResiTHERM® 16

Performances

Displacement under tension and pressure load

Annex C9

Point thermal transmittance

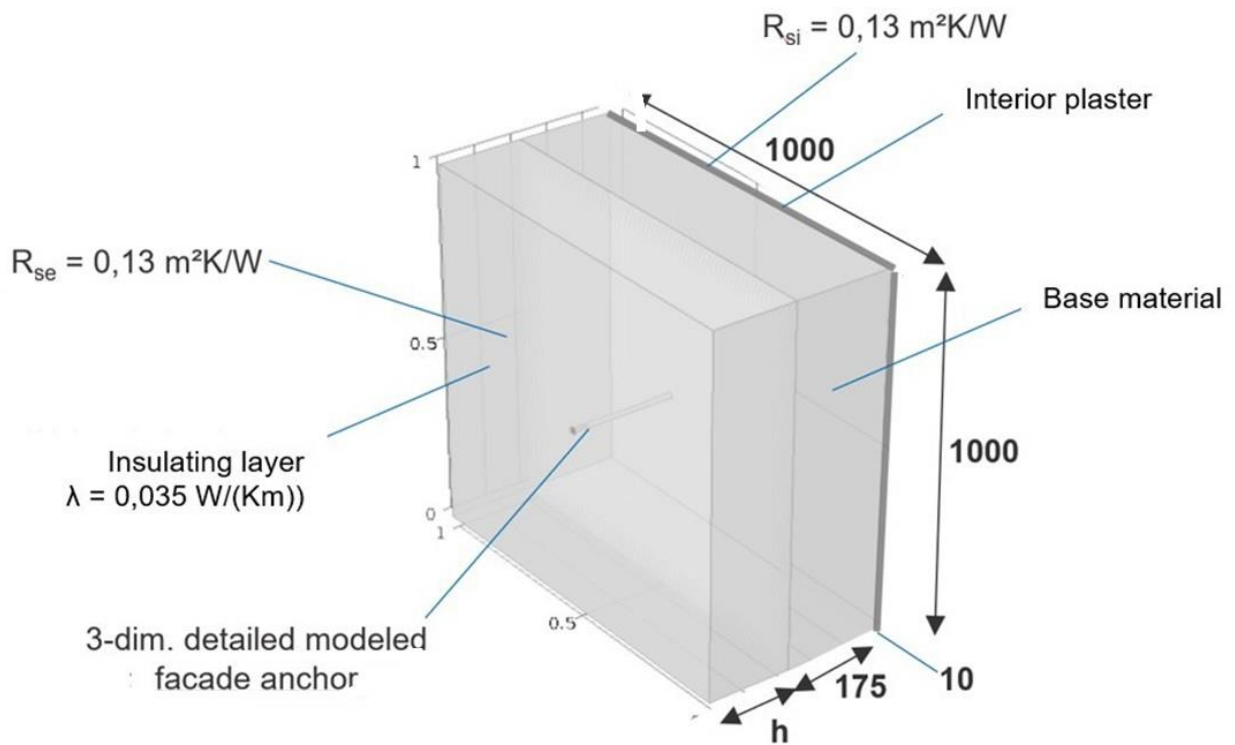

Table C10.1: Thermal conductivity values used for the determination of equivalent thermal conductivity

Base material group	Description	Value of thermal conductivity λ
		[W/(m·K)]
Plaster	Gypsum plaster without aggregate	0,57
Base material	Normal weight concrete	2,30
Insulation	Insulation material	0,035
Anchor rod	Carbon steel anchor rod	50
Anchor	Stainless steel anchor rod	17
Separation module	Thermal separation module PA6 GF	0,335

ResiTHERM® 12, ResiTHERM® 16

Performance
Equivalent thermal conductivity values and point thermal transmittances

Annex C10

Table C11.1: The equivalent thermal conductivity λ_{eq}

		8.8 anchor rod				A4 anchor rod			
thickness of insulation h_D	[mm]	60	150	220	300	60	150	220	300
equivalent thermal conductivity λ_{eq}		$\lambda_{eq 60}$	$\lambda_{eq 150}$	$\lambda_{eq 220}$	$\lambda_{eq 300}$	$\lambda_{eq 60}$	$\lambda_{eq 150}$	$\lambda_{eq 220}$	$\lambda_{eq 300}$
ResiTHERM® 12	[W/mK]	1,1*	8,5*	15,1*	-	0,9*	7,2	9,2*	-
ResiTHERM® 16	[W/mK]	1,1	8,5	15,1	22,6	0,9	7,5	9,2	11,2

* derived from the calculation with ResiTHERM 16

Table C11.2: Point thermal transmittances for thermal conductivity χ

		8.8 anchor rod				A4 anchor rod			
thickness of insulation h_D	[mm]	60	150	220	300	60	150	220	300
point thermal transmittance χ		χ_{60}	χ_{150}	χ_{220}	χ_{300}	χ_{60}	χ_{150}	χ_{220}	χ_{300}
ResiTHERM® 12	[W/K]	0,0026*	0,0045	0,0056*	-	0,0025*	0,0033	0,0040*	-
ResiTHERM® 16	[W/K]	0,0026	0,0049	0,0056	0,0064	0,0025	0,0040	0,0040	0,0041

* derived from the calculation with ResiTHERM 16

ResiTHERM® 12, ResiTHERM® 16

Performance
Equivalent thermal conductivity values and point thermal transmittances

Annex C11