



DESIGN PERFORMANCE RELIABILITY

AGILITY

User Manual



DISTRIBUTED BY



www.wholesalemobility.com.au

Contents

BEFORE DRIVING	1
1. INSTRUCTIONS FOR USE	1
2. INTRODUCTION	2
3. GENERAL SAFETY INFORMATION	3
4. GETTING TO KNOW YOUR SCOOTER	15
5. PRODUCT SPECIFICATIONS	18
6. PUSHING AND TRANSPORTING THE SCOOTER 19	
7. ADJUSTING THE SCOOTER	20
7.1 <i>SWIVELING THE SEAT TO GET ON AND OFF</i>	<i>20</i>
7.2 <i>SWIVELING THE SEAT TO GET ON AND OFF</i>	<i>20</i>
7.3 <i>ADJUSTING THE BACKREST ANGLE</i>	<i>21</i>
7.4 <i>ADJUSTING THE HEADREST HEIGHT</i>	<i>21</i>
7.5 <i>ADJUSTING THE TILLER ANGLE</i>	<i>22</i>
7.6 <i>ADJUSTING THE SEAT BELT FOR LENGTH AND</i> <i>FITTING</i>	<i>22</i>
7.7 <i>TURNING THE SEAT</i>	<i>23</i>
OPERATING	24
8. OPERATING THE SCOOTER	24
8.1 <i>POWERING ON/OFF</i>	<i>25</i>
8.2 <i>LCD PANEL</i>	<i>25</i>
8.3 <i>ADJUSTING THE SPEED</i>	<i>26</i>
8.4 <i>DRIVING FORWARDS AND BACKWARDS</i>	<i>27</i>
8.5 <i>USING THE BRAKES</i>	<i>28</i>
8.6 <i>OVERLOAD PROTECTION</i>	<i>28</i>
8.7 <i>SWITCHING ON THE HEADLIGHTS</i>	<i>29</i>
8.8 <i>SWITCHING ON THE HORN</i>	<i>29</i>
8.9 <i>SWITCHING ON THE HAZARD Lights</i>	<i>29</i>
8.10 <i>SWITCHING ON THE TURN SIGNAL</i>	<i>29</i>
8.11 <i>SWITCHING ON THE TEMP</i>	<i>30</i>

Contents

8.12	SWITCHING ON THE ADJ	30
8.13	SWITCHING ON THE MOD.....	30
8.14	SWITCHING ON THE TIME.....	30
8.15	POWERING OFF/PARKING THE SCOOTER.....	30
8.16	12V POWER SOCKET	32
9.	BATTERY AND CHARGING THE BATTERY	33
9.1	BATTERY STATUS DISPLAY	34
9.2	CHARGING THE BATTERIES.....	35
9.3	AFTER CHARGING	38
9.4	ERROR CODE.....	38

BEFORE DRIVING

1. INSTRUCTIONS FOR USE

The scooter is a motorised electric scooter for use outdoors primarily on flat surfaces such as pavements, roads, parking lots and drive ways.

It is intended to increase the mobility of people who are both physically and mentally capable of correctly assessing driving situations and reacting correspondingly to them at any time.



Uses:

DO NOT operate this equipment without first reading and understanding the user manual. If you are unable to understand the warnings, cautions, and instructions, please contact your dealer; otherwise injury or damage may result. Procedures other than those described in this manual **MUST** be performed by a qualified technician.

We reserve the right to make changes and update this manual without further notice.

**Copyright © 2013 Kymco HealthCare Inc.
This scooter meets all of the requirements of ISO
7176-9:2009**

2. INTRODUCTION**DEAR CUSTOMER**

With your scooter, you have now purchased a product which has been manufactured in accordance with the latest technical capabilities and based on the highest levels of user comfort.

We have placed great focus on the simplest possible operation and long service life in both construction and material selection.

This Operating Manual assumes that the suitability of the user for scooter usage has been discussed with a doctor, therapist and/or dealer before operation.

The operating manual will help you get to know the function of your scooter and, in addition, describes

- operation
- care and maintenance
- repair

This manual has been drawn up using information available at the time of printing with regard to construction and operation of the scooter.

We reserve the right to make changes due to technical improvements.

If you have any other questions about this scooter please contact your retailer or supplier.

GENERAL SAFETY INFORMATION

3. GENERAL SAFETY INFORMATION

 **WARNING!** Before you operate your scooter, please read and understand all of the information provided with your scooter for your safety. As operating any vehicle, only drive with full alertness to ensure safety.

 **WARNING!** Please observe the warnings below to avoid any damage or injury resulting from improper use of your scooter. The scooter user is responsible for taking proper safety measures. We will not be held liable for personal injury and/ or product damage resulting from improper use of the scooter. Obey all local pedestrian traffic rules. It may be difficult for others to see you when you are seated on your scooter. Wait until your path is clear of traffic, and then proceed with extreme caution. Use of safety equipment such as reflectors/reflective clothing, lights, and safety flags is advisory.

 **WARNING!** Please consult your healthcare professionals routinely to ensure there are no health or physical conditions that may limit or impair your ability to safely operate your scooter.

 **WARNING!** Consult your physician if you are taking prescription or over-the-counter medications or if you have any physical limitations. Some medications and physical limitations may impair your ability to safely operate your scooter.

 **WARNING!** Do not operate your scooter while you are under the influence of alcohol, as this may impair your ability to safely operate your scooter.

 **WARNING!** Every scooter is different. Take time to learn the feel of this scooter before driving.

 **WARNING!** BE AWARE that becoming a capable, safe scooter operator will take time and practice.

GENERAL SAFETY INFORMATION

 **WARNING!** Anti-tippers substantially reduce your risk of tipping over backwards, which can cause serious injury.

 **WARNING!** Have someone help you practice bending and reaching on the scooter and transferring to and from the scooter until you learn how to do it safely.

 **WARNING!** NEVER try a new manoeuvre on your own.

 **WARNING!** Get to know the areas where you plan to use your scooter. Look for hazards and learn how to avoid them.

 **WARNING!** Do not use the scooter other than for its original purpose. Avoid any use, such as weight training, sports, athletics, hauling, moving or towing anything, that may lead to safety hazards and undue stress on the scooter.

 **WARNING!** Your scooter is designed for one passenger only. Do not carry passengers on your scooter.

 **WARNING!** We strongly recommend that you do not smoke cigarettes while seated on your scooter. You must adhere to the following safety guidelines if you decide to smoke cigarettes while seated in your scooter: Do not leave lit cigarettes unattended. Keep ashtrays at a safe distance from the seat cushions. Always make sure cigarettes are completely extinguished before disposal.

 **WARNING!** Do not modify your scooter in any way by yourself. For any accessories, please contact your approved service provider for installation by an authorized service technician.

GENERAL SAFETY INFORMATION

 **WARNING!** The addition of accessories to your scooter may change certain specifications such as overall weight, size, and /or the center of gravity of your scooter. Please note how some of the changes may damage any objects around you.

 **WARNING!** Do not change your seating configuration. Please contact your approved service provider for any adjustments.

 **WARNING!** Do not use any replacement on your scooter, such as a different seating system. Only use the seating system that has been tested for safety and provided by the manufacturer.

 **WARNING!** Do not remove the seat cushion provided with the scooter. Do not place any cushion, padding, or pillow on the seat. This could create an unstable seat position, resulting in a fall from the scooter.

 **WARNING!** Exercise extreme caution when using oxygen in close proximity to electrical circuits and combustible materials. Contact your oxygen provider for information on using oxygen safely.

 **WARNING!** Do not change the settings of the controller. Please call your approved service provider to check the controller settings on your scooter every six to twelve months. Please contact your approved service provider if you notice any change in your ability to control your scooter.

 **WARNING!** Do not use your scooter in "freewheel" mode without an attendant present.

 **WARNING!** Do not place the scooter in "freewheel" mode while the unit is powered up. Always power off the scooter and remove the key from the key switch before engaging or disengaging "freewheel" mode.

 **WARNING!** To prevent the scooter from rolling uncontrollably on its own, never place the scooter

GENERAL SAFETY INFORMATION

in "freewheel" mode on any incline or decline.

 **WARNING!** If you anticipate being seated in a stationary position for an extended period of time, turn off the power to the scooter. This will prevent unexpected or unintended scooter movement.

 **WARNING!** Avoid using any accessories that may interfere with the operation of the throttle control lever, which may result in unintended or uncontrolled movement of the scooter.

 **WARNING!** Keep yourself, clothing, and all other objects away from the tires while driving. Do not allow any objects to drag behind the scooter when driving. Loose-fitting clothing or other objects can get caught in the tires and /or the running gear.

 **WARNING!** Possible strangulation hazard! Be aware that clothing, lanyards, necklaces, other jewellery, purses, and other accessories worn or carried by you while you are seated on or operating the scooter may get caught around the armrests or throttle control lever.

 **WARNING!** Do not connect any device to the scooter electrical system or use the scooter batteries to power anything else other than your scooter.

 **WARNING!** Always grasp the connector itself when disconnecting any wires. Do not pull on electrical harnesses directly.

 **WARNING!** Keep all charger power cord connectors clean, dry and away from sources of dampness at all times to prevent damage to the electrical system and /or personal injury. Check any actuators for loose, worn, or damaged items and have any damaged wires replaced immediately.

 **WARNING!** Check electrical components frequently for signs of corrosion and have them replaced as necessary.

GENERAL SAFETY INFORMATION

 **WARNING!** Always secure the scooter and its batteries when it is being transported. Batteries should be secured in an upright position and protective caps should be secured on the battery terminals. Do not transport the scooter and /or batteries with any flammable or combustible items.

 **WARNING!** Do not handle batteries without supervision by an authorized service technician. Battery posts, terminals, and related accessories contain lead and lead compounds and can be hazardous. Scooter batteries are heavy. Anyone lifting scooter batteries should use proper lifting techniques and avoid lifting beyond his/her capacity.

 **WARNING!** NEVER attempt to recharge the batteries by attaching cables directly to the battery terminals or clamps.

 **WARNING!** DO NOT attempt to recharge the batteries and operate the scooter at the same time.

 **WARNING!** Always use two batteries of the exact same type, chemistry, and amp-hour (Ah) capacity. Follow the specifications provided in the user manual for battery type and capacities.

 **WARNING!** Do not mix old and new batteries. Always replace both batteries at the same time.

 **WARNING!** Only sealed batteries that meet DOT CFR173.159 should be used in the scooter. Replacement batteries should be obtained directly from an authorized provider to ensure conformity, fit, and function.

 **WARNING!** Always protect the batteries from freezing; for those living in cold climates, make sure you store the scooter properly. Never charge a frozen battery. Charging a frozen battery may result in damage to the battery and could be dangerous.

 **WARNING!** Do not remove any fuse links (if fitted) from the battery harnesses. If the fuse links

GENERAL SAFETY INFORMATION

appear damaged, contact your authorized provider.



WARNING! Do not operate the scooter with depleted batteries; you could be stranded.



WARNING! Reduce your speed, do not make any sharp turns and maintain a stable center of gravity while turning /cornering. To prevent tipping, avoid shifting your weight in the opposite direction of a turn.



WARNING! While driving up inclines or low curbs, drive your scooter straight on with the wheels perpendicular to the incline and/or low curb; both front wheels should contact the incline/low curb at the same time. To reduce the possibility of a fall, do not drive at an angle; do not get one wheel or side of the scooter on the incline/low curb first. Always exercise extreme caution when negotiating an incline.



WARNING! Do not travel up or down potentially hazardous surfaces and/or inclines, including but not limited to areas covered with snow, ice, cut grass, or wet leaves.



WARNING! When climbing an incline, try to keep the scooter moving. If stopping is necessary, start up again slowly and then accelerate with caution.



WARNING! When descending an incline, use the slowest speed possible. If the descent is faster than you desire, release the throttle control lever to stop the scooter. Then press the throttle control lever slightly to control the speed of your descent.



WARNING! The maximum recommended incline angles (see specifications) are tested in a controlled environment. Your scooter's ability to climb up inclines is affected by your weight, speed and the angle you approach the incline among other factors.





WARNING! Only drive backwards on a flat surface. When driving backwards, operate your scooter at a lower and even speed. Stop often and

GENERAL SAFETY INFORMATION

check to make sure your path is clear of obstacles. To prevent tipping, do not travel down an incline or ramp backwards.

 **WARNING!** To avoid overloading the scooters and potential tipping, never carry anything or fill the basket with contents weighing more than 15lbs (6.8kg).

 **WARNING!** Avoid any change of position or movement that may change your center of gravity while sitting on the scooter. This may cause your scooter to tip.

 **WARNING!** A drop-off (as small as 2 inches) at the bottom of a slope can stop a front wheel and cause the scooter to tip forward.

 **WARNING!** Never reach or lean if you must shift your weight sideways or rise up off the seat.

 **WARNING!** Never reach or lean if you must move forward in your seat to do so. Always keep your buttocks in contact with the backrest.

 **WARNING!** Never try to pick up an object from the floor by reaching down between your knees.

 **WARNING!** Never reach or lean over the top of the seat back. This may damage the backrest and cause you to fall.

 **WARNING!** Do not use the armrests for any weight bearing purposes. Such use may cause the scooter to tip, which may result in a fall from the scooter and personal injury.

 **WARNING!** Do not put all of your weight on one side of the scooter deck. Such use may cause the scooter to tip.

 **WARNING!** Even though your scooter may be capable of handling greater obstacles, we recommend that you do not attempt to negotiate a curb that has a height greater than 2" (5cm). Doing so could cause instability in your scooter. Riding over curbs or

GENERAL SAFETY INFORMATION

obstacles can cause tipping and serious bodily harm. If you have any doubt that you can safely cross any curb or obstacle, **ALWAYS ASK FOR HELP**. Be aware of your riding skills and personal limitations. You may need to remove or cover threshold strips between rooms and install a ramp at entry or exit doors.



WARNING! Do not try to climb an obstacle when on an incline.



WARNING! Do not drive over an obstacle with just one wheel.



WARNING! Do not drive on uneven terrain and/or soft surfaces.



WARNING! Do not drive near tall grass that can entangle the running gear.



WARNING! Avoid driving on loosely packed gravel and/or sandy surfaces.



WARNING! Do not use your scooter on or near railroad tracks or crossings.



WARNING! Do not ride your scooter along the edges of streams, lakes, or the ocean. Never use your scooter to cross waterways.



WARNING! If you feel unsure about a driving surface, avoid that surface.



WARNING! Do not expose your scooter to open flames.





WARNING! Keep your scooter in a dry and clean condition. Never take your scooter into a shower, tub, pool, or sauna. Rain, snow, salt, mist/spray conditions, and icy/slippery surfaces can damage the scooter components or cause the scooter frame to prematurely rust.





WARNING! Avoid prolonged exposure to heat or cold; it may affect the temperature of upholstered and non-upholstered components on the scooter. Exercise caution when using your scooter in extremely hot or cold conditions.

GENERAL SAFETY INFORMATION

 **WARNING!** Do not tow your scooter. Towing may exceed the maximum speed threshold, resulting in damage to critical components of the scooter.

 **WARNING!** Use extreme caution when it is necessary to move an unoccupied scooter up or down stairs. Remove the seat, batteries, and any accessories before attempting the transfer. Use proper lifting techniques and use only solid, non-removable frame components to lift the scooter with multiple physically capable attendants. Do not lift or move your scooter or seating system by grasping or holding onto any of its removable parts, including the armrest(s), seat cushions, seatback, or shrouds.

 **WARNING!** When your scooter is used with any type of lift/elevation devices, always turn off the power of the scooter; make sure the scooter is not in "freewheel" mode and do NOT sit on your scooter. Failure to follow this may result in unintended movement and personal injury or product damage.

 **WARNING!** Never use your scooter to negotiate stairs or escalators.

 **WARNING!** Never sit on the scooter while it is in a moving vehicle.

 **WARNING!** It is dangerous to transfer to and from your scooter on your own. It requires good balance and agility. Be aware that there is a point during every transfer when the seat is not below you.

 **WARNING!** To make a safe transfer: Always turn off the power before you transfer to or from your scooter. If you fail to do so you may touch the throttle control lever and cause your scooter to move when you do not expect it. Make sure motor locks are engaged; this keeps the scooter from moving when you transfer. Work with your health care professional to learn how to position your body and how to support yourself during a

GENERAL SAFETY INFORMATION

transfer. Have someone help you until you are sure you

GENERAL SAFETY INFORMATION

do a safe transfer on your own. Move your scooter as close as you can to the seat you are transferring to. Transfer as far back onto the seat surface as you can. This will reduce the risk that you will miss the seat or fall.



WARNING! Never transport the scooter in the front seat of a vehicle. It may shift and interfere with the driver.



WARNING! Always secure the scooter so that it cannot roll or shift.



WARNING! Should the fittings on your seating system become loose, please call your approved service provider.

WARNING! Replace worn or damaged upholstery immediately to reduce the risk of fire hazard.



WARNING! Be aware that washing of upholstered items may reduce the fabric's resistance to flammability.



WARNING! Radio wave sources, such as radio stations, TV stations, amateur radio (HAM) transmitters, two-way radios, and cellular phones, can affect motorised scooter control. Following the warnings listed below should reduce the chance of unintended brake release or motorised scooter movement, which could result in serious injury.

- 1) Do not turn ON hand-held personal communication devices, such as citizens band (CB) radios and cellular phones, while the motorised scooter is turned ON;
- 2) Be aware of nearby transmitters, such as radio or TV stations, and try to avoid coming close to them;
- 3) If unintended movement or brake release occurs, turn the motorised scooter OFF as soon as it is safe;
- 4) Be aware that adding accessories or components, or modifying the motorised scooter, may make it

GENERAL SAFETY INFORMATION

more susceptible to interference from radio wave sources (Note: There is no easy way to evaluate their effect on the overall immunity of the motorised scooter); and

- 5) Report all incidents of unintended movement or brake release to the motorised scooter manufacturer, and note whether there is a radio wave source nearby.

Important Information

- 1) 20 volts per meter (V/m) is a generally achievable and useful immunity level against interference from radio wave sources (as of May 1994)(the higher the level, the greater the protection);
- 2) This product has an immunity level of 20 volts per meter (V/m)

GETTING TO KNOW YOUR SCOOTER

4. GETTING TO KNOW YOUR SCOOTER

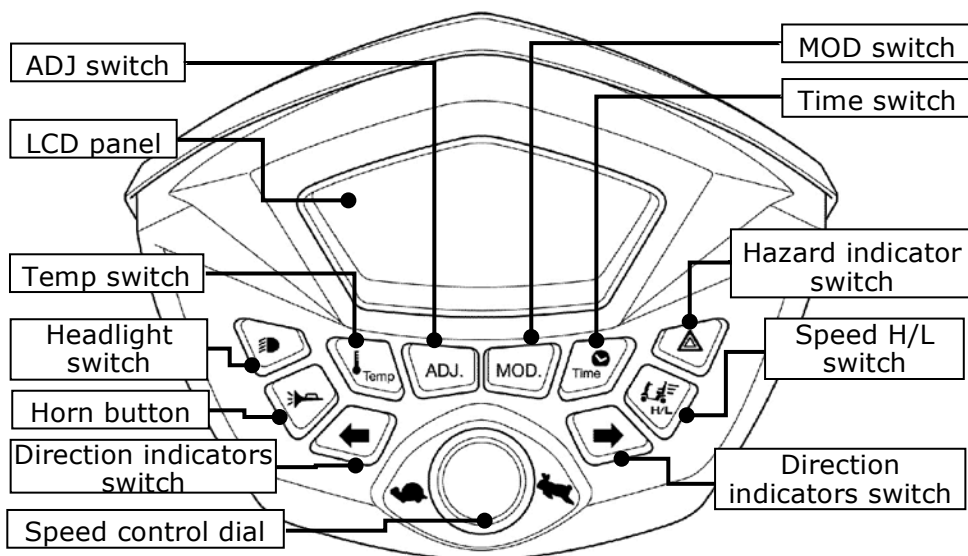
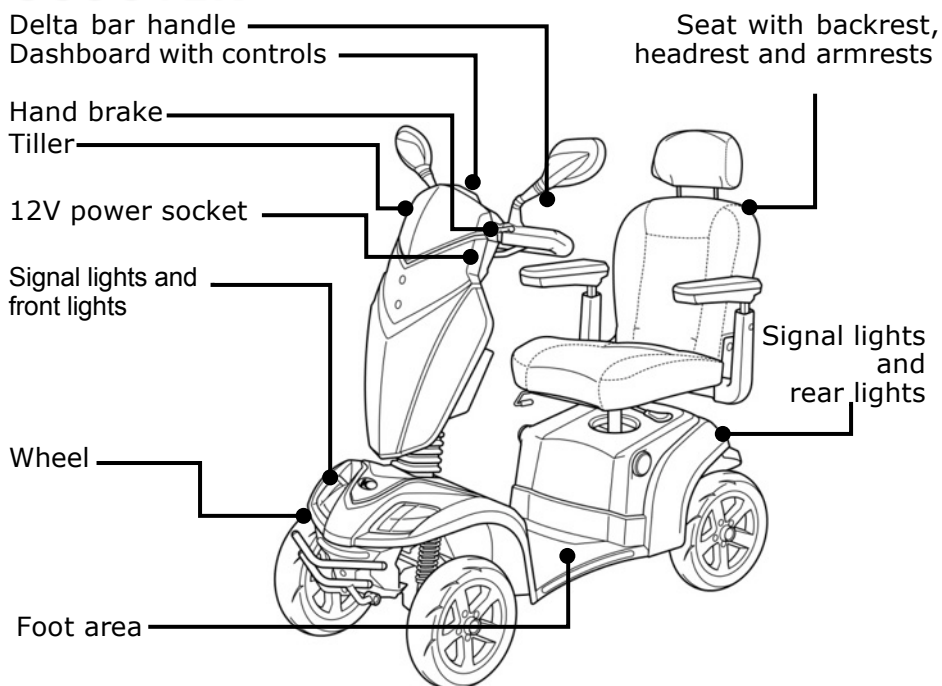

GETTING TO KNOW YOUR SCOOTER

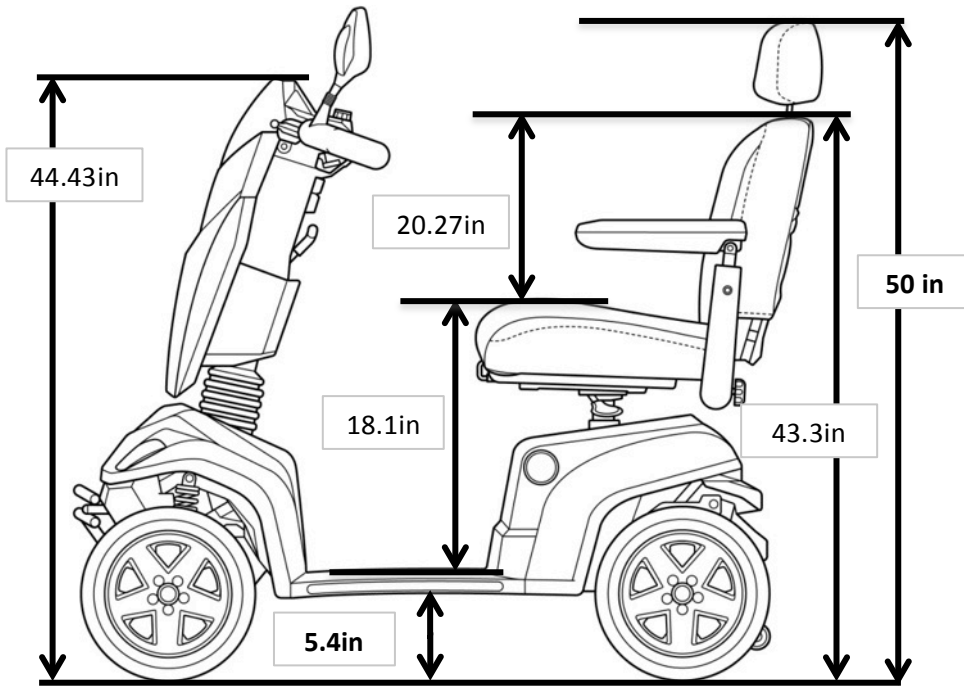
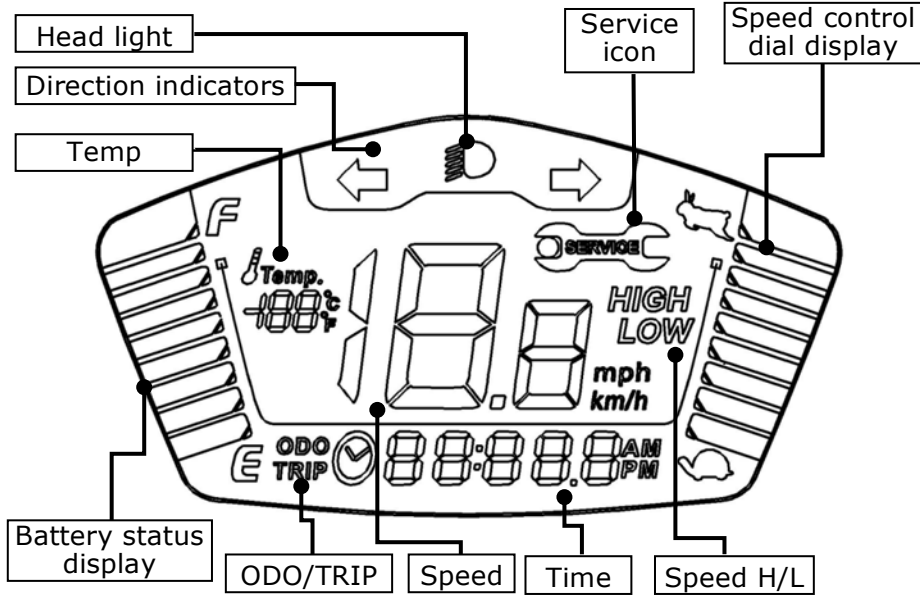

GETTING TO KNOW YOUR SCOOTER

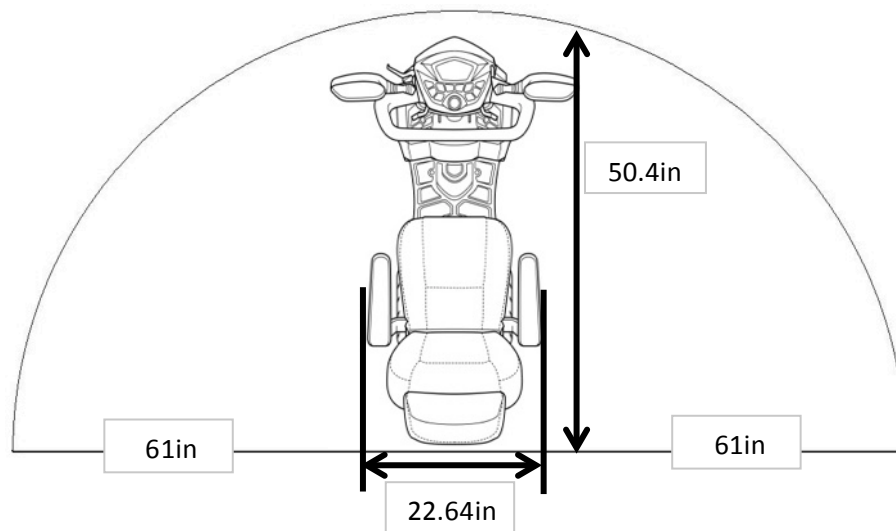

PRODUCT SPECIFICATIONS

5. PRODUCT SPECIFICATIONS

Model Name	EQ35FA(UK)
Maximum weight capacity	363 lbs (165kg) 26 stone
Overall height	43.3 in (1100 mm)
Overall length	50.4 in (1280 mm)
Overall width	22.6 in (575 mm)
Drive System	Direct drive rear wheels (with differential gear)
Battery	12 V × 50 Ah × 2 Pcs
Battery charger	Off-board
	Input voltage: 100-240VAC,
	Output voltage: 24VDC
	Output current: 5A
Front wheel	Pneumatic, 12 in*2
Rear wheel	Pneumatic, 12 in*2
Rear wheel drive system	Transaxle
Braking system	Motor electromagnetic brake+ manual auxiliary brake
Maximum incline angle	12 degree
Per-charge Run distance	Up to 24.8 miles (40km)
Maximum speed	
Forward	8mph (12.8 kph)
Backward	2.78mph (4.5 kph)
Turning radius	61.4 in (1560 mm)
Overall height of seat	18.1 in (460 mm)
Overall width of seat	16.0 in (406 mm)
Overall depth of seat	16.5 in (420 mm)
Overall weight of seat	11.4 lbs. (5.2 kg)

6. PUSHING AND TRANSPORTING THE SCOOTER

1. Please carefully read the safety information in section 3 related to transportation first.

2. Pushing the scooter:

In order to push the scooter, you must place the scooter in “**freewheel**” mode, which disengages the drive motor. The release lever is located at the bottom right-hand side of the scooter under the seat.



WARNING!

When the lever is pushed up in freewheel mode:

- The scooter must be on a flat surface and stationary.
- Do not sit on the scooter.

To push the scooter:



=Freewheel

Mode: (Motor is disengaged.)

1. Power off the scooter and remove the key.
2. Pull the lever upwards as far as the stop (see diagram).
3. Push the scooter to your desired location.
4. Push the lever downwards as far as the stop (see diagram).



=Driving Mode:(Motor is engaged.)



1. Always switch the scooter off to push it.
2. Do not push the scooter too fast. If a pre-set speed is exceeded while you are pushing the scooter, the drive motor will switch on automatically and brake the scooter.

ADJUSTING THE SCOOTER

 After **any** adjustments, repair or service and **before** use, make sure all hardware is tightened securely - otherwise injury or damage may result.

7. ADJUSTING THE SCOOTER

The following describes how to set up and adjust your Scooter in order to have a comfortable and safe drive.

7.1 SWIVELING THE SEAT TO GET ON AND OFF

1. Lift the seat lever and rotate the seat to the side (left or right) to get on.
2. Sit on the seat and turn the seat back to the direction of travel. Lock the seat in place by releasing the seat lever.

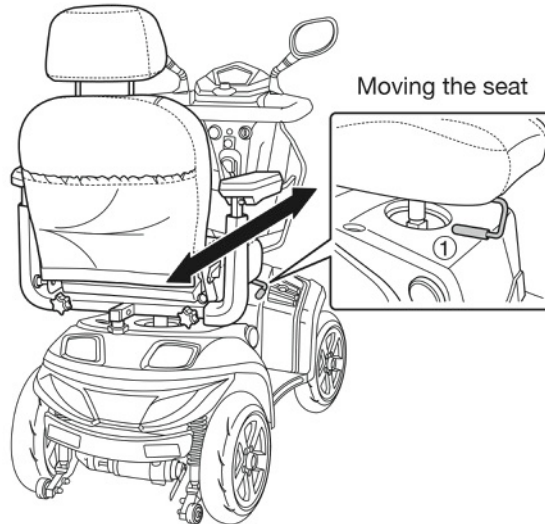

Accident hazard due to an improperly locked seat:

Ensure that the seat is properly locked after adjustment; if the seat is properly locked, it will not move when you try pushing the seat slightly forwards and backwards.

7.2 SWIVELING THE SEAT TO GET ON AND OFF

1. Lift the seat lever and rotate the seat to the side (left or right) to get on.

ADJUSTING THE SCOOTER

2. Sit on the seat and turn the seat back to the direction of travel. Lock the seat in place by releasing the seat lever. Fasten your seat belt.

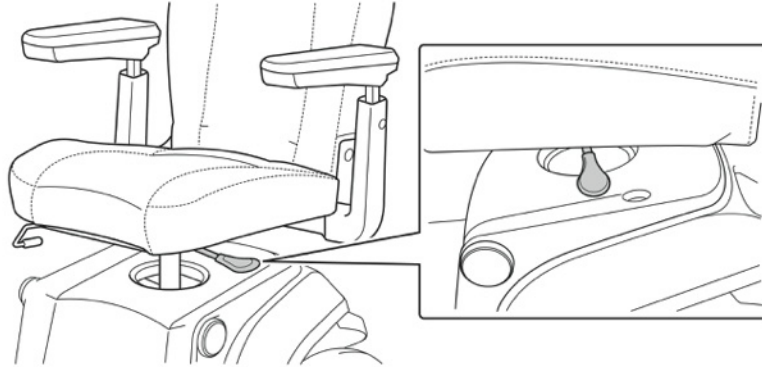

 *Ensure that the seat is properly engaged after adjustment by seeing that the seat doesn't move when you try rotating it to either side.*

7.3 ADJUSTING THE BACKREST ANGLE

The backrest angle can be adjusted to three locking stages.

1. Pull the locking lever out and move the backrest forwards or backwards to the desired position.
2. Let go of the locking lever and engage the locking mechanism by pushing the backrest slightly forwards and backwards.

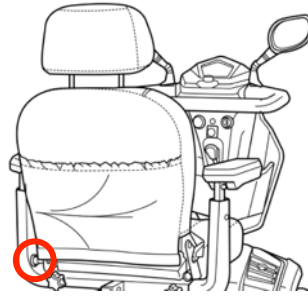

 **Accident hazard if backrest is not properly locked!**

Ensure that the backrest is properly locked after adjustment by seeing that it doesn't move when you try pushing it slightly forwards and backwards.

7.4 ADJUSTING THE HEADREST HEIGHT

Raising the headrest:

Pull the headrest upwards into the desired position until

ADJUSTING THE SCOOTER

the lowering protection locking mechanism engages audibly.

Lowering the headrest:

Press the locking lever in and push the headrest down to the desired position.

Release the locking lever, and engage the lowering protection by moving the headrest slightly.

7.5 ADJUSTING THE TILLER ANGLE

Always adjust the tiller so that you can reach the dashboard and control your scooter easily at any time.

1. Pull the locking lever (1).

2. Push the tiller forwards or backwards to the desired position(2).

3. Release the locking lever knob.

4. Ensure that the tiller is engaged correctly by trying to move it backwards and forwards.

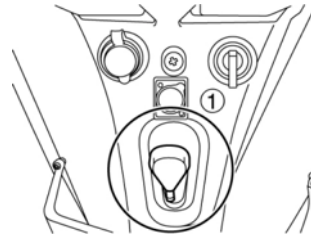

Push the locking lever –to lock

Pull the locking lever –to unlock

Accident hazard due to non-engaged tiller:

Ensure that the tiller is properly locked after adjustment by seeing that it doesn't move when you try pushing it slightly forwards and backwards.

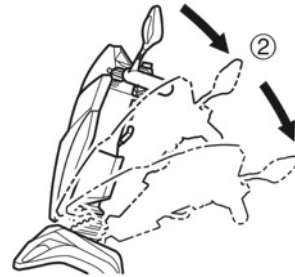

7.6 ADJUSTING THE SEAT BELT FOR LENGTH AND FITTING

Adjusting for length:

Release the belt buckle clasp. Adjust the seat belt length by pulling on the loose end of the strap.

Closing the seat belt:

Press the seat belt tab into the clasp until it audibly

ADJUSTING THE SCOOTER

locks in place.

7.7 TURNING THE SEAT

The seat can be turned to both sides, and firmly engaged in 8 positions (at 45° intervals).

Pull the turning lock (1), turn the seat in the required

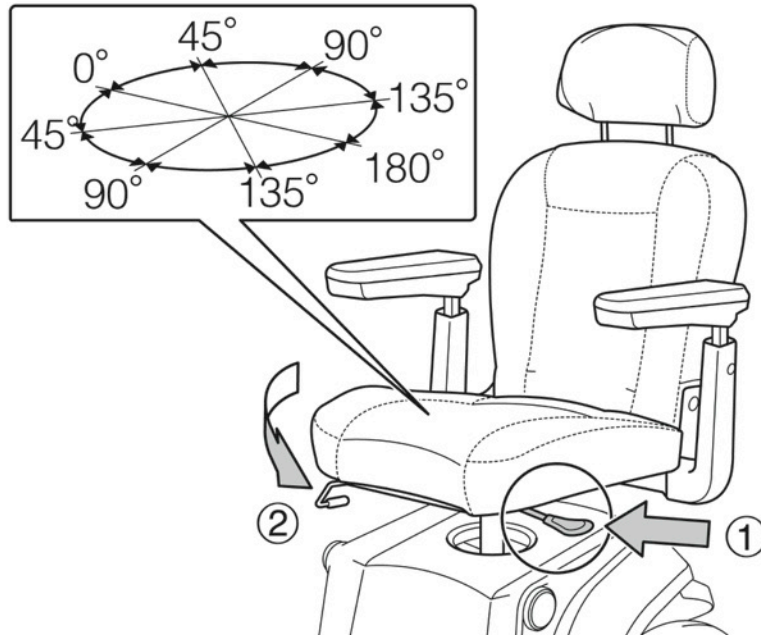

direction or position (2) and engage.



Accident hazard due to incorrect seat position:

Always turn the seat to face forward and lock it before driving.

If the seat has been turned, the possibility of tipping is increased.

Before turning the seat, always ensure that the scooter is on an even and solid surface.



OPERATING

8. OPERATING THE SCOOTER

Always carry out the safety information described in the "General Safety Information" section:

Before starting to drive, adjust the seat and tiller to a comfortable position.



WARNING! *Every scooter is different. Take the time to learn the feel of your scooter before you begin riding.*



WARNING! *BE AWARE* that becoming a capable and safe scooter operator will take time and practice.



WARNING! *Anti-tippers substantially reduce your risk of tipping over backwards, which can cause serious injury.*

Please observe the following tips for a safe journey:

1. Always match your speed to the driving situation in which you find yourself.
2. Always reduce your speed when you are driving through:
 - Unclear areas
 - narrow gaps
 - Tight curves
 - inclines
 - Ramps
3. Take a trial run with the scooter in an area with no pedestrians, or in a closed-off area.
4. Always steer the scooter with both hands on the handlebars.
5. Always keep your feet within the foot area while driving the scooter

OPERATING THE SCOOTER

6. Check before you power on the scooter:

Ensure your scooter is in drive mode (not in "freewheel" mode)	Check the "freewheel" mode lever is in the pushed down position
Seat is locked into the desirable position	Move the seat forwards and backwards to ensure it is stationary.
Are the batteries charged?	Check the dashboard to verify the charging status of the batteries
Are the brakes working?	Check by driving slowly and stopping again
Are the tires and wheels undamaged and is the air pressure correct?	Visual check of tires and wheels

8.1 POWERING ON/OFF

The switch is located near the right side of the dashboard.

Insert the key into the switch and turn it to the right to power on the scooter.

Turn it to the left to power off the scooter.

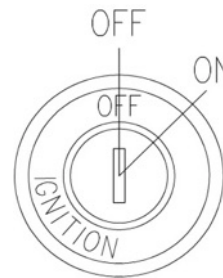

8.2 LCD PANEL

LCD panel "On":

The scooter is switched on and ready for driving.

If the Operation indicator is blinking:

There may be a faulty situation. Please switch off the scooter and contact your approved service provider.

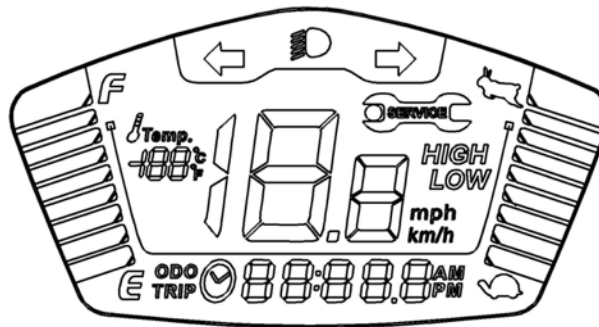

OPERATING THE SCOOTER

8.3 ADJUSTING THE SPEED



Use the two speed adjustment mechanisms to adjust the speed to suit your driving conditions.

Always use lower speed if you are uncertain about the driving conditions.

There are two mechanisms to control the speed of your scooter.





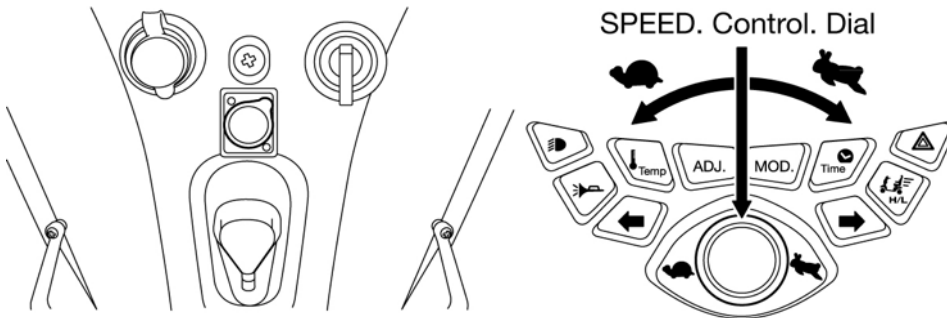

1. High/Low Speed Switch:
 - a. It is located on the meter.
 - b. It is designed to preselect the maximum speed levels.
 - c. If the toggle switch is set at "High" level, the maximum speed allowed is 8 mph (12.8 kph)
 - d. If the toggle switch is set at "Low" level, the maximum speed allowed is 4 mph (6.4 kph)
2. Speed Control Dial:
 - a. It is located in the centre of the dashboard.
 - b. It is designed to further adjust your speed after you preselect the maximum speed by using the High/Low Speed Toggle Switch.



Anticipated Speed levels:

- c. The speed levels are tested under controlled environments and your driving speed may vary depending on the driving conditions and loads.

OPERATING THE SCOOTER

EQ35FA(UK)	
1. High/Low Speed Toggle: to preselect the maximum speed	2. Speed Control Dial: to further adjust the speed level
Driving Forwards	Turtle   Rabbit
High	3.5 mph to 8 mph
Low	2.2 mph to 4 mph
Driving Backwards	Turtle   Rabbit
High	2.4mph to 2.8 mph
Low	2 mph to 2 mph

8.4 DRIVING FORWARDS AND BACKWARDS

Hold the tiller handles firmly with both hands. Use your right index and middle fingers to pull the right side of the lever to move forward.

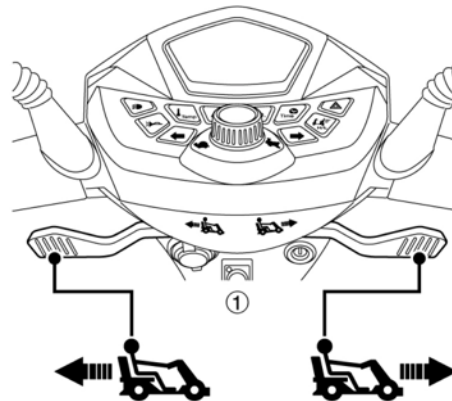

 = driving forwards
Release the lever and allow the scooter to come to a complete stop.

Use your left index and middle fingers to pull the left side of the lever to move backwards.

 = driving backwards

 Do not pull both sides of the throttle control lever simultaneously.

OPERATING THE SCOOTER

8.5 USING THE BRAKES

1. Using the motor electromagnetic brake:

When the throttle control lever is released and returns to the center position, the brake is engaged to stop the scooter.

Emergency braking = let go of the drive lever:



The throttle control lever automatically returns to the central position if you let go, the scooter automatically brakes.

2. Using the handbrake:

To use the handbrake, pull the brake lever (1) slowly towards the handlebar.

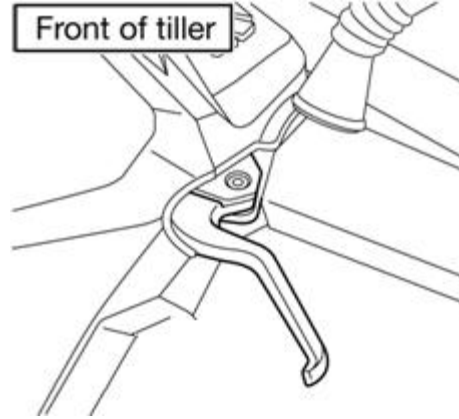

Tipping hazard

*Pulling the brake lever too harshly can cause the scooter to tip over.
Pull the brake lever slowly to brake.*

8.6 OVERLOAD PROTECTION

The overload protection switches the power off when the motor becomes overloaded while trying to climb over too high an obstacle, such as a curb or trying to climb too steep of an incline.

If the motor is overloaded, the following happens:

- The scooter becomes noticeably slower and then stops
- The control system shuts down the scooter

To rectify this:

Switch the scooter off and allow it to cool down for a few minutes.

Switch the scooter on and reverse away from the obstacle (such as a curb) and then avoid the obstacle.

8.7 SWITCHING ON THE HEADLIGHTS

Headlight button :

Switch on = press button once

Switch off = press button again

A switch indicator will light up to show that the headlight is switched on.

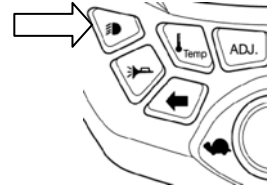

If you drive with the headlights on, the batteries will drain faster and the scooter driving range will be slightly reduced.

8.8 SWITCHING ON THE HORN

Press the **horn button**.

It will sound for as long as you hold the button down.

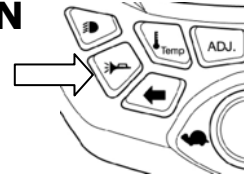

8.9 SWITCHING ON THE HAZARD Lights

Button switch:

Switch on = press button once

Switch off = press button again

The switch indicator will light up to show that the hazard lamps are switched on.



Leaving the scooter with the hazard lamps on will drain the battery.

8.10 SWITCHING ON THE TURN SIGNAL

Turn signal indicating a right hand turn = Press the right arrow switch.

Turn signal indicating a left hand turn = Press the left arrow switch.

When turning is completed, push the switch again to turn the indicators off.

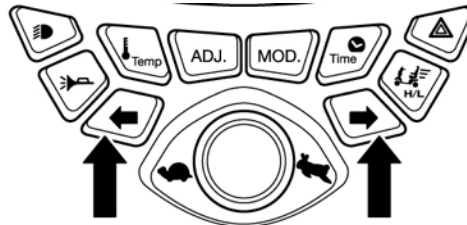

OPERATING THE SCOOTER

8.11 SWITCHING ON THE TEMP

Press the **temp button**.

It will be change the temperature unit of measure.

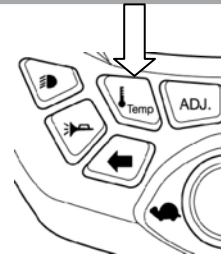

8.12 SWITCHING ON THE ADJ

Press the **ADJ button**.

Hold the ADJ button.

1. set value
2. change speed unit.(km/h or mph)

Hold the ADJ and MOD button about 3 seconds.

The value returns zero.(in TRIP mode)

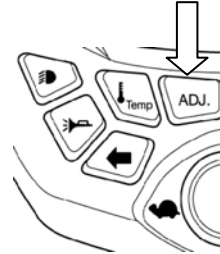

8.13 SWITCHING ON THE MOD

Press the **MOD button**.

Hold the MOD button about 0.5 seconds to repeat CLOCK-> ODO -> TRIP.

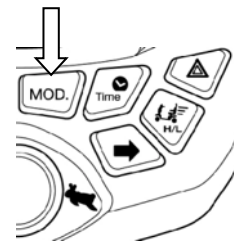

8.14 SWITCHING ON THE TIME

Press the **TIME button**

1. Change between AM/PM display
2. Enter set clock mode /exit set clock mode

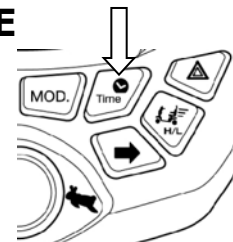

8.15 POWERING OFF/PARKING THE SCOOTER

Turn the key to the left to switch the scooter off.

Always turn the scooter off using the key if you:

- want to get on or off.

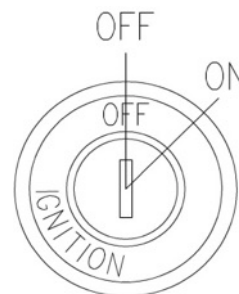

OPERATING THE SCOOTER

- intend to stop for long periods.
- Always remove the key if you:
- want to park the scooter and get off.

8.16 12V POWER SOCKET

The power socket provides 12V 2A
24W

Voltage-12V.

Ampere- 2A.

Watt-24W

Don't exceed the applicable power rating when using.

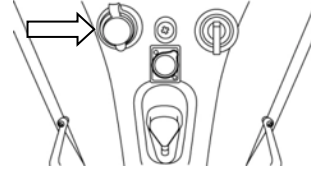

If KEY ON over ten minute,

1. The system will go into the sleep mode status.



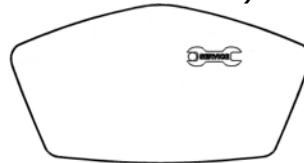

2. Meter LCD will show a signal.

Please reset your key switch (switch off then on).



BATTERY AND CHARGING THE BATTERY

9. BATTERY AND CHARGING THE BATTERY

	Corrosive chemicals contained in battery.
	Explosive conditions exist!
	Warning hands pinching!
	Do not use batteries with different amp-hour (Ah) capacities.
	Keep tools and other metal objects away from battery terminals. Contact with tools can cause electrical shock.
	Flammable material contained in battery. Do not expose to heat sources such as open flame or sparks. Do not transport batteries with flammable or combustible items.
	Disposal and recycling - Contact your approved service provider.

 *New batteries **MUST** be fully charged (approximately 24 hours) prior to initial use of the equipment.*

Always charge new batteries before initial use or battery life will be reduced.

As a general rule, you should recharge your batteries as frequently as possible to assure the longest possible life and to minimize required charging time. Plan to recharge them when you do not anticipate using the equipment.

The range per battery charge, using recommended batteries, should be approximately 8 to 12 hours of

BATTERY AND CHARGING THE BATTERY

typical operation. Extensive use on inclines may substantially reduce per charge mileage.

9.1 BATTERY STATUS DISPLAY

The battery status display on the dashboard shows the current level of battery power.

F = max range

E = decreased driving range, charge batteries as soon as possible.

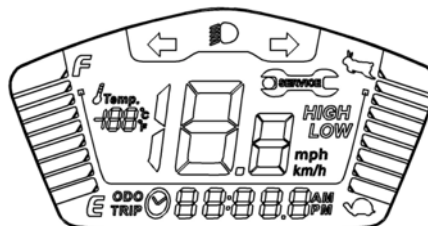

If the scooter is at a standstill, it is often the case that the battery status may show full than it actually is. The battery status display may vary greatly while the vehicle is travelling depending on the load.

If the vehicle is under a heavier load, such as fast acceleration or driving up inclines, the battery status display may move towards the empty zone.

This may not indicate the actual status of the batteries.

After a journey, the battery status display may move towards the full zone after the scooter has been turned off for a long period of time.

If a battery status display is in the empty zone at the end of a journey, the battery must be charged immediately. Otherwise, it can lead to battery damage.



When the LCD shows only 3 spaces of charge units left :

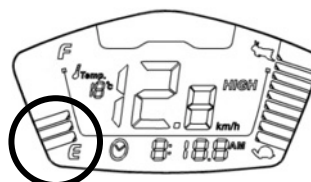

1. At switch off, the system will send out 5 long recharge warning sounds. Then power cuts off.
2. When you switch on, the system will send out 3 short recharge warning sounds.

BATTERY AND CHARGING THE BATTERY

9.2 CHARGING THE BATTERIES

It is imperative that you observe the sequence for connecting and disconnecting the battery charger.

1. Position the scooter near an electric outlet.
2. Switch the scooter **off** and remove the key.
3. Ensure the lever for "freewheel" mode is pushed down to the "drive" position.
4. Connect the battery charger plug into the scooter charging socket located in the centre of the tiller.
5. Plug the battery charging power cord (1) into the socket (2) on the battery charger.
6. Connect the battery charger power plug into an electrical outlet (AC115-230V, 50 to 60 Hz) and charge the battery.
7. It is recommended you charge your batteries for 8 to 12 hours.



CAUTION

Do not share the outlet with any other device.



CAUTION

To avoid the risk of electric shock, this equipment must only be connected to a grounded supply main.



CAUTION

Never use an extension cord to plug in your battery charger.

Step 1. Position the scooter near an electric outlet.

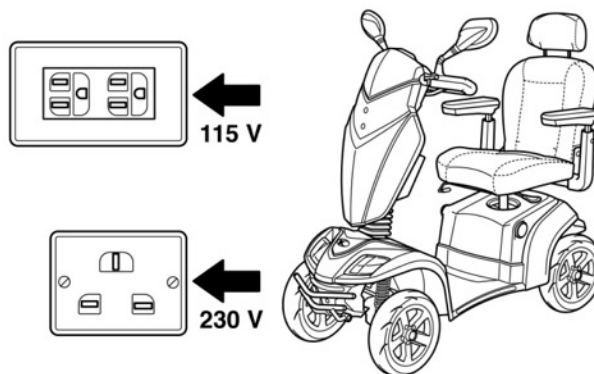

BATTERY AND CHARGING THE BATTERY

Step 2. Switch the scooter off and remove the key.

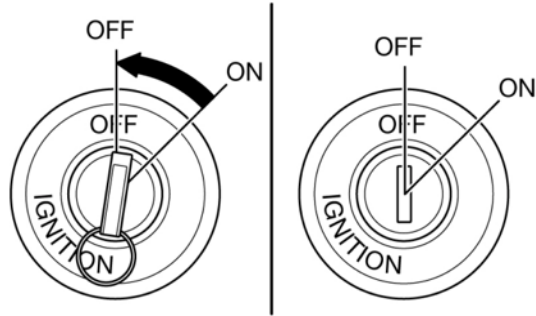

Step 3. Ensure the lever for "freewheel" mode is pushed down to the "drive" position.

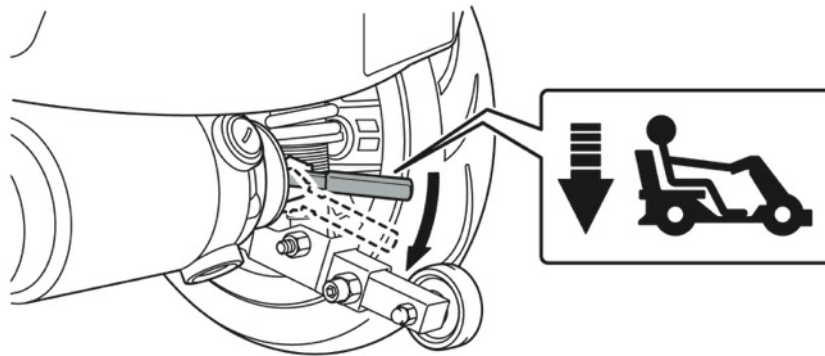

Step 4. Connect the battery charger plug (4) into the scooter charging socket located in the centre of the tiller.

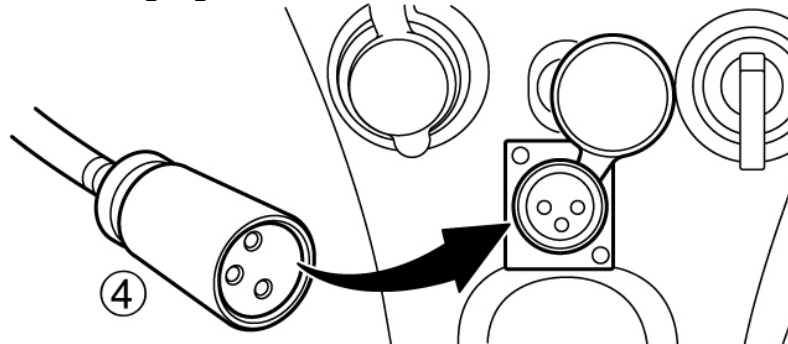

BATTERY AND CHARGING THE BATTERY

Step 5. Plug the battery charging power cord (1) into the jack socket (2) on the battery charger.

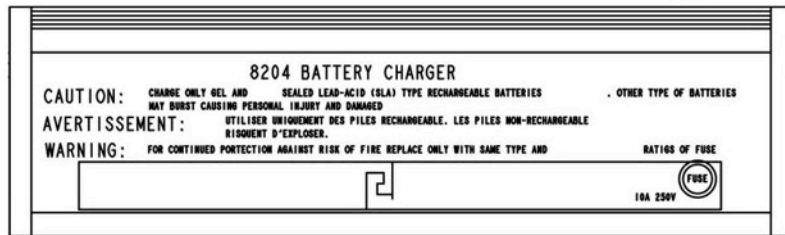
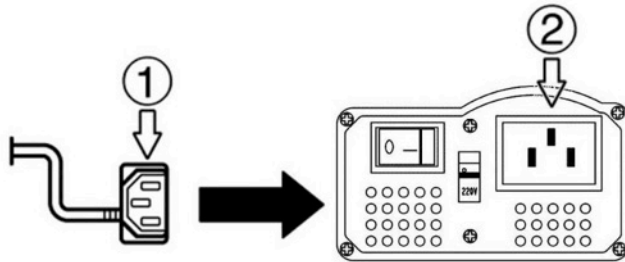

Step 6. Connect the battery charger power plug into an electrical outlet (AC115-230V, 50 to 60 Hz) and charge the battery. (Note: There is no switch on the battery charger).

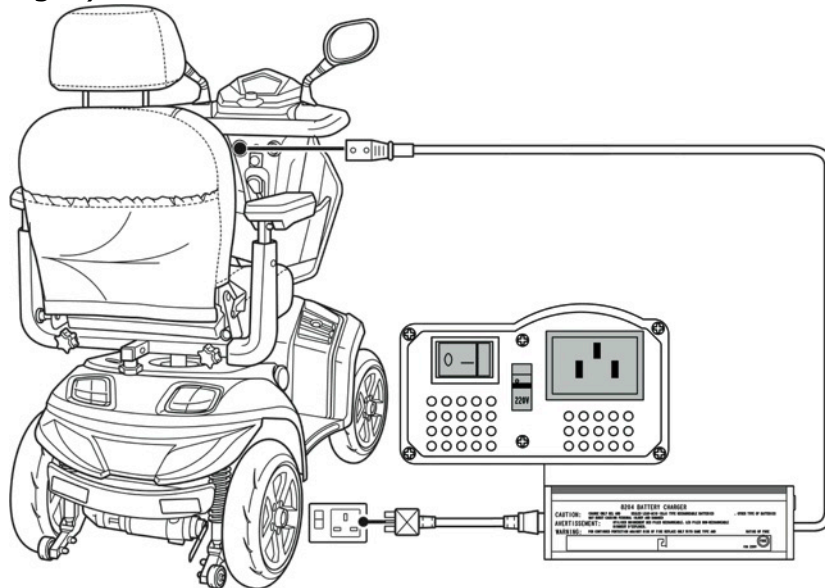

BATTERY AND CHARGING THE BATTERY

LED information at battery charger during Charging:

LED-> Color-> Meaning

1 --- Red --- charging in progress

2 --- Green --- charging is complete

9.3 AFTER CHARGING

(1) Remove the battery charger jack plug from the battery box socket.

(2) Remove the battery charger plug from the electric outlet.

9.4 ERROR CODE

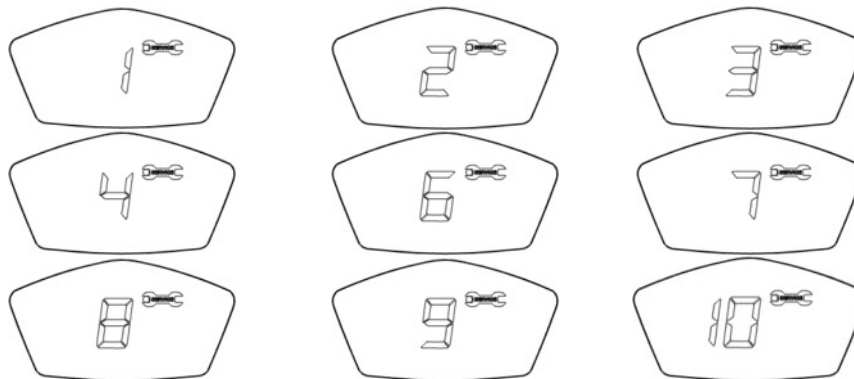

If your meter LCD shows any of the above signals, please contact your approved service provider!

By KWANG YANG Motor Co., Ltd.
First Edition, OCT. 2014
All rights reserved. Any reproduction or
unauthorized use without the written permission of
KWANG YANG Motor Co., Ltd.
is strictly prohibited.
T300-EQ35FA-A1



• NO.35 Wan Hsing Street, San Min District Kaohsiung
City, Taiwan, Republic Of China
• NO.61, Chung-Shan Sth Rd , Lu-Chu
District , Kaohsiung City, Taiwan, Republic Of China
Date printed: Oct. 2014



KWANG YANG MOTOR CO., LTD
No.35 Wan Hsing Street, San Min Distrist
Kaohsiung Taiwan, Republic of China
Telephone: 886-7-3822526
FAX: 886-7-3950021



DESIGN PERFORMANCE RELIABILITY

Kymco Mobility Scooters Australia
19 Pearson Way
Osborne Park
Western Australia 6017
+61 8 9242 7333
sales@kymcomobilityscooters.com.au
www.kymcomobilityscooters.com.au

DISTRIBUTED BY



www.wholesalemobility.com.au