

# HY-PRO®

## TABLE TOP POOL TABLE

# Assembly Instructions

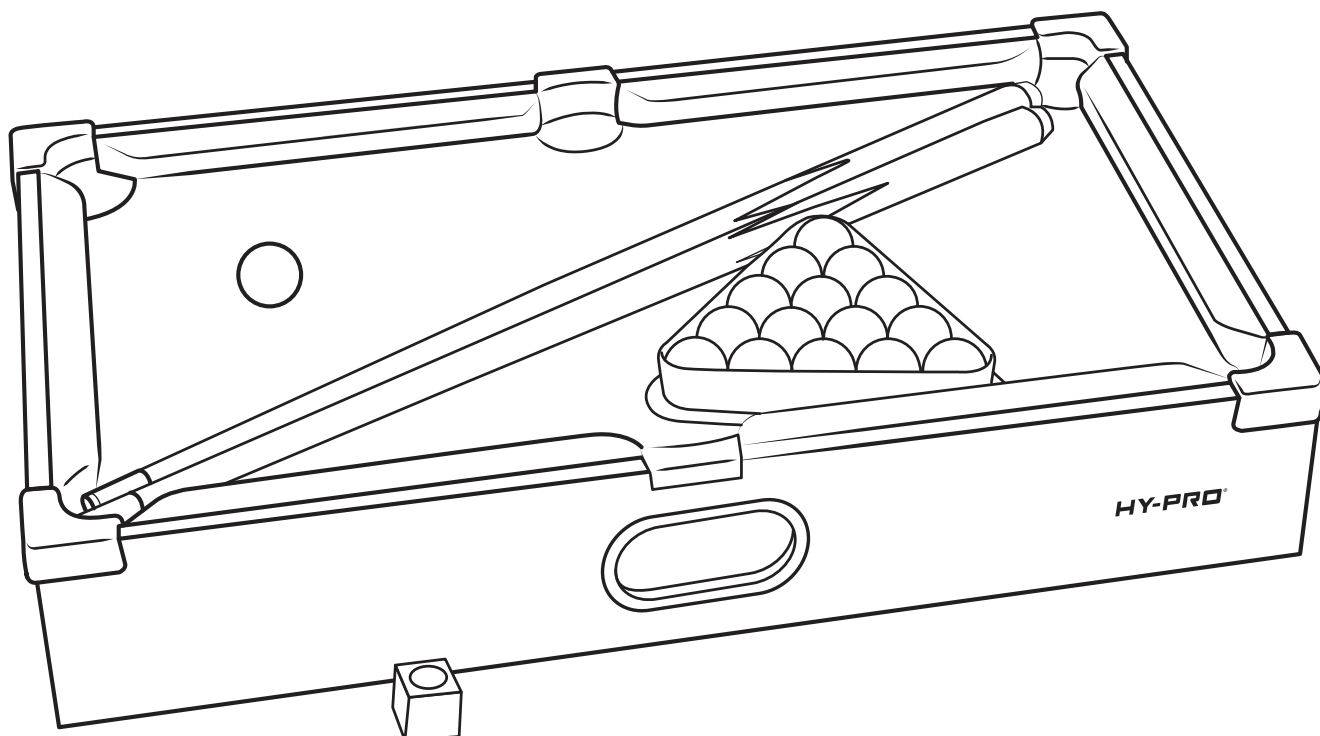

Item No: HP05874



**WARNING:** Not suitable for children under 3 years due to small parts & small balls  
- Choking hazard.

- Caution! Adult assembly required.
- Sharp point on screws; unpack and assemble with care. Keep small parts and polybag away from children during and after assembly. You need a screwdriver (not included) to assemble.

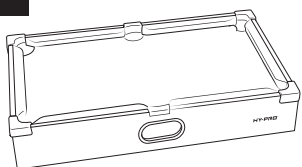
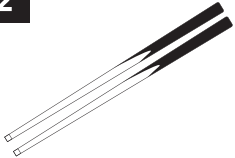
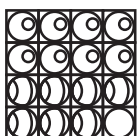
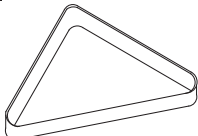
## Accessories List

<b>1</b>  X1	<b>2</b>  X2	<b>3</b>  X1	<b>4</b>  X1	<b>5</b>  X1
-------------------------------------------------------------------------------------------------------	-------------------------------------------------------------------------------------------------------	-------------------------------------------------------------------------------------------------------	---------------------------------------------------------------------------------------------------------	---------------------------------------------------------------------------------------------------------

# How to play 8 ball pool

Eight ball is played with 15 object balls numbered 1 through 15.

One player must pocket balls of the group numbered 1 through 7 (spot balls) while the other player must pocket the group 9 through 15 (stripe balls), finishing by pocketing the black 8 ball.

Place the balls within the triangle in the same pattern as shown in the diagram, with the 8 ball over the black spot.

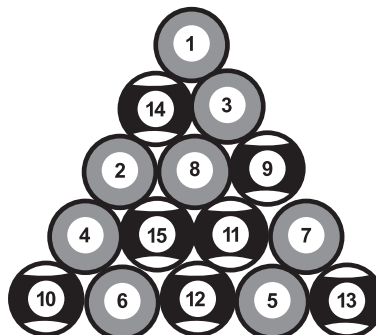

Remove the triangle.

The first player strikes the balls with the white cue ball. Whichever ball is potted (spot or stripe) is the group you will be trying to pot throughout the game. If a ball of both groups is potted, then you may select either.

Carry on potting the selected group until you fail to pot or play a foul stroke.

Your opponent now plays trying to pot his group of balls.

When all are potted, pot the black to win the game.

## You give your opponent a free shot when you:

- pot the cue ball (it is immediately replaced onto its spot).
- miss your ball.
- hit one of your opponents balls first.
- hit the black first (unless, of course you have already potted all of your own group).
- knock a ball off the table (object balls are left off, cue ball on to its spot).

## The game is lost if you:

- pot the black before you have potted all your own group.
- pot the black and the cue ball at the same time.
- pot the black and one of your opponents balls at the same time.

# IMPORTANT!

**Please keep your instructions.** Before attempting assembly, please read through this instruction book to familiarise yourself with all the parts and assembly steps.

We recommended that an adult assembles this game. Please refer to the Parts List inside and be sure that all parts have been included.

**Need help?** Visit our website for replacement parts and product support [www.hyprosports.com/games-tables](http://www.hyprosports.com/games-tables) or call our customer service line on +44 (0) 800 731 0006

## ©Hy-Pro Sports

Manufactured by:

Hy-Pro International  
Hy-Pro House, Centrus Park, Arenson Way,  
Dunstable, Bedfordshire, LU5 5BN, UK

Hy-Pro Europe  
Cube Building, Monahan Road, Cork,  
T12H1XY Republic Of Ireland.

Hy-Pro Asia  
Room 1011, 10/F, Peninsula Centre,  
67 Mody Road, Kowloon, Hong Kong.

Made in China