

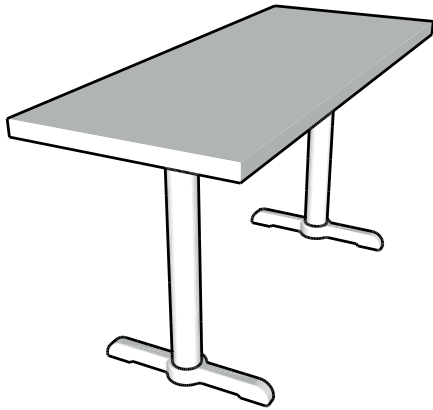







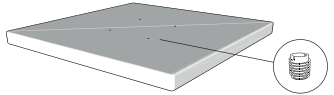

### Tools You'll Need

10mm Spanner (M6) 

17mm Spanner (M10) 



### What's Included

- 1x**  Wood Top (with pre-fitted threaded inserts)
- 2x**  Pedestal Top Plates
- 2x**  Pedestal Bases
- 2x**  Pedestal Uprights
- 8x**  M6 Threaded Bolts
- 2x**  M10 Threaded Rods
- 4x**  M10 Flanged Nuts
- 4x**  Rubber Feet

## Wood Top with Twin Pedestal Chrome Legs

### Installation Guide



#### Safety First!

1. Use caution when handling heavy or bulky components to prevent injury or damage to yourself and the product.
2. Always wear protective equipment, such as gloves or safety glasses, when using power tools to avoid accidents.
3. Do not over-tighten screws or bolts, as this can damage the components or compromise the stability of the product.
4. Please follow the provided instructions carefully to ensure proper assembly and use of the product.
5. Keep small parts away from children or pets, as they can be a choking hazard.
6. Inspect the product for any defects or damages before assembly, and contact us if you notice any issues.
7. Please do not modify the product or use it for any purpose other than its intended use.
8. Use caution when working with sharp tools or edges, and keep them away from children and pets.
9. If you are uncertain about any aspect of the assembly process, seek assistance from a professional or contact us for further assistance.

10. Do not sit or stand on the product.
11. This product is not intended to support people or heavy objects. Avoid placing excessive weight to prevent damage and instability. **MAX 20 Kg**

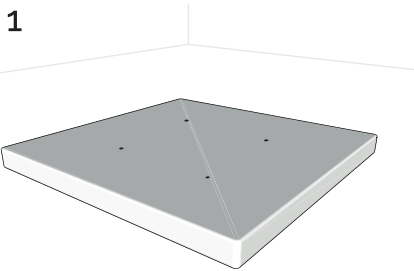
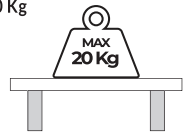

1 Please read the Safety Guidelines stated above before you start assembling the product. To prevent scratching of the surface, place the wood top on a protected surface. Ensure that there is ample space around the top for you to work comfortably.

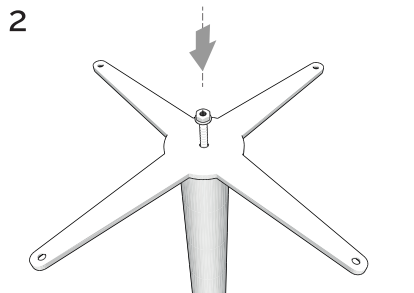

2 Fasten the Top Plate to the upright using the M10 flanged nuts and tighten with a 17mm spanner. **Avoid over-tightening the flanged nut.**

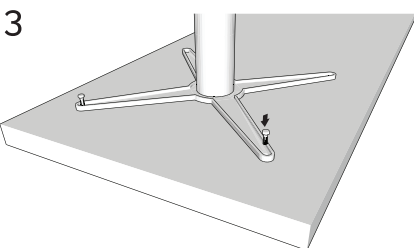

3 Align the top plate holes to the wood top inserts using the provided hex bolts and tighten with a 10mm spanner or socket. **Avoid over-tightening the bolts.**

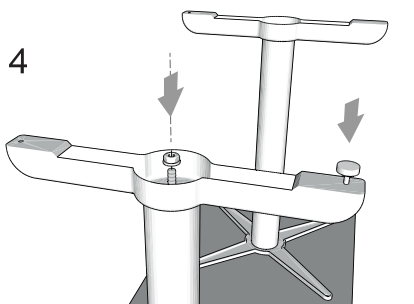

4 Fasten the pedestal base to the other end of the upright with the other M10 flanged nut using a 17mm spanner. Attach the rubber feet to the base. Finally, with assistance from another person, lift the product and stand it upright.

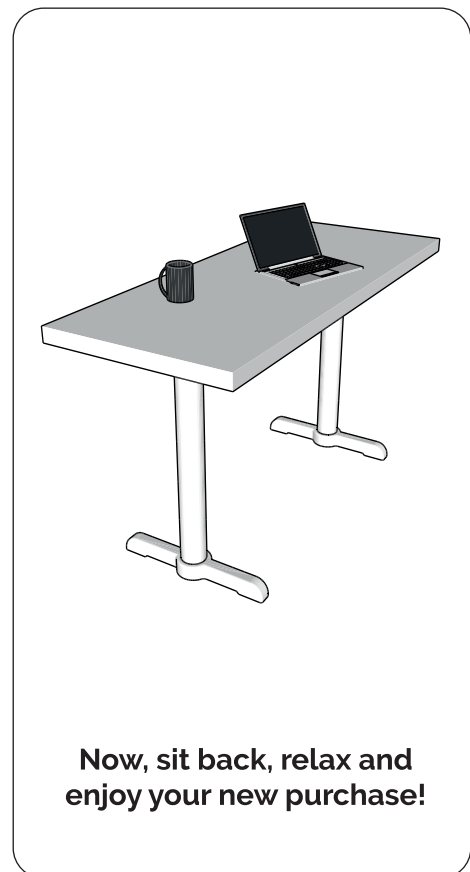

**Now, sit back, relax and enjoy your new purchase!**