



## Tools you'll need

**Electric Impact Screwdriver**  
(Recommended)



OR

**Manual Screwdriver**



## What's included

**1x**

**Wood Top**

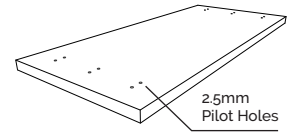

**2x**

**Black Square Legs**



**12x**

**Black Pan Head Screws**  
M5 x 25mm



**4x**

**Rubber Feet**

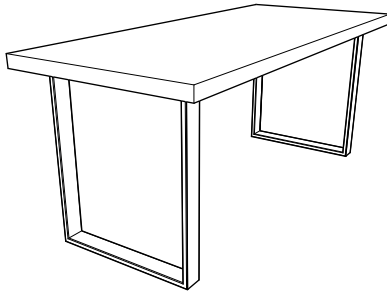

# Wood Top with Square Legs

## Installation Guide



### Safety First!

1. Use caution when handling heavy or bulky components to prevent injury or damage to yourself and the product.
2. Always wear protective equipment, such as gloves or safety glasses, when using power tools to avoid accidents.
3. Do not over-tighten screws or bolts, as this can damage the components or compromise the stability of the product.
4. Please follow the provided instructions carefully to ensure proper assembly and use of the product.
5. Keep small parts away from children or pets, as they can be a choking hazard.
6. Inspect the product for any defects or damages before assembly, and contact us if you notice any issues.
7. Please do not modify the product or use it for any purpose other than its intended use.
8. Use caution when working with sharp tools or edges, and keep them away from children and pets.
9. If you are uncertain about any aspect of the assembly process, seek assistance from a professional or contact us for further assistance.
10. Do not sit or stand on the product.
11. This product is not intended to support people or heavy objects. Avoid placing excessive weight to prevent damage and instability. **MAX 40 Kg**

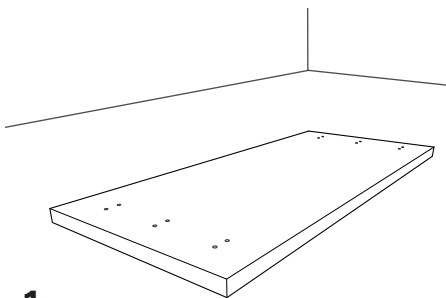

**1**

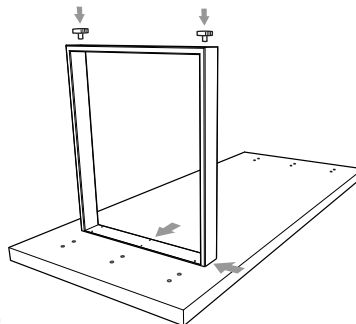

**2**

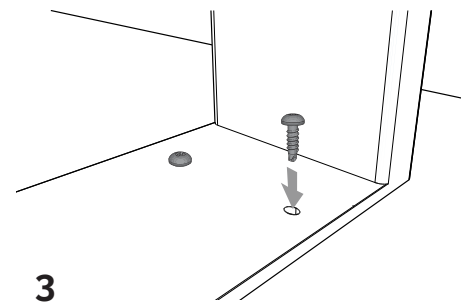

**3**

Please read the **Safety Guidelines** above before you start to assemble the product. To prevent scratching of the surface, place the top on a protected surface or carpet and make sure that the underside of the product is facing upwards. To allow you to work comfortably, ensure ample space around the top.

There is a certain level of tolerance between each component. The legs are matched to the top before despatch. To ensure that the legs are properly aligned with the holes, it is recommended that you place each leg over the accompanying holes to ensure that the fittings marry up before securing them. Please note that the orientation of the leg can be in two directions. Screw the rubber feet in place.

Secure the legs in position and fasten them to the top using the provided pan head screws and an electric/impact screwdriver (recommended) ensuring a secure attachment of the legs. Tighten the screws to 60%, when all are in position, you can then fully tighten. **Avoid over-tightening the screws.**

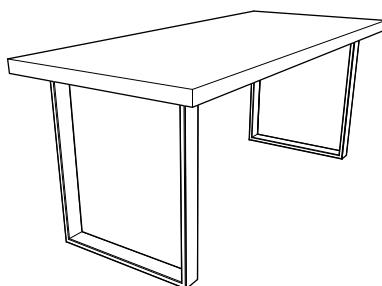

**4**

Finally, with assistance from another person, lift the product and stand it upright.

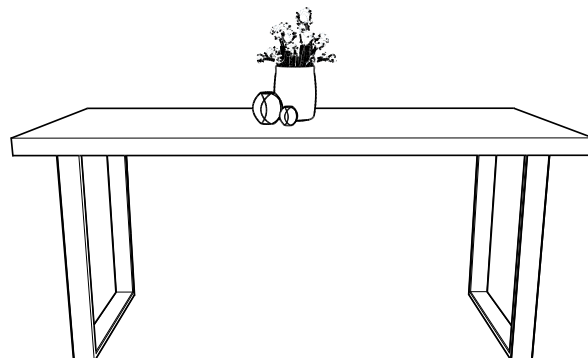

**Now, sit back, relax and enjoy your new purchase!**