

VEYMAX ELECTRIC SKATEBOARD

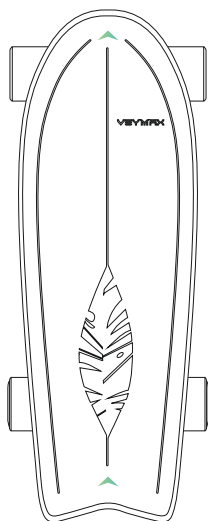

USER MANUAL



IMPORTANT SAFETY INFORMATION



DO NOT RIDE BEFORE READING AND UNDERSTAND USER MANUAL

Read the User manual carefully before riding on your Veymax Skateboard and keep it for reference. This User Manual is a quick start guide, It contains important safety information, warning messages, product specifications, functions and service informations.



RESPONSIBILITY FOR RIDER REGARDING REGULATIONS

It is the responsibility for the rider to obey the regulation when you ride your Veymax Skateboard.

The regulations involves the use of your Veymax Skateboard differ in state/province and even municipality in certain locations. You must obey the local regulations, like the minimum age, license plate, traffic, maximum speed and any other regulations, so always comply with the law.



WARNING

DO NOT RIDE ON BUSY ROADS WITH LINE MARKINGS.

ALWAYS RESPECT PEDESTRIANS

⚠ WARNING MESSAGES ⚠

⚠ Please read and understand entire warning messages before riding your Veymax electric skateboard.

- 1.** Riding your Veymax electric skateboard is extremely dangerous. Whenever you ride your Veymax board, it may cause bodily injury, disability, or death from loss of control, collision, or falls, always keep safety is your top priority.
- 2.** The throttle is extremely sensitive when riding your board on the mode of Pro, which may cause falling. Please try to ride on your comfortable speed to ensure safety.
- 3.** Ride only in an open area free from vehicles and pedestrian traffic, and other physical obstacles. It is your responsibility to master the basic operations, like accelerating, braking and switching gears. During the riding, wearing a helmet and full protective gear is necessary.
- 4.** Only ride in areas with good visibility, do not ride on uneven areas or slippery.
- 5.** The Veymax electric skateboard is not a toy and is not intended for children under the age of 16.
- 6.** Always wear a helmet and protective gears while riding your Veymax electric skateboard. Wearing protective gear can prevent serious injury, like helmet, pads and knee pads. And also it is important to wear athletic shoes to well control the wheels and the drive system.
- 7.** Ride on hills and high speeds can be extremely dangerous. Be extra careful while pushing the limits of the skateboard. No matter you are beginner or experienced, it may cause crashes with serious injury.

WARNING MESSAGES

8. It is more dangerous for riding at night, people may difficult to see you and you may not see obstacles during your riding. You should install the light on your board as a signal or wear your clothing or helmet with lights.

CAUTION

DO NOT RIDE IN WET AREA

Riding in wet conditions will drastically decrease grip, as the wheels slipping or sliding. It will also cause the board to stop suddenly or lose power.

The warranty does not include damage to the board due to water exposure.

PINCH POINT

Keep fingers, hair, clothing (including shoelaces) jewelry and other objects away from motors, belts, wheels and all moving parts.

DO NOT TAMPER WITH BOARD PARTS

Never change or open your battery case in any way, do not modify or install incompatible hardware or components on it, this operation will void the warranty of your board.

1 VEYMAX MINI NANO

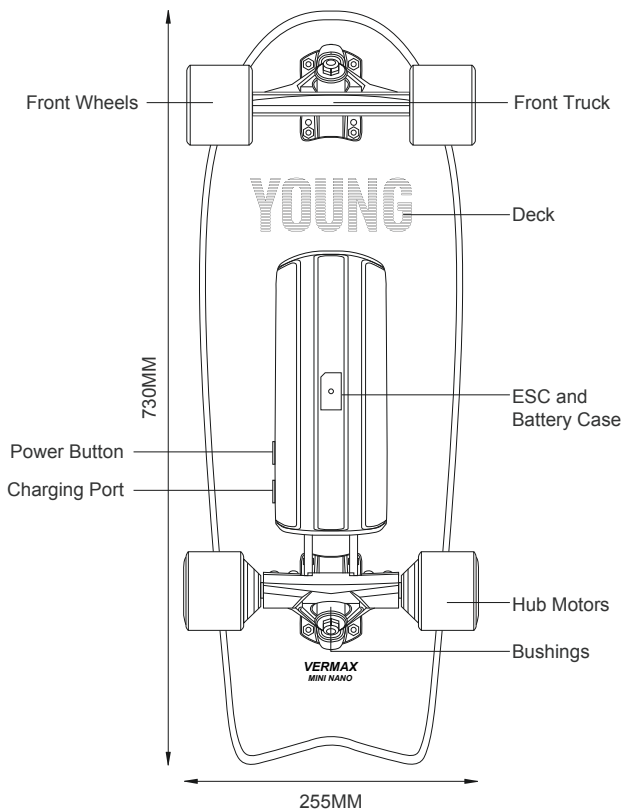

2 V4S REMOTE

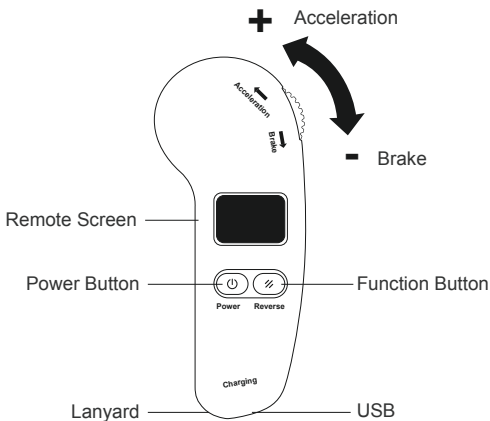

REMOTE SCREEN GUIDE

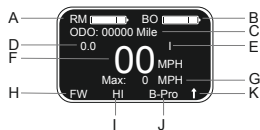

- | | |
|-------------------------------------|-------------------------------|
| A: Remote Control Battery Remaining | G: Max Speed |
| B: Skateboard Battery Remaining | H: Go Ahead(FW) Step Back(BW) |
| C: Total Mileage | I: Speed Mode |
| D: Single Mileage | J: Brake Mode |
| E: Speed Mode | K: Signal Indication |
| F: Speed Meter | |

Product	MINI NANO
Maximum Speed	30km/h
Cruising Range	13km
Speed Mode	4
Battery Capacity	4.2Ah
Battery Voltage	21.6
Battery Power	90.72Wh
Battery Pack	6S1P
Motor power	200w X 2
Charging Time	5h
Weight	5.5kg
Max Load	100kg
Maximum Slope	10
Wheel Size	75mmx56mm
Waterproof	IP5

4

GET READY TO START

 **PROTECTIVE GEARS**

Wear a helmet and protective pads, knee pads can reduce risk and prevent serious injury.

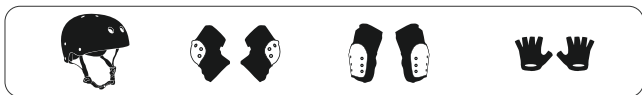
 **FOOT STANCE**

Foot stance varies from person to person. Always be in what you feel best position.

Try both stances to see what feels best. stand with your feet in the widest part of the skateboard(as shown below). when you are turned, you can move the back foot forward to adjust to the direction and comfortable position.

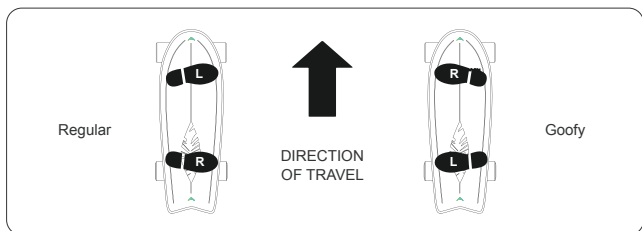
 **STANCE**

- Make sure the direction is correct before riding the board.
- Hold the remote wheel to move the throttle in small increments.
- Keep the brakes on when learning to turn the board.
- Keep a low center of gravity.
- Try to lean back when braking and lean forward when accelerating.

5 POWER ON/OFF THE BOARD

To turn the board on, press the **ON/OFF power button**, beep with red light shows the board is on.

To turn the board off, just press the **ON/OFF power button** again, and the red light is off.

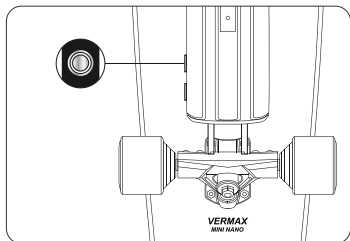

THE BOARD WILL TIME OUT AFTER 5 MINUTES OF NON-USE, IN WHICH CASE ALTHOUGH THE SWITCH IS STILL IN, THE LIGHT WILL TURN IT OFF. TO REACTIVATE THE BOARD, IT WILL HAVE TO BE TURNED OFF, AND BACK ON AGAIN.

6 POWER ON/OFF THE REMOTE

To turn the remote ON, press the **ON/OFF button** for 3 seconds, the LCD screen will display all functions and information.

To turn the remote OFF, press and hold the **ON/OFF button** for 3 seconds or until the screen turns off.

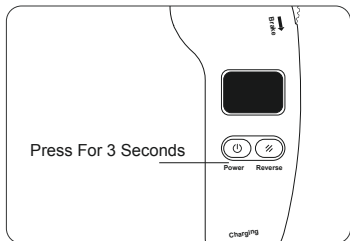

TIPS: ALWAYS TURN THE BOARD ON 1ST AND THE REMOTE ON 2ND.

7 ENSURE THE REMOTE PAIRING/SYNCING

Your Veymax board and remote have already been paired /synced during the manufacture. Pairing/syncing a new remote of your board, please follow the below procedure:

- ➊ To turn the board on by pressing the power button on your Veymax board once.
- ➋ To turn the remote on by pressing the “ON/OFF” button on your remote.
- ➌ If you have the old remote, please make sure it is turned off.
- ➍ Hold the power button on your board for 7 seconds, until it blinks slowly.
- ➎ At the same time, press the “ON/OFF button” and “function” buttons on your remote.
- ➏ When the power button blinks rapidly and the remote displays all the function and information, it is indicated your board and remote have been paired and synced.

8

RIDING THE BOARD WITH THE REMOTE

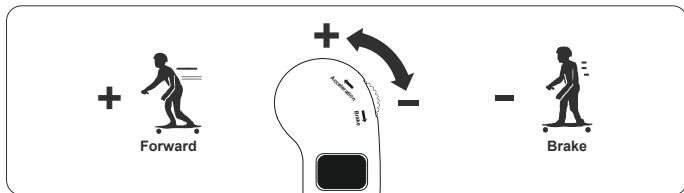

The way to accelerate/brake

**CAUTION**

PRO MODE IS MUCH MORE POWERFUL AND THE TRIGGER IS HIGHLY SENSITIVE.

9

CHECK THE BATTERY POWER ON THE REMOTE

Before riding, please check your board and remote battery capacity. The battery capacity will display on the LED screen of your remote that indicates how much power you have left. Before riding, do not let the battery power runs out.

Remote Control
Battery Remaining

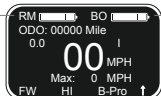

Skateboard
Battery Remaining

10 CHANGE RIDE SPEED MODE ON REMOTE

Once the remote is paired to your Veymax board, the speed mode will be in **LO** mode is beginner friendly.

WARNING

Make sure you have mastered the **LO** mode before changing the modes.

LO: Limited acceleration, top speed of 11km/h (7mph).

MI: Moderate acceleration, top speed of 25km/h (15.5mph).

HI: High acceleration, top speed of 45km/h (28mph).

PRO: Max acceleration, top speed of 45km/h (28mph).

The maximum speed of each mode will change under the influence of different terrain, environment and load weight.

WARNING

The board throttle wheel is very sensitive in the mode of **HI/PRO**, To prevent serious injury and being thrown off, please follow these tips below:

Make sure the direction is correct before riding the board.

Hold the remote wheel to move the throttle in small increments.

Keep the brakes on when learning to turn the board.

Keep a low center of gravity.

Try to lean back when braking and lean forward when accelerating.

11 CHARGING THE BOARD

Before riding the board, please check the battery capacity, if the power is not enough, connect power to the charger by inserting the charger plug into a power point.

The charger will display:

- GREEN LIGHT=FULLY CHARGED
- RED LIGHT=CHARGING

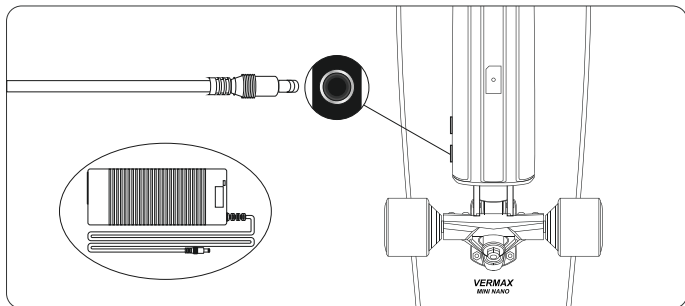

⚠ WARNING

NEVER LEAVE YOUR BOARD UNATTENDED WHILE CHARGING.

NEVER CHARGE THE BATTERY IF YOU NOTICE THE BATTERY IS DAMAGED, LIKE HOT, LEAKING, SMELLS, OR DISCOLOURED.

ONLY USE THE ORIGINAL VEYMAX SKATEBOARD BATTERY CHARGER.

12 CHARGING THE REMOTE

To charge the remote, insert the USB plug of the charging cable carefully into the charge port of the remote, and the USB plug end into a suitable USB port.

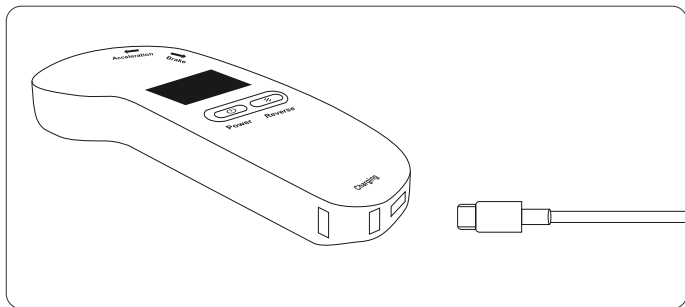

WARNING

CHECK YOUR REMOTE BEFORE RIDING, AVOID THE REMOTE IS LACKING THE BATTERY.

ENSURE THE REMOTE IS FULLY CHARGED, JUST REMOVE THE USB PLUG FROM THE REMOTE.

13 PRODUCT PART LIST

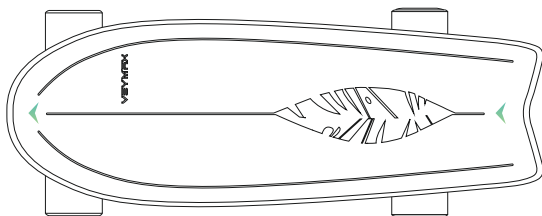

VEYMAX MINO NANO

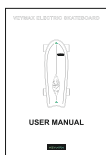

**User
Manual**



**V4S
Remote Control**



**Fast UL
Charger**



**Charging
Cable**

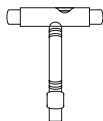

**Veymax T
Skate Tool**

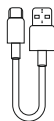

**Remote Control
Charger**

**BATTERY SAFETY AND CARE**

1. If the battery pack is replaced incorrectly, it may cause the risk of explosion. Carefully dispose of the used batteries following the instructions.
2. If do not follow the batteries safety instructions, it could cause electric shock, in fire, or another serious injury.
3. Do not leave your battery unattended while charging.
4. Keep the battery pack away from children.
5. Keep the battery pack completely dry and never expose the battery pack to any liquids.
6. Battery can not be crushed or punctured by any other object, it may be damaged.
7. Open, change or modify the skateboard non-approved by Veymax, it may void any warranty claims.
8. Only use the original Veymax skateboard battery charger, never use non-approved batteries charger or another charger with your Veymax board's battery pack, it may cause damage or risk of explosion.
9. Stop charging or storing immediately the battery pack and the remote if you discover it becomes abnormally hot, such as smells, leaks, discoloration, deformation, cracked, swollen or shows any other signs of damage.
10. Your equipment includes an internal rechargeable lithium-ion battery which may cause fire or chemical burns if mishandled. Always protect it against heat e.g., temperature $>60^{\circ}$ Celsius (140° F) when charging or using.

14 WARNINGS INFORMATION

11. Once the battery is fully charged or finished that shows light green, the charger will automatically stop charging. If the light does not show, that means the battery is still charging.
12. Battery charged will be taken 3-4 hours if the power is almost run off.
13. When the battery gets charged, it may occur hot, carefully use and avoid touching the battery pack.
14. Always check the charger supplied by Veymax for damage, like the cable, plug, enclosure and other parts. If such an issue, do not charge until it is repaired or replaced.
15. Pay attention to the household voltage! The supply voltage must strictly comply with the specifications given on the nameplate.
16. Your equipment should not be placed in municipal waste and never put the used batteries with other ordinary solid wasters. Please review the local regulations that apply to all the proper disposal of electronic products.
17. Do not drop or throw the battery, never throw the battery into a fire, it could cause the risk of explosion.
18. Do not put the charger or the battery pack near flammable materials or metal object, make sure the battery is completely dry before charging and unconnected with another metal object that will short-circuit, short-circuit may cause serious injury, damage or the risk of explosion.

WARRANTY AND MAINTENANCE

You have the right to enjoy all warranty and maintenance regarding to your Veymax board.

WARRANTY

Veymax provides 6 months of the manufacturer's warranty includes defects in material and workmanship, and also 3 month's warranty for parts (When customers buy the parts separately) which start from the day the package is delivered to customers. The warranty does not involve damage caused by artificial damage, such as damage from violence, modifications, unauthorized repairs and failure to follow the instructions in the user manual, damage caused by negligence, including using the battery for a long time with high power but not timely charging, or other damage caused by abuse.

During the warranty period, If your equipment has a manufacturing defect, please contact Customer Service by emailing **service@veymax.com**.

For more warranty claims and details, please contact Veymax's customer service by going to **www.veymax.com** or call us on cellphone number +**13475932654**. The warranty or return needs the package materials, please keep your shipping box.

MAINTENANCE YOUR BOARD

Always store your Veymax Skateboard indoors in a dry area to avoid unrecoverable battery pack damage, it is recommended to charge your board once a month. If you are not going to ride your Veymax Skateboard for 1 month, please keep your board battery power between 40%-50% to prevent the total battery capacity loss permanently.

WARRANTY AND MAINTENANCE

Regularly check and clean the belt and drive gear for any damage and replace them if necessary. please make sure the cleaning products may involve solvents. Only use dry cloth & damp to clean your board from dirt and dust to keep and ride as new.

If you ride in the rain or on wet roads, please wipe the water clean from your board, especially the charging port. Without wiping off the water, the charging port and the inside of the motors may cause rust, short-circuit or even risk of explosion.

 **Facebook: @veymaxboard**

 **Youtube: @veymaxboard**

 **Instagram: @veymaxboard**

 **Online Store: www.veymax.com**

 **Customer Service Email Address: service@veymax.com**



VEYMAX

www.veymax.com