





# GENUINE SCUFF PLATE

## INSTALLATION AND USER'S INSTRUCTIONS

Thank you for purchasing a genuine Mazda accessory.  
Before removal and installation, be sure to thoroughly read these instructions.  
Please read the contents of this booklet in order to properly install and use the scuff plate. Your safety depends on it.  
Keep these instructions with your vehicle records for future reference.

### **WARNING**

- There are several  **WARNING** and  **CAUTION** sections in this booklet concerning safety installing or removing the scuff plate. Always read and follow them in order to prevent injuries, accidents, and possible damage to the vehicle.  
 **WARNING:** Indicates a situation in which serious injury or death could result if the warning is ignored.  
 **CAUTION:** Indicates a situation in which bodily injury or damage to the vehicle could result if the caution is ignored.
- Do not modify the scuff plate.
- Do not install the scuff plate in any way other than described in the following instructions.
- If in any doubt, please ask your Mazda dealer to install the accessory in order to prevent errors in installation.
- If you have any questions about the use of the accessory, ask your Mazda dealer for proper advice before using it.
- Mazda and its suppliers are not responsible for injuries, accidents, and damage to persons and property that arise from the failure of the dealer or installer to follow these instructions.
- To ensure safety and reliability of the work, installation, removal and disposal work must be carried out by an Authorized Mazda Dealership.
- Be careful not to lose removed parts, and be sure that they are kept free from scratches, grease or other dirt.

**PART NAME: SCUFF PLATE**  
**PART NUMBER: NE51 V1 370F**  
**VEHICLE: MX-5**

#### Note

##### To the dealer

- Please turn over these instructions to the customer after installation.

##### To the customer

- Keep these instructions after installation. The instructions may be necessary for installing other optional parts or removal of this accessory.
- Should the vehicle or this accessory be resold, always leave these instructions with it for the next owner.

# 1 INSTALLATION VIEW

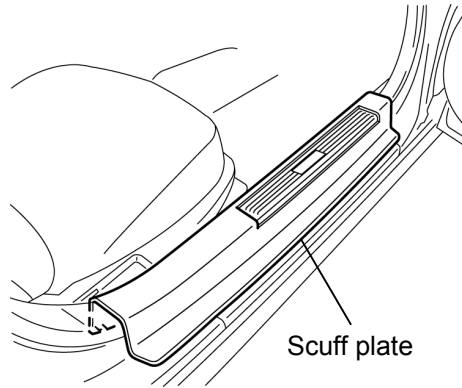

# 2 PARTS

**Note**

- Before installation, verify that the kit includes all the following parts and that parts are not dirty, scratched, or damaged.

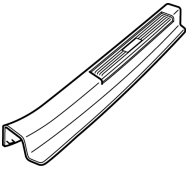
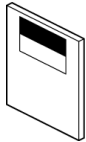
Part	Part name	Qty.	Part	Part name	Qty.
	Scuff plate (RH, LH) (RH:NE51 V1 375F) (LH :NE51 V1 376F)	1ea.		Installation and User's instructions	1

# 3 REQUIRED TOOLS

- ★Fastener remover

# 4 BEFORE INSTALLATION

**⚠ CAUTION**

Be sure to cover the vehicle body With protectors or mats to Prevent stains, scratches and damage when removing/installing the vehicle parts

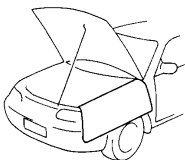

Use the most appropriate (size, use) tool for each task and perform the may be damaged.

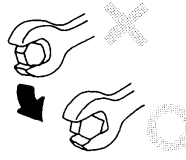

Place the removed parts and kit accessories on a protective sheet to prevent scratches.

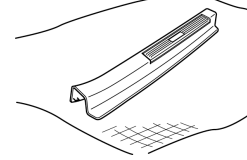

**Note**

- Refer to the Workshop Manual for removal and installation of vehicle parts. Not following the procedures for removal/installation in the Workshop Manual could result in an accident or vehicle malfunction.

## 5 PART REMOVAL

### Note

- The directions are given for the right side, however, the directions for the left side are the same.

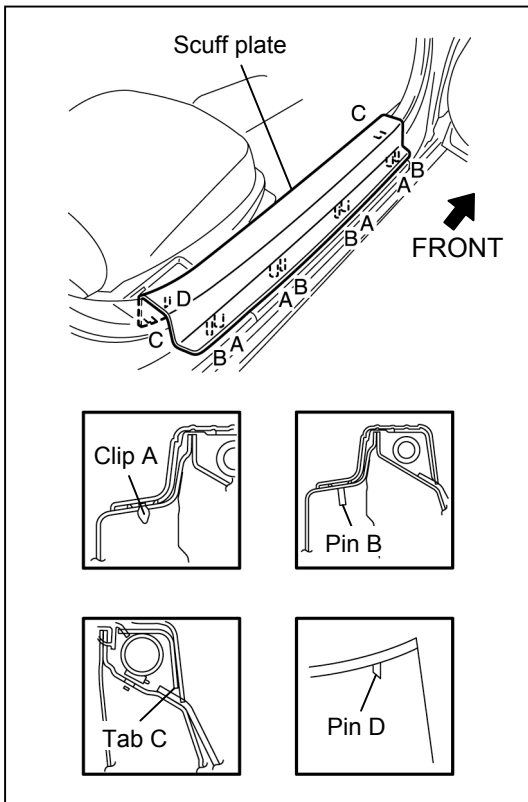

1. Open the door fully.
2. Pull the scuff plate upward while detaching tabs C (2) and Then detach clips A and pins B (4), pin D (1) from the body, and remove the scuff plate.

### ⚠ CAUTION

- The removed scuff plate are not used to install this accessory.

## 6 SCUFF PLATE INSTALLATION

1. Install in the reverse order of the part removal.

## 7 CAUTION AFTER INSTALLATION

### CAUTIONS ON HANDLING

- If the scuff plate becomes dirty, clean it in the same way as the surface of the body.
- Do not use thinner, benzene, gasoline or any organic solvent. They will cause damage to the surface of vehicle and installed parts.

# INSTALLATION INSPECTION SHEET

**MX-5**

**SCUFF PLATE**

**NE51 V1 370F**

## Inspection items after installation

- Inspect the installed/reinstalled parts for the following items.

Part	Check item ( )		
	Clearance/Fit	Scratches/Dirt	Installation/ Engagement
Scuff plate			

Installation inspection sheet for scuff plate

Date _____, _____, _____					
VIN. _____					
Approved		Checked		Person in charge	

The term of validity for this sheet: 3 months