





# GENUINE TONNEAU COVER

## INSTALLATION AND USER'S INSTRUCTIONS

Thank you for purchasing a genuine Mazda accessory.  
Before removal and installation, be sure to thoroughly read these instructions.  
Please read the contents of this booklet in order to properly install and use the tonneau cover. Your safety depends on it.  
Keep these instructions with your vehicle records for future reference.

### **WARNING**

- There are several  **WARNING** and  **CAUTION** sections in this booklet concerning safety when installing or removing the tonneau cover. Always read and follow them in order to prevent injuries, accidents, and possible damage to the vehicle.
  -  **WARNING:** Indicates a situation in which serious injury or death could result if the warning is ignored.
  -  **CAUTION:** Indicates a situation in which bodily injury or damage to the vehicle could result if the caution is ignored.
- For areas indicating the tightening torque in this instruction manual, tighten to the specified torque using a torque wrench. For areas in which the tightening torque is indicated inside parentheses ( ), the tightening torque is indicated as a reference value, however tightening using a torque wrench is not necessary.
- Do not modify the tonneau cover.
- Do not install the tonneau cover. In any way other than described in the following instructions.
- If in any doubt, please ask your Mazda dealer to install the accessory in order to prevent errors in installation.
- If you have any questions about the use of the accessory, ask your Mazda dealer for proper advice before using it.
- Mazda and its suppliers are not responsible for injuries, accidents, and damage to persons and property that arise from the failure of the dealer or installer to follow these instructions.
- To ensure safety and reliability of the work, installation, removal and disposal work must be carried out by an Authorized Mazda Dealership.
- Be careful not to lose removed parts and be sure that they are kept free from scratches, grease or other dirt.

**PART NAME: TONNEAU COVER**

**PART NUMBER: TK78 V1 350**

**VEHICLE: MAZDA CX-9**

### **NOTE**

#### **To the dealer**

- Please turn over these instructions to the customer after installation.

#### **To the customer**





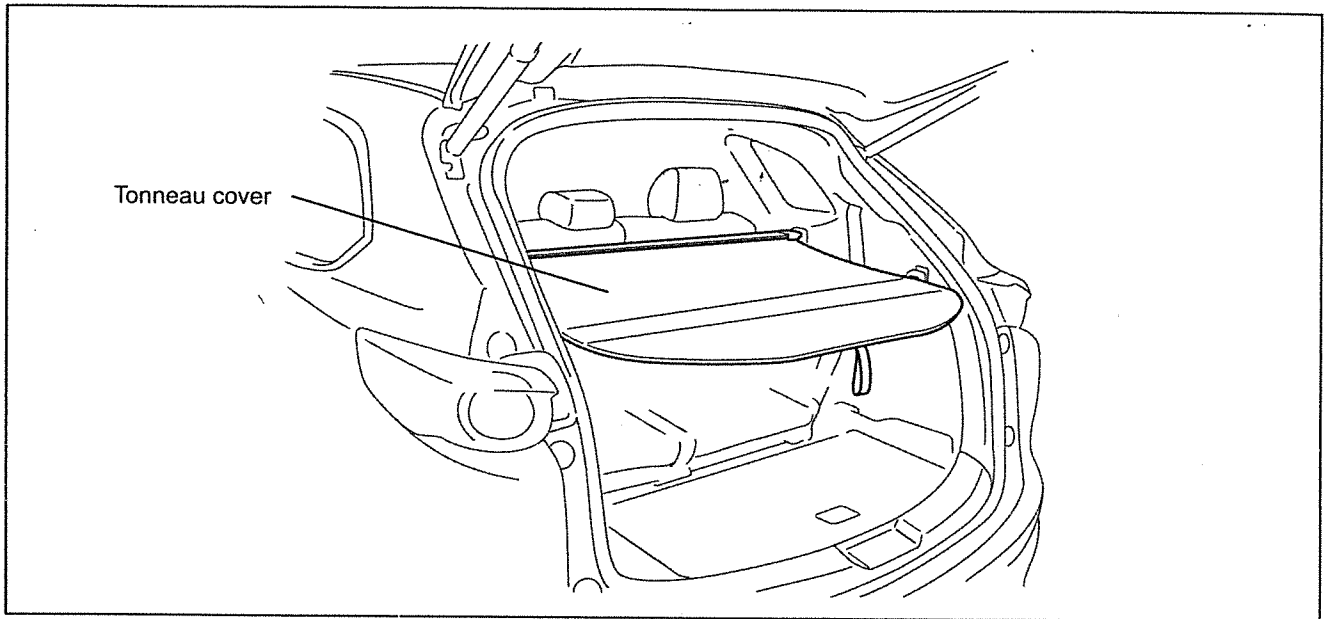

- Keep these instructions after installation. The instructions may be necessary for installing other optional parts or removal of this accessory.
- Should the vehicle or this accessory be resold, always leave these instructions with it for the next owner.

## 1. INSTALLATION VIEW

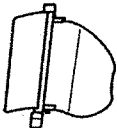
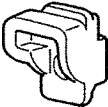

## 2. PARTS

The following parts are included with the genuine tonneau cover. Before installation, verify that the kit includes all the following parts and that they are free of dirt, scratches, or damage.

Part	Part name	Qty.	Part	Part name	Qty.
	Tonneau cover	1		Catch RH/LH	1ea.
	Trim cover RH/LH	1ea.		Protective tape rectangle	4
	Protective tape square	2		Protective tape Diamond RH/LH	1ea.
	Installation and user's Instructions	1			

### 3. BEFORE INSTALLATION

#### ■ REQUIRED TOOLS

☆Screwdriver

☆Deep socket wrench(10 mm)

☆Torque wrench

☆Isopropyl alcohol (IPA)

☆Fastener remover

#### ⚠ WARNING

Park the vehicle on a flat, level surface, set the selector lever to P (AT vehicles) or the shift lever to 1st or R (MT vehicles), apply the parking brake and block the wheels so that the vehicle does not move during installation.

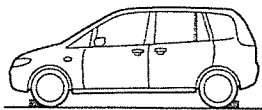

#### ⚠ CAUTION

Be sure to cover the vehicle body with protectors or mats to prevent stains, scratches and damage when removing/installing the vehicle parts

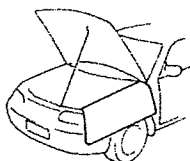

Using improper tools may cause damage and or broken parts. Use the correct tool for the job.

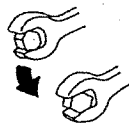

Put the removed parts and the parts in the kit on a protective sheet to prevent scratches.

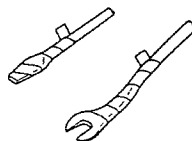

#### Advice

Refer to the Workshop Manual for removal and installation of vehicle parts.



## 4. TONNEAU COVER FITTING PARTS INSTALLATION

- The figure shows the right side, however, perform the same procedure for the left side.

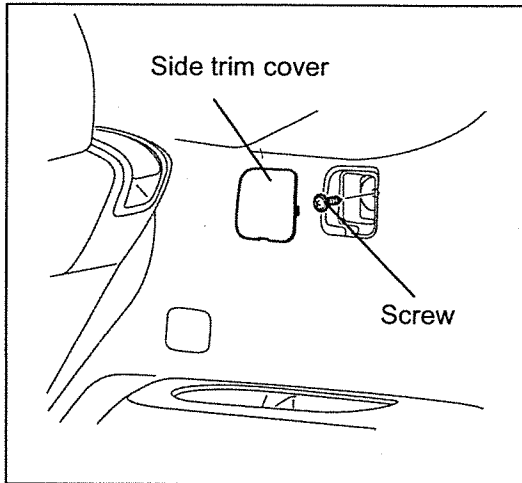

1. Remove the side trim cover and then remove the screw.

- The screw is necessary for reinstallation. Be careful not to lose it.
- Return the removed side trim cover to the customer.

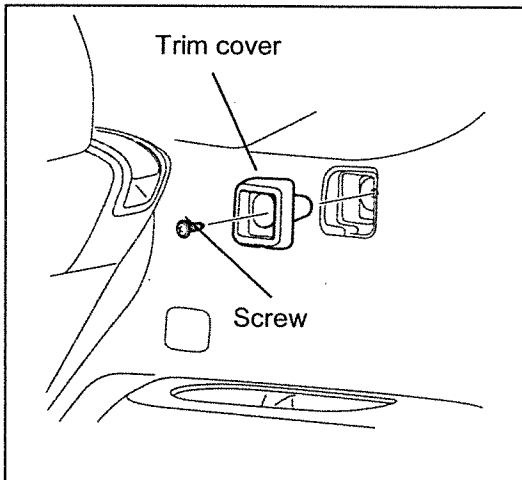

2. Insert the trim cover (RH), and install it using the screw removed in Step 1.

(Tightening torque 2.0 - 3.0 N · m)

### ADVICE

- There is a RH and a LH trim cover. Check the marking on the back of the part.

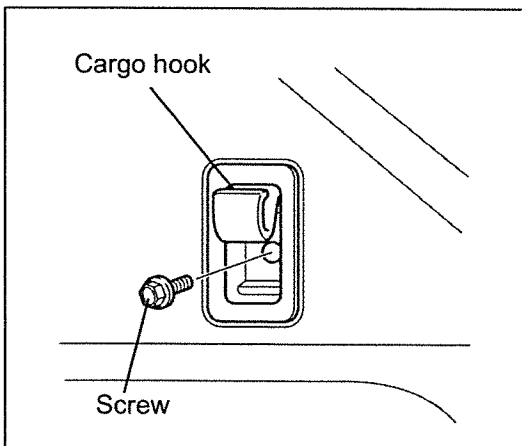

3. Remove the screw and then remove the cargo hook.

- The screw is necessary for reinstallation. Be careful not to lose it.
- Return the removed cargo hook to the customer.

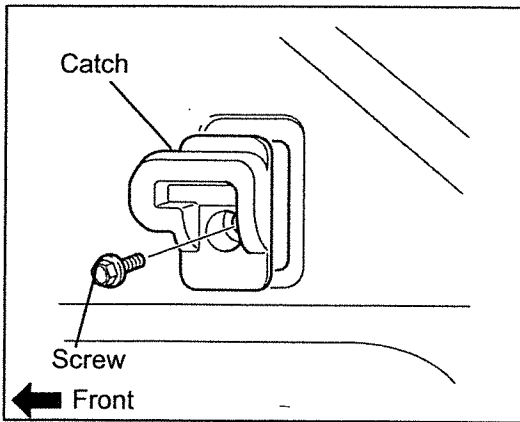

4. Insert the catch (RH), and install it using the screw removed in Step 3.

**(Tightening torque 8.8 - 12.7 N · m)**

**ADVICE**

- There is a RH and a LH catch. Check the marking on the back of the part.

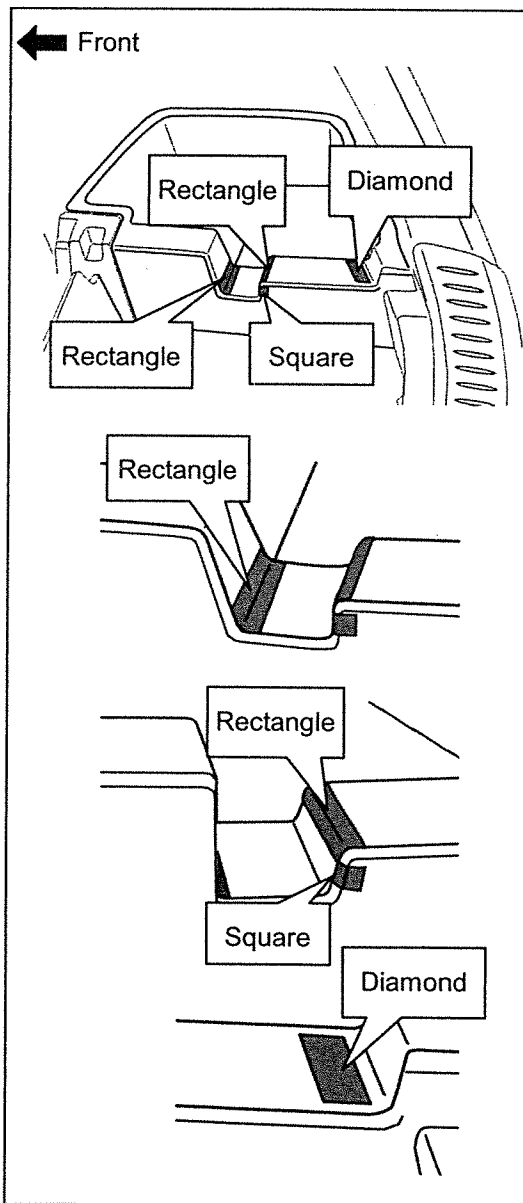

5. After degreasing the protective tape application area with isopropyl alcohol (IPA), adhere protective tape to the trunk side pocket according to the figure on the left.

## 5. INSTALLATION PROCEDURE

### Tonneau cover installation/removal

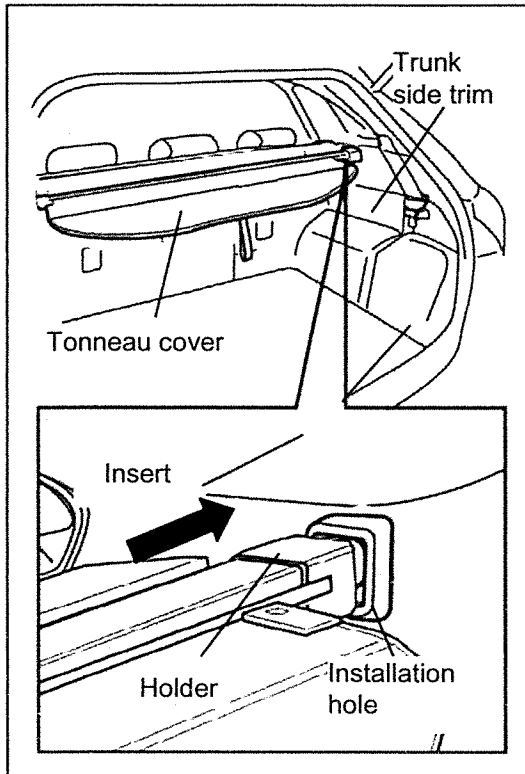

1. Fold the third-row seat forward.
2. Insert the right side holder of the tonneau cover into the trunk side trim installation hole.

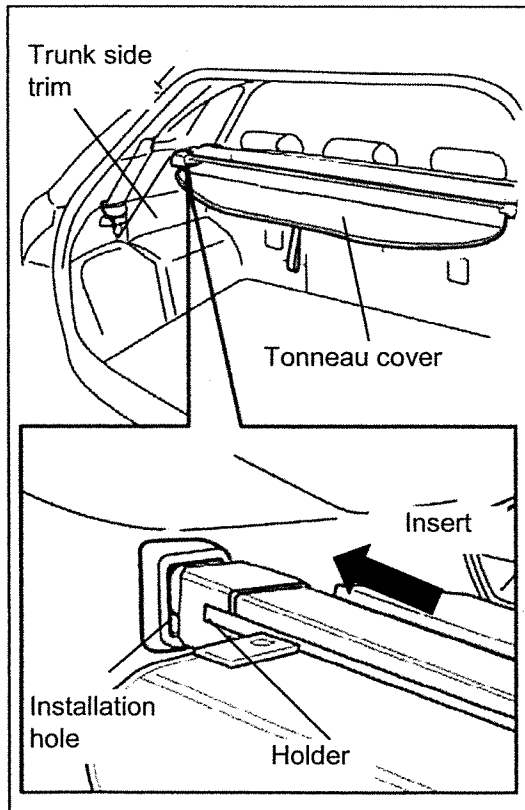

3. Insert the left side holder of the tonneau cover into the trunk side trim installation hole.

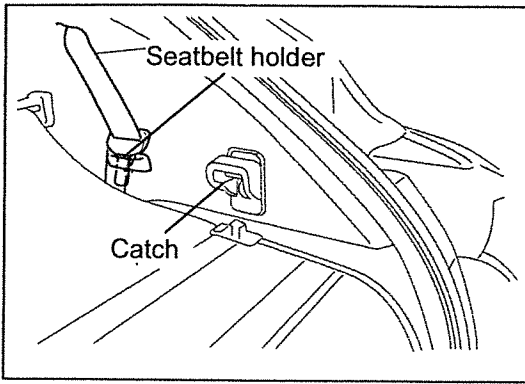

4. Insert the third-row seatbelt into the seatbelt holder. Pull the cover out slowly so that it does not get caught on the seatbelt and insert it into the catches.

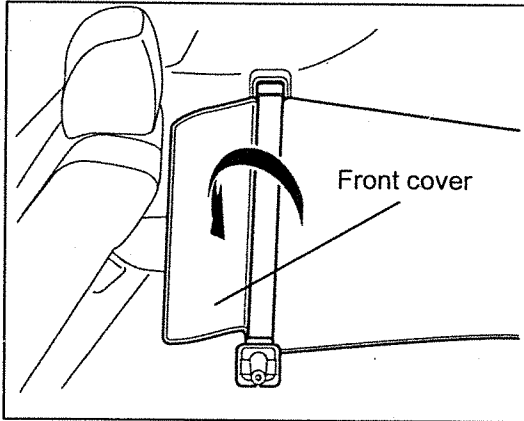

5. Fold down the front cover. Remove in the reverse order of the installation procedure.

**⚠ WARNING**

- Do not place any objects on the tonneau cover. Driving the vehicle with objects on the tonneau cover is dangerous. The objects may move when braking suddenly and cause an unexpected accident.

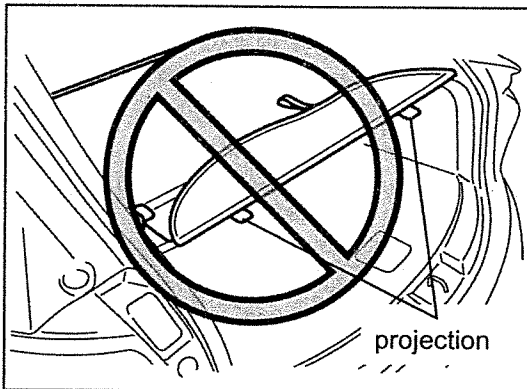

**⚠ CAUTION**

- Verify that the tonneau cover is securely fastened. If the tonneau cover is used without it being securely fastened, it may unfasten while the vehicle is being driven and cause injury.
- Do not use the tonneau cover folded up as shown in the figure on the left. The projections on the tonneau cover may cause injury to the head.

## 6. USER'S INSTRUCTION PROCEDURE

### Tonneau cover retracting/pulling out

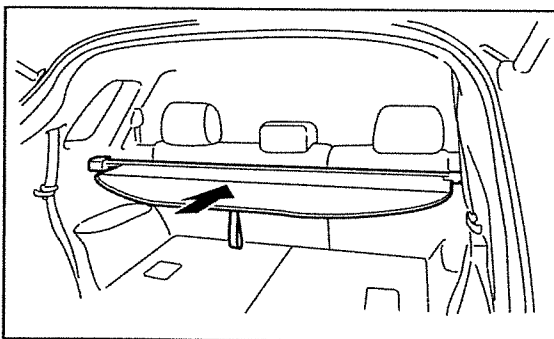

**[ Retracting the tonneau cover ]**

Remove the cover from the catches, retract the cover slowly into the case so that it does not get caught on the seatbelt, then secure it into the tonneau cover body. The cover can be kept secured as shown in the figure.

**⚠ CAUTION**

- Do not release the cover while it is being retracted as it could cause damage.

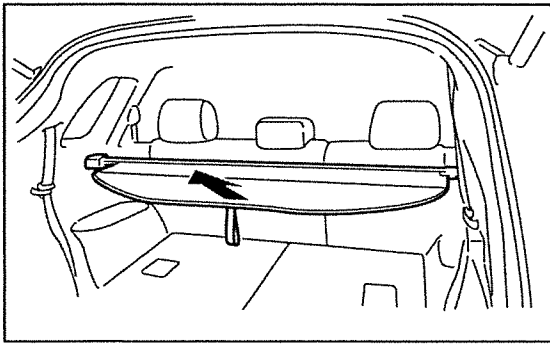

**【 Pulling out the cover 】**

Insert the third-row seatbelt in the the seatbelt holder.  
When pulling out the cover, slightly pull it up diagonally. Slowly pull out the cover so that it does not get caught on the seatbelt and insert it into the catches.

**⚠ CAUTION**

- The cover cannot be pulled down diagonally from the tonneau cover body.
- Verify that the tonneau cover is securely fastened. If the tonneau cover is used without it being securely fastened, it may unfasten while the vehicle is being driven and cause injury.

**Tonneau cover storage method**

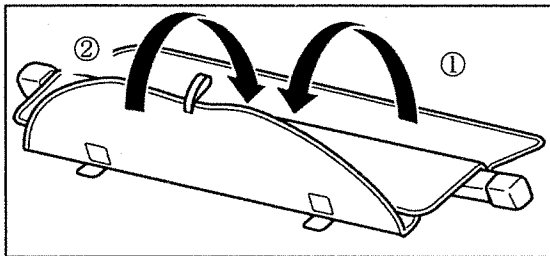

1. Remove the tonneau cover and then fold it as shown in the figure.

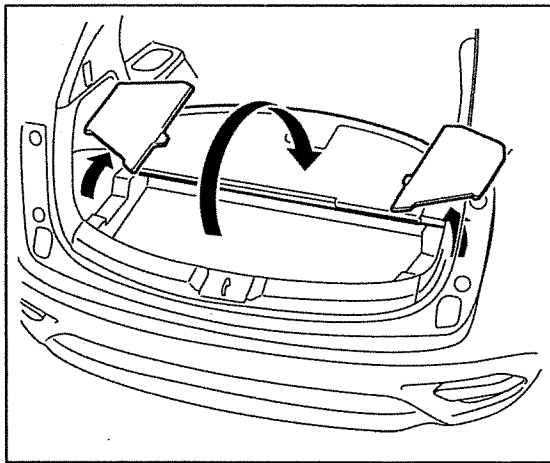

2. Fold the center of the trunk board forward, and then remove the left and right sides of the trunk board.

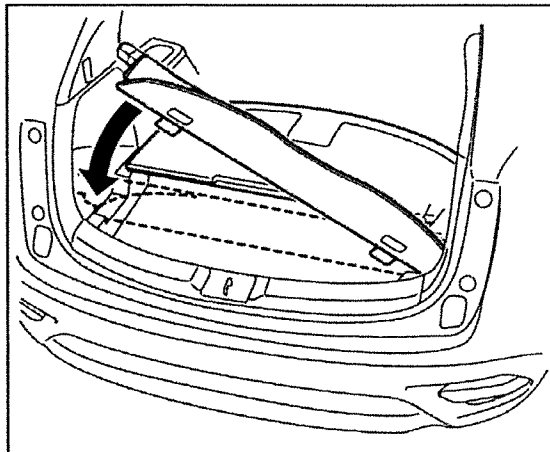

3. Place the right side of the folded tonneau cover down diagonally, and then lower it in the direction of the arrow and store it on the trunk floor at the position shown in the figure.

**ADVICE**

- The tonneau cover cannot be stored on the trunk floor at any position other than the position shown in the figure.

4. Place the trunk board back to its original position.

**ADVICE**

- When storing the tonneau cover, always store it correctly and do not leave it tilted or upright.