

GENUINE ACRYLIC VISOR

INSTALLATION AND USER'S INSTRUCTIONS

Thank you for purchasing a Genuine Mazda accessory.
 Before removal and installation, Please thoroughly read these instructions.
 For your safety, please read the contents of this booklet to properly install and use the acrylic visor.
 Keep these instructions with your vehicle records for future reference.

⚠ WARNING

- There are several ⚠ **WARNING** and ⚠ **CAUTION** sections in this booklet concerning safety when installing or removing the acrylic visor. Always read and follow the instructions in order to prevent injuries, accidents, and possible damage to the vehicle.
 - ⚠ **WARNING** : Indicates a situation in which serious injury or death could result if the warning is ignored.
 - ⚠ **CAUTION** : Indicates a situation in which bodily injury or damage to the vehicle could result if the caution is ignored.
- For areas indicating the tightening torque in the instruction manual, tighten to the specified torque by using a torque wrench. For areas in which the tightening torque is indicated inside parentheses (), the tightening torque is indicated as a reference value, however tightening using a torque wrench is not necessary.
- Do not modify the acrylic visor.
- Do not install the acrylic visor in any way other than described in the following instructions.
- If in doubt, please contact your Mazda dealer to install the accessory in order to prevent errors in installation.
- If you have any questions about the use of the accessory, ask your Mazda dealer for proper advice before using it.
- Mazda and its suppliers are not responsible for injuries, accidents, and damage to persons and property that arise from the failure of the dealer or installer to follow these instructions.
- To ensure safety and reliability of the work, installation, removal and disposal work must be carried out by an Authorized Mazda Dealership.
- Be careful not to lose removed parts, and be sure that they are kept free from scratches, grease or other dirt.

PART NAME: ACRYLIC VISOR
PART NUMBER: KB7W V3 700
VEHICLE: MAZDA CX-5

NOTE

To the dealer

- Please turn over these instructions to the customer after installation.

To the customer

- Keep these instructions after installation. The instructions may be necessary for installing other optional parts or removal of this accessory.
- Should the vehicle or this accessory be resold, Always transfer these instructions to the next owner.

1. INSTALLATION VIEW

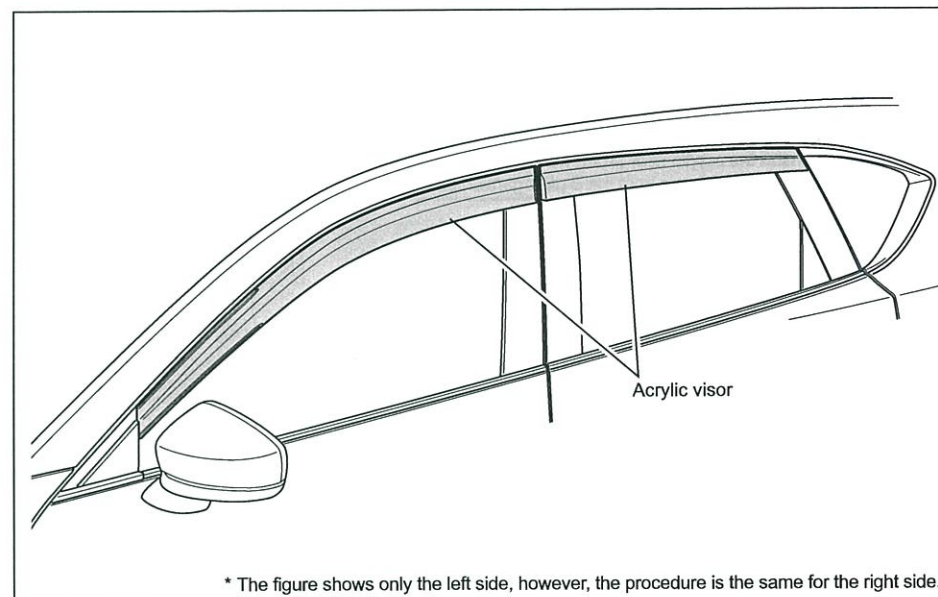

2. PARTS

- Verify that the kit includes all the following parts and that they are free of dirt, scratches, or damage.

PART	PART NAME	Qty	PART	PART NAME	Qty
	Acrylic visor (Front RH)	1		Acrylic visor (Front LH)	1
	Acrylic visor (Rear RH)	1		Acrylic visor (Rear LH)	1
	Foam sealer	1		Installation and user's instructions	1

3. BEFORE INSTALLATION

1. REQUIRED TOOLS ☆ Hair dryer (Use when the temperature is low.)

⚠ WARNING

Park the vehicle on a flat, level surface, apply the parking brake and block the wheels so that the vehicle does not move during installation.

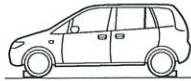

⚠ CAUTION

Kit parts and removed parts, please put on the protective sheet to prevent scratching.

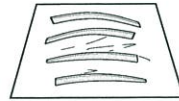

4. Application of double-sided adhesive tape

* Parts for installation indicate doors and bumpers where the acrylic visors are to be installed and the installation parts indicate new acrylic visors to replace old ones.

1. Avoid work in conditions where the temperature is 15°C or lower.

Adhesive strength is determined by the adhesive viscosity and resin softness. The lower the atmospheric temperature (15°C or lower), the lower the adhesive viscosity and weaker the adhesive strength. For this reason, avoid work in conditions where temperatures are 15°C or lower. When working under this condition is inevitable, warm both the parts for installation and the installation parts.

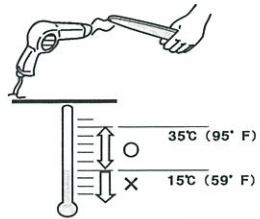

2. Press the adhesive tape evenly

Press the adhesive tape to the parts for installation evenly to maintain sufficient adhesive strength. Areas at the ends of the adhesive tape and curved surfaces of the parts for installation require particular attention.

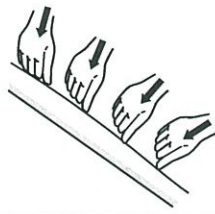

3. Keep surface of parts for installation clean

If dirt, dust, or oil are present on the surface of the parts for installation, the adhesive strength of the adhesive tape will be diminished. Wipe clean any dirt, dust or oil from the surface of the parts for installation beforehand. Clean interior parts with neutral detergent and exterior parts with IPA (isopropyl alcohol).

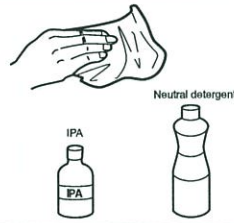

4. Keep adhesive tape surface clean.

Do not touch the adhesive tape surface with hands. This will cause oil from the skin to be transferred to the adhesive tape, diminishing the adhesive strength of the tape. Touching the adhesive tape surface with work gloves should also be avoided since this may transfer dust or dirt particles to the surface of the adhesive tape.



5. Post-installation handling

Leave the vehicle for 24 hours after work is completed to allow the tape to sufficiently adhere to the parts. Do not drive or wash the vehicle during this period. Also, do not leave vehicle outside if it is raining. Doing so will adversely affect adhesive strength of the adhesive tape. The adhesive force will greatly deteriorate if the installed acrylic visors are removed and re-installed and therefore must be avoided.



5. PREPARATION FOR ACRYLIC VISOR INSTALLATION

• The figure shows only the left side, however, the procedure is the same for the right side.

Installation surface cleaning

1. Roll down all the front and rear door glasses.
2. Degrease, clean (with IPA), and completely dry the sash molding and the B,C pillar garnish (shaded areas in figure) before installing the acrylic visors.
3. Attach the left side foam sealer along the C pillar garnish shape. (See the figure for the pasting position)

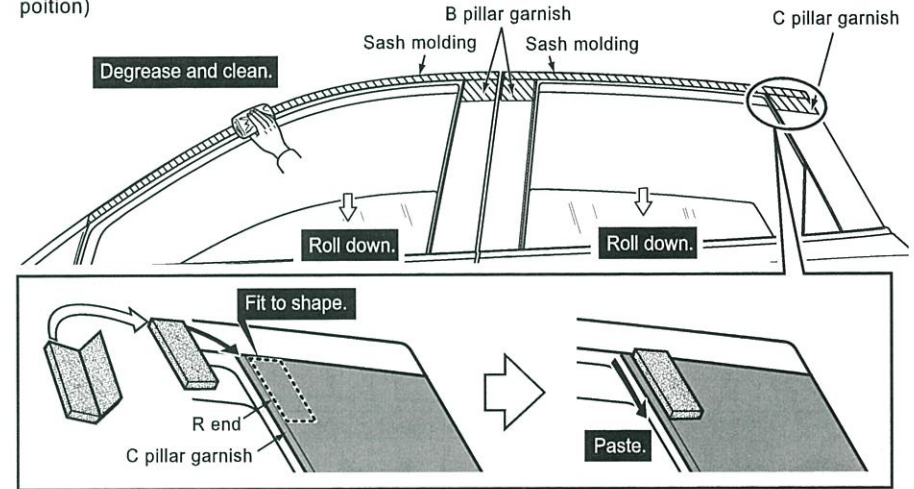

Before installation

1. Peel the adhesive tape backing 20-30mm as shown in the figure below and fold them outward.
2. Rear edge adhesive tape is peel off completely.

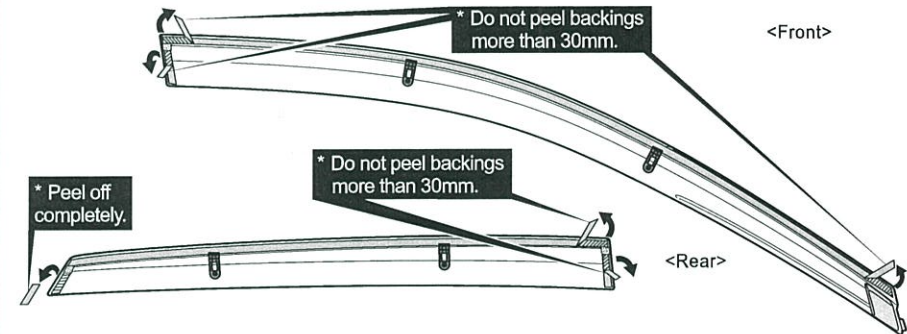

NOTE

- Do not peel the adhesive tape backings more than 30mm, as this will make it impossible to move the acrylic visors when positioning them correctly.

6. ACRYLIC VISOR TEMPORARY INSTALLATION

Acrylic visor temporary installation <Front>

1. Insert the brackets (2 places) into the sash molding with reference to the figure. (Fit the mounting bracket in the sash molding carefully so that the sash molding lip is not caught on the bracket.)
2. Insert the acrylic visor front end bracket into the Sail garnish fully until it stops. Align the upper end of the acrylic visor with the sash molding R end. (Please move while holding the bracket when moving the acrylic visor left and right.)
3. Temporarily install the acrylic visor (front) with its upper part aligned with the sash molding R end and its rear end aligned 1.0 mm – 5.0 mm from the B pillar garnish outer edge.

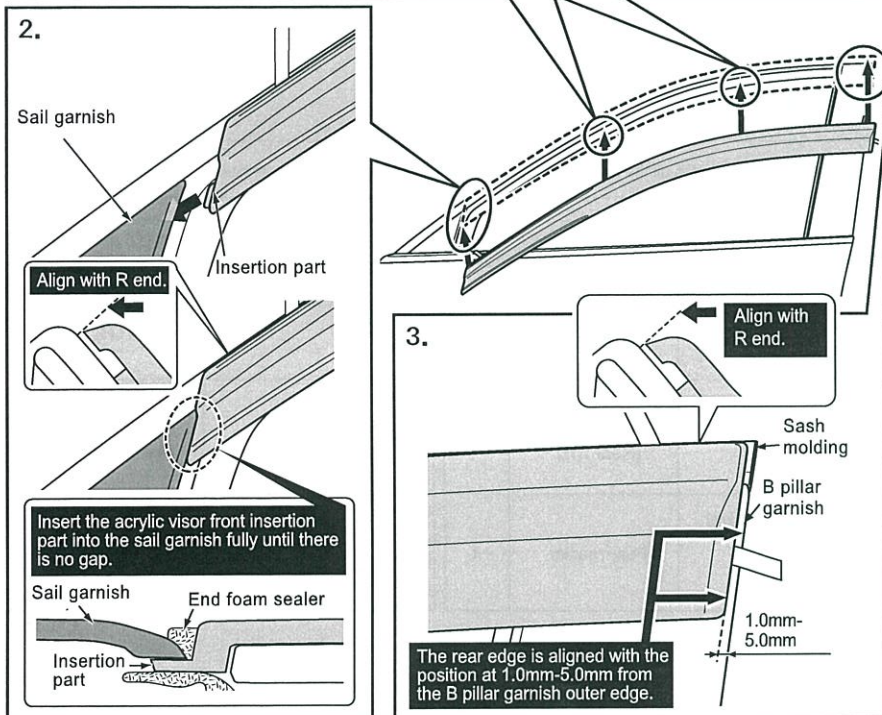
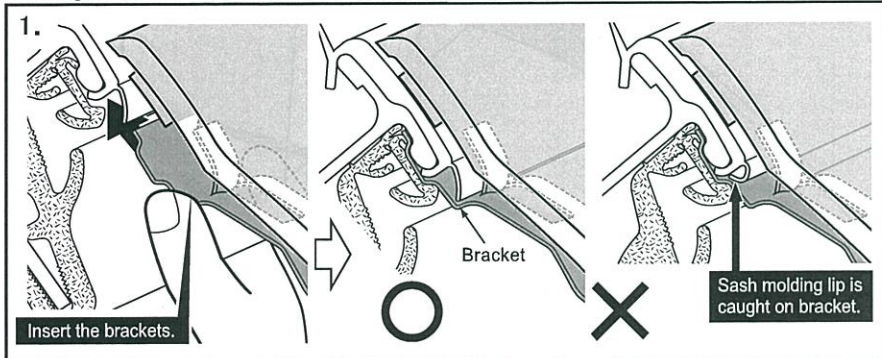

Acrylic visor temporary installation <Rear>

1. Insert the brackets (2 places) into the sash molding with reference to the figure. (Fit the mounting bracket in the sash molding carefully so that the sash molding lip is not caught on the bracket.)
2. Align the upper end of the acrylic visor rear with the sash molding R end, and then align its lower end with the rear end gap (1.0 mm to 5.0 mm) of the acrylic visor front. (Please move while holding the bracket when moving the acrylic visor left and right.)
3. Align the upper end of the acrylic visor rear with the sash molding R end, make sure that the rear end lines up with outer edge.

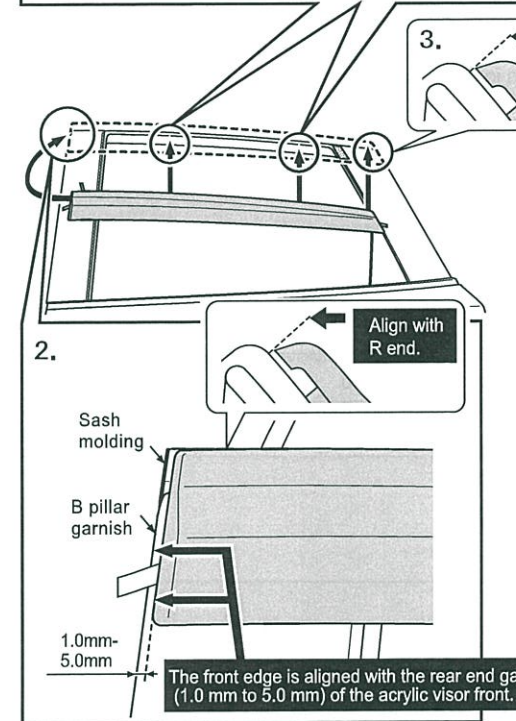
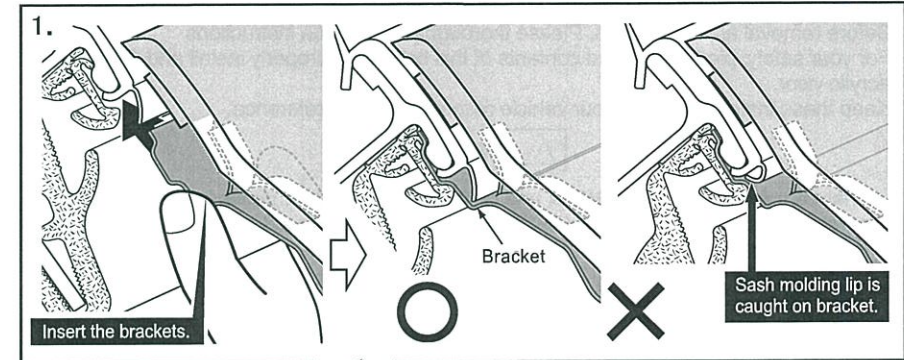

NOTE

- Confirm that the front, back, top, and bottom are evenly attached after temporary installation.

7. ACRYLIC VISOR INSTALLATION

Acrylic visor attachment

- ★ Before attaching the acrylic visors, perform the following check in the order shown.
 1. Are the acrylic visors correctly positioned with reference to the sash molding and the B,C pillar garnish?
 2. Are the brackets correctly placed?
 3. Is there no interference of the acrylic visors with the door opening or closing?

☆ If any problem is found in the above check, reposition the acrylic visors.

★ When there is no problem in the above check 1 to 3, align the acrylic visor upper parts with the sash molding R end, and remove the adhesive tape backings (a little of the tape ends should be peeled off beforehand) in direction of the arrows, being careful not to twist them. Then press down the acrylic visors evenly to completely affix them to vehicle body.

NOTE

- Press down evenly on the acrylic visors where the double-sided adhesive tapes are attached with 49N or more force applied (to the extent vehicle rocks). If adhesive strength of the  area is insufficient, this will result in partial floating and cause water seepage and wind noise.
- Adhesive strength of the double-sided adhesive tape will deteriorate if an installed visor is removed and re-installed again and therefore must be avoided.

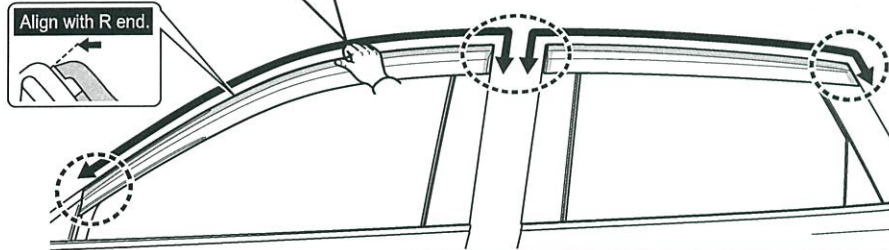
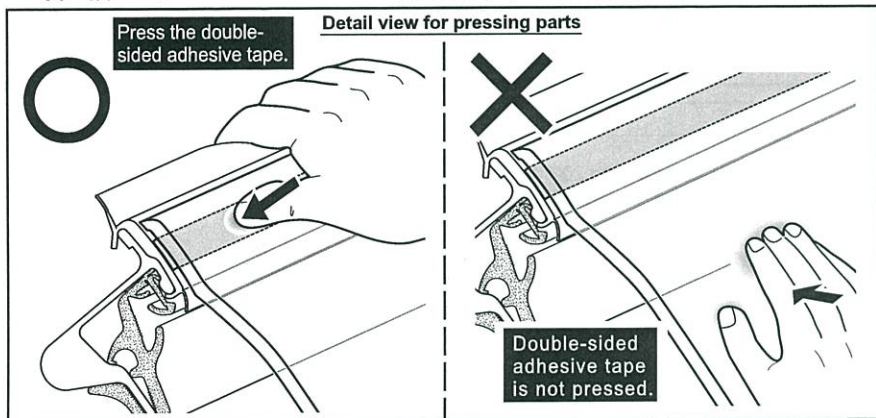
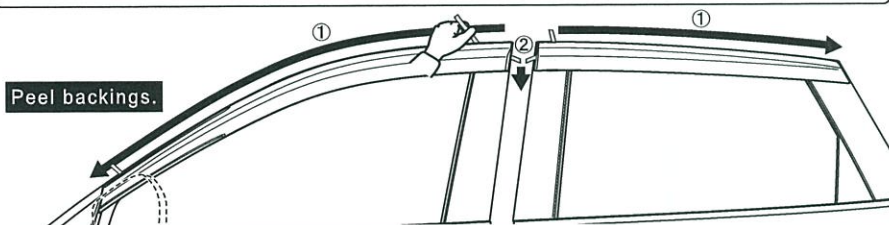

Checking the door glass channel

1. Press the door glass channel with your fingertips to conform it to the brackets.

CAUTION

- Take care to avoid being injured by the brackets when checking the parts.

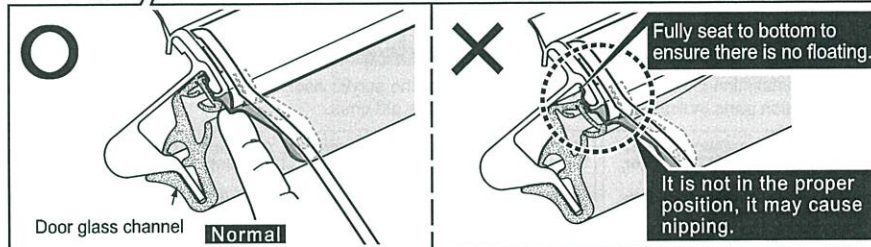
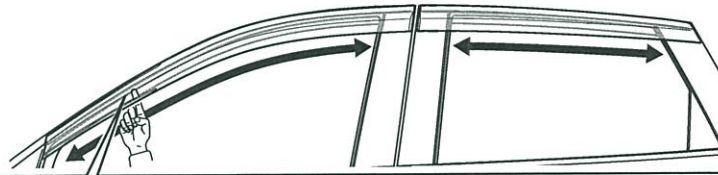

NOTE

- Always check that there is no problem in the door glass channel, otherwise the door glass operation may malfunction and/or water leakage will result.

After installation

1. Inspect all the affixing surfaces from the top and bottom to make sure that no part of the acrylic visor has lifted.
2. Lightly pull the acrylic visors to make sure that they are securely affixed.
3. Make sure that the sash molding lips are not caught on the brackets.
4. Make sure that there is no nipping of the door glass channel or noise by raising and lowering the door glass.

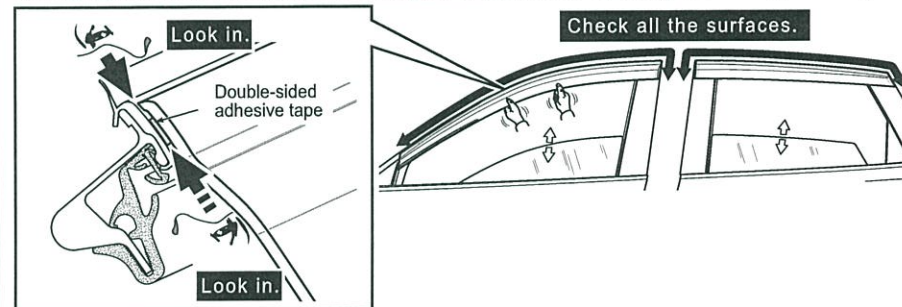

8. CAUTIONS ON HANDLING

1. If the Acrylic visors get dirty, wipe it lightly with a clean rag dampened in a neutral detergent. (Do not use thinner, benzene, gasoline or any organic solvent. It may cause deformation or discoloration to the plastic.)
2. When washing your vehicle using car wash machines or high-pressured washers, avoid excessive force to the acrylic visors to prevent them from detaching from the vehicle body.

Consult your Mazda Dealer if you have any questions regarding this accessory.