



GENUINE ACCESSORIES

INSTALLATION INSTRUCTIONS

PART NUMBER:
0000-8T-502

Scuff Plate

APPLICABLE MODELS:
2016≥ MAZDA CX-3

PACKAGE CONTENTS:



FRONT SCUFF PLATE (Qty 2)

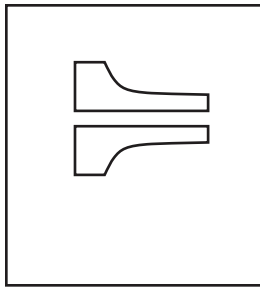

FRONT TEMPLATE SHEET



ALCOHOL WIPE (Qty 1)

TOOLS REQUIRED:



LINT FREE CLOTH

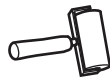

RUBBER ROLLER



MASKING TAPE



SCISSORS

⚠ CAUTION: Failure to install this part correctly could result in damage to the vehicle and/or injury to the customer. Make sure to follow the instructions properly to ensure a good installation. Read entire installation instructions before proceeding.

1. Prepare Vehicle

- A. Vehicle and scuff plate should be at 13 degree Celsius – 32 degrees Celsius (55 degrees Fahrenheit – 90 degrees Fahrenheit) for best results.
- B. Clean all dirt or other contaminants from surface.
- C. Using alcohol and cloth thoroughly clean surface to be adhered to.
- D. Allow sill area to completely air dry.

FRONT SCUFF PLATE INSTALLATION

1. Cut Templates.

A. Use scissors to cut out templates (Figure 1).

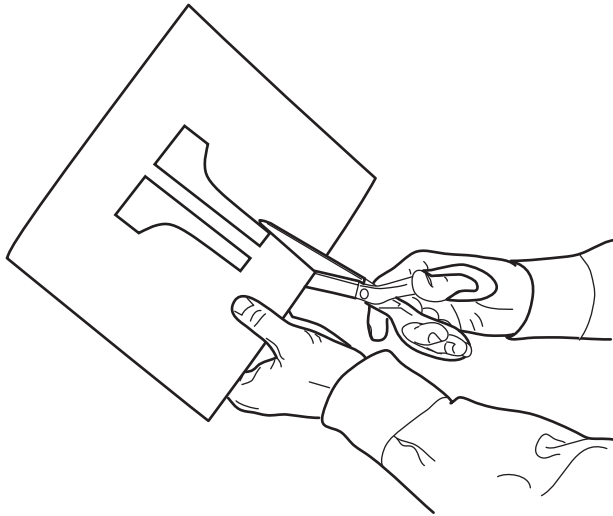

Figure 1

2. Position Template.

A. Visually align the Template with the front edge of the inner door sill trim panel.

B. Align the outer edge of the Template with the flat outer edge of the door sill (Figure 2).

C. Tape into place (Figure 3).

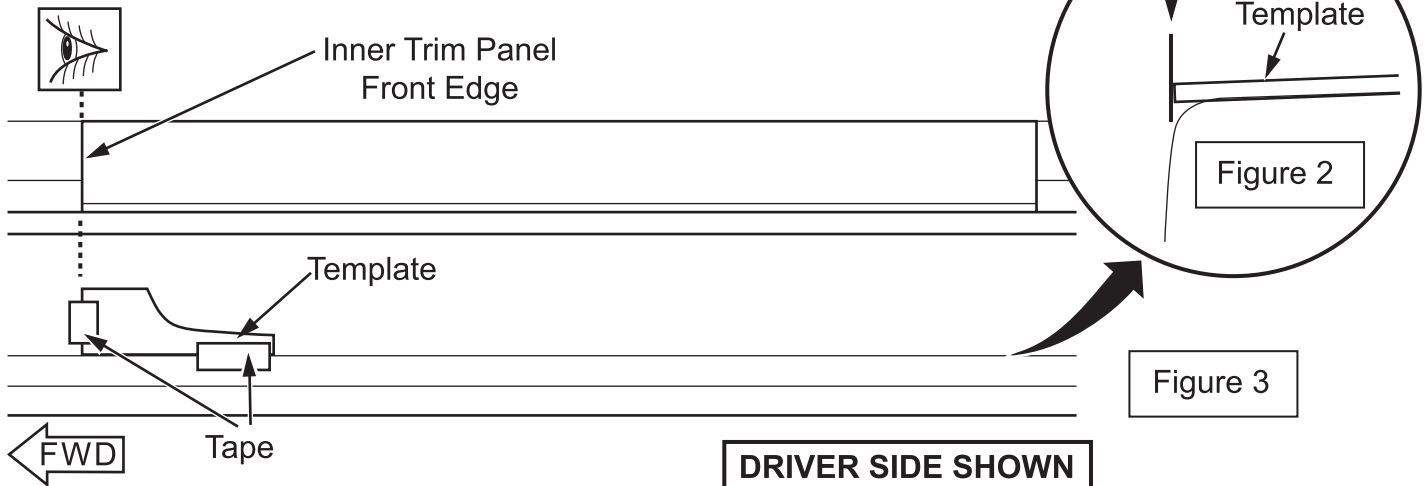

Figure 3

Figure 2

3. Scuff Plate Preparation:

A. Remove the adhesive backing from Scuff Plate and discard. (Figure 4)

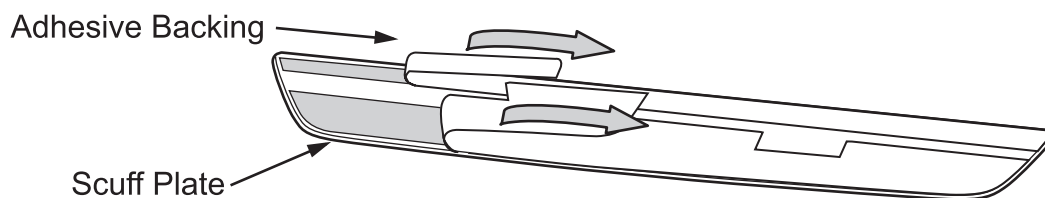

Figure 4

4. Place Scuff Plate:

- A. Carefully align Scuff Plate with the Paper Template. Push Scuff Plate inward and press down flat into position (Figure 5).
- B. Remove the Template.

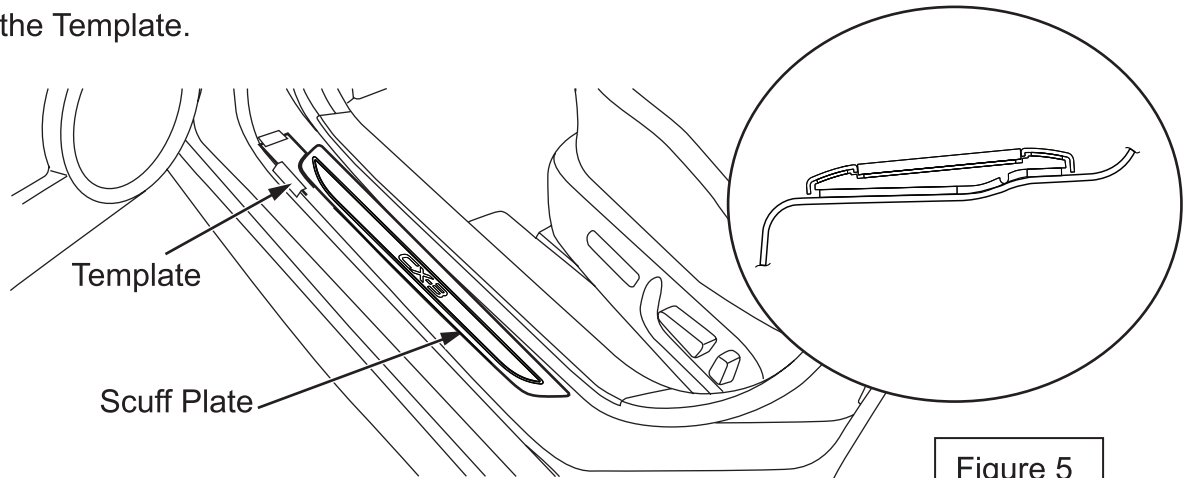

Figure 5

5. Apply Pressure to Placed Scuff Plate:

- A. Use Rubber Roller, from center out, press down the perimeter of part to ensure proper wet-out of adhesive. (Figure 6) (Use caution to ensure roller does not scratch vehicle)
- B. Wipe Clean the Scuff Plate and Sill Area of all marks and other debris.

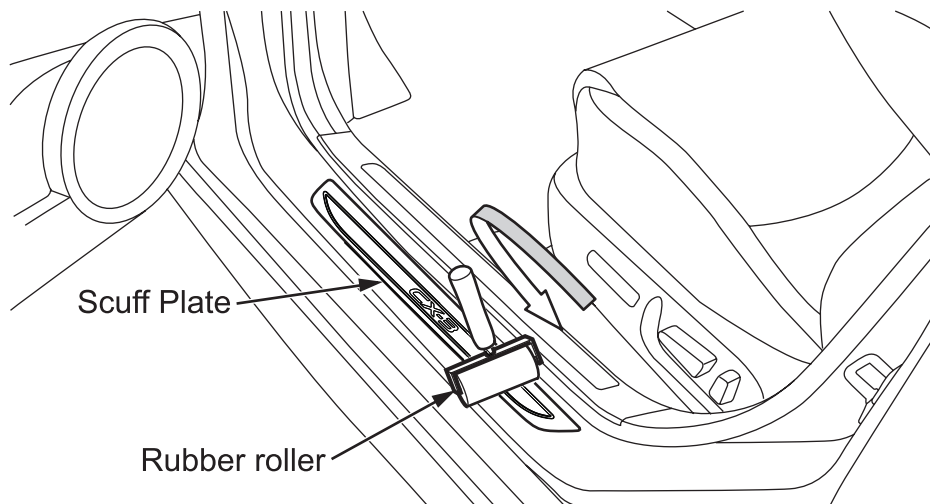

Figure 6

- 6. Inspect for proper adhesion and placement: verify the part is not loose at any corner, and that the part is located parallel to the sill panel down turn.

7. Installation of Passenger Side Scuff Plate:

- A. Repeat Previous steps for passenger side.

Installation Inspection Sheet

[To be used by installation workshop]

Mazda CX-3	Scuff Plates
	2016 ≥ , All models

Inspection items after installation
Inspect the installed parts per the items listed below.

Section to be inspected	Inspection item (circle)		
	Gap & fit	Scratches/stains	Tape residue/fingerprints
Front Scuff Plate	○	○	○

Date		(year/month/day)			
VIN No.					
Approved		Checked		Prepared	

❖ Retention period of this sheet: 12 months