

# GENUINE MUD FLAP (REAR)

## INSTALLATION AND USER'S INSTRUCTIONS



Thank you for purchasing a genuine Mazda accessory.

Before removal and installation, be sure to thoroughly read these instructions.

Please read the contents of this booklet in order to properly install and use the mud flap (rear).

Your safety depends on it. Keep these instructions with your vehicle records for future reference.

### **WARNING**

- There are several  **WARNING** and  **CAUTION** sections in this booklet concerning safety when installing or removing the mud flap (rear). Always read and follow them in order to prevent injuries, accidents, and possible damage to the vehicle.

 **WARNING** : Indicates a situation in which serious injury or death could result if the warning is ignored.

 **CAUTION** : Indicates a situation in which bodily injury or damage to the vehicle could result if the caution is ignored.

- For areas indicating the tightening torque in this instruction manual, tighten to the specified torque using a torque wrench. For areas in which the tightening torque is indicated inside parentheses ( ), the tightening torque is indicated as a reference value, however tightening using a torque wrench is not necessary.
- Do not modify the mud flap (rear).
- Do not install the mud flap (rear) in any way other than described in the following instructions.
- If in any doubt, please ask your Mazda dealer to install the accessory in order to prevent errors in installation.
- If you have any questions about the use of the accessory, ask your Mazda dealer for proper advice before using it.
- Mazda and its suppliers are not responsible for injuries, accidents, and damage to persons and property that arise from the failure of the dealer or installer to follow these instructions.
- To ensure safety and reliability of the work, installation, removal and disposal work must be carried out by an Authorized Mazda Dealership.
- Be careful not to lose removed parts and be sure that they are kept free from scratches, grease or other dirt.

**PART NAME: MUD FLAP (REAR)**  
**PART NUMBER: B0L6 V3 460 (HATCHBACK)**  
**VEHICLE: MAZDA3**

### **NOTE**

#### **To the dealer**

- Please turn over these instructions to the customer after installation.

#### **To the customer**

- Keep these instructions after installation. The instructions may be necessary for installing other optional parts or removal of this accessory.
- Should the vehicle or this accessory be resold, always leave these instructions with it for the next owner.

## 1. INSTALLATION VIEW

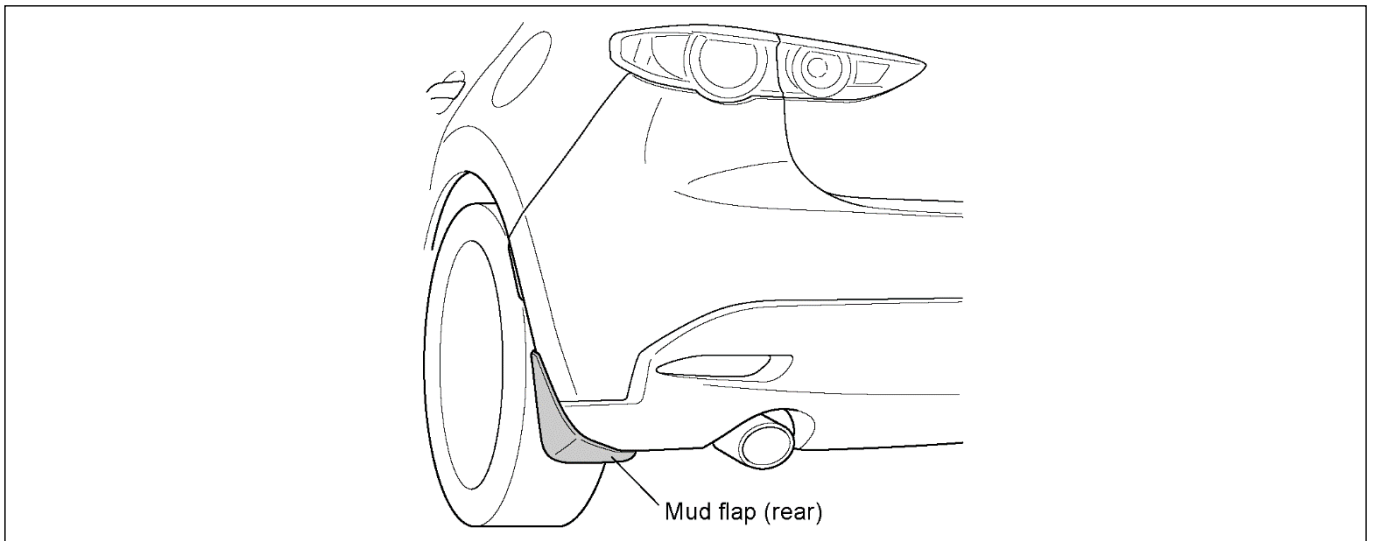

## 2. PARTS

- Before installation, verify that the kit includes all the following parts and that they are free of dirt, scratches, or damage.

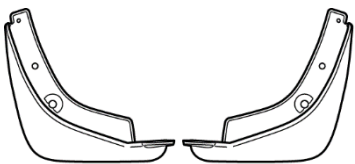
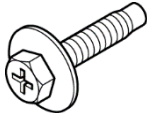
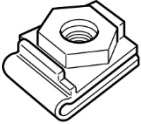
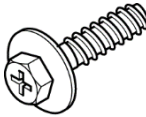
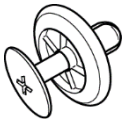
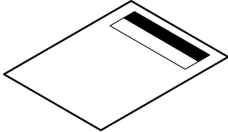
| Part  | Part name                  | Qty    | Part   | Part name                              | Qty |
|---|----------------------------|--------|--|--|-----|
|  | Mud flap (rear)<br>(RH/LH) | Each 1 |  | Bolt                                   | 4   |
|  | Clip nut                   | 4      |  | Tapping screw                          | 2   |
|  | Push turn rivet            | 2      |  | Installation and<br>user's instruction | 1   |

## 3. BEFORE INSTALLATION

### ■ REQUIRED TOOLS (Make sure they are at hand before starting work)

- ☆Nippers
- ☆Fastener remover
- ☆Scale
- ☆Phillips screwdriver
- ☆Scriber
- ☆Torque wrench
- ☆Socket wrench (8mm)

### ⚠ WARNING

Before performing any work, park the vehicle on level ground, apply the parking brake securely, and then block the wheels. If the vehicle moves while performing work, it may cause injury.

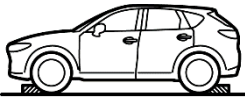

### ⚠ CAUTION

|   |  |   |  |
|---|--|---|--|
| <p>Be sure to cover the vehicle body with protectors or mats when removing/installing parts. Otherwise, the vehicle may be scratched or become dirty.</p> | <p>Using improper tools may cause damage and or broken parts. Use the correct tool for the installation.</p>   | <p>Wrap protective tape around screwdrivers and fastener remover tools to prevent scratching the vehicle.</p> | <p>Place the removed parts and kit accessories on a protective sheet to prevent scratches.</p> |
|   |  |   |  |
| <p>[Drilling]<br/>When drilling holes, be sure to wrap the drill bit with gum tape or similar to prevent drilling from going too deep.</p>                | <p>[Drilling]<br/>When drilling holes, hold the drill bit or hole saw so that it is perpendicular to the drilling surface so that the position of the hole being drilled does not shift.</p> | <p>[Drilling]<br/>After drilling holes, file away any rough edges and burrs until the edges are smooth.</p>   |  |
|   |  |   |  |

### Advice

Refer to the Workshop Manual for removal and installation of applicable vehicle parts.



## 4. MUD FLAP (REAR) INSTALLATION

- The diagrams showing the work procedure are for the left side of the vehicle; the same steps should be carried out for the right side as well.

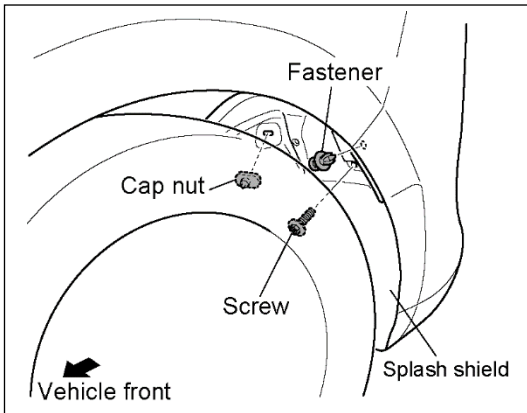

- Remove the splash shield fastener and the cap nut (1 place each) and the screw (1 place).

- The removed fastener, cap nut and screw will be reused.

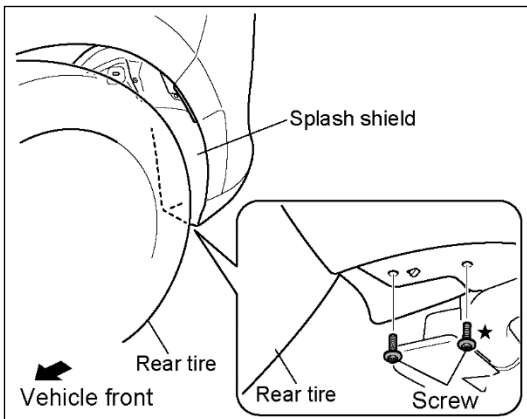

- Remove the screws at the bottom of the splash shield (2 places), and then remove the splash shield.

- The removed screws (★: 1 place) will be reused.

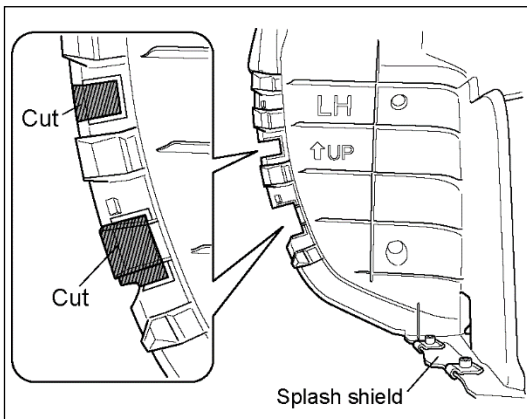

- Use a nipper or similar to cut the splash shield along the notch lines on the underside of the splash shield. (2 place)

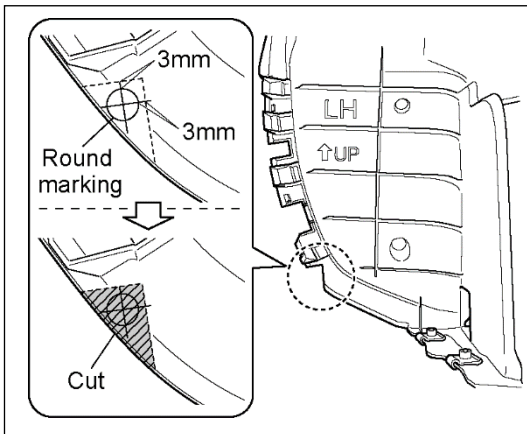

- Make additional marking lines about 3 mm away from the round marking on the splash shield.
- Use a nipper or similar to cut the splash shield along the marking lines.

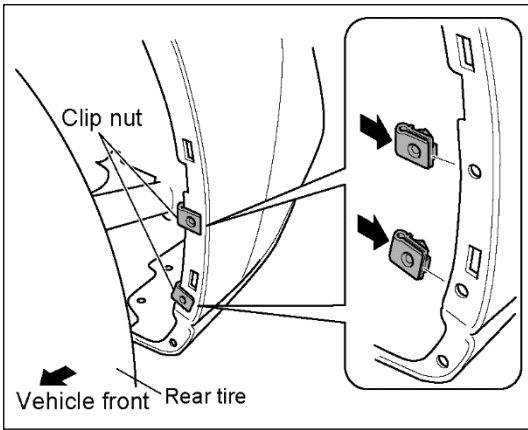

6. Install the clip nuts to the rear bumper (2 places).

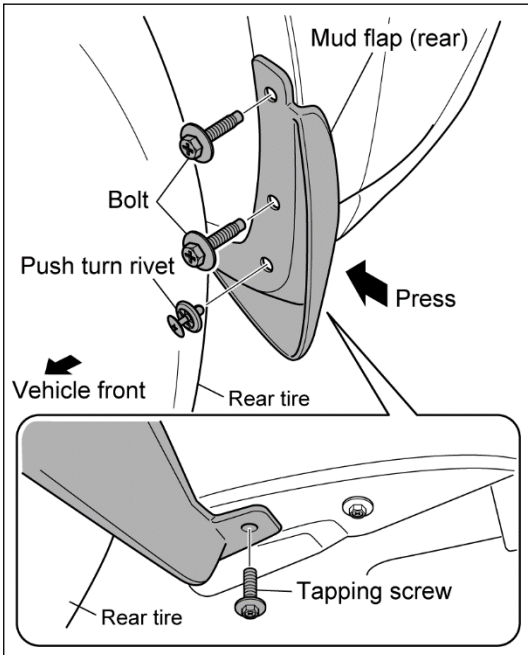

7. Replace the splash shield on the vehicle by following the removal procedure in section 1 in reverse.

- Install the bottom of the splash shield using the screw (★: reuse).

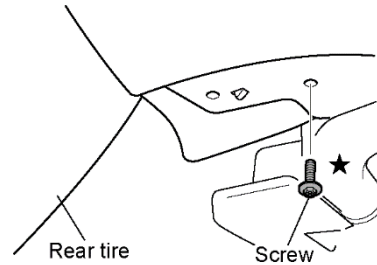

8. Place the mud flap (rear) against the vehicle as shown in the diagram at left, and then while pressing it so that there are no gaps, install it by using the bolts (2 places), the tapping screw (1 place) and the push turn rivet (1 place).

**Bolt tightening torque: (0.8-1.2 N·m)**

## 5. INSPECTION AFTER INSTALLATION

1. Check that there are no gaps.

- If there are any gaps, loosen the bottom tapping screw, and then re-tighten it while pressing the mud flap (rear) against the vehicle.

2. Check that the bolts and tapping screw are securely tightened.

## 6. TO THE CUSTOMER

Be sure to observe the following when handling (cleaning) the mud flaps (rear).

- If gasoline, oil, engine coolant, or battery fluid adheres to the hard plastic parts, it will cause discoloration, stains, or damage. Wipe off immediately with a soft cloth.
- Depending on the type of high pressure car washer used, the water for washing may be high temperature and/or under high pressure. Be careful when using pressurized water from a car washer nozzle. If the nozzle is too close or water pressure is applied for long periods, it may cause deformation or damage to the hard plastic parts.
- Do not use electric or air tools to apply wax or compound (polishing powder). Otherwise, friction heat will be generated causing deformation or damage to the hard plastic parts.
- If the vehicle height is lowered due to the vehicle being at the maximum passenger or cargo capacity described in the vehicle inspection certificate, decrease the vehicle speed when parking on a road shoulder or entering/leaving a road shoulder or bump. The mud flaps (rear) may get in the way and become damaged.