

# GENUINE LIFTGATE GARNISH

## INSTALLATION INSTRUCTIONS



Thank you for purchasing a Genuine Mazda Accessory.

Before installation, **please thoroughly read these instructions.**

For your safety, please read the contents of this booklet to properly install and care for the Liftgate Garnish.

Keep these instructions with your vehicle records for future reference.



There are several  **WARNING** and  **CAUTION** sections in this booklet concerning safety when installing the Puddle Light. Always read and follow them in order to prevent injuries, accidents, and possible damage to the vehicle.

 **WARNING:** Indicates a situation in which serious injury or death could result if the warning is ignored.

 **CAUTION:** Indicates a situation in which bodily injury or damage to the vehicle could result if the caution is ignored.

- Do not modify the Liftgate Garnish.
- Do not install the Liftgate Garnish in any way other than described in the following instructions.
- If in any doubt, please ask your Mazda dealer to install the accessory in order to prevent errors in installation.
- If you have any questions about the use of the accessory, ask your Mazda dealer for proper advice before using it.
- Mazda and its suppliers are not responsible for injuries, accidents, and damage to persons and property that arise from the failure of the dealer or installer to follow these instructions.
- To ensure safety and reliability of the work, installation, removal and disposal work must be carried out by an Authorized Mazda Dealership.

PART NAME: Liftgate Garnish

PART NUMBER: K MV6 V3 090 , KR9D V3 090



## 1. PARTS

Verify that this kit includes the Liftgate Garnish in good condition with no damage. The protective liner on the adhesive tape should be completely intact when starting this installation.

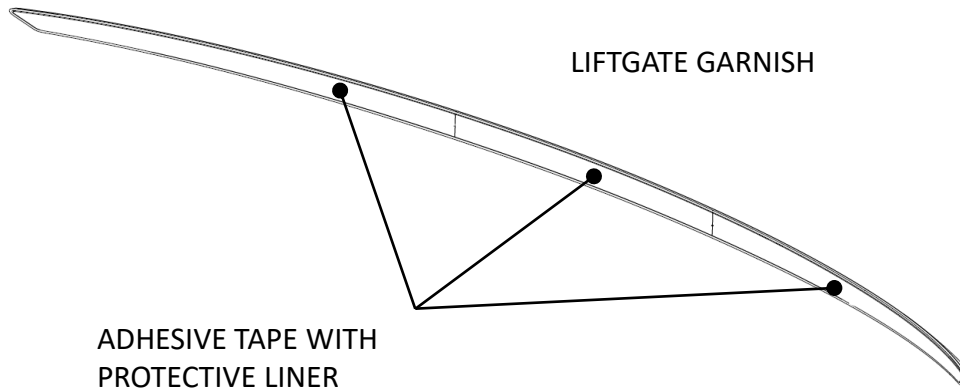

## 2. INSTALLATION VIEW

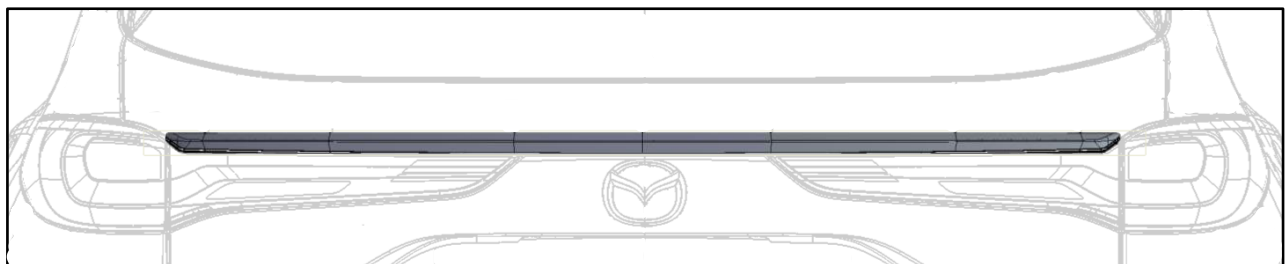
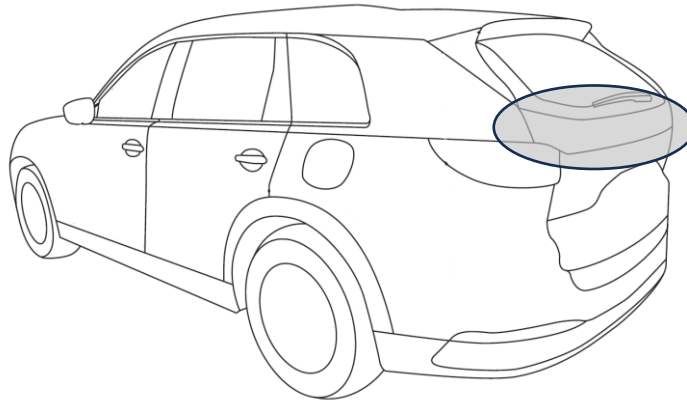

# 3. BEFORE INSTALLATION



## REQUIRED TOOLS

- ☆ Eye protection
- ☆ IPA (Isopropyl alcohol)
- ☆ Masking Tape
- ☆ Scissors
- ☆ Clean Towel
- ☆ Soft Lint Free Cloth



## OTHER PREPERATIONS

- To perform the installation work safely and maintain functionality and quality, thoroughly read these instructions before performing the procedures and always heed the warnings and precautions.
- In the work procedures, there are descriptions which are only indicated in the figure. Make sure to follow these procedures as well.

### ⚠ WARNING

|   |   |
|---|---|
| <p>Before performing any work, park the vehicle on level ground, apply the parking brake securely, and then block the wheels.</p> | <p>Be careful when handling scissors and other sharp objects. If not handled properly, it could result in serious injury.</p> |
|    |    |

### ⚠ CAUTION

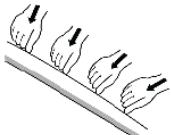
|   |  |   |
|---|--|---|
| <p>If there is dust, dirt or grease on the adhesion surface, the adhesive strength of the double-sided adhesive tape will splotch and adhesive power of the tape will be reduced. Wash and degrease the surface of the adhesion area before applying the double-sided adhesive tape. Be sure to wash interior and exterior parts using IPA (isopropyl alcohol).</p> | <p>If tape or a mount base is re-adhered, the adhesive strength will be weakened. Before adhering, accurately determine the adhesion position.</p> | <p>To assure sufficient adhesion of the tape, firmly press the part onto the vehicle. Be sure to use even pressure along the entire length of the part so that every section of tape achieves good contact. Begin pressing from the center of the part outward to the tips.</p> |
|    |   |    |

## 4. PREPERATION

### BEFORE INSTALLATION:

- Read the entire Installation Instruction before proceeding.
- Cut out the Installation Templates, carefully following the perimeter line. (Installation Templates are located on the last page of this document)
- Vehicle application surface must be at minimum 50° F (15 ° C) before applying garnish.
- Have IPA ready to clean the vehicle surface.

### CLEAN VEHICLE SURFACE:

1. Use IPA and a towel to clean the vehicle surface in the location shown below.
2. Wait for surface to dry before proceeding to Garnish Installation.

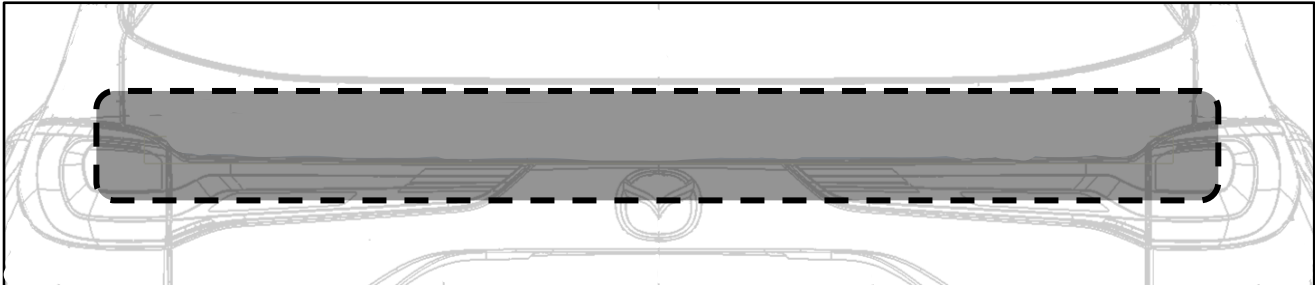

## POSITION ALIGNMENT TEMPLATES

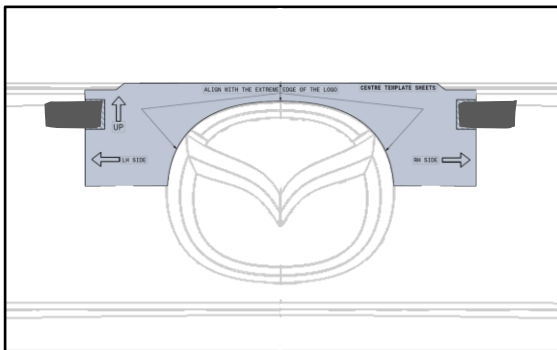
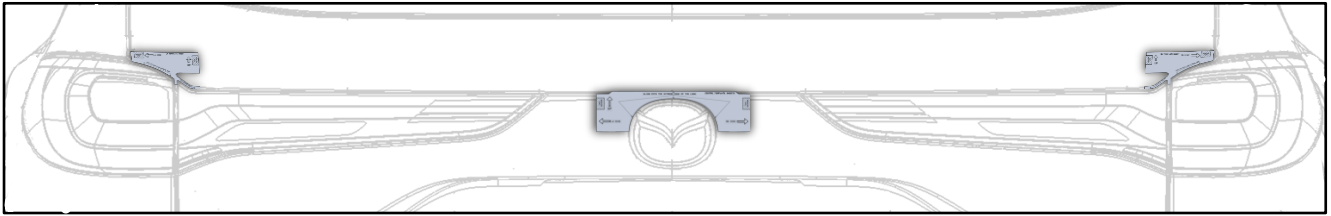

3. Position the **Center** template onto the liftgate.
4. Carefully align the bottom curved edge to the top of the Mazda logo, and align the top edge parallel to the panel gap.
5. Smooth the template against the vehicle making sure there are no wrinkles.
6. Tape into place as indicated on the template.

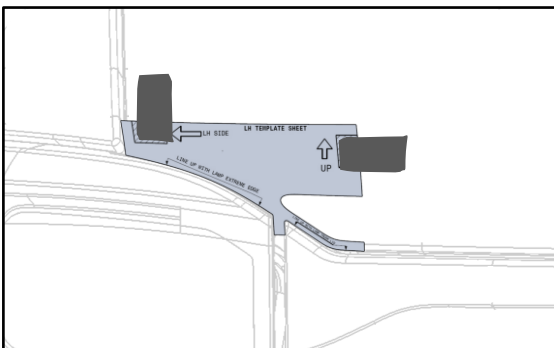

7. Position the **Left Hand and Right Hand** templates onto the liftgate.
8. Carefully align the templates to the top edge of the taillights, and to the gaps between the lights.
9. Smooth the templates against the vehicle making sure there are no wrinkles.
10. Tape into place as indicated on the templates.

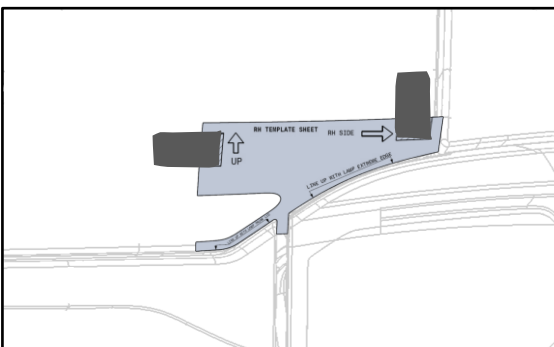

## PREPARE FOR GARNISH PLACEMENT

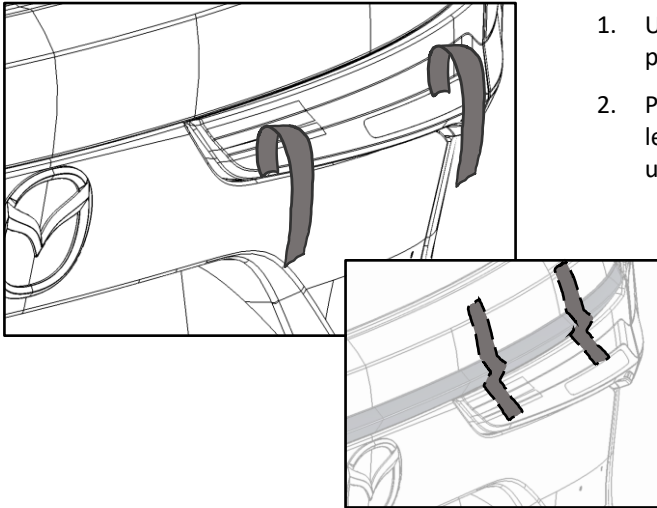

1. Use masking tape to temporarily secure the garnish in place before its final adhesion.
2. Place 4 (four) pieces of tape on the taillights as shown and leave them hanging. Ensure tape is long enough to reach up and over the installed garnish.

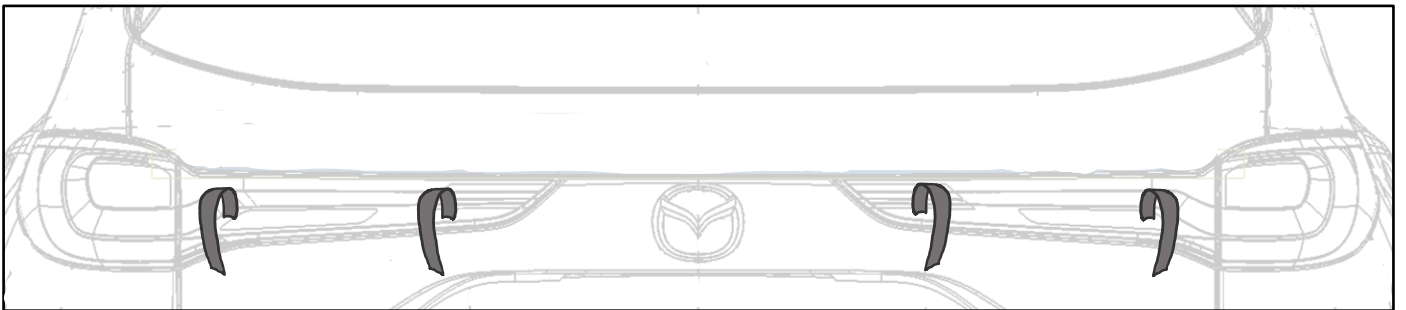

## 5. INSTALLATION

### PREPARE THE TAPE LINER

1. Peel a small portion of the tape liner on each piece.
2. **DO NOT** peel liner at the tips. Peel liner at the middle of the part as shown below.

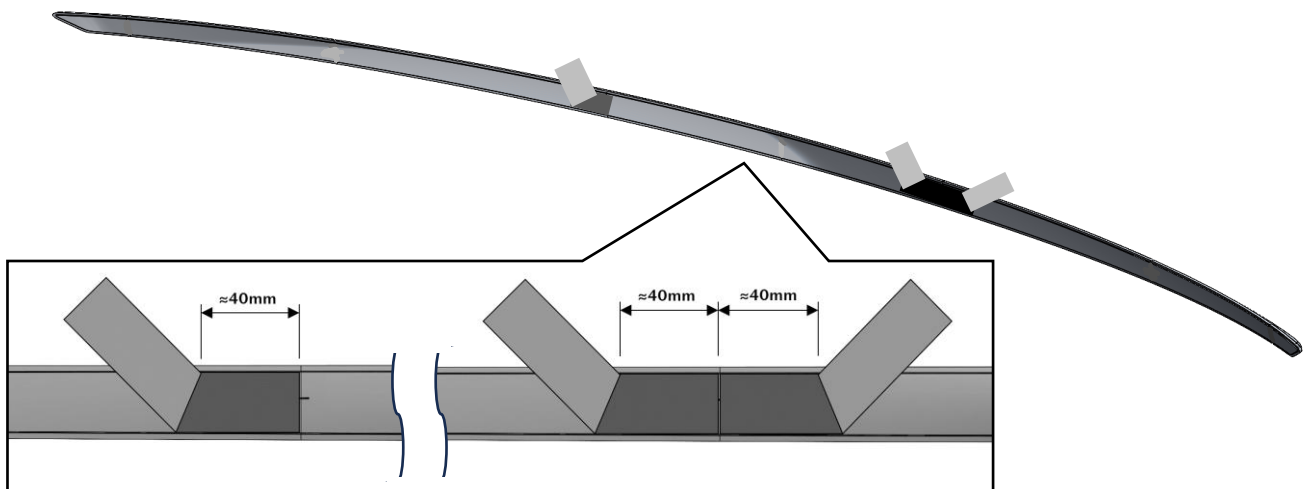

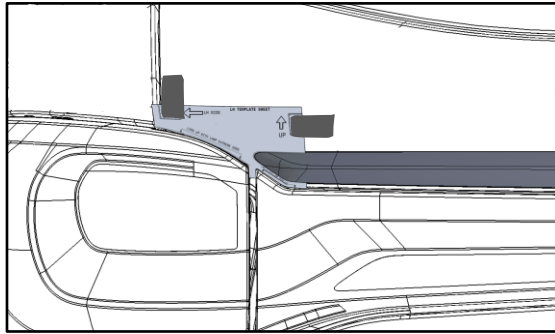

3. Place the Garnish in its location and align it with the templates.
4. Make sure the small portions of tape liner are sticking out and accessible to pull.
5. TIP TEMPLATES: Check that the garnish is centered by comparing how it fits within the left and right templates. Small horizontal adjustment of the garnish may be needed.

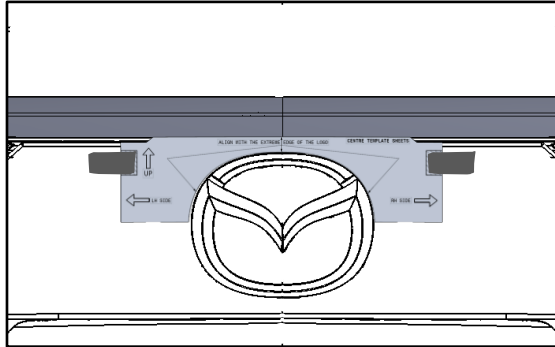

6. CENTER TEMPLATE: Align the bottom edge of the garnish with the top edge of the center template.

7. With the Garnish in position, tightly apply the four pieces of tape to keep it in place.
8. Double check that the garnish is still in alignment to with the templates.

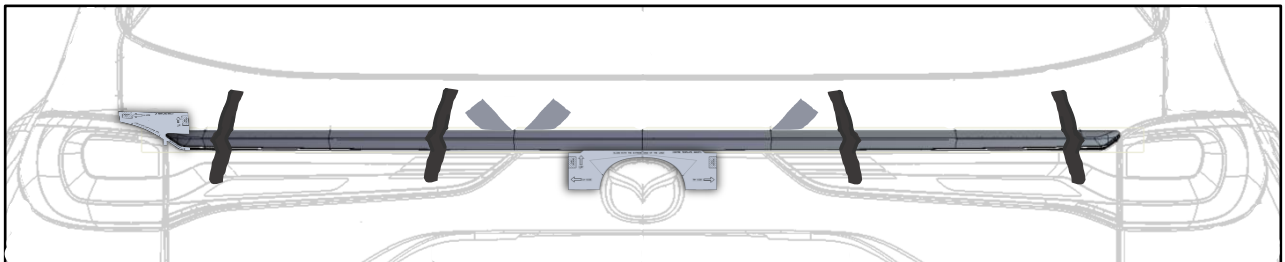

9. Pull the tape liner from the center section first, making sure to hold the garnish in position with the templates.
10. Remove the remaining two liners, making sure to hold the garnish in position with the templates. Remove the four pieces of tape as you peel the liner.

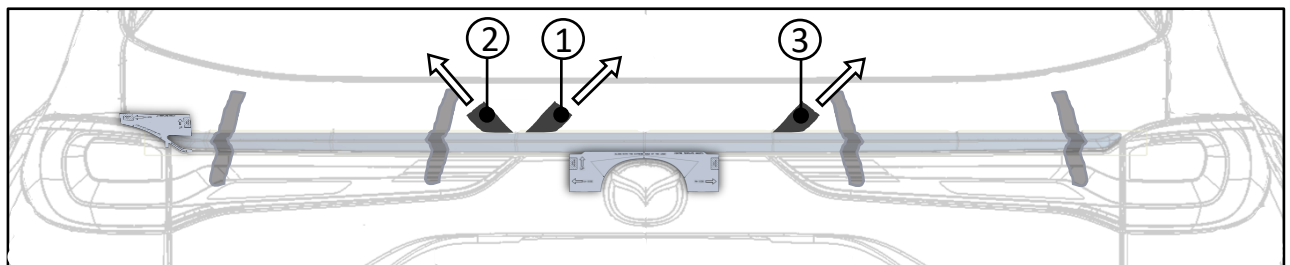

11. Remove the templates.
12. Using a Soft Lint Free Towel, press firmly on the Garnish, starting from the center and moving outward, all the way to the tips. Make sure to apply pressure along the entire length of the garnish so that every part of the adhesive tape makes solid contact with the vehicle.

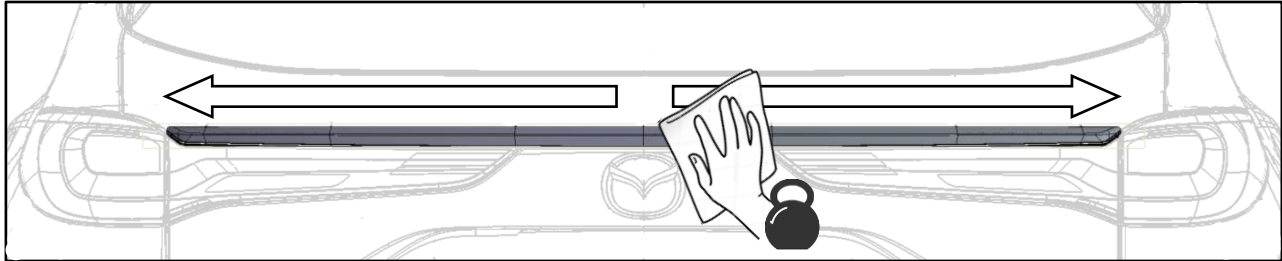

## 6. INSPECTION

| Inspection Parts | Inspection Item | Inspection   | Check |
|------------------|-----------------|--|-------|
| Liftgate Garnish | Straightness    | Check that the garnish is level and has symmetric gaps to both taillights.   |       |
|                  | Gaps            | Check that there is a consistent gap between the garnish and the liftgate surface.<br>Maximum allowable gap to vehicle is 1mm. |       |
|                  | Tape Liner      | Ensure all the tape liner has been removed and the garnish is fully adhered to the vehicle.                                    |       |
|                  | Adhesion        | Make sure to apply pressure using a towel to the entire garnish to ensure full adhesion to the vehicle.                        |       |
|                  | Appearance      | Clean off any fingerprints or dirt that may have attached to the garnish during installation.                                  |       |



## 7. PAPER INSTALLATION TEMPLATES 1:1

### ⚠ CAUTION

CAREFULLY CUT OUT THESE TEMPLATES FROM THIS PAGE.

### ⚠ PRECAUCIÓN

RECORTE CUIDADOSAMENTE ESTAS PLANTILLAS DE ESTA PÁGINA.

### ⚠ PRUDENCE

DÉCOUPEZ ATTENTIVEMENT CES MODÈLES DE CETTE PAGE.

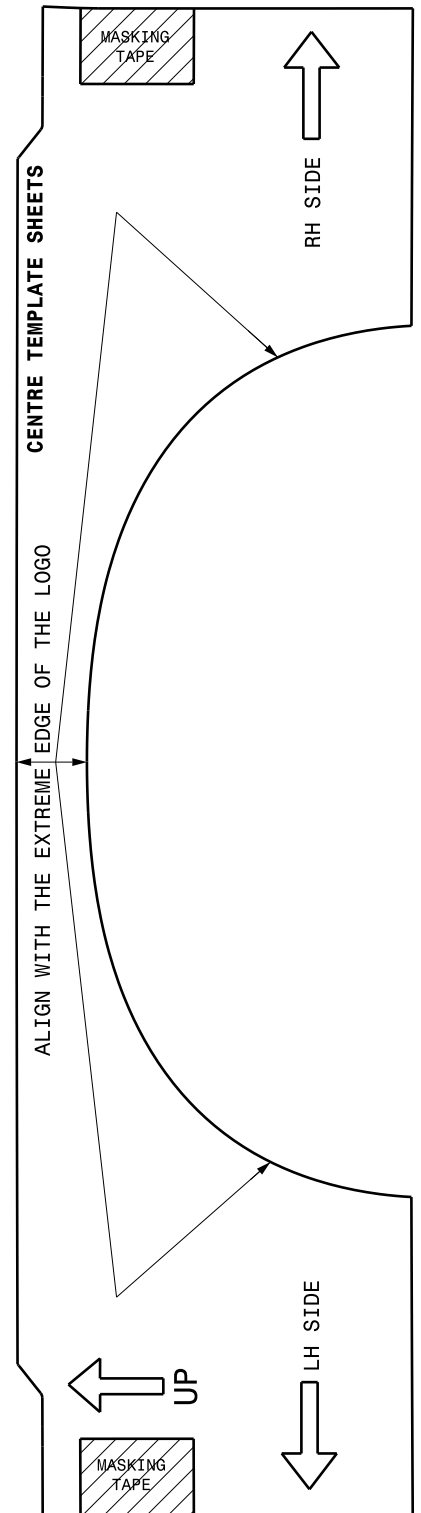
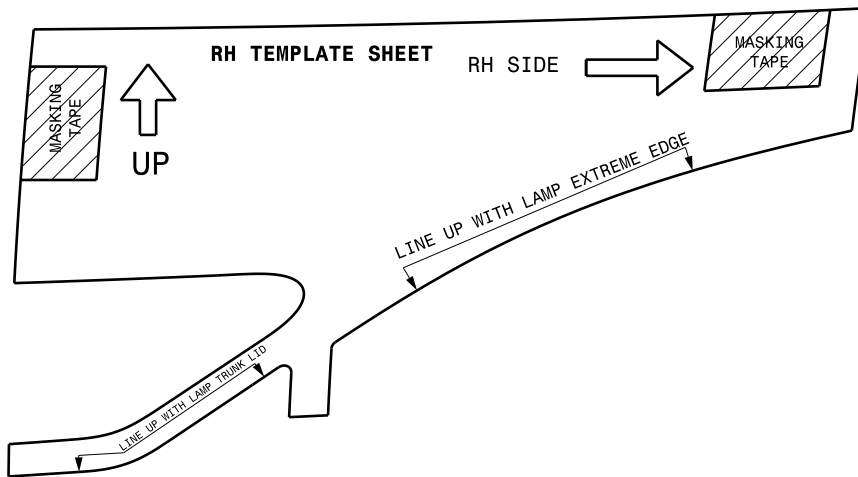
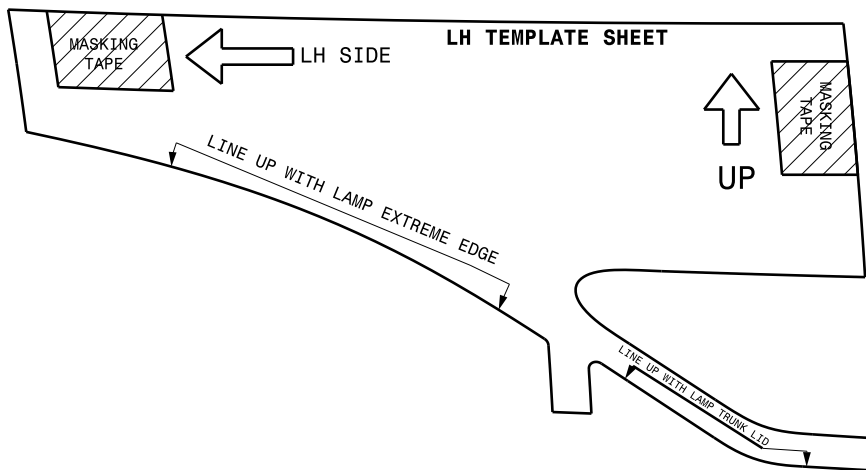

## SCALE CHECK / COMPROBACIÓN DE ESCALA / VÉRIFICATION DE LA BALANCE

