

GENUINE MUD FLAP (FRONT)

INSTALLATION INSTRUCTIONS

Thank you for purchasing a Genuine Mazda Accessory.

Before removal and installation, Please thoroughly read these instructions.

For your safety, please read the contents of this booklet to properly install and use the mud flap (front).

Keep these instructions with your vehicle records for future reference.



- There are several **⚠WARNING** and **⚠CAUTION** sections in this booklet concerning safety when installing or removing the mud flap (front). Always read and follow the instructions in order to prevent injuries, accidents, and possible damage to the vehicle.

⚠WARNING : Indicates a situation in which serious injury or death could result if the warning is ignored.

⚠CAUTION : Indicates a situation in which bodily injury or damage to the vehicle could result if the caution is ignored.

- For areas indicating the tightening torque in this instruction manual, tighten to the specified torque by using a torque wrench. For areas in which the tightening torque is indicated inside parentheses (), the tightening torque is indicated as a reference value, however tightening using a torque wrench is not necessary.
- Do not modify the mud flap (front).
- Do not install the mud flap (front) in any way other than described in the following instructions.
- If in doubt, please contact your Mazda dealer to install the accessory in order to prevent errors in installation.
- If you have any questions about the use of the accessory, ask your Mazda dealer for proper advice before using it.
- Mazda and its suppliers are not responsible for injuries, accidents, and damage to persons and property that arise from the failure of the dealer or installer to follow these instructions.
- To ensure safety and reliability of the work, installation, removal and disposal work must be carried out by an Authorized Mazda Dealership.
- Be careful not to lose removed parts, and be sure that they are kept free of dirt, scratches, or damage.

PART NAME: MUD FLAP (FRONT)

PART NUMBER: DN4J V3 450

VEHICLE: MAZDA MX-30

NOTE

To the dealer

- Please turn over these instructions to the customer after installation.

To the customer

- Keep these instructions after installation. The instructions may be necessary for installing other optional parts or removal of this accessory.
- Should the vehicle or this accessory be resold, Always transfer these instructions to the next owner.



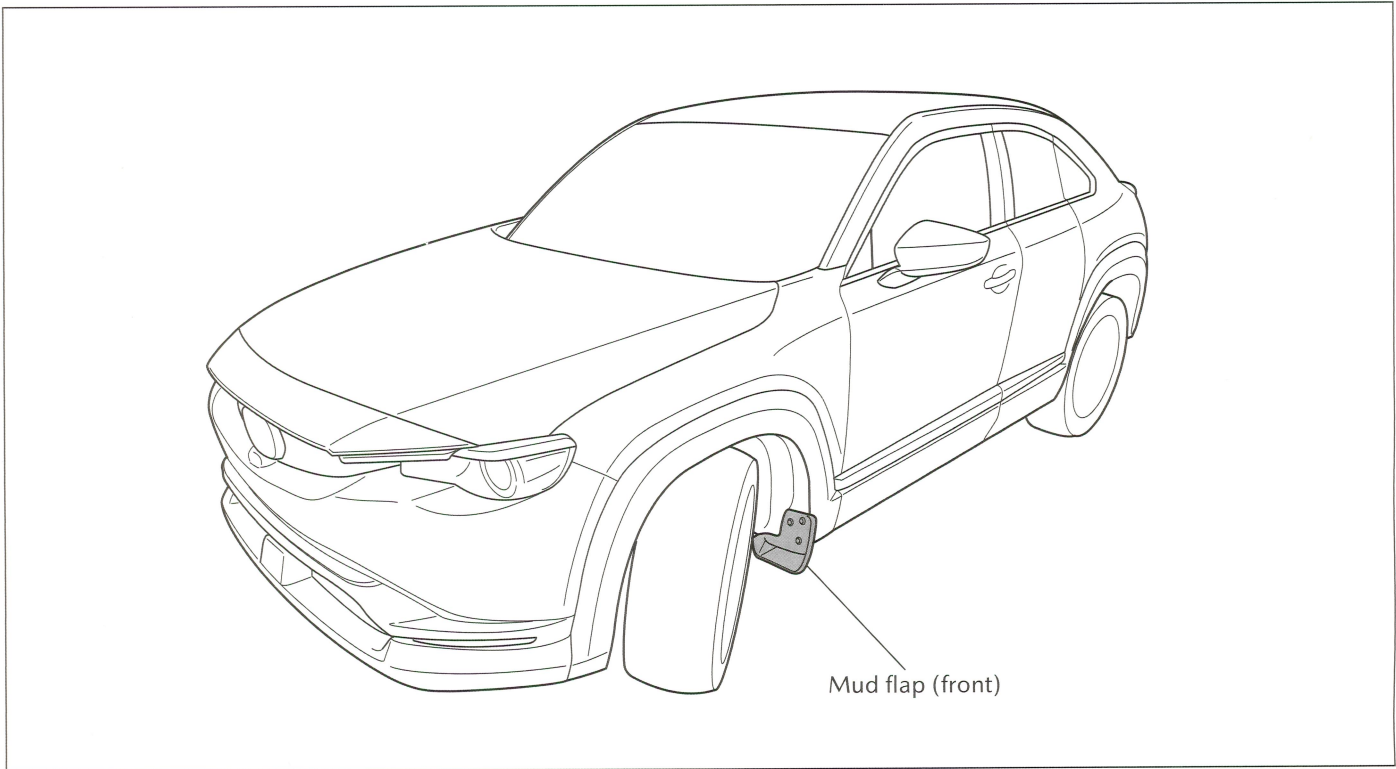

1. INSTALLATION VIEW

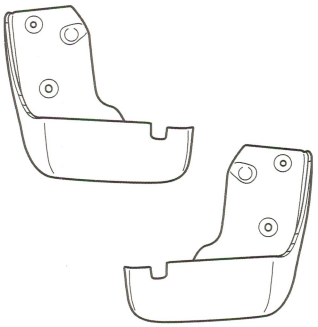

2. PARTS

- Before installation, verify that the kit includes all the following parts and that they are free of dirt, scratches, or damage.

Part	Part name	Qty	Part	Part name	Qty
	Mud flap (front) (RH/LH)	Each 1		Fastener	8

3. BEFORE INSTALLATION

REQUIRED TOOLS (Make sure they are at hand before starting work)

- ☆ Fastener remover
- ☆ Drill (φ 3 mm, φ 6 mm, φ 8 mm bits)
- ☆ Round file
- ☆ Punch

Other items to prepare



- ☆ Masking tape
- ☆ IPA (isopropyl alcohol) or white gasoline

WARNING

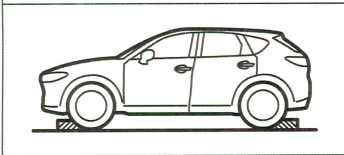
Park the vehicle on a flat, level surface, apply the parking brake firmly and block the wheels so that the vehicle does not move during installation. If this is not observed, the vehicle may move and injury may result.

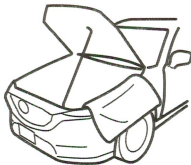
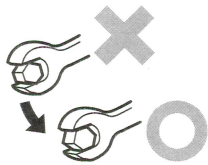
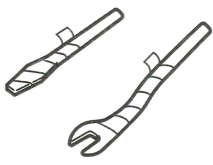
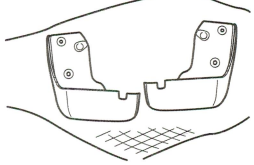
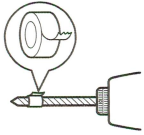

CAUTION

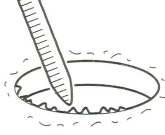
<p>Be sure to cover the vehicle body with protectors or mats to prevent stains, scratches and damage when removing/ installing the vehicle parts.</p>	<p>Using improper tools may cause damage and or broken parts. Use the correct tool for the installation.</p>	<p>Wrap protective tape around screwdrivers and fastener remover tools to prevent scratching the vehicle.</p>	<p>Put the removed parts and the parts in the kit on the protective sheet to prevent scratches.</p>
			
<p>【Drilling】 When drilling holes, be sure to wrap the drill bit with adhesive tape or similar to prevent drilling from going too deep.</p>	<p>【Drilling】 When drilling holes, hold the drill bit or hole saw so that it is perpendicular to the drilling surface so that the position of the hole being drilled does not shift.</p>	<p>【Drilling】 After drilling holes, file away any rough edges and burrs until the edges are smooth.</p>	
			

Advice

Refer to the Workshop Manual for removal and installation of applicable vehicle parts.



4. DOUBLE-SIDED TAPE ATTACHMENT

*"Attachment surface" refers to the overfender, and "part" refers to supplementary parts.

1. Avoid working in ambient temperatures of less than 15 °C.

The stickiness of the adhesive depends on the softness of the resin, and so the adhesive loses its stickiness and the adhesive strength drops at low temperatures (15 °C or less). Accordingly, avoid carrying out work in places where the ambient temperature is less than 15 °C. If working in places where the ambient temperature is less than 15 °C, you should heat the attachment surface and the part until they are warm enough.

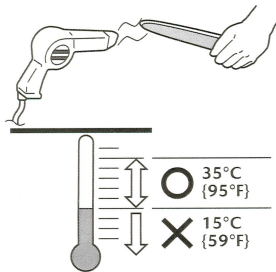

2. Attach evenly.

In order to ensure that the adhesive surface of the double-sided tape attaches correctly, it is necessary to press the adhesive surface of the tape against the attachment surface with a uniform force (50N) overall. In particular, press down sufficiently on the double-sided tape when the ends of the tape and the attachment surface are curved.

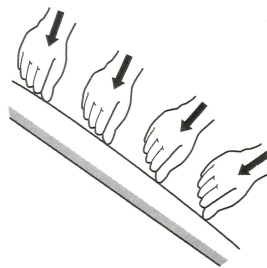

3. Clean the attachment surface.

If there is any dirt, grease or other contamination on the attachment surface, they may become attached to the double-sided tape, causing a drop in the adhesive strength of the double-sided tape.

You should clean the attachment surface before attaching the double-sided tape.

As a general rule, use mild detergent for interior surfaces, and use IPA (isopropyl alcohol) or white gas for exterior surfaces. After cleaning, let the area dry sufficiently.



4. Avoid getting the tape dirty.

If you touch the adhesive surface while working, oil from your hands can get onto the adhesive and cause a drop in the adhesive strength of the double-sided tape.

In addition, when working while wearing gloves, fibers and dirt from the gloves may become attached to the adhesive.

Take care to avoid contaminating the adhesive surface of the double-sided tape.

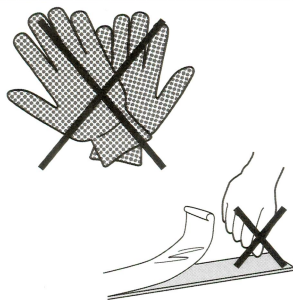

5. Handling after attaching the tape.

After the tape has been attached, the adhesive strength will not stabilize until 24 hours have passed, so do not drive or wash the vehicle or leave it exposed to rain for 24 hours.

In addition, never remove and reattach the double-sided tape once the product has been installed, as this will result in a dramatic drop in adhesive strength.

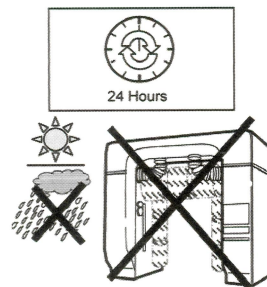

5. MUD FLAP (FRONT) INSTALLATION

- The illustrations showing the work procedure are for the left side of the vehicle; the same steps should be carried out for the right side as well.

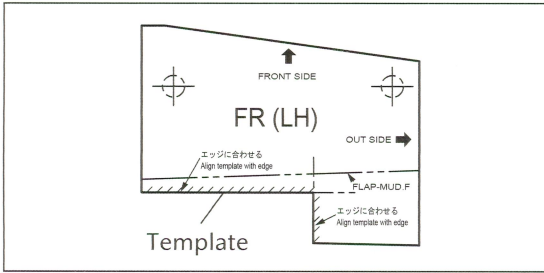

1. Cut the templates.

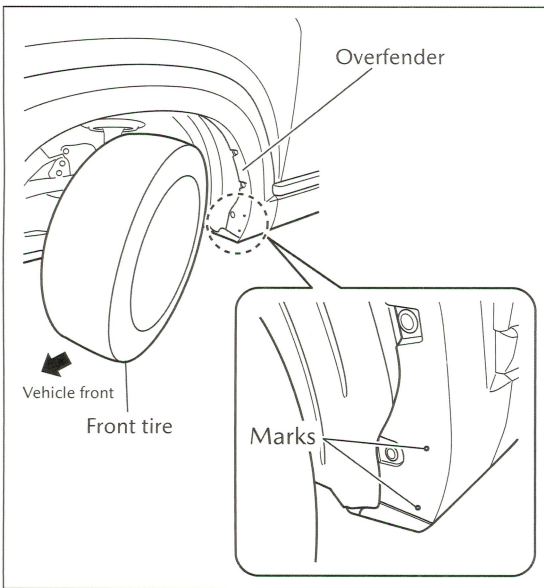

2. Check the marks at the mounting holes in the overfender (2 places).

- If the angle of the steering wheel is adjusted as shown in the diagram at left, working will be easier.

Advice

- If it is difficult to see the hollow shapes in the guide line when drilling holes, clean away any dirt, etc., and check the attachment position.

Detail of hollow

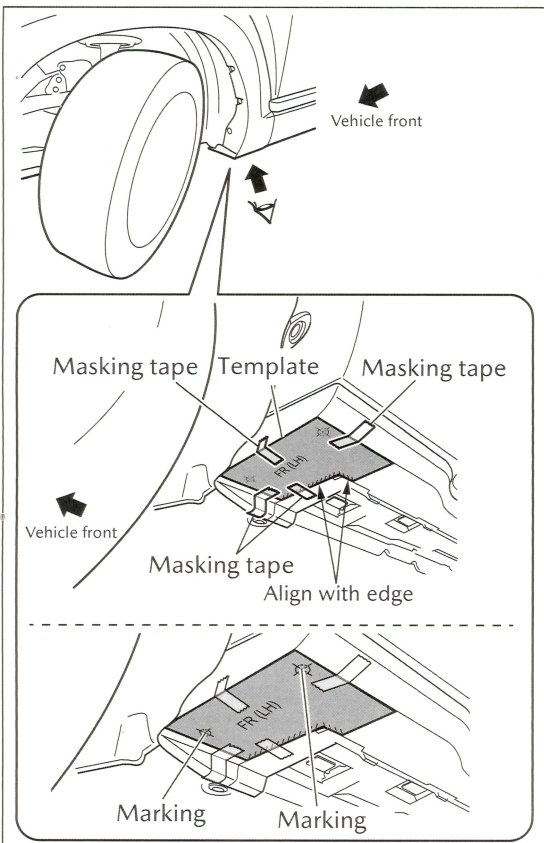
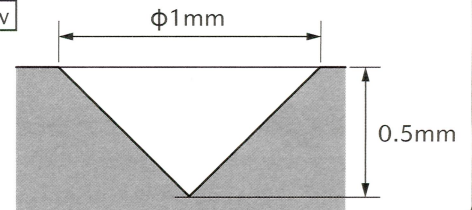

3. Attach the template to the bottom of the side step with masking tape as shown in the diagram at left.

4. Use a punch to make marks at the centers of the hole drilling locations in the templates. (2 places)

5. Remove the templates.

6. Use the drill to drill $\phi 8$ mm holes in stages at the locations of the marks at the mounting holes for the overfender and at the marks on the bottom of the side step.

$\phi 8$ mm hole drilling : $\phi 3$ mm \rightarrow $\phi 6$ mm \rightarrow $\phi 8$ mm

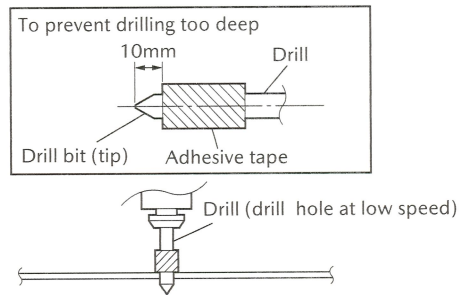
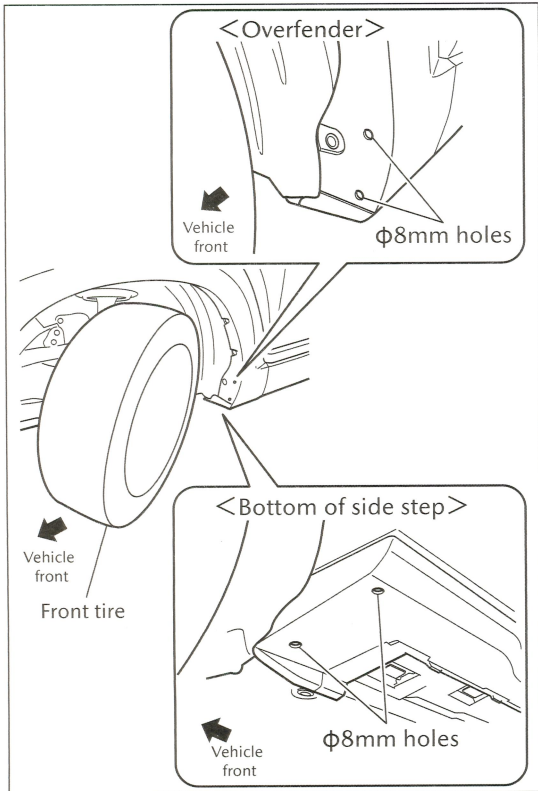

7. After drilling the holes, use a file to fully remove any burrs from the holes.

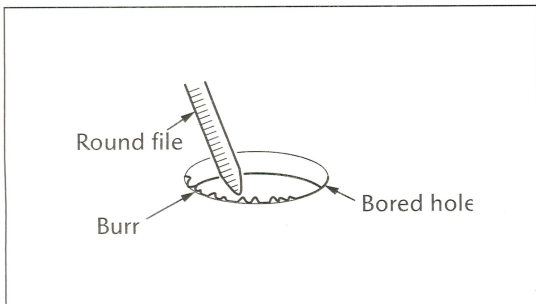

8. Use IPA (isopropyl alcohol) or white gasoline to clean the part of the vehicle (shaded area) where the double-sided adhesive tape of the mud flap (front) is to be attached.

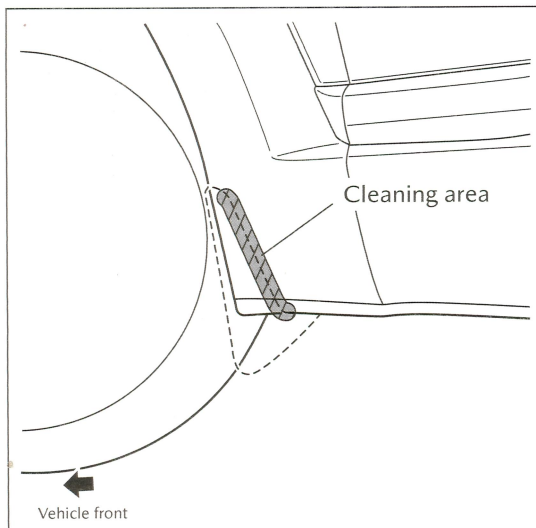

- After cleaning, let the area dry completely.

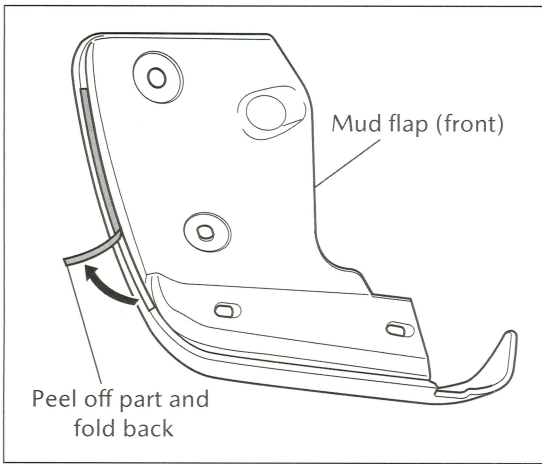

9. Peel off part of the backing paper from each piece of double-sided adhesive tape on the mud flap (front) and fold them back.

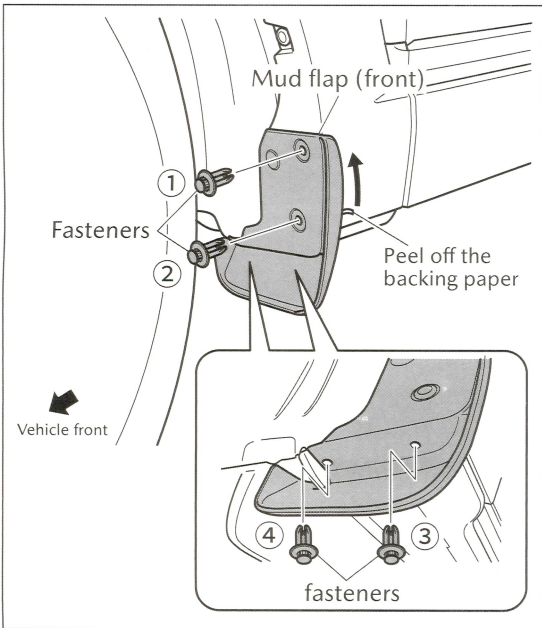

10. Set the mud flap (front) against the vehicle, and then install the fasteners in the order of ① to ④ .

11. Peel off the backing paper from the double-sided adhesive tape.

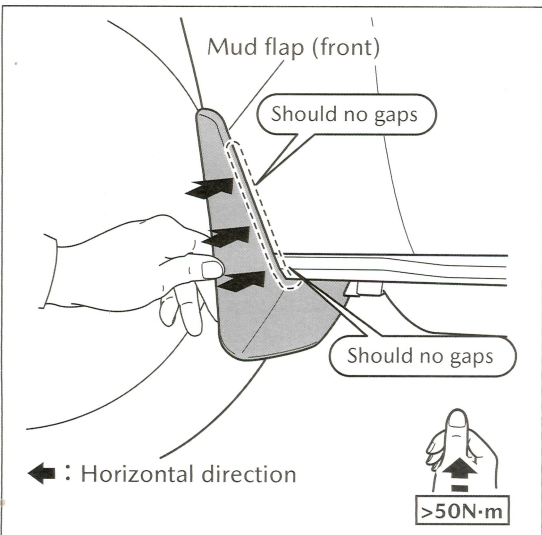

12. Press the mud flap (front) firmly against the vehicle to attach it so that there are no gaps between the contact surfaces as shown in the diagram at left.

- When attaching, press it with enough force (50 N or more) so that the vehicle rocks slightly.
- Do not detach the tape once it has been attached. If it is detached once it has been attached, the adhesive strength will drop.

6. CHECKING AFTER INSTALLATION

1. Check that there are no gaps between the overfender and mud flap (front) contact surfaces.
2. Check that the fasteners are securely installed.