

GENUINE ILLUMINATED SCUFF PLATE

INSTALLATION AND USER'S INSTRUCTIONS

Thank you for purchasing a Genuine Mazda Accessory.

Before removal and installation, Please thoroughly read these instructions.

For your safety, please read the contents of this booklet to properly install and use the illuminated scuff plate.

Keep these instructions with your vehicle records for future reference.



- There are several **⚠️WARNING** and **⚠️CAUTION** sections in this booklet concerning safety when installing or removing the illuminated scuff plate. Always read and follow the instructions in order to prevent injuries, accidents, and possible damage to the vehicle.

⚠️WARNING : Indicates a situation in which serious injury or death could result if the warning is ignored.

⚠️CAUTION : Indicates a situation in which bodily injury or damage to the vehicle could result if the caution is ignored.

- For areas indicating the tightening torque in this instruction manual, tighten to the specified torque by using a torque wrench. For areas in which the tightening torque is indicated inside parentheses (), the tightening torque is indicated as a reference value, however tightening using a torque wrench is not necessary.
- Do not modify the illuminated scuff plate.
- Do not install the illuminated scuff plate in any way other than described in the following instructions.
- If in doubt, please contact your Mazda dealer to install the accessory in order to prevent errors in installation.
- If you have any questions about the use of the accessory, ask your Mazda dealer for proper advice before using it.
- Mazda and its suppliers are not responsible for injuries, accidents, and damage to persons and property that arise from the failure of the dealer or installer to follow these instructions.
- To ensure safety and reliability of the work, installation, removal and disposal work must be carried out by an Authorized Mazda Dealership.
- Be careful not to lose removed parts, and be sure that they are kept free of dirt, scratches, or damage.

PART NAME: ILLUMINATED SCUFF PLATE
PART NUMBER: DFR5 V1 370
VEHICLE: MAZDA CX-30

NOTE

To the dealer

- Please turn over these instructions to the customer after installation.

To the customer

- Keep these instructions after installation. The instructions may be necessary for installing other optional parts or removal of this accessory.
- Should the vehicle or this accessory be resold, Always transfer these instructions to the next owner.



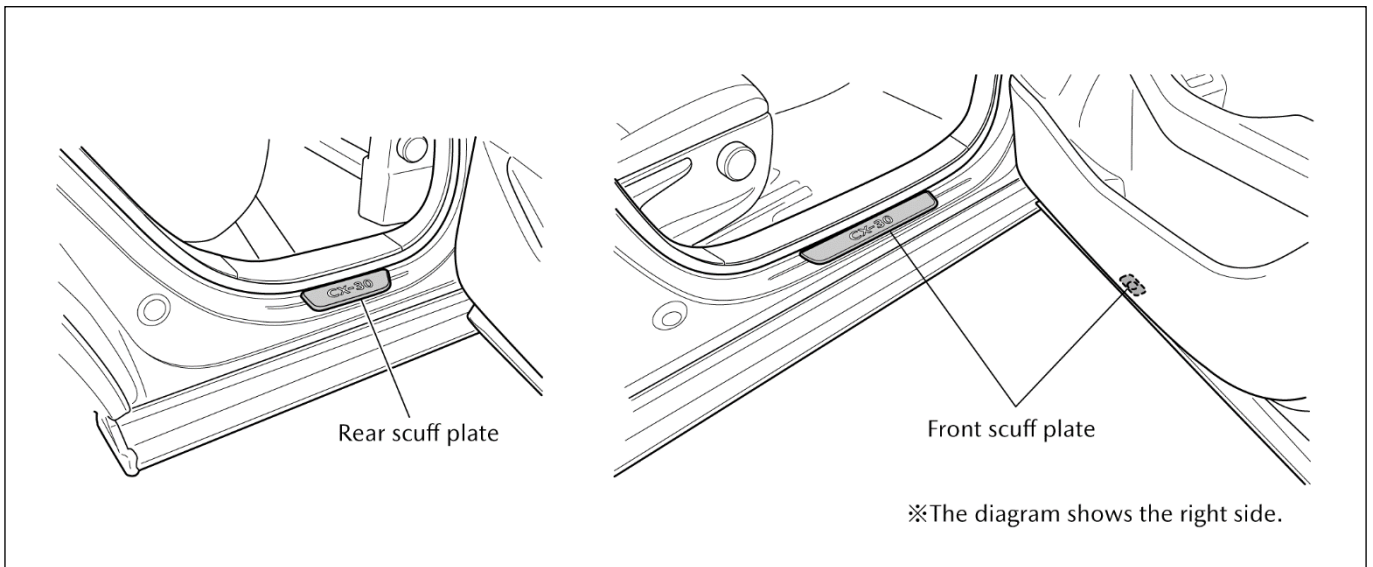

1. INSTALLATION VIEW

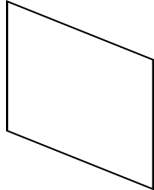
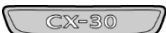
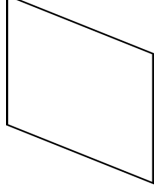

2. PARTS

- Before installation, verify that the kit includes all the following parts and that they are free of dirt, scratches, or damage.

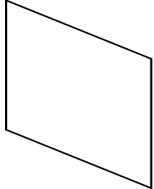
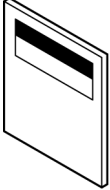
Part	Part name	Qty	Part	Part name	Qty
	Front scuff plate (RH/LH common)	2		Template (LH for front) (RH for front)	Each 1
	Rear scuff plate (RH/LH common)	2		Template (LH for rear) (RH for rear)	Each 1
	Magnet set (Magnet/cover) (RH/LH common)	2 sets		Template (For magnet)	1
	Installation and user's instructions	1			

3. BEFORE INSTALLATION

REQUIRED TOOLS (Make sure they are at hand before starting work)

☆ Scissor

! WARNING

Park the vehicle on a flat, level surface, apply the parking brake and block the wheels so that the vehicle does not move during installation.



! CAUTION

Put the removed parts and the parts in the kit on the protective sheet to prevent scratches.

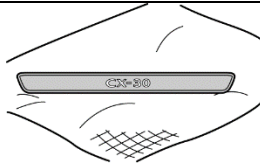

4. DOUBLE-SIDED TAPE ATTACHMENT

* "Attachment surface" refers to the bumper, and "part" refers to supplementary parts.

1. Avoid working in ambient temperatures of less than 15 °C.

The stickiness of the adhesive depends on the softness of the resin, and so the adhesive loses its stickiness and the adhesive strength drops at low temperatures (15 °C or less). Accordingly, avoid carrying out work in places where the ambient temperature is less than 15 °C. If working in places where the ambient temperature is less than 15 °C, you should heat the attachment surface and the part until they are warm enough.

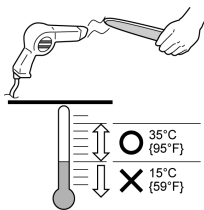

2. Attach evenly.

In order to ensure that the adhesive surface of the double-sided tape attaches correctly, it is necessary to press the adhesive surface of the tape against the attachment surface with a uniform force (50N) overall. In particular, press down sufficiently on the double-sided tape when the ends of the tape and the attachment surface are curved.

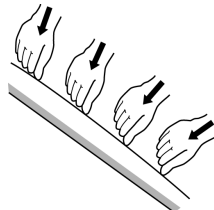

3. Clean the attachment surface.

If there is any dirt, grease or other contamination on the attachment surface, they may become attached to the double-sided tape, causing a drop in the adhesive strength of the double-sided tape. You should clean the attachment surface before attaching the double-sided tape. As a general rule, use mild detergent for interior surfaces, and use IPA (isopropyl alcohol) or white gas for exterior surfaces. After cleaning, let the area dry sufficiently.

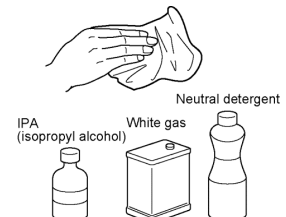

4. Avoid getting the tape dirty.

If you touch the adhesive surface while working, oil from your hands can get onto the adhesive and cause a drop in the adhesive strength of the double-sided tape. In addition, when working while wearing gloves, fibers and dirt from the gloves may become attached to the adhesive. Take care to avoid contaminating the adhesive surface of the double-sided tape.



5. Handling after attaching the tape.

After the tape has been attached, the adhesive strength will not stabilize until 24 hours have passed, so do not drive or wash the vehicle or leave it exposed to rain for 24 hours. In addition, never remove and reattach the double-sided tape once the product has been installed, as this will result in a dramatic drop in adhesive strength.

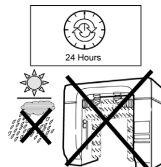

5. FRONT SCUFF PLATE INSTALLATION

- The diagrams showing the work procedure are for the right side of the vehicle; the same steps should be carried out for the left side as well.
- Do not remove the protective film until all work has been completed.

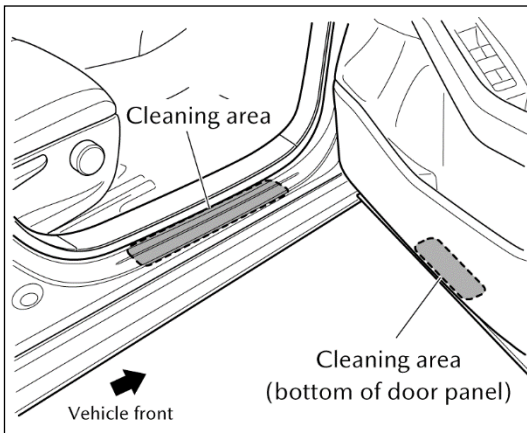

Front scuff plate installation

1. Open the front door.
2. Clean the attachment area for the front scuff plate using a cloth or similar which has been moistened with IPA (isopropyl alcohol) or white gas to remove any oil and dirt, and then dry the area completely.

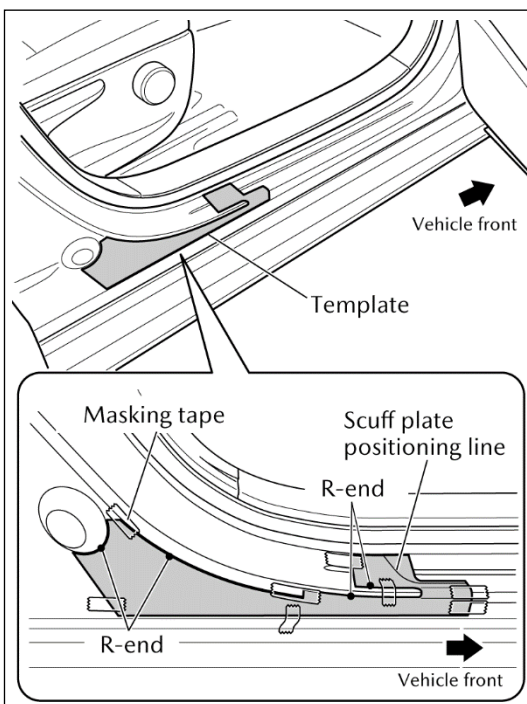

3. Cut the template (for front).
4. Align the cut template with the R ends of the vehicle as shown in the diagram at left, and then attach it using masking tape.
5. Temporarily attach the front scuff plate to the vehicle so that it follows the scuff plate positioning line on the template, and check that it follows the shape of the vehicle.

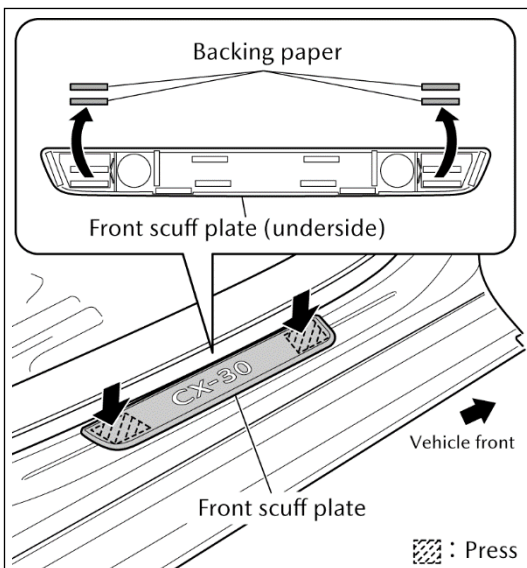

6. Remove all of the backing paper (4 places) from the double-sided adhesive tape on the front scuff plate (underside)
7. Set the front scuff plate so that it follows the scuff plate positioning line on the template, and install it to the vehicle.
8. Remove the template
9. Press down firmly on the front scuff plate.

- Check that the gap around the outer edge of the front scuff plate is uniform.

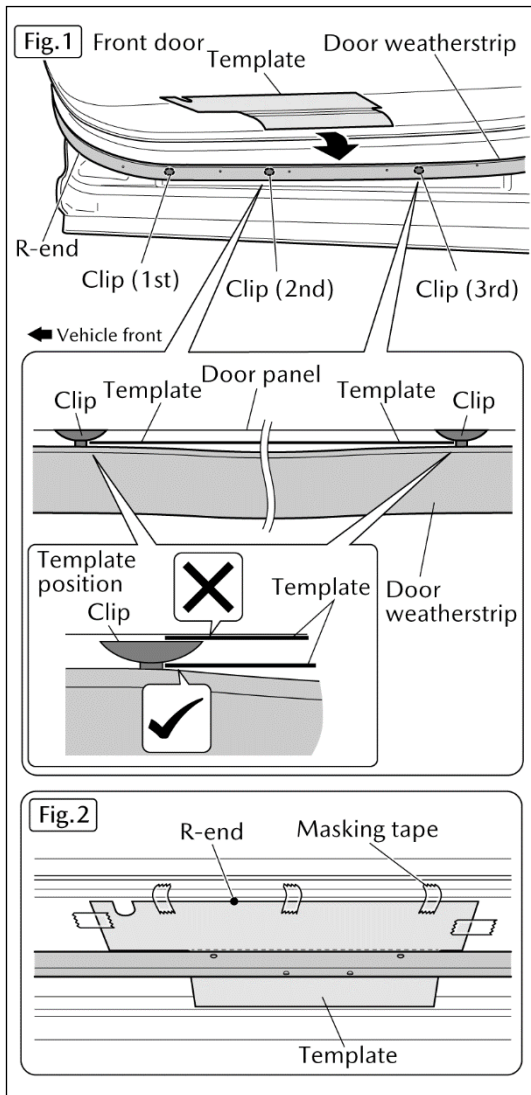

Magnet set installation

1. Cut the template.
2. Fold back the door weatherstrip shown in Fig. 1, and then check the clip positions.
3. Insert the template between the 2nd and 3rd clips from the front R-end as shown in Fig. 1, align it with the R-ends as shown in Fig. 2, and then attach it with masking tape.

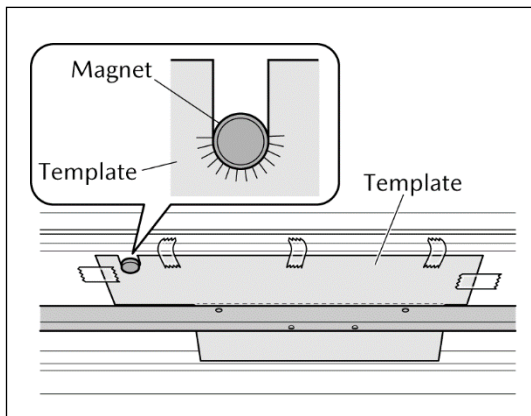

4. Place the magnet at the magnet position indicated on the template.
5. Remove the template.

⚠ CAUTION

- Be careful not to move the magnet when removing the template.

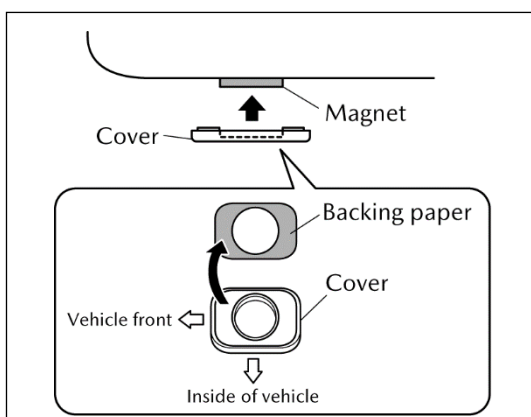

6. Remove all of the backing paper from the double-sided adhesive tape on the cover.
7. Align the cover with the magnet, and install it to secure the magnet.

⚠ CAUTION

- Be careful not to move the magnet which is attached to the door panel when installing the cover.

8. Remove the protective film (clear) from the front scuff plate.

6. REAR SCUFF PLATE INSTALLATION

- The diagrams showing the work procedure are for the right side of the vehicle; the same steps should be carried out for the left side as well.
- Do not remove the protective film until all work has been completed.

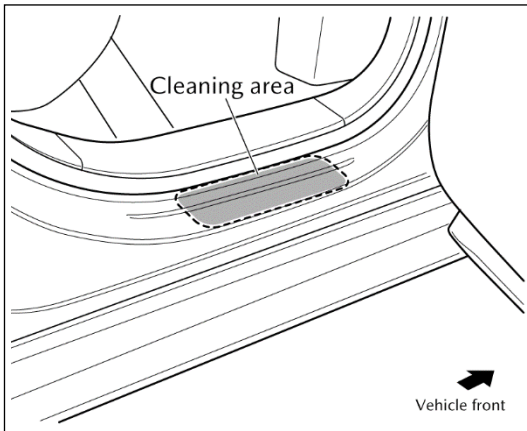

Rear scuff plate installation

1. Open the rear door.
2. Clean the attachment area for the rear scuff plate using a cloth or similar which has been moistened with IPA (isopropyl alcohol) or white gas to remove any oil and dirt, and then dry the area completely.

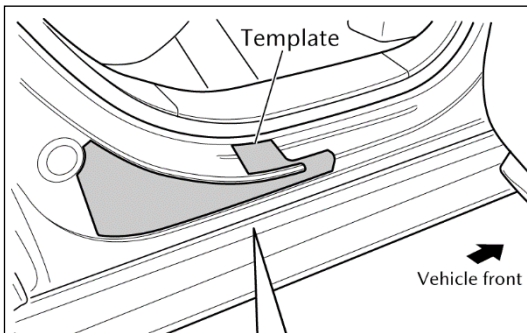

3. Cut the template (for rear).
4. Align the cut template with the R ends of the vehicle as shown in the diagram at left, and then attach it using masking tape.
5. Temporarily attach the rear scuff plate to the vehicle so that it follows the scuff plate positioning line on the template, and check that it follows the shape of the vehicle.

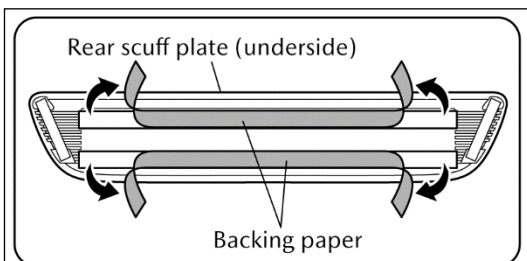
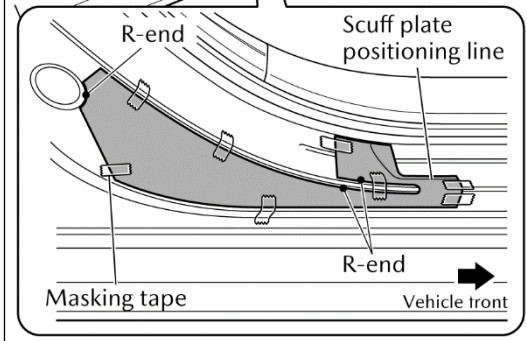

6. Peel off about 20 to 30 mm of of the backing paper (2 places) from the double-sided adhesive tape on the rear scuff plate (underside), and fold the pieces back.
7. Set the rear scuff plate so that it follows the scuff plate positioning line on the template, and install it to the vehicle.
8. Remove the template.
9. Peel off all of the backing paper.
10. Press down firmly on the rear scuff plate in the places where the double-sided adhesive tape is.

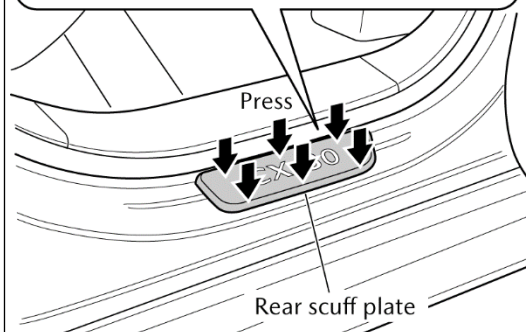

- Check that the gap around the outer edge of the rear scuff plate is uniform.

11. Remove the protective film (clear) from the rear scuff plate.

7. CAUTIONS ON HANDLING

Be sure to observe the following when using and handling (cleaning) the illuminated scuff plates.

Use

- Check that the illumination turns on when the door is opened, and that it automatically switches off after approximately 30 seconds.

Cautions on handling

- If the parts become dirty, wipe them clean with a soft cloth which has been moistened with diluted neutral detergent.
- When wiping the scuff plates, they may move forward or back by about 2mm, but this is the allowable margin of movement required for removing and installing the scuff plates and is not the sign of a defect.
- Keep items such as clocks, precision machinery, magnetic recording devices and electronic recording devices away from the magnets.

8. BATTERY REPLACEMENT

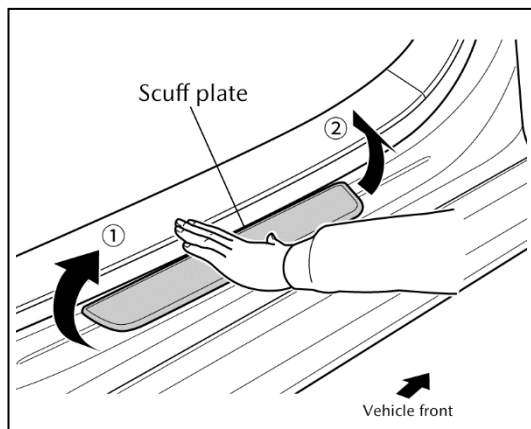

1. Press down on the middle of the scuff plate with one hand.
2. Remove the scuff plate by first lifting up the rear end of the scuff plate, and then lifting up the front end.

- Do not lift up the scuff plate from the outside edge. This will result in damage to the scuff plate.

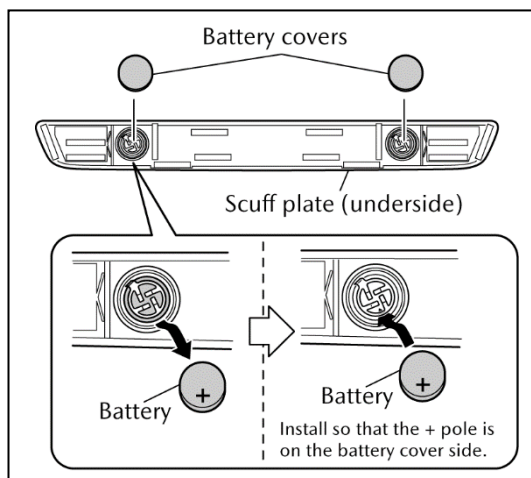
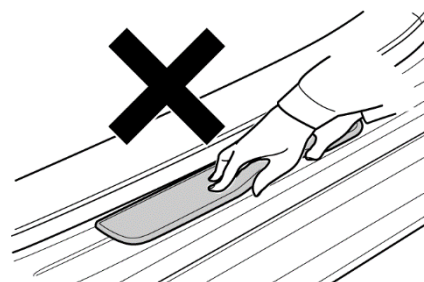

3. Turn the scuff plate upside-down, and then remove the battery covers.
4. Take out the batteries, and insert fresh batteries.
5. Install the battery covers.

- Batteries: Lithium CR 2025 batteries/2 per scuff plate (Total 4 batteries per vehicle)

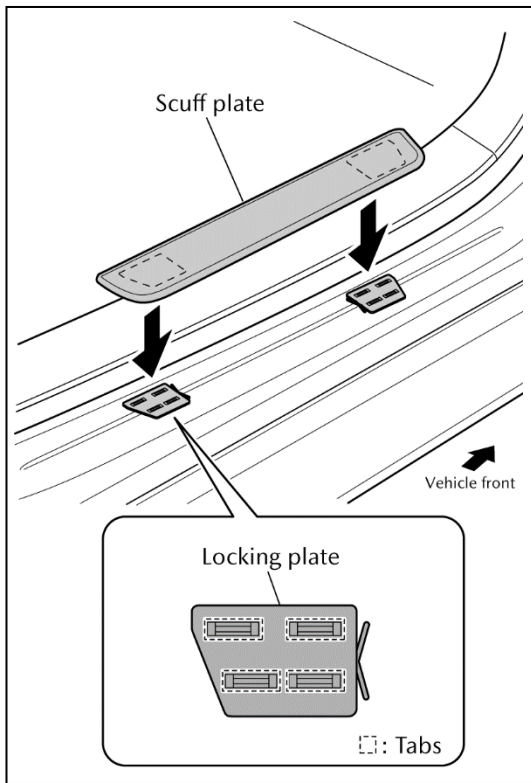

6. Install the scuff plate so that it fits into the locking plates which are attached to the side frame of the vehicle.
Check that the scuff plate clicks into place when fitting it to the vehicle.

- When replacing the scuff plate batteries, check that the gap around the outer edge of the scuff plate is uniform and that the scuff plate itself is properly secured.