



elizabeth parker
— ENGLAND —

THE SIGNATURE COLLECTION



THE SIGNATURE COLLECTION

Design Concept

A twist on a timeless design, with a delicate diameter of 14mm and featuring a stone that protrudes from the edge of the casing before dropping down to create a slight concave dip. The Signature Collection pieces will come to life when hit by the light. Our standard cufflink bascule ensure they are easy to put on and wear too. These designs include natural semi-precious stones, so tones and patterns may vary.

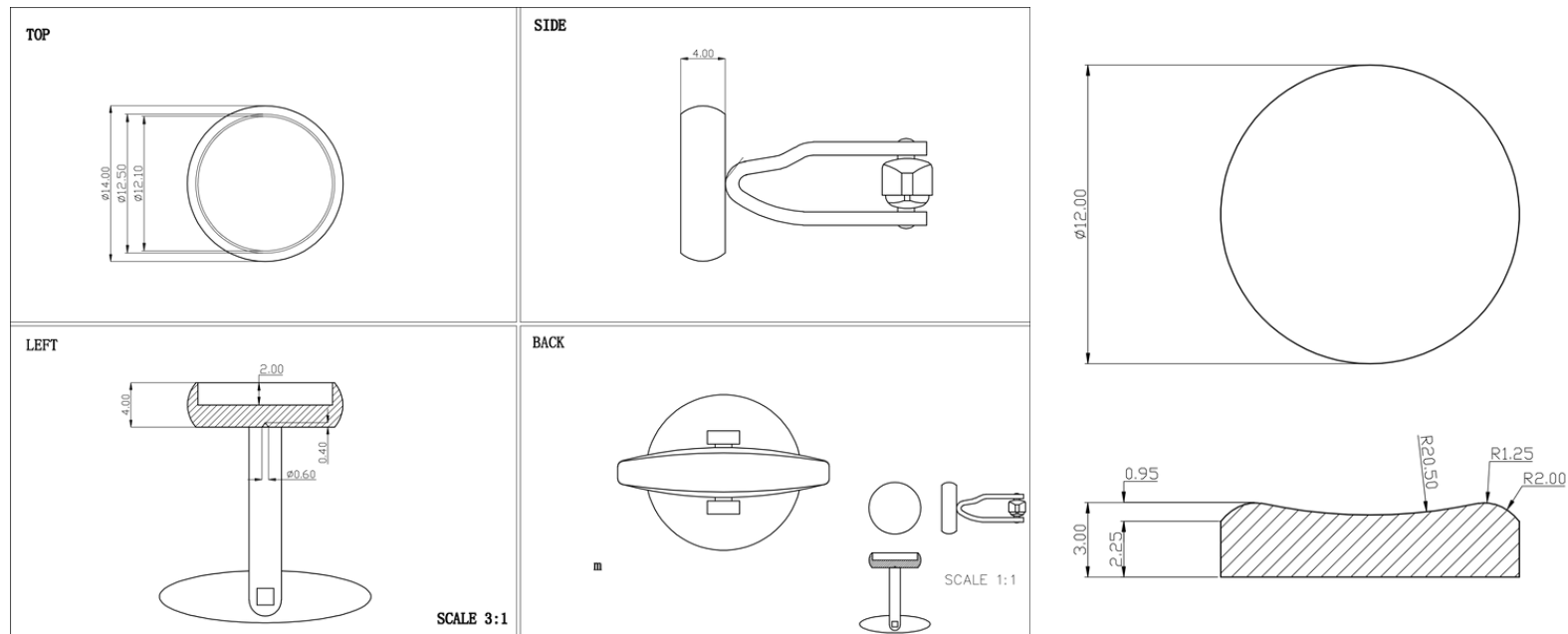

NO 1

ONYX



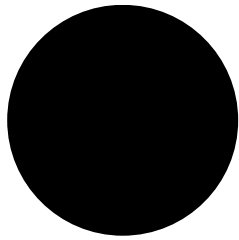

N_o 1

BLACK ONYX / GOLD

Classic / Black Tie/ Exclusive

| | |
|--------------|-------------|
| CONTEMPORARY | TRADITIONAL |
| EVENING | NATURAL |

"Love recognises no barriers, it jumps hurdles, leaps fences, penetrates walls to arrive at its destination, full of hope."

MAYA ANGELOU



Nº 2

MOTHER OF PEARL





№ 2

MOTHER OF PEARL / GOLD

White Wedding / Romance / Boujee

| | |
|--------------|-------------|
| CONTEMPORARY | TRADITIONAL |
| EVENING | NATURAL |

"...true love is never blind, but rather brings an added light."

P H O E B E C A R Y



NO 3

SODALITE

lemon and thistle



coloursbridesmaid



creative union



emmaline bride



Empiria Studios

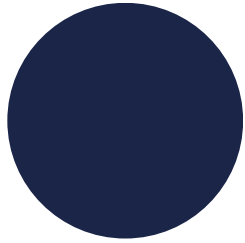

№ 3

SODALITE / ROSE GOLD

Navy/ Midnight Blue Wedding/ Opulent

| | |
|---------------|-------------|
| CONTEMPORARY | TRADITIONAL |
| SOPHISTICATED | NATURAL |

“A happy marriage is a long conversation
which always seems too short.”

ANDRÉ MAUROIS



№ 4

GREEN AVENTURINE



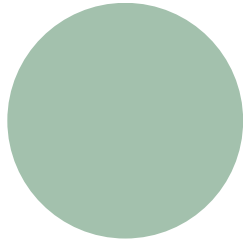

№ 4

GREEN AVENTURINE / SILVER

Tranquil/ Verdant/Soft Green

| | |
|---------------|-------------|
| CONTEMPORARY | TRADITIONAL |
| SOPHISTICATED | NATURAL |

“Happy marriages begin when we marry the ones we love, and they blossom when we love the ones we marry.”

TOM MULLEN



№ 5

ROSE
QUARTZ



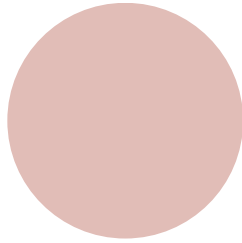

№ 5

ROSE QUARTZ / ROSE GOLD

Pink / Rose Romance / Serenity

| | |
|---------------|-------------|
| CONTEMPORARY | TRADITIONAL |
| SOPHISTICATED | NATURAL |

“One day, in your search for happiness, you discover a partner by your side, and you realise that your happiness has come to help you search.”

ROBERT BRAULT



№ 6

**BLUE
AVENTURINE**



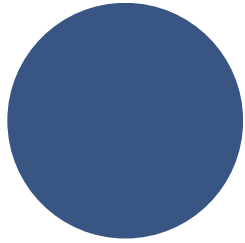

№ 6

BLUE AVENTURINE / SILVER

Coastal / Crisp / Serenity

| | |
|---------------|-------------|
| CONTEMPORARY | TRADITIONAL |
| SOPHISTICATED | NATURAL |

“One day, in your search for happiness, you discover a partner by your side, and you realise that your happiness has come to help you search.”

ROBERT BRAULT



№ 7

SMOKEY MOTHER OF PEARL

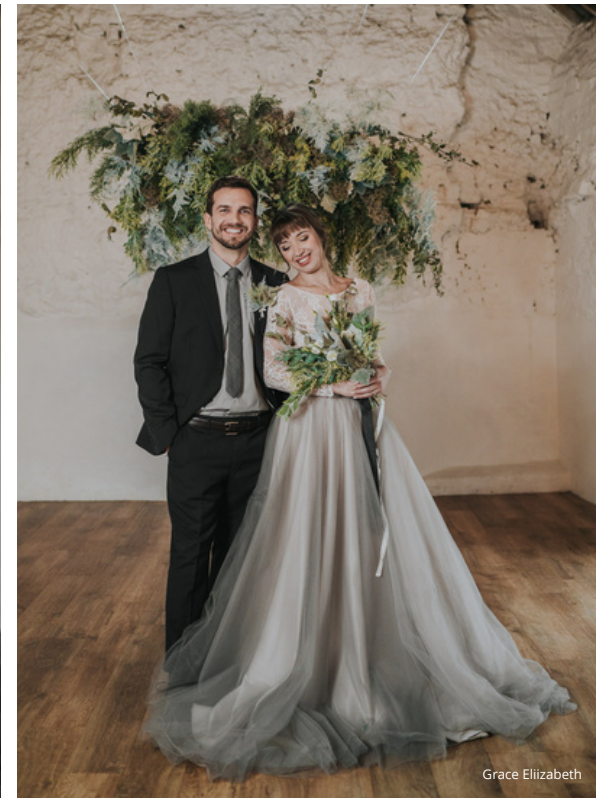

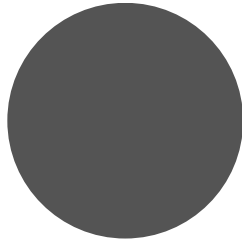

No 7

SMOKEY MOTHER OF PEARL/ SILVER

Grey / Dark / Contemporary

| | |
|---------------|-------------|
| CONTEMPORARY | TRADITIONAL |
| SOPHISTICATED | NATURAL |

“A great marriage is not when the ‘perfect couple’ comes together. It is when an imperfect couple learns to enjoy their differences.”

DAVE MEURER

