

ANZZI™

KF-AZ217BN
KF-AZ217ORB

SINGLE HOLE PULL DOWN KITCHEN FAUCET
SOLID BRASS
CERAMIC CARTRIDGE
FLOW RATE: 1.8GPM
LIMITED LIFETIME WARRANTY:

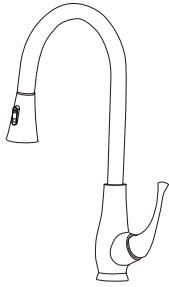

PREPARATION

MAKE SURE TO SHUT OFF THE WATER FLOW FROM YOUR HOT AND COLD SUPPLY LINES.

MAKE SURE YOUR MOUNTING HOLE IS CUT TO SIZE.



ITEMS YOU MAY NEED.

STEP 1

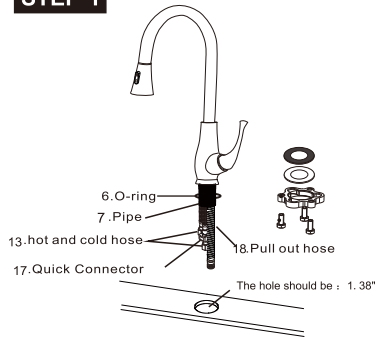

1.Position the faucet,o-ring on the installation surface.
And then put the faucet into center hole.

STEP 2

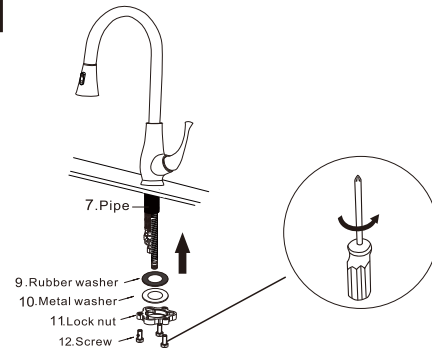

2.Adjust the position of the faucet and secure it with the fixing kit as photo.

STEP 4

4.Connect the flexible hose to water supply valve (not included),and tighten it with adjustable wrench.

DON'T OVER TIGHTEN!

Caution: make sure to connect the hot and cold flexible hoses to supply valves correctly.

Warning:

The supply valves are not included, please purchase them in plumb shop.

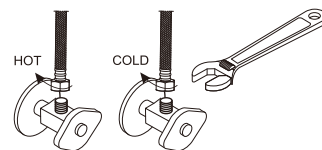

Faucet Installation Instructions

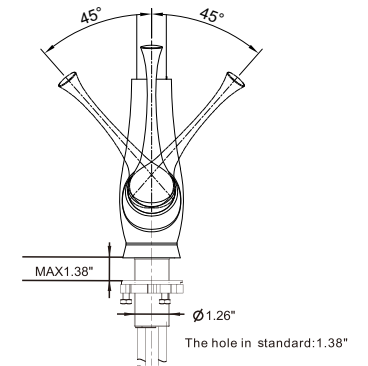
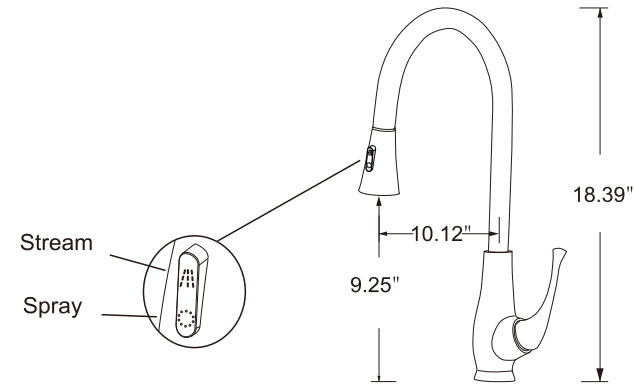

NSF/ANSI 61
NSF/ANSI 372

STEP 3

3.Proper installation of the hose weight will insure that the hand spray retracts smoothly.

On the handspray side of the hose, measure 15" down from the body of the faucet.Install the hose weight at this point.

Pull out on the handspray.It should move easily and retract smoothly .

Reposition the hose weight as necessary.

Make sure that the hot and cold supply hoses do not interfere with the handspray hose.They can be repositioned slightly if necessary.

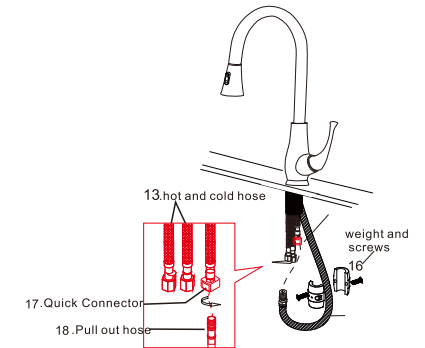

STEP 5

5.Remove the hand sprayer. Turn the faucet handle all the way on,turn on hot and cold water supply and flush water lines for one minute. Reinstall hand sprayer.

