

INSTALLATION INSTRUCTION

Item No.: 911-5V-LED

Warning!!! Shut Power Off At Fuse or Circuit Breaker .

Safety:

FOR YOUR SAFETY WARNING: BE SURE THE ELECTRICITY TO THE WIRES YOU ARE WORKING ON IS SHUT OFF; EITHER THE FUSE IS REMOVED OR THE CIRCUIT BREAKER IS SHUT OFF. Generally, you don't need special tools to install this fixture. Be sure to follow the steps in the order given. Under no circumstances should a fixture be hung on house electrical wires, nor should a swag type fixture be installed on a ceiling which contains a radiant type heating system. Read instructions carefully. If you are unclear as to how to proceed, consult a qualified electrician. NOTE: Proper wiring is essential for the safe operation of this fixture.

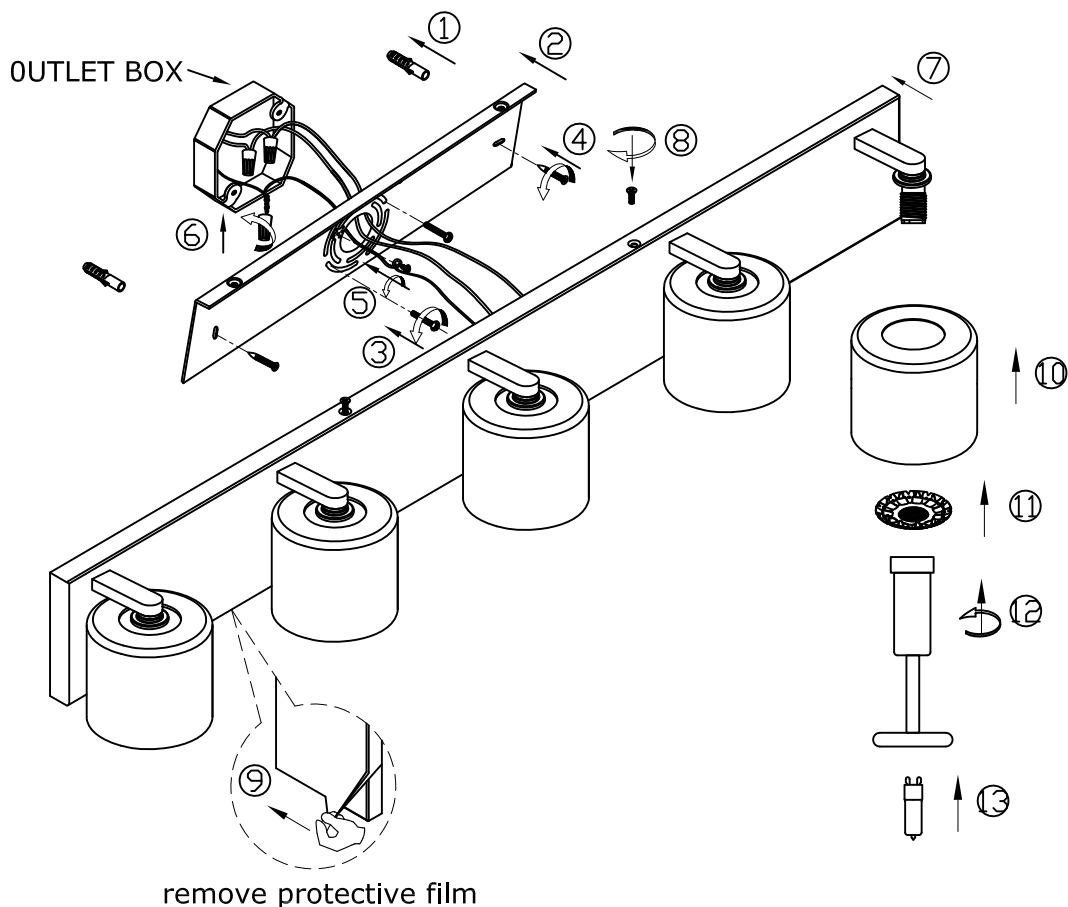

FEATURE

- 120V ~ 60Hz
 - Lamp Type: TYPE G9 SBLED 5×4W (2050LM)
- The lamp is for indoor use only
Turn power off to outlet before beginning installation

Wire Connections:

Connect the fixture wires to the Outlet Box wires as follows. Connect the White Fixture wire to the White Supply Wire, Connect the Black Fixture Wire to the Black Supply Wire. Make sure all wire Connectors are secure and do not easily pull off with the slight tug. If there is no Green Ground Wire from the Outlet Box, Connect the Fixture Ground Wire to the Cross Bar with the Green Grounding Screw provided. Once all wires are connected, tuck them carefully into Outlet Box.

CAUTION - TO REDUCE THE RISK OF FIRE, USE TYPE G9 SBLED bulb, or USE MAX 40 WATTS TYPE G9 T4 bulb. DISCONNECT POWER BEFORE SERVICING.