



ANZZI™

---

# TOWEL WARMER

## INSTALL GUIDE

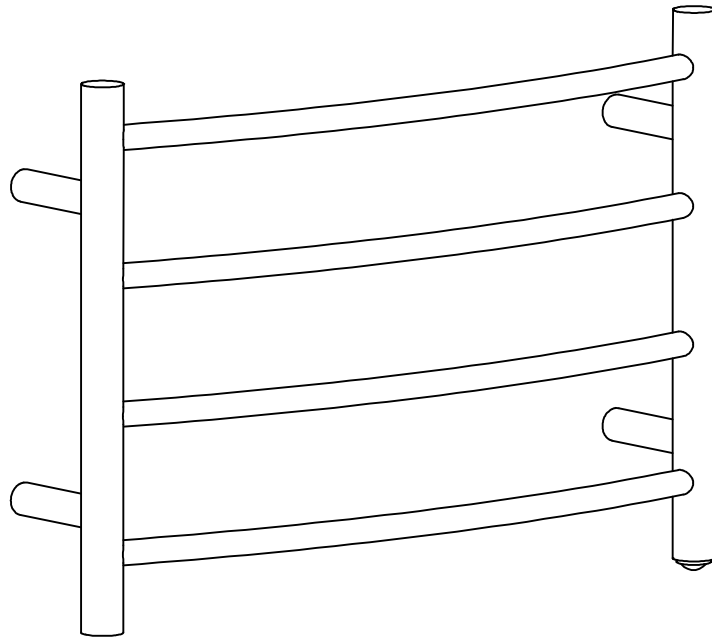

---

PERFECTION IS OUR TRADITION™

---

# TABLE OF CONTENTS

Before You Start	Pg. 1
Parts List	Pg. 2
Installation	Pg. 3
Care & Maintenance	Pg. 9
Warranty	Pg. 10
Registration	Final Page

## YOUR REVIEWS MATTER!



The ANZZI™ Family thanks you for your purchase and hopes you enjoy your very own ANZZI product for years to come! In the meantime let us know about your experience? We would love to hear your thoughts from the packaging to the quality and function of the product.

Also, we humbly request submitting as many pictures as possible along with your review. Millions of shoppers will want to know about your experience with our products. Don't just tell but show, too!

---

---

# BEFORE YOU START

Before you begin, read the installation instructions below. Observe all local building and safety codes.

Unpack and inspect the product for any shipping damages and ensure that none of the required pieces are missing. If you find damages, DO NOT INSTALL. Contact Customer Service at 1-866-44-ANZZI, if you need assistance or have questions while installing your towel warmer. ANZZI™ accepts no liability for any damage to the towel warmer, wall, or personal injury during installation.

## TOOLS AND MATERIALS

Safety glasses ▪ Tape Measure ▪ Level ▪ Drill ▪ Screwdriver ▪ Pencil

## WALL MOUNT INSTALLATION

1. Attach the wall supports to the towel warmer.
2. Using a level and tape measure, determine and mark the installation location of the wall supports. Drill mounting holes and install wall anchors in these locations.
3. Secure the mounting brackets onto the wall using the provided mounting screws.
4. Hang and adjust the towel warmer onto the mounting brackets. Ensure the towel warmer is firmly and safely fixed.
5. Plug the towel warmer into the wall socket.

## OPERATION AND MAINTENANCE

The red light indicates the towel warmer is in the on position. Always turn the power off when the towel warmer is not in use.

Note: Fabrics that contain soap or detergent residue may show what appears to be scorch marks. These marks are simply the discoloration of the residue.

---

# PARTS LIST

## Required Items

 Pencil

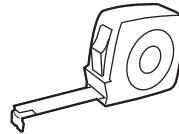

Measuring Tape



Allen Tool

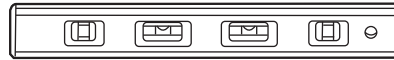

Leveler

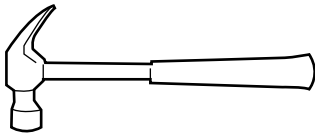

Hammer

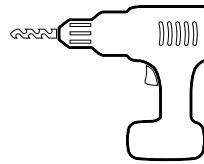

Power Drill



Philips ScrewDriver

---

## Included Hardware

1. & 2.

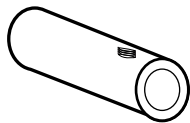

or

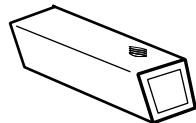

4x Wall Mounting Brackets w/ Screw Set  
(Rounded or Squared depending on model)

3.



4x Bracket Tub

4.



4x Long Screws

5.

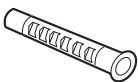

4x Wall Anchor

6.



4x Short Screws

7.



1x Allen Tool

---

PERFECTION IS OUR TRADITION™

---

# INSTALLATION

Fasten wall bracket to towel warmer body.

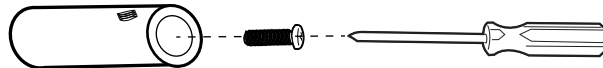

## Step 1

As shown in the picture, drill the short screw (6) through the hole in the metal bracket (1).

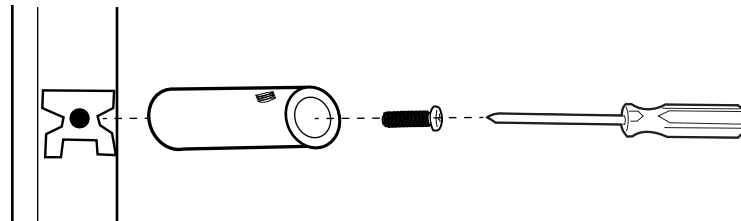

## Step 2

Use the short screw (6) to secure the bracket onto the metal pad on the vertical bar of the towel warmer.

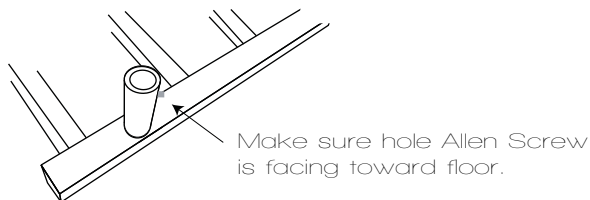

## Step 3

Fasten the short screw (6) using a screwdriver. Make sure the hole of the bracket (1) faces towards the floor when the towel warmer is mounted.

---

PERFECTION IS OUR TRADITION™

---

# INSTALLATION

Prepare for wall mounting.

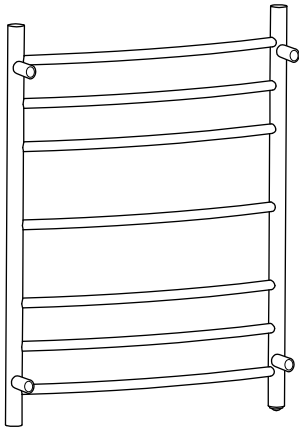

## Step 4

Attach the remaining three brackets (1) to the vertical bars by repeating steps 1, 2, and 3..

## Step 5

Using the measuring tape & level, measure and mark the four anchor locations. You will need to measure from A to B, A to C, D to D, and finally B to D. It's recommended to install the towel warmer a minimum of 24" (2') from the floor.

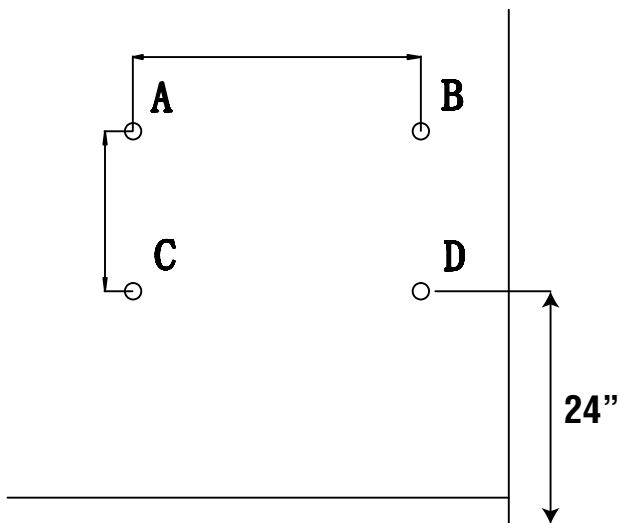
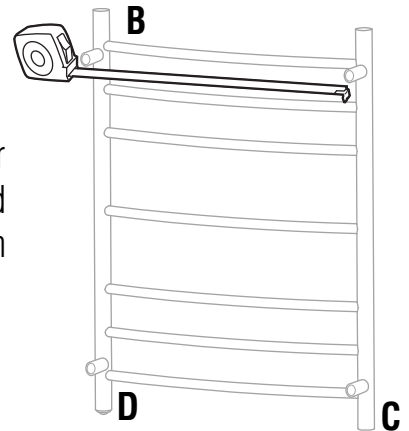

## Step 6

Once all the anchor points are marked on the wall (A, B, C, & D). Confirm the towel warmer brackets will align correctly with the markings.

---

PERFECTION IS OUR TRADITION™

---

# INSTALLATION

Figure 3

## Step 7

Using a drill, make a pilot hole into each marked point. Use a 5/16th drill bit.

## Step 8

Using the wall anchors supplied (5), hammer each one into the pilot holes.

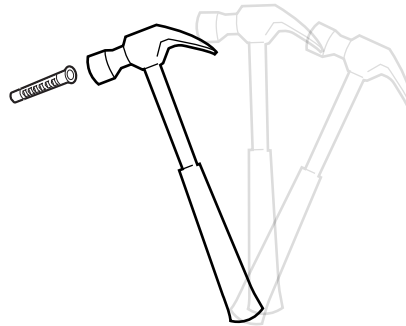

## Step 9

Insert the long screw (4) through the short bushing (3) provided. Then using the screwdriver secure it to the wall anchors (5).

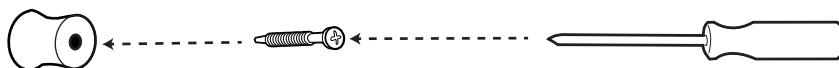

---

# INSTALLATION

Figure 4

## Step 10

Install the bracket onto the bushing on the wall.

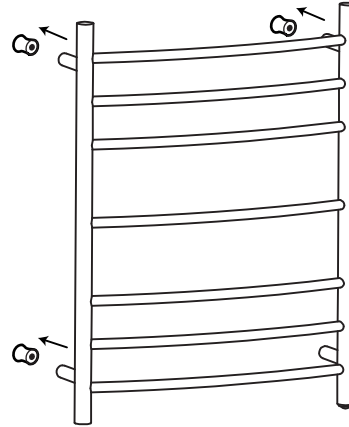

## Step 8

As shown in the picture, fasten the set screw (2) into the bracket hole (1) using the allen tool provided. Before fully tightening the set screws, make sure all brackets are set properly onto the short bushings (3).

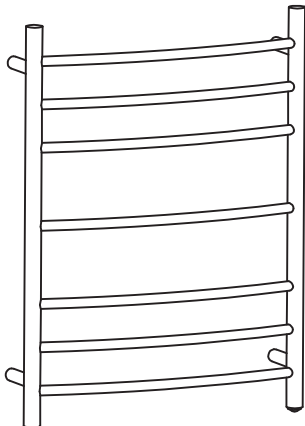
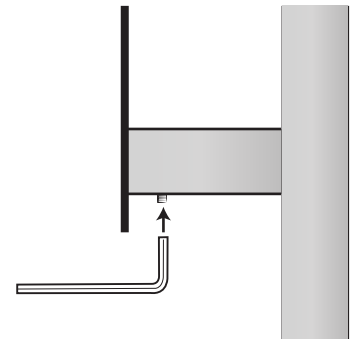

## Step 9

Double check all forn connections and using the level confirm the towel warmer is secured and aligned correctly.

And you're done!



---

# INSTALLATION

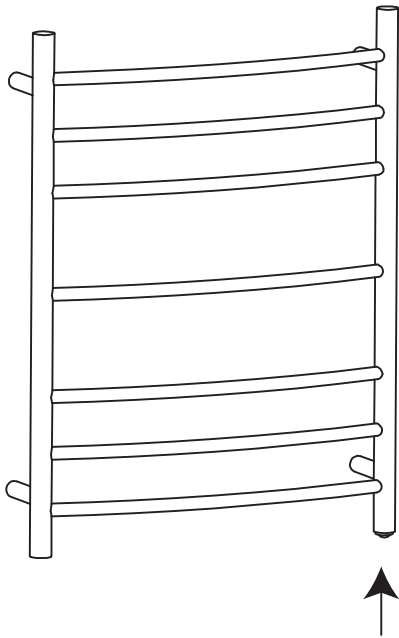

**On/Off Switch Located Below**

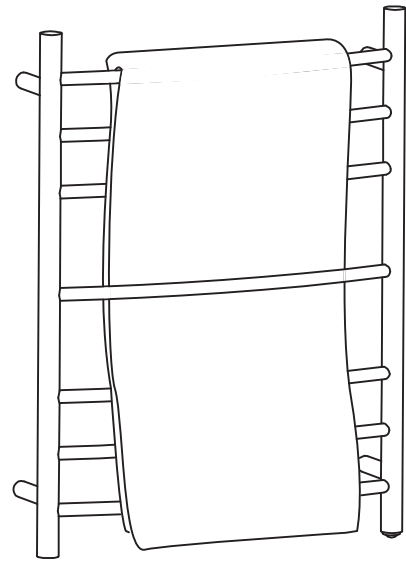

**Maximum Warmth**

For best results maximize the areas of contact between your towel and newly installed towel warmer by weaving the towel through the bars.

---

PERFECTION IS OUR TRADITION™

---

# INSTALLATION

Blank Page

---

PERFECTION IS OUR TRADITION™

---

## CARE AND MAINTENANCE

ANZZI™ products are crafted with superior quality standards and workmanship and are engineered to stand the test of time. However, that does not mean the product can be neglected and will need some care and cleaning.

It is recommended to use regular soap and hot water along with a non-abrasive cloth or sponge to regularly clean the product. This avoids any nasty build up or deposits which would be tougher to remove.

If you feel the use of stronger cleaning solutions or chemicals is necessary always test the cleaning solution or chemical on an inconspicuous area before applying to the entire surface.

Wipe all surfaces clean and rinse completely with water immediately after applying cleaner. Rinse and dry any overspray that lands on nearby surfaces.

DO NOT ALLOW THE CLEANER TO SOAK.

Following these simple principles will ensure you ANZZI™ product will remain as lustrous and stunning as the day it was first received. ENJOY!

Sincerely,

La Familia ANZZI™

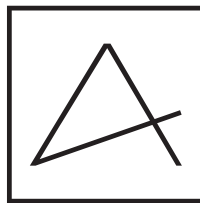

ANZZI™

Perfection is our Tradition™

---





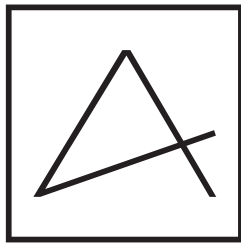

ANZZI™

---

Perfection is our Tradition™