

## INSTALLATION AND OPERATION MANUAL

# M-Series Condensing Boiler

### Wall-Mounted, Gas-Fired Solo Boiler

Central Heating Boiler



#### MODELS

M060S

M090S

M120S

M160S

Certified to ANSI Z21.13  
and CSA 4.9



#### WARNING

If the information in these instructions are not followed exactly, a fire or explosion may result causing property damage, personal injury, or loss of life.

- Do not store or use gasoline or other flammable vapors and liquids in the vicinity of this or any other appliance.
- WHAT TO DO IF YOU SMELL GAS
  - Do not try to light any appliance.
  - Do not touch any electrical switch; do not use any phone in your building.
  - Immediately call your gas supplier from a neighbor's phone. Follow the gas supplier's instructions.
  - If you cannot reach your gas supplier, call the fire department.
- Installation and service must be performed by a qualified installer, service agency or the gas supplier.

## READ AND SAVE THIS MANUAL

# Contents

<b>1. Welcome</b> .....	<b>4</b>
<b>2. Safety</b> .....	<b>5</b>
2.1 Safety Symbols .....	5
2.2 Safety Precautions.....	5
<b>3. About the Boiler</b> .....	<b>7</b>
3.1 Front View .....	7
3.2 Bottom View.....	8
3.3 Components .....	9
3.4 Specifications.....	10
3.5 Dimensions .....	11
3.6 Accessories .....	13
3.7 How to Remove the Front Panel .....	14
<b>4. Installation</b> .....	<b>15</b>
4.1 Installation Guidelines.....	15
4.2 What You'll Need.....	16
4.3 Items Included.....	17
4.4 Choose an Installation Location .....	18
4.5 Mount the Boiler to the Wall .....	20
<b>5. Venting</b> .....	<b>21</b>
5.1 Guidelines.....	21
5.2 Venting Installation Sequence.....	22
5.3 Termination Considerations.....	22
5.4 Venting Options.....	23
<b>6. Gas Supply</b> .....	<b>43</b>
6.1 Connect the Gas Supply.....	43
6.2 Gas Operating Instructions.....	45
6.3 Gas Pipe Sizing Reference Tables .....	46
<b>7. CH System Piping</b> .....	<b>48</b>
7.1 Guidelines.....	48
7.2 Instructions.....	48
7.3 Common CH Components .....	49
7.4 Piping Diagram for a Basic CH System.....	51
7.5 Hydraulic Separation .....	52
7.6 Connect the Pressure Relief Valves (DHW and CH).....	53
7.7 Connect the Condensate Drain Line.....	54
<b>8. DHW System Piping with Indirect Tank</b> .....	<b>56</b>
8.1 Guidelines.....	56
8.2 Indirect Tank Control Options .....	56

<b>9. Power Supply .....</b>	<b>57</b>
9.1 Guidelines.....	57
9.2 Electrical Connections .....	58
9.3 Post-Power Supply Connection Checklist.....	58
<b>10. Commissioning .....</b>	<b>59</b>
10.1 Safety Precautions.....	59
10.2 Instructions.....	59
10.3 Air Purge Process.....	62
<b>11. Post-Installation Checklist .....</b>	<b>63</b>
<b>12. Operation .....</b>	<b>65</b>
12.1 Start-Up Information .....	65
12.2 Control Panel.....	66
12.3 Basic Operation Settings.....	69
12.4 Parameter Settings .....	71
12.5 Outdoor Reset Control .....	76
12.6 Diagnostic Codes .....	79
12.7 Forced Hi/Low Fire Modes .....	83
12.8 Freeze Protection .....	84
<b>13. Maintenance .....</b>	<b>85</b>
13.1 Owner Maintenance.....	85
13.2 Licensed Professional Maintenance .....	86
13.3 Test the Ignition Safety Shut Off Device.....	88
<b>14. Appendices.....</b>	<b>89</b>
14.1 Approved Cleaners, Inhibitors and Antifreezes.....	89
14.2 Flush the CH Plumbing System .....	90
14.3 Boiler Parts .....	91
14.4 System Application Examples.....	98
14.5 Gas Conversion.....	104
14.6 Wiring Diagram.....	108
14.7 Ladder Diagram .....	109
14.8 CH Pressure Drop and Flow Curve.....	110
14.9 Resistance/Temperature Table for Sensors .....	111
14.10 Remove a Boiler from a Common Vent System .....	112
14.11 Massachusetts State Gas Regulations .....	113
14.12 Warranty .....	114

# 1 Welcome

Thank you for purchasing a Rinnai Condensing Boiler. Before installing and operating this boiler, be sure to read these instructions completely and carefully to familiarize yourself with the boiler's features and functionality.

## To the Consumer

- You must read the entire manual to properly operate the boiler.
- Keep this manual for future reference.
- As when using any appliance generating heat, there are certain safety precautions you should follow. See section "2.2 Safety Precautions" for detailed safety precautions.
- Be sure your boiler is installed by a licensed installer.
- If installing in the state of Massachusetts, read section "14.12 Massachusetts State Gas Regulations" in this manual.

## Acronyms and Abbreviations

Following is a list of common acronyms and abbreviations used in this manual:

<b>ANSI</b>	American National Standards Institute
<b>Btu</b>	British Thermal Unit
<b>CH</b>	Central Heating
<b>SOLO</b>	Heating only boiler capable of DHW through an indirect tank
<b>DHW</b>	Domestic Hot Water
<b>GPM</b>	Gallons per minute
<b>LP</b>	Liquid Propane
<b>LWCO</b>	Low Water Cut Off
<b>NG</b>	Natural Gas
<b>PP</b>	Polypropylene
<b>PRV</b>	Pressure Relief Valve
<b>PSI</b>	Pounds per square inch
<b>W.C.</b>	Inches water column

## To the Installer

- A trained and qualified professional must install the boiler, inspect it, and leak test it before use. The warranty will be voided due to any improper installation.
- The trained and qualified professional should have skills such as:
  - Gas line sizing
  - Connecting gas lines, water lines, valves, and electricity
  - Knowledge of applicable national, state, and local codes
  - Installing venting through a wall or roof
  - Training in installation of condensing boilers. Training on Rinnai M-Series Condensing Boilers is accessible at [www.trainingevents.rinnai.us](http://www.trainingevents.rinnai.us).
- Read all instructions in this manual before installing the boiler. The boiler must be installed according to the exact instructions in this manual.
- Proper installation is the responsibility of the installer.
- When installation is complete, leave this manual with the boiler or give the manual directly to the consumer.

### *For Your Records*

Dealer Name: \_\_\_\_\_

Dealer Phone: \_\_\_\_\_

Purchase Date: \_\_\_\_\_

Serial #: \_\_\_\_\_

*Located on left  
side of unit*



# 2 Safety

## WARNING

- If the information in these instructions is not followed exactly, a fire or explosion may result causing property damage, personal injury, or death.
- Do not store or use gasoline or other flammable vapors and liquids in the vicinity of this or any other appliance.
- WHAT TO DO IF YOU SMELL GAS:
  - Do not try to light any appliance.
  - Do not touch any electrical switch; do not use any phone in your building.
  - Immediately call your gas supplier from a neighbor's phone. Follow the gas supplier's instructions.
  - If you cannot reach your gas supplier, call the fire department.
- Installation and service must be performed by a qualified installer, service agency or the gas supplier.
- The warning signs in this manual are here to prevent injury to you and others. Please follow them explicitly.

## 2.1 Safety Symbols

This manual contains the following important safety symbols. Always read and obey all safety messages.



Safety alert symbol. Alerts you to potential hazards that can kill or hurt you and others.

## DANGER

Indicates an imminently hazardous situation which, if not avoided, will result in personal injury or death.

## WARNING

Indicates a potentially hazardous situation which, if not avoided, could result in personal injury or death.

## CAUTION

Indicates a potentially hazardous situation which, if not avoided, could result in minor or moderate injury. It may also be used to alert against unsafe practices.

## 2.2 Safety Precautions

The following precautions apply to the installer and consumer. Read and follow all instructions in this section.

- Before operating, smell all around the appliance area for gas. Be sure to smell next to the floor because some gas is heavier than air and will settle on the floor.
- Keep the area around the appliance clear and free from combustible materials, gasoline, and other flammable vapors and liquids.
- Do not store or use gasoline or other flammable vapors and liquids in the vicinity of this or any other appliance.
- Combustible construction refers to adjacent walls and ceiling and should not be confused with combustible or flammable products and materials. Combustible and/or flammable products and materials should never be stored in the vicinity of this or any gas appliance.
- Always check the water temperature before entering a shower or bath.

- Do not use this appliance if any part has been under water. Immediately call a licensed professional to inspect the appliance and replace any part of the control system and any manual gas control valve which has been under water.
- Do not use substitute materials. Use only parts certified for the appliance.
- Should overheating occur or the gas supply fail to shut off, turn off the manual gas control valve to the appliance.
- It is strongly recommended that you use a trained and qualified professional who has attended a Rinnai installation training class to adjust parameter settings.
- Do not use an extension cord or adapter plug with this appliance.
- Any alteration to the appliance or its controls can be dangerous and will void the warranty.
- To protect yourself from harm, before performing maintenance:
  - Turn off the electrical power supply by unplugging the power cord or by turning off the electricity at the circuit breaker. (The boiler controller does not control the electrical power.)
  - Turn off the gas at the gas control, usually located immediately below the boiler.
  - Turn off the incoming water supply. Turning off the water for the central heating system is done at the boiler system filling station shut-off valve or the main water supply to the building.
  - Use only your hand to turn the manual gas control valve. Never use tools. If the manual gas control valve will not turn by hand, do not try to repair it; call a trained and qualified professional. Force or attempted repair may result in a fire or explosion.
- Proper venting is required for the safe operation of this appliance. Failure to properly vent this appliance can result in death, personal injury and/or property damage.
- Flammable liquids such as cleaning solvents, aerosols, paint thinners, adhesives, gasoline and propane must be handled and stored with extreme care. These flammable liquids emit flammable vapors and when exposed to an ignition source can result in a fire hazard or explosion. Flammable liquids should not be used or stored in the vicinity of this or any other gas appliance.
- DO NOT operate the boiler without the front panel installed. The front panel should only be removed for service/ maintenance or replacing internal components.
- BURN HAZARD. Hot exhaust and vent may cause serious burns. Keep away from the boiler. Keep small children and animals away from the boiler.
- Heating supply and return pipes leaving the boiler can be hot to touch.
- Install the vent system per local and national codes.
- Do not install this boiler above 10,200 ft (3,109 m).
- Do not obstruct combustion air to the boiler.
- Rinnai recommends that every home have a carbon monoxide (CO) alarm in the hallway near bedrooms in each sleeping area. Check batteries monthly and replace them annually.
- California law requires the following Proposition 65 warning to be provided:



## WARNING

This product can expose you to chemicals including Nickel compounds, Lead and Lead compounds which are known to the State of California to cause cancer, birth defects or other reproductive harm. For more information, visit [www.P65Warnings.ca.gov](http://www.P65Warnings.ca.gov).

# 3

# About the Boiler

## Topics in this section

- Front View
- Bottom View
- Components
- Specifications
- Dimensions
- Accessories
- How to Remove the Front Panel

The M-Series Condensing Boiler is a wall-mounted, gas-fired boiler designed to providing heating and domestic hot water.

For complete boiler information, refer to the “Rinnai M-Series Condensing Boiler Installation Manual” supplied with the boiler, or visit [rinnai.us](http://rinnai.us).

## 3.1 Front View

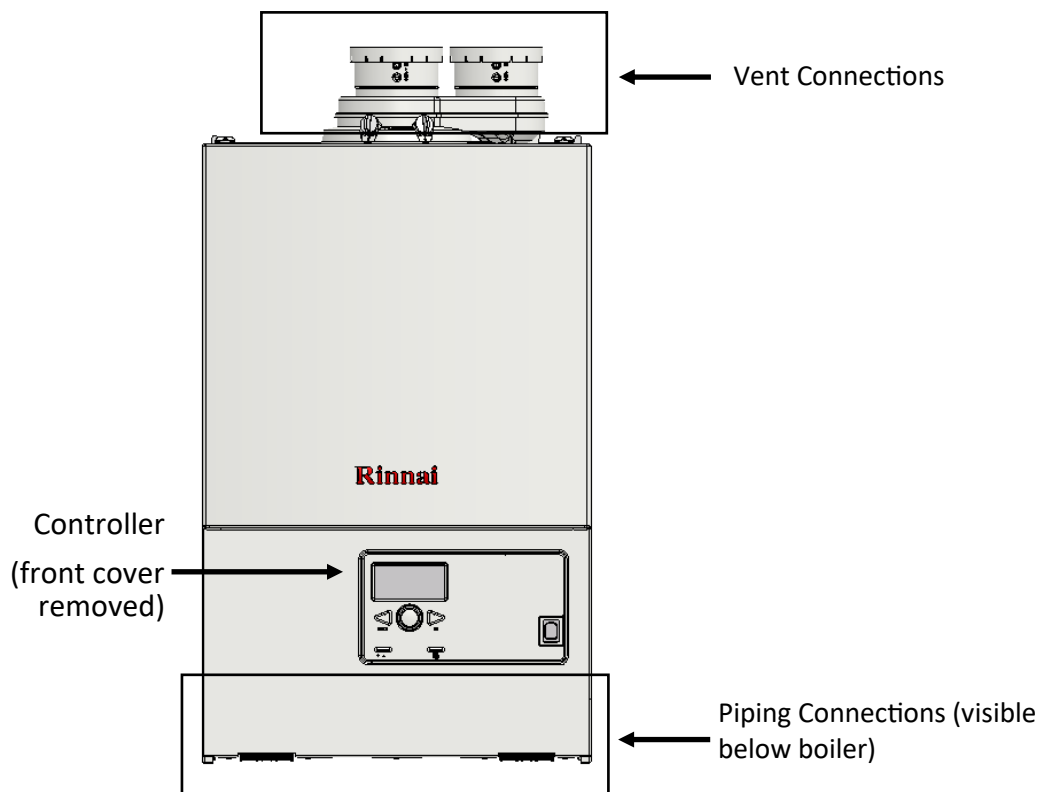

## 3.2 Bottom View

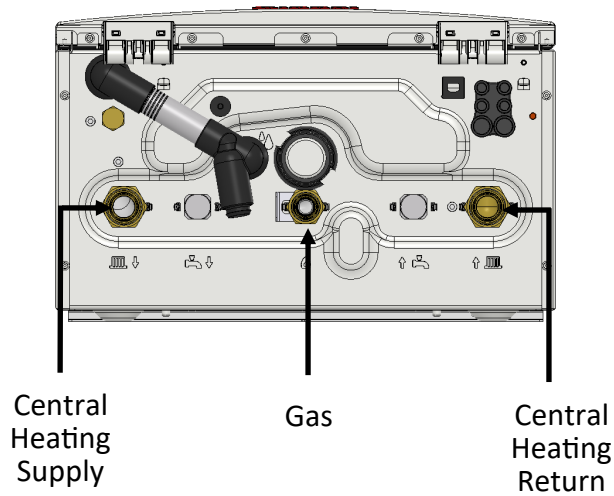

### Bottom View Piping

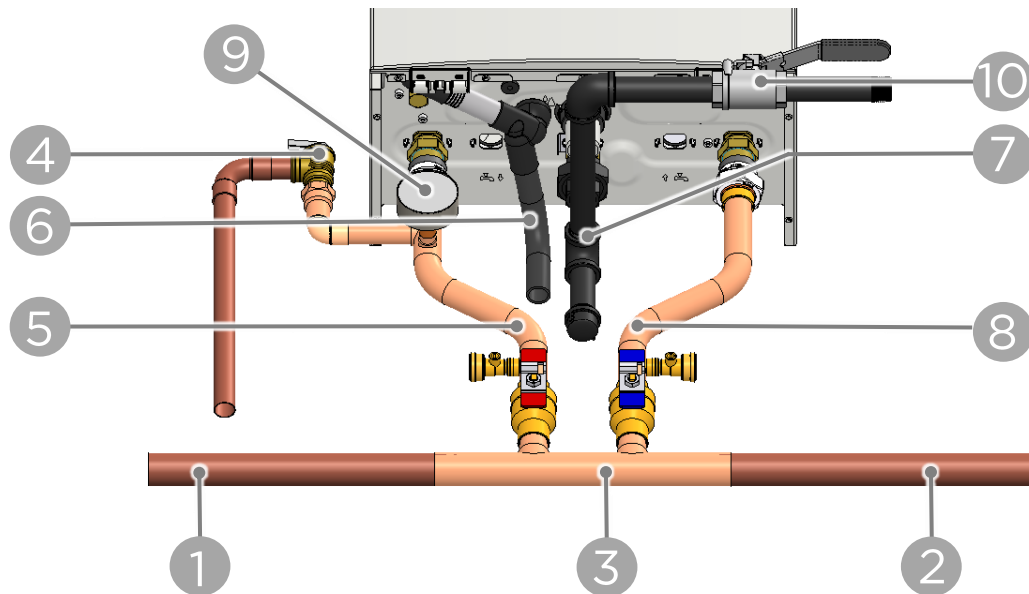

All items are field-supplied unless otherwise noted.

- |  |  |
|--|--|
| 1. Supply to CH System                             | 6. Condensate Drain  |
| 2. Return from CH System                           | 7. Gas Supply  |
| 3. Primary-Secondary Heating Kit                   | 8. CH Return   |
| 4. CH Pressure Relief Valve (supplied with boiler) | 9. Central Heating Temperature Pressure Gauge (supplied with boiler) |
| 5. CH Supply                                       | 10. Gas Shut Off Valve   |
|  | 11. Boiler Pump  |

## 3.3 Components

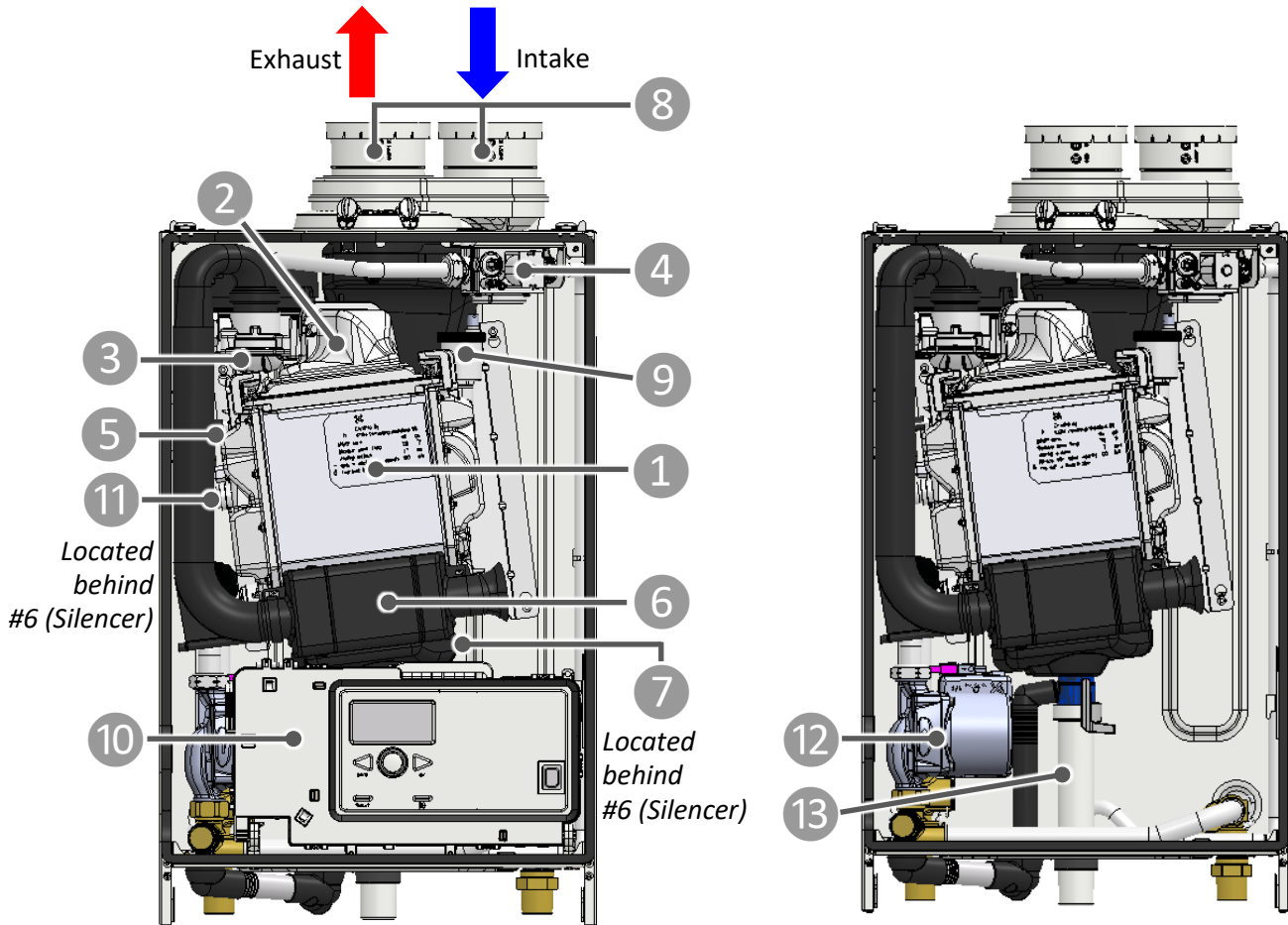

1	iCon Heat Exchanger
2	Burner Hood with Burner Cassette
3	Fan with Integrated Venturi
4	Gas Valve
5	Ignition Unit
6	Silencer
7	Condensate Tray

8	Flue Gas Exhaust/Air Intake with Measuring Points
9	Automatic De-aerator
10	Control Panel
11	Pressure Sensor
12	Modulating Pump
13	Condensate Trap

## 3.4 Specifications

Model		M060S	M090S	M120S	M160S
Dimensions - w, h, d		17 in. x 28 in. x 10 in. (439 mm x 699 mm x 264 mm)			
Weight		64 lb (29 kg)		70 lb (32 kg)	
Appliance Type		Wall-Mounted, Gas-Fired Solo Boiler			
Installation Type		Indoor			
Ignition System		Direct Electronic Ignition			
Heat Exchanger Type		iCon1		iCon2	
Heat Exchanger Surface Area		7.3 sq ft		11.8 sq ft	
Temperature Setting (Min - Max)		68°F - 185°F (20°C - 85°C)			
Water Content		1 Gallon 3.8 Liters	1 Gallon 3.8 Liters	1.4 Gallons 5.2 Liters	1.4 Gallons 5.2 Liters
Gas Consumption (Btu/h)	Minimum	NG: 17,000 LP: 31,500		NG: 23,500 LP: 73,500	
	Maximum	60,000	90,000	120,000	160,000
Water Supply Pressure	Central Heating	Minimum: 14 PSI		Maximum: 45 PSI	
	Pressure Relief Valve	30 PSI			
Pump Model		UPER 15-78			
Sound Level		39 dB	42 dB	48 dB	54 dB
Electrical Data	Normal	155 W	177 W	164 W	191 W
	Standby	3.5 W			
	Max Current	1.62 Amps	1.8 Amps	1.67 Amps	1.97 Amps
	Fuse	5 Amps			
Gas Supply Pressure	Natural Gas	3.0 in. - 10.5 in. W.C.			
	Propane	8.0 in. - 13.5 in. W.C.			
Electric Connections		AC 120 Volts, 60Hz.			
Energy Star Qualified		Recognized as the Most Efficient of ENERGY STAR®			
Certifications		ANSI Z21.13, CSA 4.9			

<sup>1</sup> Minimum flow may vary slightly depending on the temperature setting and the inlet water temperature. Minimum activation flow is 0.4 GPM (1.5 L/min).

<sup>2</sup> The maximum gas supply pressure must not exceed the value specified by the manufacturer.

Rinnai products are continually being updated and improved; therefore, specifications are subject to change without prior notice.

# 3.5 Dimensions

Measurements: in. (mm)

### Front

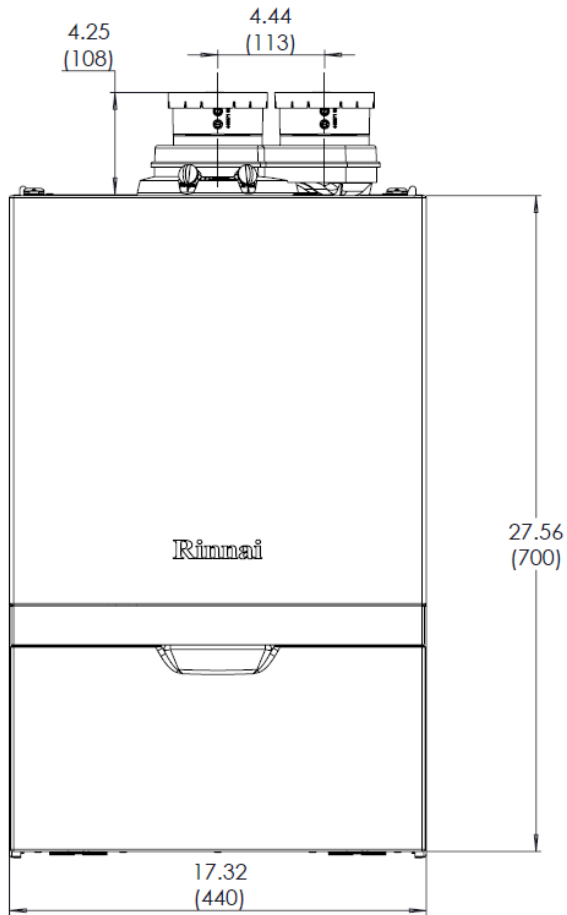

### Side

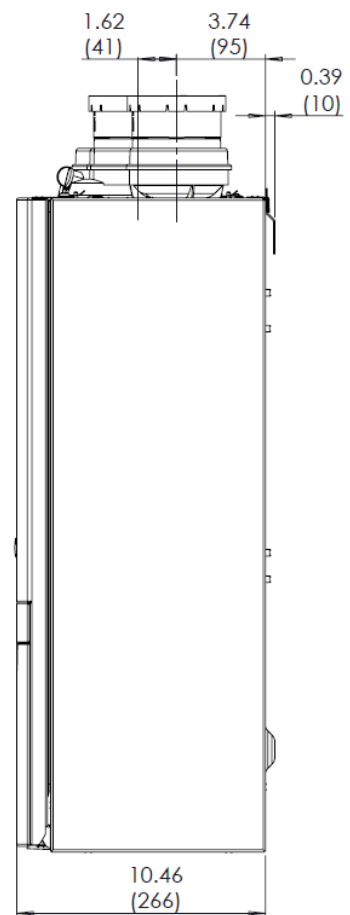

**Vent Top Connections:** 3 in. (80 mm) PP, 3 in. PVC, 3/5 in. Concentric, 2 in. (60 mm) PP, 2 in. PVC

### 3.5.1 Supply Connections

---

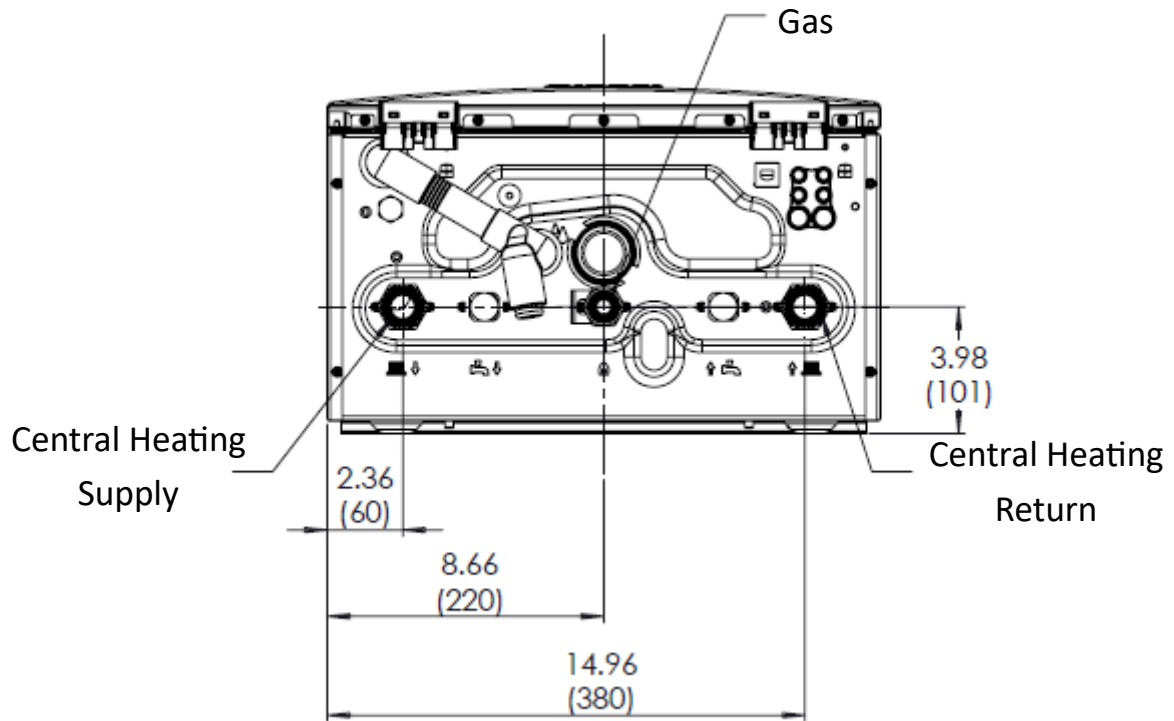

Connection	Connection Size with Provided Adapters
Gas	3/4 in. NPT
CH In (CH Return)	1 in. NPT
CH Out (CH Supply)	1 in. NPT



## 3.6 Accessories

The following optional accessories are available for the Rinnai M-Series Condensing Boiler.

### CONDENSATE NEUTRALIZER

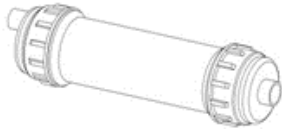

Neutralizes the condensate generated by the boiler.

### SCALECUTTER

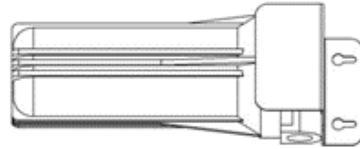

Filters and reduces the amount of scale entering the boiler allowing for greater boiler longevity.

### SCALECUTTER REFILL CARTRIDGE

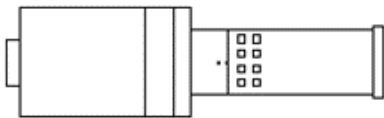

Refill cartridge for the ScaleCutter filter assembly.

### BOILER TOOLKIT

PN 809000024



Set of specific tools recommended for boiler service.

### Primary Secondary Heating Kit

PN 803000023

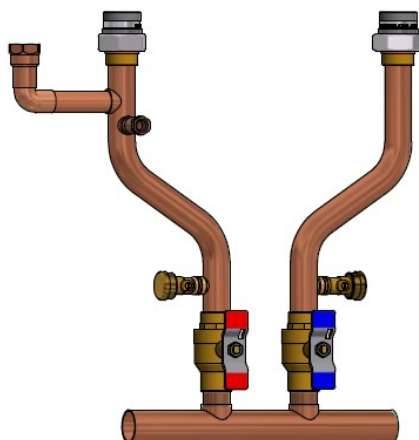

## 3.7 How to Remove the Front Panel

### ➔ IMPORTANT

Do not operate the boiler without the front panel installed. The front panel should only be removed for service/maintenance or replacing internal components.

#### You Will Need:

- Philips head screwdriver

- 1 Using a Philips head screwdriver, remove the 2 screws from the top of the boiler.

### ➔ TIP

Be careful not to lose the screws. You'll need them when reinstalling the front cover.

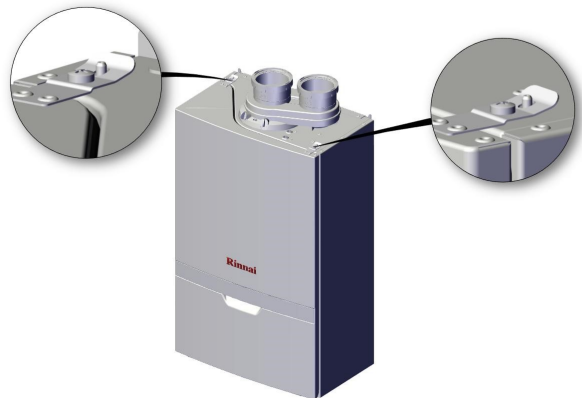

- 2 Lift the tab slightly above the peg.

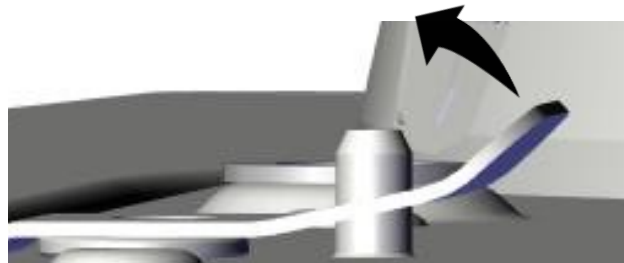

- 3 To remove, carefully lift the panel up and off to release it from the boiler.

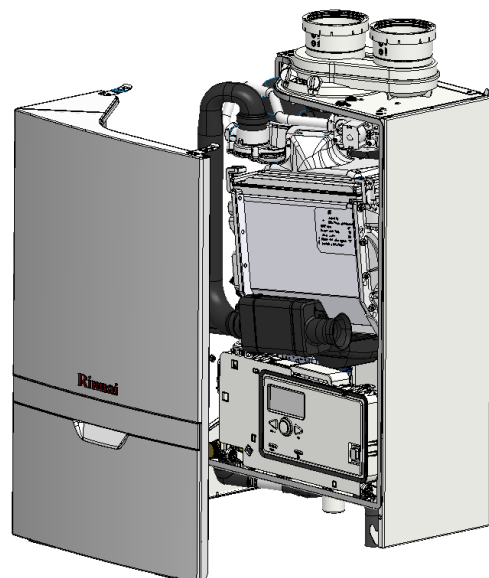

# 4 Installation

## Topics in this section

- Installation Guidelines
- What You'll Need
- Items Included
- Choose an Installation Location
- Mount the Boiler to the Wall
- Fill the Condensate Collector

### THIS SECTION IS INTENDED FOR THE INSTALLER

Installer qualifications: A trained and qualified professional must install the appliance, inspect it, and leak test the boiler before use. The warranty will be voided due to any improper installation. The trained and qualified professional should have skills such as: Gas sizing; Connecting gas lines, water lines, valves, and electricity; Knowledge of applicable national, state, and local codes; Installing venting through a wall or roof; and training in installation of condensing boilers. Training for Rinnai Condensing Boilers is accessible online at [www.trainingevents.rinnai.us](http://www.trainingevents.rinnai.us).





## 4.1 Installation Guidelines

- This boiler is certified for installation in residential and commercial applications.
- This boiler is suitable for combination water heating through an indirect tank and central heating.
- The installation must conform with local codes or, in the absence of local codes, with the *National Fuel Gas Code, ANSI Z223.1/NFPA 54*, or the *Natural Gas and Propane Installation Code, CSA B149.1*. If installed in a manufactured home, the installation must conform with the *Manufactured Home Construction and Safety Standard, Title 24 CFR, Part 3280* and/or *CAN/SCA Z240 MH Series, Mobile Homes*.
- The appliance, when installed, must be electrically grounded in accordance with local codes or, in the absence of local codes, with the *National Electrical Code, ANSI/NFPA 70*, or the *Canadian Electrical Code, CSA C22.1*.
- The appliance and its main gas valve must be disconnected from the gas supply piping system during any pressure testing of that system at test pressures in excess of 1/2 psi (3.5 kPa) (13.84 in W.C.). For system testing at pressures less than or equal to 1/2 psi (3.5 kPa) (13.84 in W.C.) the appliance must be isolated from the gas supply piping by closing its individual manual shutoff valve.
- You must follow the installation instructions and those in section "5. Venting" for adequate combustion air and exhaust.
- Should overheating occur or the gas supply fail to shut off, turn off the manual gas control valve to the appliance.
- Combustion air must be free of chemicals, such as chlorine or bleach, that produce fumes. These fumes can damage components and reduce the life of your appliance.
- Where required by the authority having jurisdiction, the installation must comply with the Standard for Controls and Safety Devices for Automatically Fired Boilers, ANSI/ASME CSD-1.

- Ensure the wall is of sufficient strength to support the weight of the boiler, piping and any other components needed for installation; if it is not, please reinforce the wall as appropriate.
- Operating limits of the boiler:

Maximum boiler set point temperature:	185°F (85°C)
Maximum operating pressure:	45 psi (3.1 bar)
Maximum allowable working temperature ASME:	210°F (99°C)
Maximum allowable working pressure ASME:	45 psi (3.1 bar)

#### DO NOT

-  DO NOT install the boiler in an area where water leakage of the unit or connections will result in damage to the area adjacent to the appliance or to lower floors of the structure. When such locations cannot be avoided, it is required that a suitable drain pan, adequately drained, be installed under the boiler. The pan must not restrict combustion air flow.
-  DO NOT install the boiler in an area with negative air pressure.
-  DO NOT obstruct the flow of combustion and ventilation air.
-  DO NOT use substitute parts that are not authorized for this boiler.
-  DO NOT install the boiler on carpeting.

## 4.2 What You'll Need

Gather the recommended tools and parts before starting installation.

### Items Needed

- Low loss header or closely spaced tee
- Expansion tank for a closed heating system
- CH System Air Separator
- Standard tools for central heating, gas fitting, plumbing and electrical wiring.
- Combustion analyzer (intended for use with condensing boilers)
- Digital manometer capable of reading both positive and negative pressure
- Digital multimeter capable of reading microamps
- pH digital meter or test strips
- For wall mounting bracket installation:
  - Level
  - Screws (use appropriate screws for type of wall construction)

### Other Items You May Need

- Hand truck with fastening belt
- Boiler toolkit (optional accessory for boiler service. See section "3.6 Accessories" for more information.)

# 4.3 Items Included

Carefully unpack your boiler system and verify the following contents are included. If any items are damaged or missing, contact your local dealer/distributor. Do not attempt to use any item that appears damaged.

**RINNAI CONDENSING BOILER**

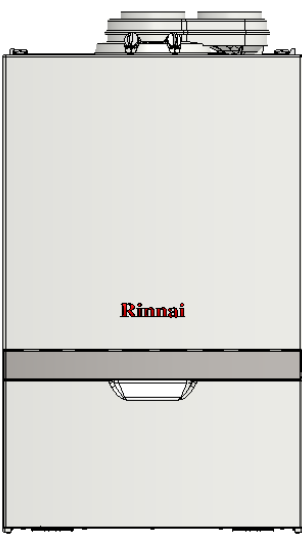

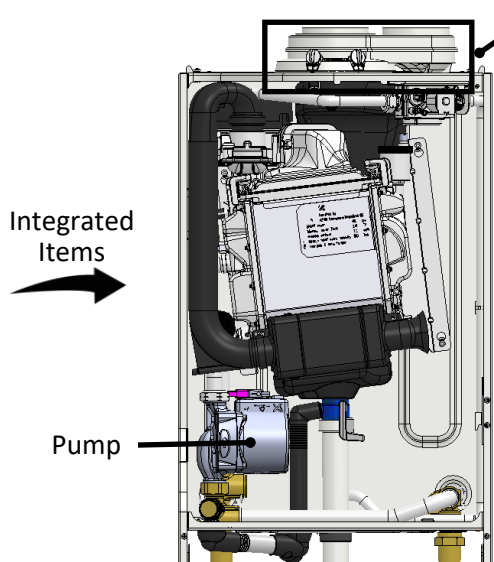





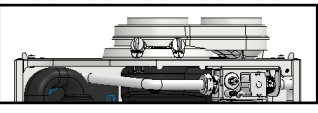





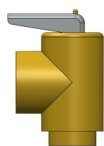
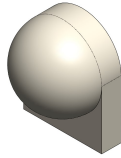

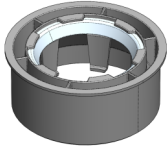
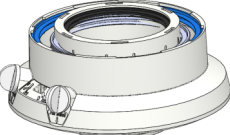
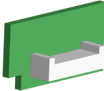

Integrated Items

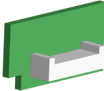
Pump

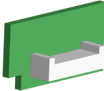

Vent top with integrated 3 in. PP (80 mm) Connections

*Refer to section "3.3 Components" for a complete list of integrated parts.*

<p><b>WALL MOUNTING BRACKET</b></p> 	<p><b>30 PSI PRESSURE RELIEF VALVE</b></p> <p>For Central Heating Systems</p> 	<p><b>OUTDOOR TEMPERATURE SENSOR</b></p> 	<p><b>CENTRAL HEATING TEMPERATURE PRESSURE GAUGE</b></p> 								
<p><b>VENT ADAPTERS</b></p> <div style="display: flex; justify-content: space-around;"> <div style="text-align: center;">  <p>3 in. PVC (QTY 2)</p> </div> <div style="text-align: center;">  <p>2 in. PVC/PP Reducer (QTY 2)</p> </div> </div> <div style="text-align: center; margin-top: 20px;">  <p>3/5 in. Concentric</p> </div>	<p><b>LIQUID PROPANE FIELD CONVERSION KIT</b></p> <p>This boiler is configured for Natural Gas only. Use this kit to convert to Propane Gas if needed. Contents include:</p> <table style="width: 100%; text-align: center;"> <tr> <td><b>EEPROM KEY</b></td> <td><b>LIQUID PROPANE RESTRICTOR</b></td> <td><b>CONVERSION RATING PLATE</b></td> <td><b>CONVERSION MANUAL</b></td> </tr> <tr> <td></td> <td></td> <td></td> <td></td> </tr> </table>			<b>EEPROM KEY</b>	<b>LIQUID PROPANE RESTRICTOR</b>	<b>CONVERSION RATING PLATE</b>	<b>CONVERSION MANUAL</b>				
<b>EEPROM KEY</b>	<b>LIQUID PROPANE RESTRICTOR</b>	<b>CONVERSION RATING PLATE</b>	<b>CONVERSION MANUAL</b>								
											
<p><b>DOCUMENTATION</b></p> <ul style="list-style-type: none"> <li style="width: 50%;">• Installation and Operation Manual (this manual)</li> <li style="width: 50%;">• ISCL</li> <li style="width: 50%;">• User Manual</li> <li style="width: 50%;">• Conversion Manual</li> </ul>											

## 4.4 Choose an Installation Location

When choosing an installation location, you must ensure that clearances will be met and that the vent length will be within required limits. Consider the installation environment, water quality, and need for freeze protection. Requirements for the gas line, water lines, electrical connection, and condensate disposal can be found in their respective installation sections in this manual.

This section provides information on the importance of water quality to the Rinnai Condensing Boiler. The information is intended to serve as general guidelines only and is not a complete list of water quality guidelines.

### 4.4.1 Water Quality Guidelines

Consideration of care for your boiler should include evaluation of water quality.

- The water must be potable, free of corrosive chemicals, sand, dirt, or other contaminants.
- It is up to the installer to ensure the water does not contain corrosive chemicals or elements that can affect or damage the boiler.
- Water that contains chemicals exceeding the levels below can damage the boiler.

Contaminant	Maximum Level
Total Hardness	Up to 200 mg/L
Aluminum *	Up to 0.2 mg/L
Chlorides *	Up to 250 mg/L
Copper *	Up to 1.0 mg/L
Dissolved Carbon Dioxide (CO <sub>2</sub> )	Up to 15.0 mg/L
Iron *	Up to 0.3 mg/L
Manganese *	Up to 0.05 mg/L
pH *	6.5 to 8.5
TDS (Total Dissolved Solids) *	Up to 500 mg/L
Zinc *	Up to 5 mg/L

\* Source: Part 143 National Secondary Drinking Water Regulations

- Unsuitable heating system water can cause the formation of scale or sludge, which affects system efficiency. It can also cause corrosion and reduce life of the heat exchanger.
- Never use water that has been treated by a reverse osmosis, deionized, or distilled water to soften the water to fill the heating system.
- Oxygen permeable or rubber tubing is not permitted in the heating system unless it is separated from the boiler by a plate heat exchanger. Boiler warranty may be voided if connected directly to CH systems that include this tubing.
- Thoroughly flush the system prior to filling. While flushing, isolate the boiler.
- Do not introduce any system cleaner into the boiler. Flush the system thoroughly to remove all system cleaner before filling the boiler with water.
- When freeze protection of the heating system is desired, only use Rinnai-approved antifreezes. The allowed maximum concentration is 40%.
- Reference section “14.1 Approved Cleaners, Inhibitors and Antifreezes” in the Appendix for an approved list of system cleaners, inhibitors, and antifreezes.

#### IMPORTANT

Replacement of components due to water quality damage is not covered by the warranty.

## 4.4.2 Environment

Air surrounding the boiler, venting, and vent termination(s) is used for combustion and must be free of any compounds that cause corrosion of internal components. These include corrosive compounds that are found in aerosol sprays, detergents, bleaches, cleaning solvents, oil based paints/varnishes, and refrigerants. The air in beauty shops, dry cleaning stores, photo processing labs, and storage areas for pool supplies often contains these compounds. The boiler, venting, and vent termination(s) should not be installed in any areas where the air may contain these corrosive compounds.

## 4.4.3 Clearances

Location	Clearance
<b>Top</b>	2 in. (51 mm) <i>0 in. from vent components</i>
<b>Bottom (Ground)</b>	12 in. (305 mm)
<b>Front</b>	6 in. (152 mm) <i>Clearance for servicing is 24 in. (610 mm) in front of boiler</i>
<b>Back</b>	0 in.
<b>Sides (Left and Right)</b>	2 in. (51 mm)
<b>Vent</b>	0 in.

*Right image is not to scale and is for illustration purposes only.*

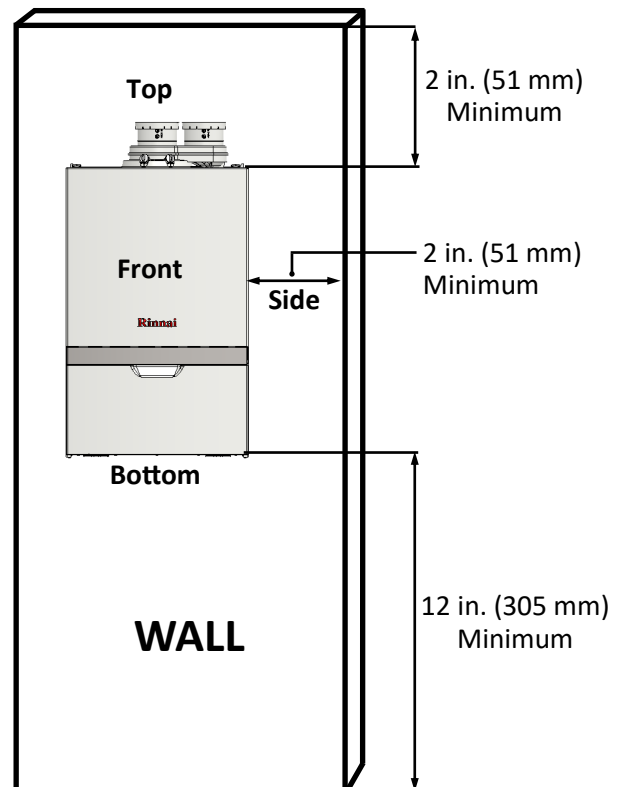

## 4.4.4 Installation Location Checklist

Use this checklist to ensure you have selected the correct location for the boiler.

<input type="checkbox"/>	The boiler is not exposed to corrosive compounds in the air.
<input type="checkbox"/>	The boiler location complies with the required clearances.
<input type="checkbox"/>	The planned combustion air and exhaust termination locations meet the required clearances.
<input type="checkbox"/>	The water supply does not contain chemicals or exceed total hardness that will damage the heat exchanger.
<input type="checkbox"/>	A standard 3 prong 120 VAC, 60 Hz properly grounded wall outlet or other 120 VAC, 60 Hz source is available.
<input type="checkbox"/>	The installation must conform with local codes or, in the absence of local codes, with the <i>National Fuel Gas Code, ANSI Z223.1/NFPA 54</i> , or the <i>Natural Gas and Propane Installation Code, CSA B149.1</i> .

## 4.5 Mount the Boiler to the Wall

### You Will Need:

- Rinnai Condensing Boiler
- Wall Mounting Bracket
- Boiler Mounting Template

### Supplied by Installer:

- Level
  - Four screws for mounting bracket installation
  - Screws for top and bottom bracket installation
- Use appropriate screws for type of wall construction.*

### Instructions:

1. Hold the wall mounting bracket up against the wall and use a level to make sure the bracket is even. Proper operation requires the boiler to be level.



Wall Mounting Bracket

2. Use the appropriate screws for the wall construction to secure the mounting bracket to the wall (use any of the screw holes in the mounting bracket).



3. Insert the mounting lip of the boiler onto the wall mounting bracket. Make sure the wall mounting bracket is attached to the wall and can hold the weight of the boiler before you fully let go.

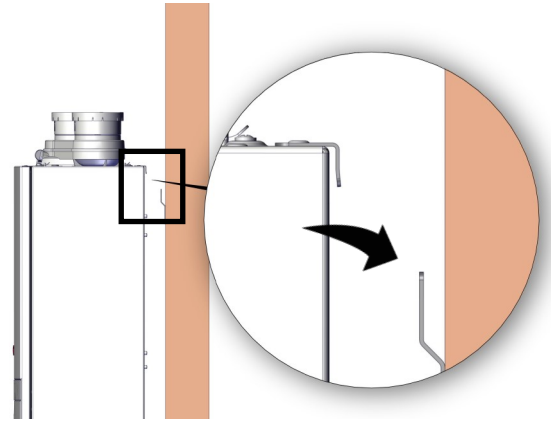

Boiler Mounting Template

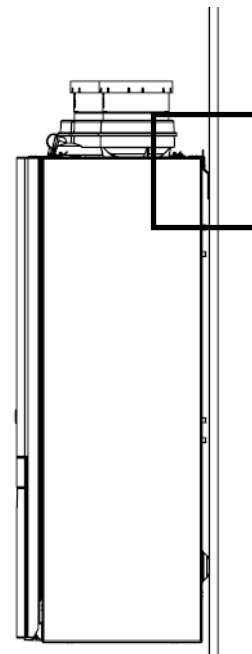

Assembled view



# 5

# Venting

## Topics in this section

- Guidelines
- Venting Installation Sequence
- Termination Considerations
- PVC Venting Safety Switch
- Venting Options

## 5.1 Guidelines

- M-Series boilers can be installed in direct vent or non-direct vent applications.
- When installed as Direct Vent, refer to the following section for a complete list of approved vent manufacturers and products: “5.4.1 Direct Vent: Approved Vent Manufacturers and Products.”
- When installed as Non-Direct Vent (Room Air), the vent must be Category IV and of a type listed by a national recognized testing agency.
- Exhaust must be directly vented to the outside. Combustion air can be provided from outside (Direct Vent) or from room air (Non-Direct Vent).
- If using room air (non-direct vent) for combustion, ensure the required volume of indoor air is available according to the National Fuel Gas Code, ANSI Z223.1/ NFPA 54.
- Avoid dips or sags in horizontal vent runs by installing supports per the vent manufacturer’s instructions.
- Support horizontal vent runs every 4 ft (1.2 m) and all vertical vent runs every 6 ft (1.83 m) or as per vent manufacturer’s instructions or local code requirements.

- Venting should be as direct as possible with a minimum number of pipe fittings.
- For manufactured vent systems, vent connections must be firmly pressed together so that the connections form an air tight seal. Follow the venting manufacturer’s instructions.
- Refer to the Schedule 40 PVC/CPVC manufacturer for appropriate fittings, solvents or joining methods.
- If venting reassembly is needed, follow the steps for installing the venting in the following sections. Make certain that the vent piping and seals are not damaged. Only use sealants, primers, or glues that are approved for the vent material in use.
- Refer to the instructions of the vent system manufacturer for component assembly instructions.
- If the vent system is to be enclosed, it is suggested that the design of the enclosure shall permit inspection of the vent system. The design of such enclosure shall be deemed acceptable by the installer or the local inspector.
- Any issues resulting from improper vent installation will not be covered by warranty.

### **WARNING**

- DO NOT use cellular core PVC/CPVC.
- DO NOT use Radel, ABS, or galvanized material to vent this appliance.
- DO NOT cover non-metallic vent pipe and fittings with thermal insulation.
- DO NOT combine vent components from different manufacturers.
- DO NOT reduce the vent diameter. Vent diameter cannot be less than 2 in.
- DO NOT connect the venting system with an existing vent or chimney.
- DO NOT common vent with the vent pipe of any other manufacturer’s boiler or appliance.

## 5.2 Venting Installation Sequence

1. Determine the termination method—horizontal or vertical, concentric, or twin pipes, etc.
2. Determine proper location for wall or roof penetration for each termination.
3. Install termination assembly as described in this manual or in the vent manufacturer's installation instructions.
4. Install air and vent piping from boiler to termination.
5. Slope horizontal exhaust run towards the boiler 1/4 in. per foot. DO NOT slope combustion air pipe towards boiler.
6. Install vent supports and brackets allowing for movement from expansion, or as per vent manufacturer's instructions or local code requirements.
7. *(Optional step)* Install vent screen or room air filter (not included with purchase) on Schedule 40 PVC combustion air and exhaust termination elbows as illustrated below.

### Vent Screen

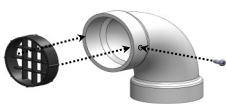

- Press vent screen inside of termination piece/elbow.
- Secure vent screen to the elbow with screw.

### Room Air Filter

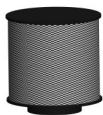

Press air filter into the 3 in. (80 mm) PP intake air fitting on the boiler.

## 5.3 Termination Considerations

Check to determine whether local codes supersede the following clearances:

- Avoid termination locations near a dryer vent.

- Avoid termination locations near commercial cooking exhaust.
- Avoid termination locations near any air inlets.
- You must install a vent termination at least 12 in above the ground or anticipated snow level.

The vent for this appliance shall not terminate:

- Over public walkways.
- Near soffit vents or crawl space vents or other area where condensate or vapor could create a nuisance or hazard or cause property damage.
- Where condensate or vapor could cause damage or could be detrimental to the operation of regulators pressure relief valves, or other equipment.

Listed below are important considerations for locating vent termination under a soffit (ventilated or unventilated or eave vent; or to a deck or porch):

- Do not install vent termination under a soffit vent such that exhaust can enter the soffit vent.
- Install vent termination such that exhaust and rising moisture will not collect under eaves. Discoloration to the exterior of the building could occur if installed too close.
- Do not install the vent termination too close under the soffit where it could present recirculation of exhaust gases back into the combustion air intake of the termination.

Horizontal portions of the venting system shall be supported to prevent sagging:

- For category IV boilers, have horizontal runs sloping upwards not less than 1/4 in. per foot (21 mm/m) from the boiler to the vent terminal;
- For category IV boilers, be installed so as to prevent accumulation of condensate; and
- For category IV boilers, where necessary, have means provided for drainage of condensate.

# 5.4 Venting Options

Two venting options are available: Direct Vent and Non-Direct Vent (Room Air).

**Option 1** Direct Vent (*Concentric and Twin Pipe*) See **Direct Vent** section for complete details.

### Concentric Pipe

Combustion air and exhaust vent directly through a single concentric connection. Hot exhaust exits through the interior tube, while combustion air enters through the outer layer.

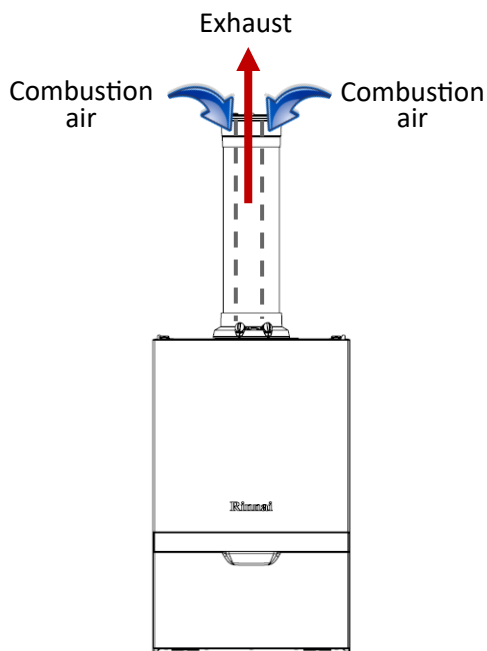

### Twin Pipe

Combustion air and exhaust vent directly through separate penetrations.

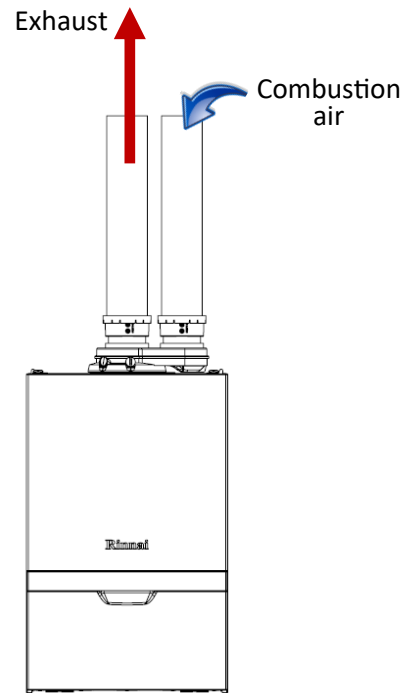

**Option 2** Room Air See **Room Air** section for complete details.

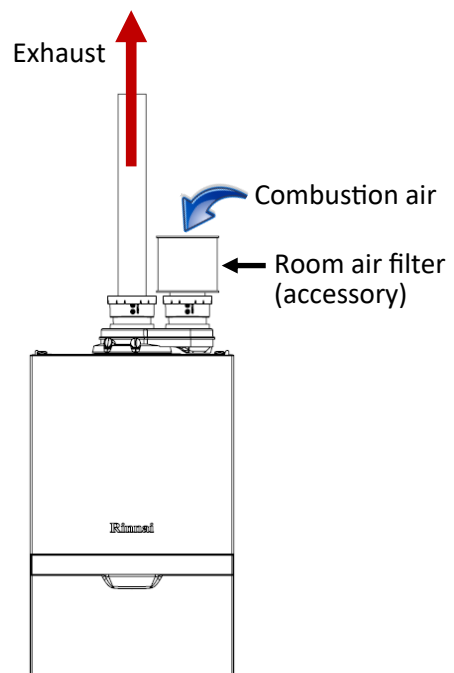
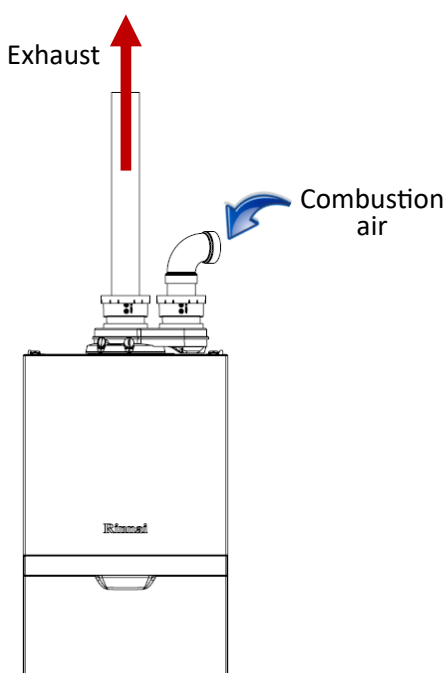















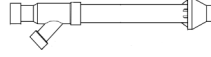

## 5.4.1 Direct Vent: Approved Vent Manufacturers and Products

Following is a list of vent components and terminations for Direct Vent installations (concentric and twin pipe). Install the correct venting for your model according to the venting manufacturer's instructions and the guidelines below. The information below is correct at time of publication and is subject to change without notice. Contact the vent manufacturer for questions related to the vent system, products, part numbers and instructions.









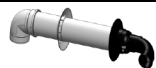

Manufacturer	Phone	Web Site
Ubbink	800-621-9419	www.rinnai.us
Centrotherm	877-434-3432	www.centrotherm.us.com
Heat-Fab	800-772-0739	www.heatfab.com
Metal Fab	800-835-2830	www.metal-fabinc.com
IPEX	U.S.: 800-463-9572 Canada: 866-473-9462	www.ipexamerica.com, www.ipexinc.com
DuraVent	800-835-4429	www.duravent.com
Royal	800-232-5690	www.royalbuildingproducts.com
ECCO Manufacturing	877-955-4805	www.eccomfg.com
DiversiTech	800-995-2222	www.diversitech.com
Z-FLEX	603-669-5136	www.z-flex.com





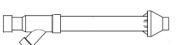

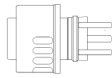



### 2 in./4 in. CONCENTRIC VENT TERMINATIONS

Manufacturer	Manufacturer Part Number	Product Description	Diagram	Horizontal	Vertical	Equivalent Length (ft)
<b>2 in./4 in. CONCENTRIC VENT TERMINATIONS</b>						
<b>UBBINK</b>	229011NPP 229012NPP 229013NPP	2/4 Condensing Horizontal Termination Kit 8.7 in. 2/4 Condensing Horizontal Termination Kit 12 in. 2/4 Condensing Horizontal Termination Kit 21 in.		✓		5
	224356NPP	2/4 Condensing Roof Discharge Termination 20 in. above roof			✓	5
	710202NPP	2/4 Condensing 90 Degree Diverter Nose (Use with Wall Terminal)		✓		5
	710215NPP	2/4 Condensing 45 Degree Diverter Nose (Use with Wall Terminal)		✓		5
<b>IPEX</b>	196005, 197040	FGV Concentric Vent Kit (16 in. length)		✓	✓	20
	196105, 197033	FGV Concentric Vent Kit (28 in. length)		✓	✓	20
	196125	FGV Concentric Vent Kit (40 in. length)		✓	✓	20











Manufacturer	Manufacturer Part Number	Product Description	Diagram	Horizontal	Vertical	Equivalent Length (ft)
<b>2 in./4 in. CONCENTRIC VENT TERMINATIONS (Continued)</b>						
<b>ROYAL</b>	52CVKGV6502	PVC Concentric Vent Kit 2 in. x 16 in.		✓	✓	20
	52CVKGV6502-28	PVC Concentric Vent Kit 2 in. x 28 in.		✓	✓	20
	52CVKGV6502-40	PVC Concentric Vent Kit 2 in. x 40 in.		✓	✓	20
<b>CENTROTHERM</b>	ICRT2439	2 in. x 4 in. Concentric Roof Termination			✓	20
<b>DURAVENT</b>	2PPS-VKL/VK-TCL	2 in. x 4 in. Vertical Termination Cap Kit-Concentric			✓	20
	2PPS-HKL	2 in. x 4 in. Horizontal Termination Kit-Concentric		✓		20
<b>ECCO</b>	190288	2 in. x 4 in. Concentric Horizontal Termination		✓		5
	190295	2 in. x 4 in. Concentric Vertical Termination			✓	5
<b>DIVERSITECH</b>	CVENT-2	2 in. x 4 in. Concentric Horizontal Termination		✓	✓	20
<b>Z-FLEX</b>	2ZDCTH24	2 in. x 4 in. Concentric Horizontal Termination		✓		5
	2ZDCTV24	2 in. x 4 in. Concentric Roof Termination			✓	5

### 3 in./5 in. CONCENTRIC VENT TERMINATIONS

Manufacturer	Manufacturer Part Number	Product Description	Diagram	Horizontal	Vertical	Equivalent Length (ft)
<b>3 in./5 in. CONCENTRIC VENT TERMINATIONS</b>						
<b>UBBINK</b>	223174PP 223176PP 223177PP	3/5 Condensing Horizontal Termination Kit 8.7 in. 3/5 Condensing Horizontal Termination Kit 12 in. 3/5 Condensing Horizontal Termination Kit 21 in.		✓		5
	223186PP	3/5 Condensing Horizontal Diverter Termination Kit 19 in.		✓		16
	224047PP	3/5 Condensing Raised Horizontal Termination Kit		✓		24
	184162PP	3/5 Condensing Roof Discharge Termination 20 in. above roof			✓	5
<b>IPEX</b>	196006, 197009	FGV Concentric Vent Kit 3 in. x 20 in.		✓	✓	20
	196106, 197107	FGV Concentric Vent Kit 3 in. x 32 in.		✓	✓	20
	196116, 197117	FGV Concentric Vent Kit 3 in. x 44 in.		✓	✓	20
<b>ROYAL</b>	52CVKGVS6503 (PVC)/ 52CVKGVSF9003 (CPVC)	PVC/CPVC Concentric Vent Kit 3 in. x 20 in.		✓	✓	20
	52CVKGVS6503-32 (PVC)/ 52CVKGVSF9003-32 (CPVC)	PVC/CPVC Concentric Vent Kit 3 in. x 32 in.		✓	✓	20
	52CVKGVS6503-44 (PVC)/ 52CVKGVSF9003-44 (CPVC)	PVC/CPVC Concentric Vent Kit 3 in. x 44 in.		✓	✓	20
<b>HEAT-FAB</b>	SC03HT	Horizontal Termination Adapter		✓		20
	SC03VT	Vertical Termination Adapter		✓		20
<b>CENTRO-THERM</b>	ICRT3539	3 in./5 in. Concentric Roof Termination PPs-UV			✓	20

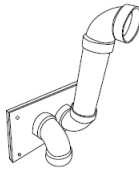









Manufacturer	Manufacturer Part Number	Product Description	Diagram	Horizontal	Vertical	Equivalent Length (ft)
<b>3 in./5 in. CONCENTRIC VENT TERMINATIONS (Continued)</b>						
<b>METAL-FAB</b>	3CGRLSV	Vertical Adapter			✓	1
	3CGRLSH	Horizontal Adapter		✓		6
	3CGRVT	Vertical Termination			✓	5
	3CGRHT	Horizontal Termination		✓		16
<b>DURAVENT</b>	3PPS-VKL/VK-TCL	3 in. x 5 in. Vertical Termination Cap Kit-Concentric			✓	20
	3PPS-HKL	3 in. x 5 in. Horizontal Termination Kit-Concentric		✓		20
<b>ECCO</b>	190388	3 in. x 5 in. Concentric Horizontal Termination		✓		5
	190395	3 in. x 5 in. Concentric Vertical Termination			✓	5
<b>DIVERSITECH</b>	CVENT-3	3 in. x 5 in. Concentric Horizontal Termination		✓	✓	20
<b>Z-FLEX</b>	2ZDCTH35	3 in. x 5 in. Concentric Horizontal Termination		✓		5
	2ZDCTV35	3 in. x 5 in. Concentric Roof Termination			✓	5

## 2 in. TWIN PIPE TERMINATIONS

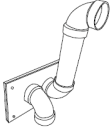

Manufacturer	Manufacturer Part Number	Product Description	Diagram	Horizontal	Vertical	Equivalent Length (ft)
<b>2 in. TWIN PIPE TERMINATIONS</b>						
<b>CENTROTHERM</b>	ISELL0287UV	2 in. 87° Long PPS-UV		✓		6
	ISTT0220	2 in. Termination Tee		✓		6
	ISLPT0202	2 in. Low Profile Wall Termination		✓		5
<b>DURAVENT</b>	2PPS-HTPL	2 in. Twin Pipe Termination		✓		10
	2PPS-HSTL	2 in. Single Horizontal Termination		✓		6
	2PPS-TBL	2 in. Black UV Resistant Tee		✓		5
<b>IPEX</b>	196984	FGV PVC Low Profile Termination Kit		✓		5
	081216	FGV PVC Wall Termination Kit		✓		16
<b>ROYAL</b>	52SWVKGVS6502	PVC Side Wall Vent Kits		✓		5
	52WTVKGVS6502	PVC Wall Vent Kits		✓		16
<b>DIVERSITECH</b>	HVENT-2	2 in. Low Profile Horizontal Vent Kit		✓		5



### 3 in. TWIN PIPE TERMINATIONS

Manufacturer	Manufacturer Part Number	Product Description	Diagram	Horizontal	Vertical	Equivalent Length (ft)
<b>3 in. TWIN PIPE TERMINATIONS</b>						
<b>CENTROTHERM</b>	ISELL0387UV	3 in. 87° Long PPS-UV		✓		6
	ISTT0320	3 in. Termination Tee		✓		6
	ISLPT0303	3 in. Low Profile Wall Termination		✓		5
<b>DURAVENT</b>	3PPS-HTPL	3 in. Twin Pipe Termination		✓		10
	3PPS-HSTL	3 in. Single Horizontal Termination		✓		5
	3PPS-TBL	3 in. Black UV Resistant Tee		✓		6
<b>IPEX</b>	196985	FGV PVC Low Profile Termination Kit		✓		5
	081219	FGV PVC Wall Termination Kit		✓		16
<b>ROYAL</b>	52SWVKGVS6503	PVC Side Wall Vent Kits		✓		5
	52WTVKGVS6503	PVC Wall Vent Kits		✓		16
<b>DIVERSITECH</b>	HVENT-3	3 in. Low Profile Horizontal Vent Kit		✓		5

## VARIOUS 2 in. OR 3 in. SCHEDULE 40 PVC/CPVC TERMINATIONS

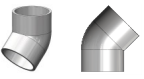
Product Description	Diagram	Horizontal	Vertical	Equivalent Length (ft)
Air Filter Screen		✓	✓	N/A
Tee		✓	✓	5
90° Elbow		✓	✓	5
45° Elbow		✓	✓	2.5

### Approved PVC/CPVC Vent and Air Piping Material

Item	Material	Standard for Installation in North America	
		United States	Canada
<b>Thermoplastic Piping Materials</b>			
Vent or Combustion Air Intake Pipe and Fittings	PVC Schedule 40	ANSI/ASTM D1785	Thermoplastic vent pipe must be certified to ULC S636. Intake pipe may be of the materials listed in this table.
	PVC-DWV	ANSI/ASTM D2665	
	CPVC Schedule 40	ANSI/ASTM F441	
PVC Pipe Cement and Primer	PVC	ANSI/ASTM D2564	
	CPVC Schedule 40	ANSI/ASTM F493	
<b>PVC Vent Screens</b>			
Termination Vent Screens	Polyethylene	<ul style="list-style-type: none"> <li>• 2 in. Vent Screens (included in carton box) (IPEX Part Number: 196050)</li> <li>• 3 in. Vent Screens (IPEX Part Number: 196051)</li> </ul>	

Exhaust piping must be of solid core material. Refer to the PVC/CPVC manufacturer for appropriate fittings, solvents or joining methods.

## APPROVED VENTING MATERIALS BY MANUFACTURER

Manufacturer	Vent Material
Ubbink	PVC (Outer Vent), Polypropylene (Inner Vent)
Centrotherm	Polypropylene
Heat-Fab	Metal
Metal Fab	Metal
IPEX	PVC/CPVC
DuraVent	Polypropylene
Royal	PVC
ECCO Manufacturing	Polypropylene
DiversiTech	PVC/CPVC
Z-FLEX	Polypropylene

## 5.4.2 Direct Vent (Concentric and Twin Pipe): Termination Clearances

The information below applies to Concentric and Twin Pipe.

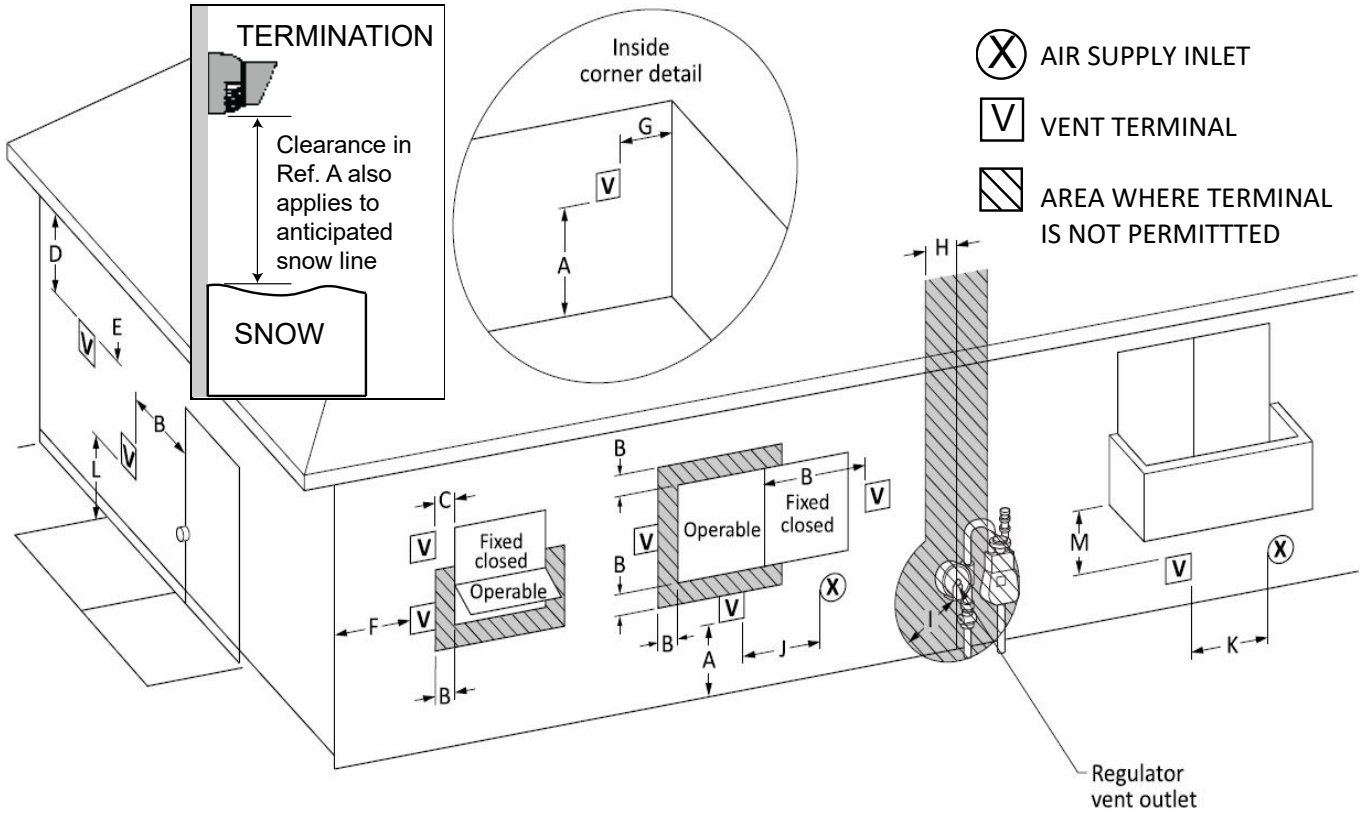

Ref	Description	Canadian Installations (CSA B149.1)	U.S. Installations (ANSI Z223.1 /NFPA 54)
		Direct Vent (Indoor Unit)	Direct Vent (Indoor Unit)
A	Clearance above grade, veranda, porch, deck, or balcony	12 in. (30 cm)	12 in. (30 cm)
B	Clearance to window or door that may be opened	36 in. (91 cm)	12 in. (30 cm)
C	Clearance to permanently closed window	*	*
D	Vertical clearance to ventilated soffit, located above the terminal within a horizontal distance of 2 ft (61 cm) from the center line of the terminal	*	*
E	Clearance to unventilated soffit	*	*
F	Clearance to outside corner	*	*
G	Clearance to inside corner	*	*
H	Clearance to each side of center line extended above meter/regulator assembly	*	*
I	Clearance to service regulator vent outlet	Above a regulator within 3 ft (91 cm) horizontally of the vertical center line of the regulator vent outlet to a maximum vertical distance of 15 ft (4 m)	*
J	Clearance to non-mechanical air supply inlet to building or the combustion air inlet to any other appliance	36 in. (91 cm)	12 in. (30 cm)
K	Clearance to a mechanical air supply inlet	6 ft (1.83 m)	3 ft (91 cm) above if within 10 ft (3 m) horizontally
L	Clearance above paved sidewalk or paved driveway located on public property	7 ft (2.13 m) [1]	*
M	Clearance under veranda, porch, deck, or balcony	12 in. (30 cm) [2]	*

**Clearance to opposite wall is 24 in. (60 cm).**

- [1] A vent shall not terminate directly above a sidewalk or paved driveway that is located between two single family dwellings and serves both dwellings.  
 [2] Permitted only if veranda, porch, deck, or balcony is fully open on a minimum of two sides beneath the floor.

\* Clearances are in accordance with local installation codes and the requirements of the gas supplier.

## 5.4.3 Direct Vent: Concentric Pipe

### Concentric Pipe: Termination Clearances

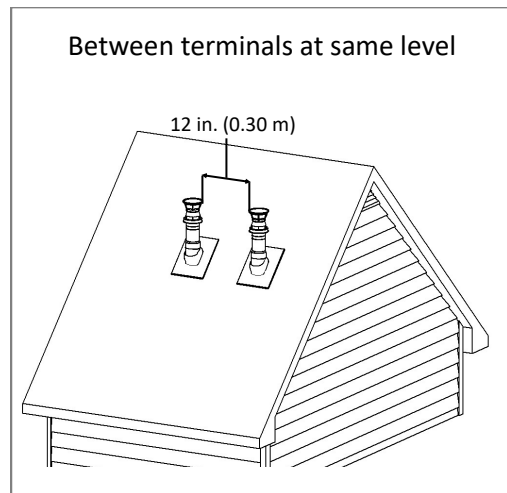
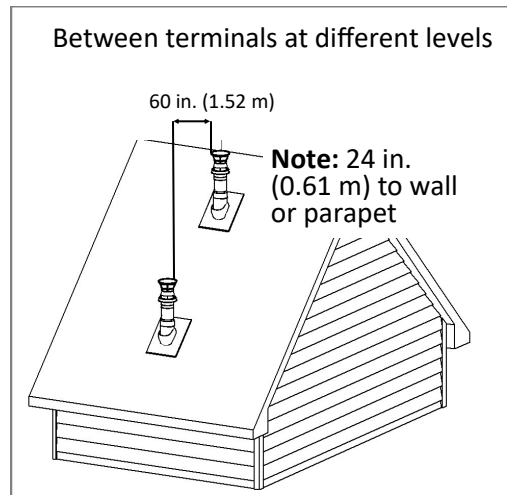
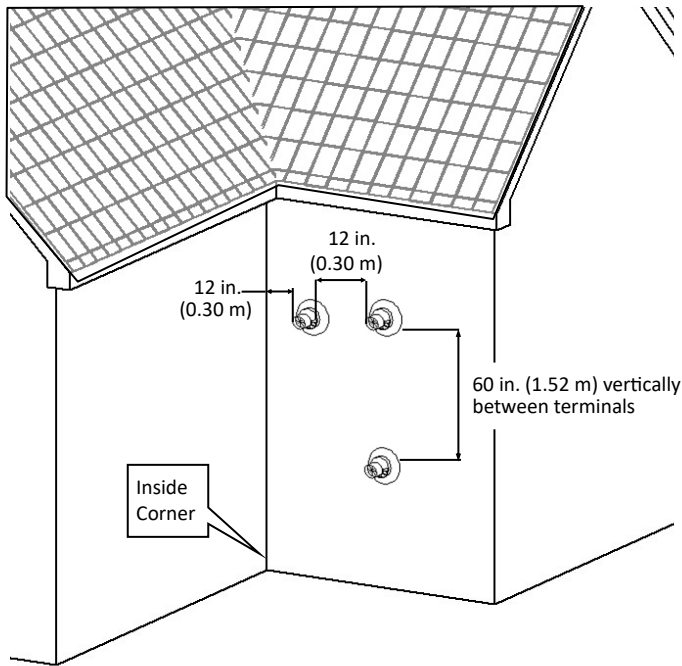

All terminations (horizontal and/or vertical) must terminate 12 in. (0.30 m) above grade or anticipated snow level.

### Concentric Pipe: Maximum Equivalent Vent Length

Vent Sizes	2 in. X 4 in.		3 in. X 5 in.	
Boiler Model Number	M060S, M090S	M120S, M160S	M060S, M090S	M120S, M160S
Vent Lengths	60 ft (18 m)	30 ft (9 m)	150 ft (46 m)	140 ft (43 m)
<ul style="list-style-type: none"> <li>• 45° elbow is equivalent to 3 ft (1 m)</li> <li>• 90° elbow is equivalent to 6 ft (2 m)</li> </ul>				

## Concentric Pipe: Installation Instructions

The instructions below apply to concentric vent sizes 2 in. x 4 in. and 3 in. x 5 in.

1. Remove the vent top (slightly twist counter-clockwise and pull up). Discard vent top if desired.

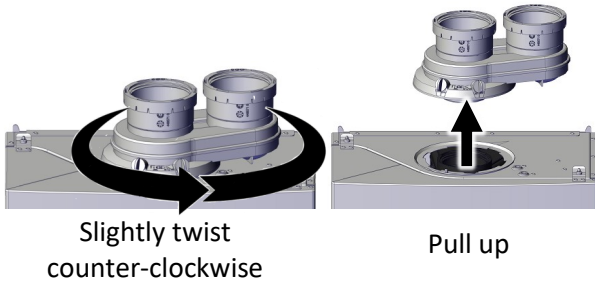

2. Insert the concentric adapter and rotate clockwise until locked in place.

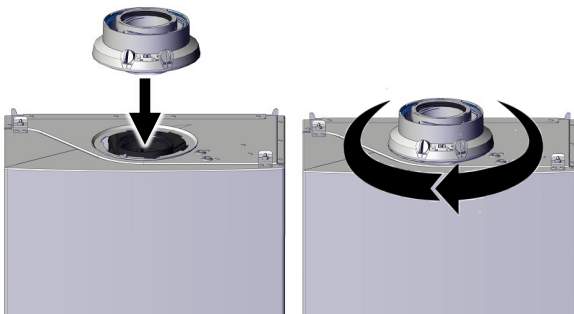

## Concentric Pipe: Example Vent Applications

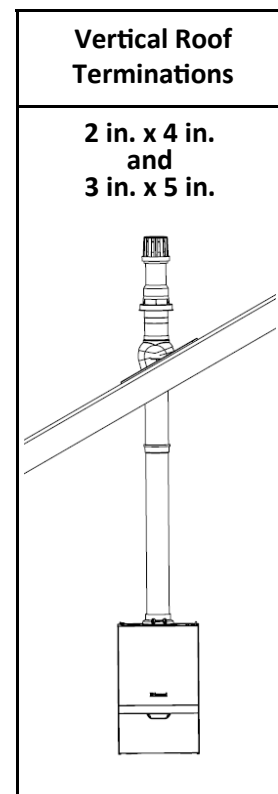
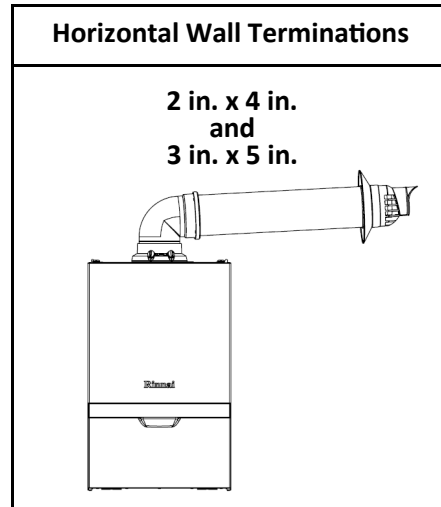

### ➔ IMPORTANT

Install the venting termination according to the diagrams and instructions in this manual. Slope the venting 1/4 in. per foot toward the appliance according to the vent manufacturer's installation instructions. Dispose of condensate per local codes.

## 5.4.4 Direct Vent: Twin Pipe

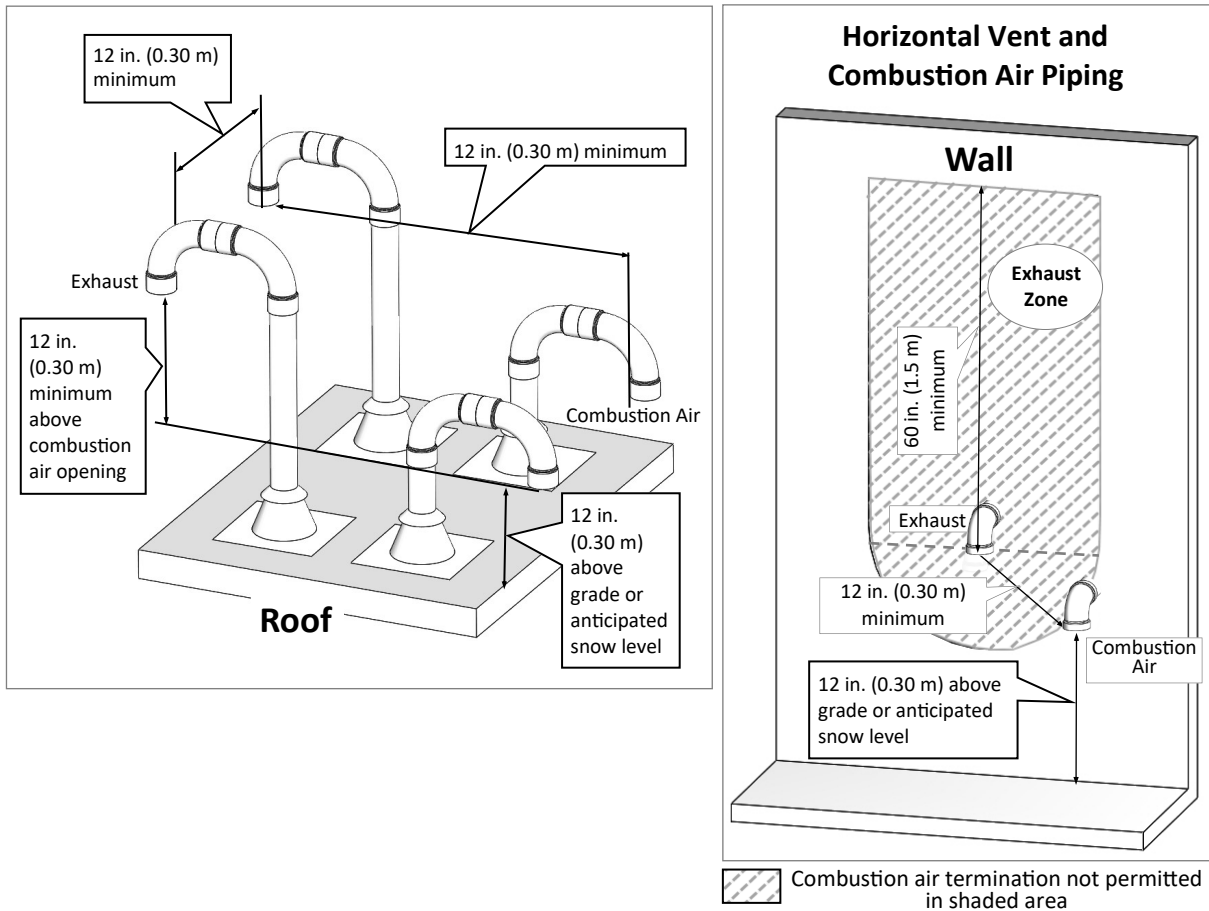

### Twin Pipe: Termination Clearances



### Twin Pipe: Maximum Equivalent Vent Length

Vent Sizes	<ul style="list-style-type: none"> <li>2 in. PVC</li> <li>2 in. (60 mm) PP</li> </ul>	<ul style="list-style-type: none"> <li>3 in. PVC</li> <li>3 in. (80 mm) PP</li> </ul>		
Boiler Model Number	M060C, M090S	M120S, M160S	M060S, M090S	M120S, M160S
Vent Lengths	60 ft (18 m)	30 ft (9 m)	150 ft (46 m)	140 ft (43 m)
<ul style="list-style-type: none"> <li>45° elbow is equivalent to 3 ft (1 m)</li> <li>90° elbow is equivalent to 6 ft (2 m)</li> </ul>				

Vent length includes the additional venting, fittings and terminations.

ACCEPTABLE	ACCEPTABLE	NOT ACCEPTABLE
90° Elbows, Long Sweep	90° Elbows, Short Sweep	90° Elbows, Close Turn
		

# Twin Pipe: Installation Instructions

This boiler is equipped with a 3 in. PVC pipe connection. With the use of a pipe reducer, installers can use a 2 in. pipe for the combustion air and exhaust.

## **⚠ WARNING**

**DO NOT** apply PVC glues, solvents, or cleaners to the boiler's combustion air or exhaust gasket connections. Failure to correctly assemble the components according to these instructions may result in property damage, personal injury, or death.

### ▶ **Install 3 in. (80 mm) Polypropylene (PP)**

- 1 Insert 3 in. (80 mm) PP piping.

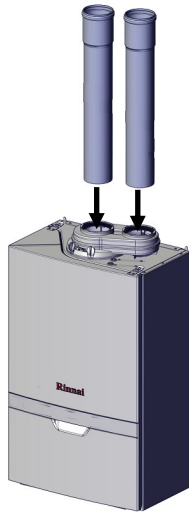

### ▶ **Install 2 in. PVC or PP (60 mm)**

- 1 Insert 3 in. PVC adapter. Insert 2 in. reducer.

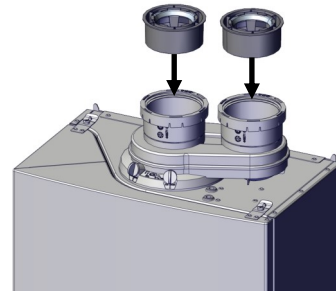

### ▶ **Install 3 in. PVC**

- 1 Insert the 3 in. PVC adapter onto the vent top.

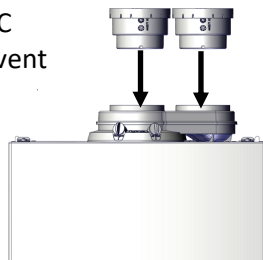

- 2 Insert 3 in. PVC piping.

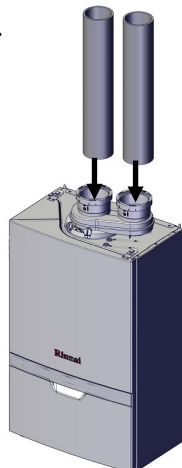



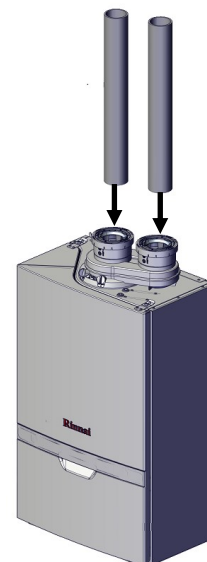

- 2 Install 2 in. PVC or PP piping.

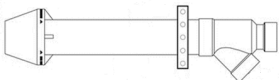

# Twin Pipe: Example Vent Applications

Slope horizontal exhaust 1/4 in. per foot towards the boiler. DO NOT slope combustion air pipe towards the boiler.

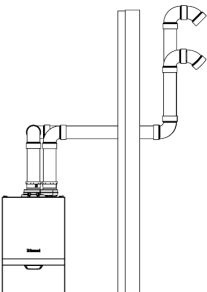
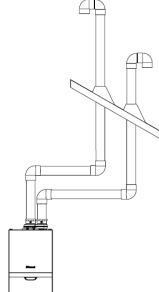
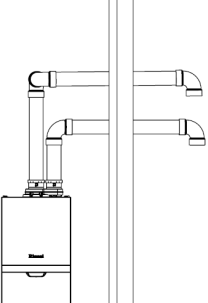
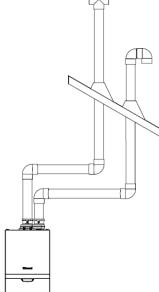
**CAUTION** Rinnai cautions against installing the boiler in applications with venting in different pressure planes. It is possible to have poor performance with this installation.

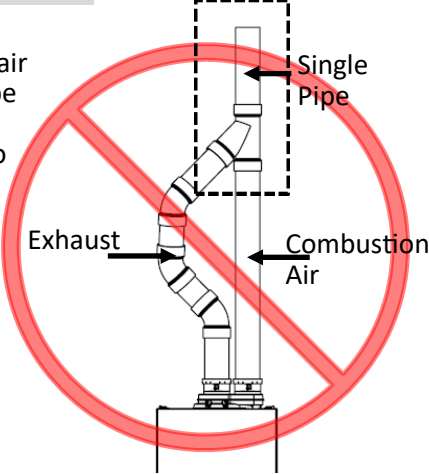
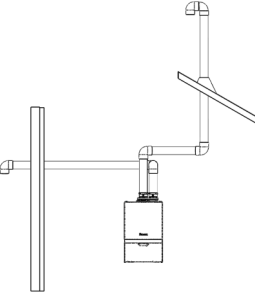
<p><b>This configuration requires the use of a Concentric Vent Termination.</b></p> <p>2 in. or 3 in. PVC/CPVC IPEX / Royal Concentric Side Wall Termination Configuration</p> 	<p><b>This configuration requires the use of a Concentric Vent Termination.</b></p> <p>2 in. or 3 in. PVC/CPVC IPEX / Royal Concentric Vertical Termination Configuration</p> 
<p>2 in. or 3 in. Schedule 40 PVC/CPVC Snorkel Termination Configuration</p> 	<p>2 in. or 3 in. Schedule 40 PVC/CPVC Standard Upside Down "U" Vertical Termination Configuration</p> 
<p>2 in. or 3 in. Schedule 40 PVC/CPVC Elbow or Tee Side Wall Termination Configuration</p>  <p>Tee not permissible for intake termination</p>	<p>2 in. or 3 in. Schedule 40 PVC/CPVC Tee Vertical Termination Configuration</p>  <p>Tee not permissible for intake termination</p>
<p>2 in. or 3 in. PVC Low Profile Termination Configuration</p> 	<p><b>WARNING</b></p> <p>Exhaust and combustion air <u>MUST NOT</u> be brought together into a single PVC pipe using a pipe fitting.</p>  <p>Single Pipe</p> <p>Exhaust</p> <p>Combustion Air</p>
<p>Unbalanced venting. Intake and exhaust terminated on different pressure planes.</p> 	



## 5.4.5 Non-Direct Vent (Room Air)

### Room Air: Termination Clearances

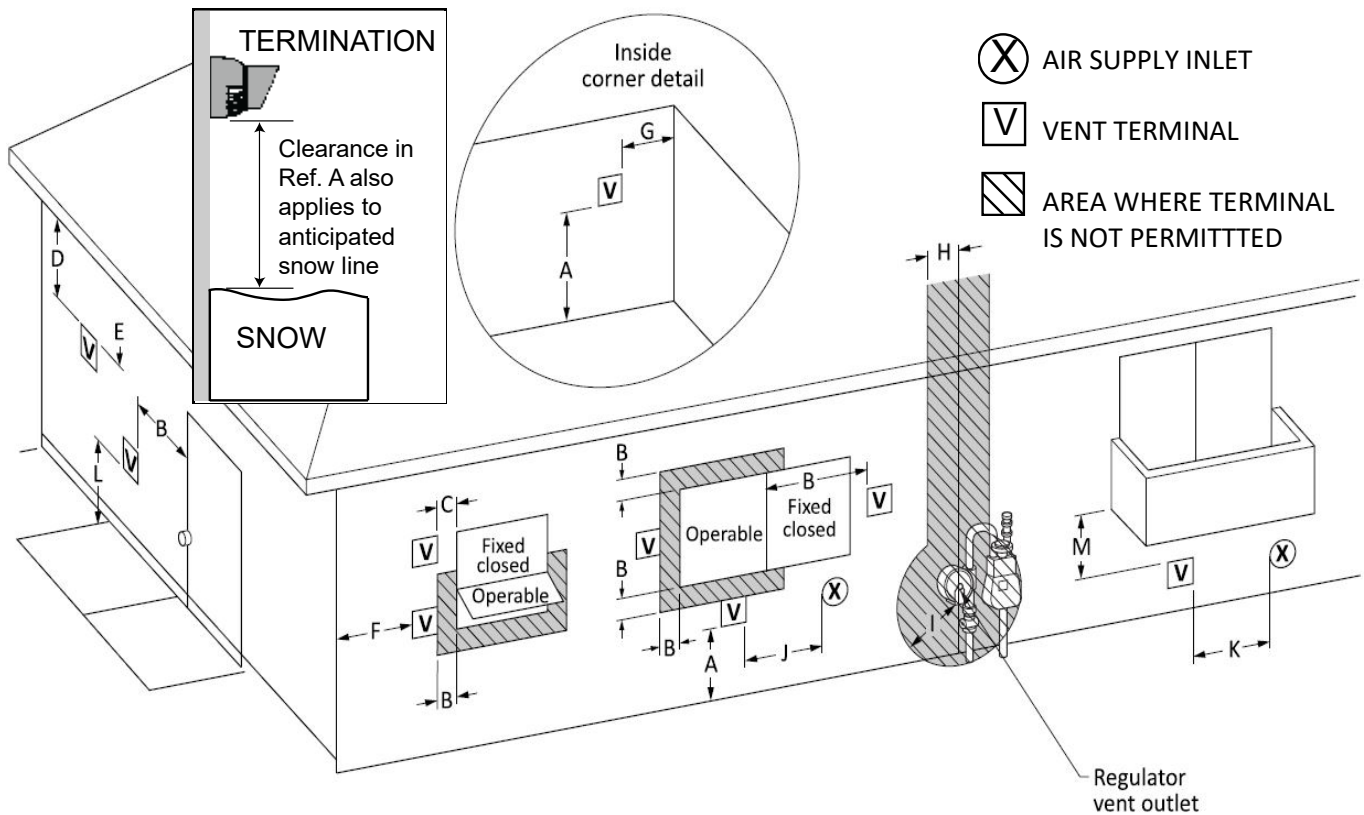

Ref	Description	Canadian Installations (CSA B149.1)	U.S. Installations (ANSI Z223.1 /NFPA 54)
		Other than Direct Vent (Room Air)	Other than Direct Vent (Room Air)
A	Clearance above grade, veranda, porch, deck, or balcony	12 in. (30 cm)	12 in. (30 cm)
B	Clearance to window or door that may be opened	36 in. (91 cm)	4 ft (1.2 m) below or to side of opening; 1 ft (300 mm) above opening
C	Clearance to permanently closed window	*	*
D	Vertical clearance to ventilated soffit, located above the terminal within a horizontal distance of 2 ft (61 cm) from the center line of the terminal	*	*
E	Clearance to unventilated soffit	*	*
F	Clearance to outside corner	*	*
G	Clearance to inside corner	*	*
H	Clearance to each side of center line extended above meter/regulator assembly	*	*
I	Clearance to service regulator vent outlet	Above a regulator within 3 ft (91 cm) horizontally of the vertical center line of the regulator vent outlet to a maximum vertical distance of 15 ft (4 m)	*
J	Clearance to non-mechanical air supply inlet to building or the combustion air inlet to any other appliance	12 in (30 cm) for appliances > 10,000 Btuh (3 kW) and ≤ 100,000 Btuh (30 kW), 36 in (91 cm) for appliances >100,000 Btuh (30 kW)	4 ft (1.2 m) below or to side of opening; 1 ft (300 mm) above opening
K	Clearance to a mechanical air supply inlet	6 ft (1.83 m)	3 ft (91 cm) above if within 10 ft (3 m) horizontally
L	Clearance above paved sidewalk or paved driveway located on public property	7 ft (2.13 m) [1]	7 ft (2.13 m)
M	Clearance under veranda, porch, deck, or balcony	12 in. (30 cm) [2]	*
<b>Clearance to opposite wall is 24 in. (60 cm).</b>			
[1] A vent shall not terminate directly above a sidewalk or paved driveway that is located between two single family dwellings and serves both dwellings.		* Clearances are in accordance with local installation codes and the requirements of the gas supplier.	
[2] Permitted only if veranda, porch, deck, or balcony is fully open on a minimum of two sides beneath the floor.			

## Room Air Vertical Termination of Multiple Boilers

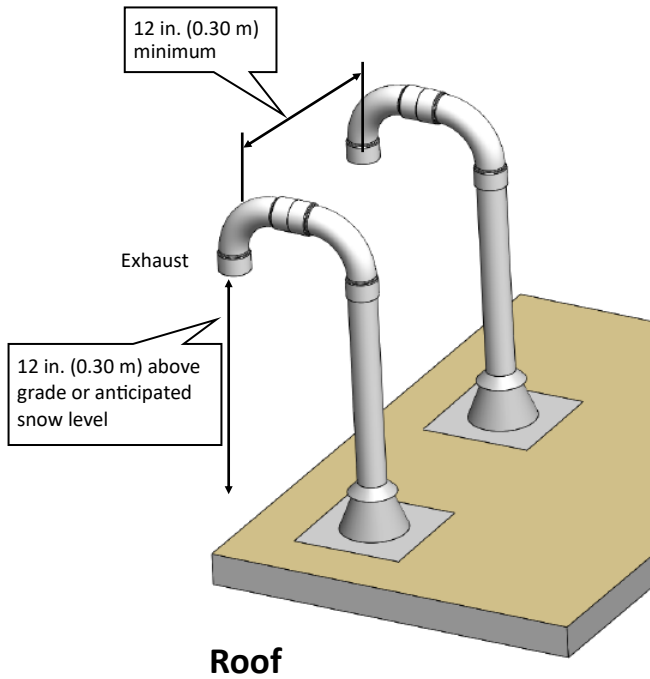

## Exhaust Termination Clearances for Internal (Indoor) Room Air Applications

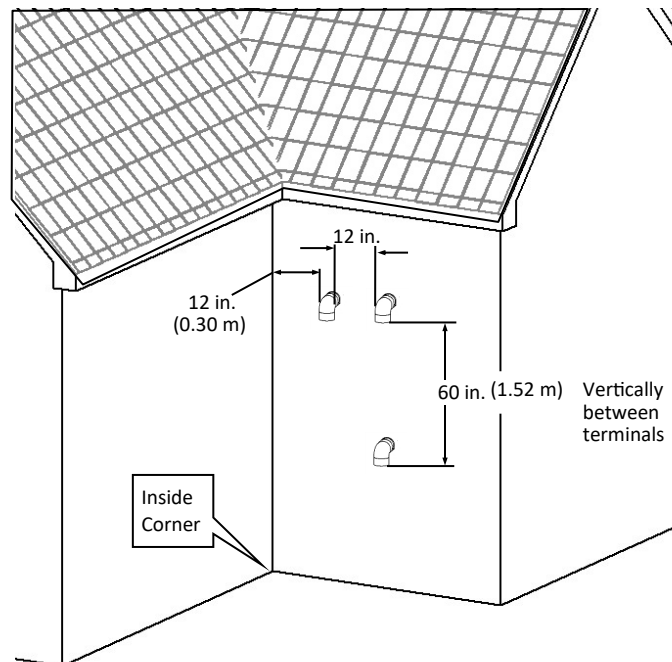

### ➔ IMPORTANT

- Installation of Room Air must use listed Category IV venting.
- All terminations (horizontal and/or vertical) must terminate 12 in. above grade or anticipated snow level.

## ROOM AIR: INSTALLATION INSTRUCTIONS

Insert air filter or elbow into 3 in. PVC intake air fitting.

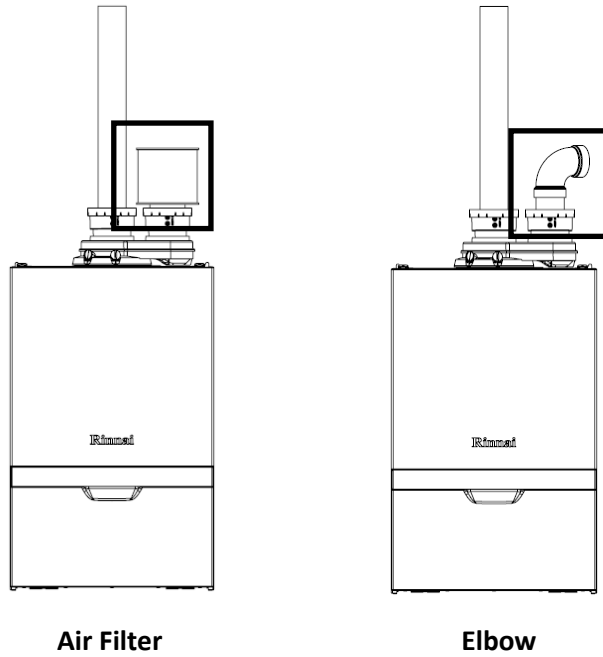

## Room Air: Maximum Equivalent Vent Length

Vent Sizes	<ul style="list-style-type: none"> <li>2 in. PVC</li> <li>2 in. (60 mm) PP</li> </ul>		<ul style="list-style-type: none"> <li>3 in. PVC</li> <li>3 in. (80 mm) PP</li> </ul>		2 in. (51mm) Ubbink Flex	
Boiler Model Number	M060S, M090S	M120S, M160S	M060S, M090S	M120S, M160S	M060S, M090S	M120S, M160S
Vent Lengths	60 ft (18 m)	30 ft (9 m)	150 ft (46 m)	140 ft (43 m)	60 ft (18 m)	30 ft (9 m)
<ul style="list-style-type: none"> <li>45° elbow is equivalent to 3 ft (1 m)</li> <li>90° elbow is equivalent to 6 ft (2 m)</li> </ul>						

Vent length includes the additional venting, fittings and terminations.

ACCEPTABLE	ACCEPTABLE	NOT ACCEPTABLE
90° Elbows, Long Sweep	90° Elbows, Short Sweep	90° Elbows, Close Turn

## Room Air: Combustion Air

### WARNING

- This boiler requires adequate combustion air for ventilation and dilution of flue gases. Failure to provide adequate combustion air can result in unit failure, fire, explosion, serious bodily injury or death. Use the following methods to ensure adequate combustion air is available for correct and safe operation of this boiler.
- Direct Venting is recommended in unusually tight buildings or in installation locations subject to significant negative air pressure.

### IMPORTANT

Combustion air must be free of corrosive chemicals. Do not provide combustion air from corrosive environments. Appliance failure due to corrosive air is not covered by warranty.

For applications containing corrosive indoor air, this appliance must be installed as direct vent. DO NOT use room air in applications where combustion air contains acid forming chemicals such as sulfur, fluorine and chlorine. These chemicals have been found to cause rapid damage and decay and can become toxic when used as combustion air in gas appliances. Such chemicals can be found in, but not limited to bleach, ammonia, cat litter, aerosol sprays, cleaning solvents, varnish, paint and air fresheners. Do not store these products or similar products in the vicinity of this boiler.

### Unconfined Space

An unconfined space is defined in *National Fuel Gas Code, ANSI Z223.1/NFPA 54* as "a space whose volume is not less than 50 cubic feet per 1000 Btu/hr (4.8 m<sup>3</sup> per kW per hour) of the aggregate input rating of all appliances installed in that space. Rooms communicating directly with the space in which the appliances are installed, through openings not furnished with doors, are considered a part of the unconfined space." If the "unconfined space" containing the appliance(s) is in a building with tight construction, additional outside air may be required for proper operation. Outside air openings should be sized the same as for a confined space.

### Confined Space

A confined space is defined in the *National Fuel Gas Code, ANSI Z223.1/NFPA 54* as "a space whose volume is less than 50 cubic feet per 1000 Btu/hr (4.8 m<sup>3</sup> per kW per hour) of the aggregate input rating of all appliances installed in that space." Examples include a small room, closet, alcove, utility room, etc. A confined space must have two combustion air openings. Size the combustion air openings based on the Btu input for all gas utilization equipment in the space and the method by which combustion air is supplied.

### Using Indoor Air For Combustion

When using air from other room(s) in the building, the total volume of the room(s) must be of adequate volume (greater than 50 cubic feet per 1000 Btu/hr). Combustion air openings between joining rooms must have at least 1 square inch of free area for each 1000 Btu/hr, but not less than 100 square inches each.

### Using Outdoor Air For Combustion

Outdoor air can be provided to a confined space through two permanent openings, one commencing within 12 in. (0.30 m) of the top and one commencing within 12 in. (0.30 m) of the bottom, of the confined space. The openings shall communicate to the outside by one of two ways.

When communicating directly with the outdoors through horizontal ducts, each opening shall have a minimum free area of 1 in<sup>2</sup>/2000 Btu/hr (1100 mm<sup>2</sup>/kW) of total input rating of all appliances in the confined space.

**Note:** If ducts are used, the cross sectional area of the duct must be greater than or equal to the required free area of the openings to which they are connected.

### Louvers and Grills

When sizing the permanent opening consideration must be taken for the design of the louvers or grills to maintain the required free area required for all gas utilizing equipment in the space. If the free area of the louver or grill design is not available, assume wood louvers will have 25% free area and metal louvers or grills will have 75% free area. Under no circumstance should the louver, grill or screen have openings smaller than 1/4 in.

Examples: Wood: 10 in. x 12 in. x 0.25 = 30 in.<sup>2</sup>

Metal: 10 in. x 12 in. x 0.75 = 90 in.<sup>2</sup>

### Location

To maintain proper circulation of combustion air two permanent openings (one upper, one lower) must be positioned in confined spaces. The upper shall be within 12 in. (0.30 m) of the top of the confined space and the lower opening shall be within 12 in. (0.30 m) of the bottom of the confined space. Openings must be positioned as to never be obstructed.

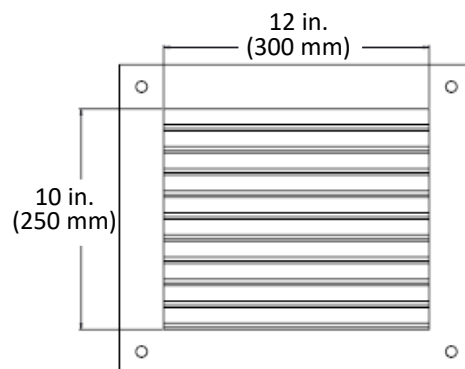

### IMPORTANT

Combustion air provided to the appliance should not be taken from any area of the structure that may produce a negative pressure (i.e. exhaust fans, powered ventilation fans).



### WARNING

To prevent possible personal injury or death due to asphyxiation, common venting with other manufacturer's induced draft appliances is not allowed.

## Checklist for Combustion Air and Venting Requirements

<input type="checkbox"/>	Verify all combustion air opening sizes are correct.
<input type="checkbox"/>	Ensure that the Combustion Air Requirements are followed that will provide sufficient combustion air for the appliance.
<input type="checkbox"/>	DO NOT use room air for combustion in applications where the indoor air is corrosive.
<input type="checkbox"/>	Verify that adequate combustion air is available for all appliances installed in the space.
<input type="checkbox"/>	Installation complies with National Fuel Gas Code, ANSI Z223.1/NFPA 54 as well as local and state regulations therein.

# Room Air: Example Vent Applications

**CAUTION** Rinnai cautions against installing the boiler in applications with venting in different pressure planes. It is possible to have poor performance with this installation.

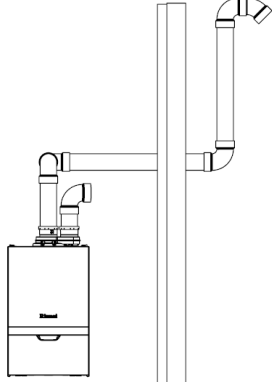
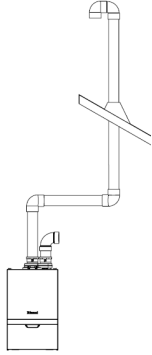
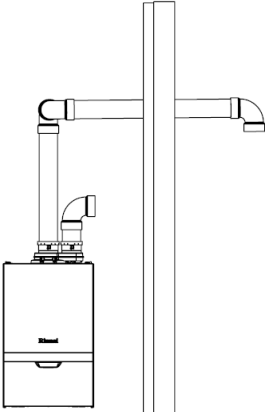
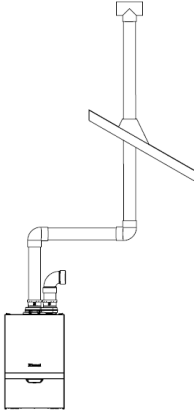
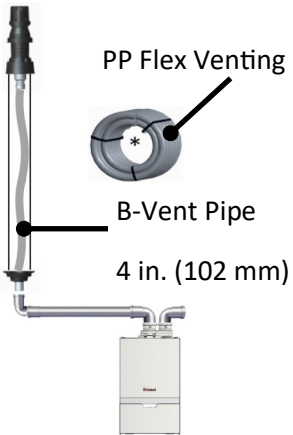
<p>2 in. or 3 in. Schedule 40 PVC/CPVC Snorkel Termination Configuration</p> 	<p>2 in. or 3 in. Schedule 40 PVC/CPVC Standard Upside Down "U" Vertical Termination Configuration</p> 
<p>2 in. or 3 in. Schedule 40 PVC/CPVC Elbow or Tee Side Wall Termination Configuration</p> 	<p>2 in. or 3 in. Schedule 40 PVC/CPVC Tee Vertical Termination Configuration</p> 
<p>Ubbink flexible venting approved for vertical non-direct vent (room air) applications only. Refer to the flex vent manual for further details.</p> <p>Termination PN: 184470NPP Flex Roll: 222721NPP</p> 	

# 6 Gas Supply

## Topics in this section

- Connect the Gas Supply
- Gas Operating Instructions
- Gas Pipe Sizing Reference Tables

## 6.1 Connect the Gas Supply

### WARNING

- A licensed professional must install the gas supply.
- Turn off 120V power supply.
- Turn off the gas.
- Gas is flammable. Do not smoke or provide other ignition sources while working with gas.
- Do not turn on the boiler or gas until all fumes are gone.

### IMPORTANT

- The boiler shall be installed such that the gas ignition system components are protected from water (dripping, spraying, rain, etc.) during appliance operation and service (circulator replacement, condensate trap, control replacement, etc.).
- A sediment trap must be provided upstream of the gas controls.
- A manual gas shutoff valve between the gas supply and the boiler must be installed.

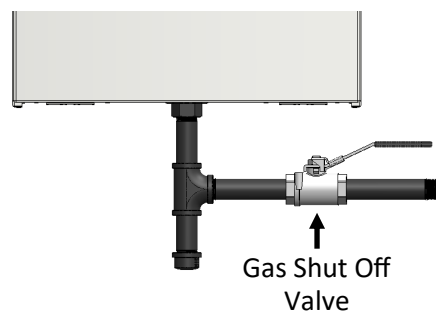

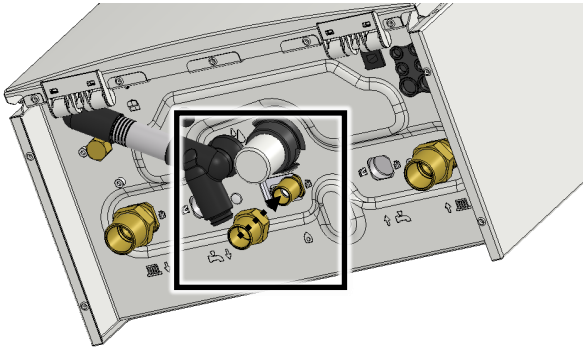

### Gas Fitting Connection

1. If the system requires a 3/4 in. connection, attach the 1/2 in. FNPT x 3/4 in. MNPT connection fitting to the gas fitting on the bottom of the boiler.
2. Check the type of gas and gas supply pressure before connecting the boiler. If the boiler is not of the gas type that the building is supplied with, converting the gas type of the boiler is necessary. A gas conversion kit is included with the boiler. Refer to section "14.5 Gas Conversion" in the Appendix for gas conversion instructions.
3. Check gas supply pressure at the inlet test port on the gas valve (see figure). Supplied gas pressure must be within the limits shown in section "3.4 Specifications" with all gas appliances operating.

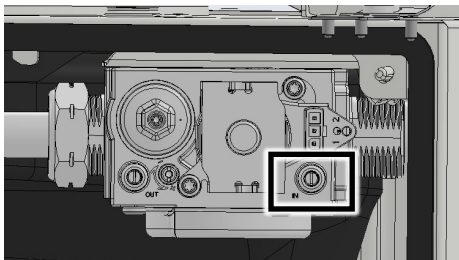

4. Before placing the appliance in operation, all joints including the connection to the boiler must be checked for gas tightness by means of soap, gas leak detector solution, or an equivalent nonflammable solution, as applicable. Since some leak test solutions, including soap and water, may cause corrosion or stress cracking, the piping shall be rinsed with water after testing, unless it has been determined that the leak test solution is non-corrosive.

5. Use approved and appropriately sized connectors to connect the boiler to the gas line. Purge the gas line of any debris before connection to the boiler.
6. Any compound used on the threaded joint of the gas piping shall be a type that resists the action of liquefied petroleum gas (propane/LPG).
7. The gas supply line shall be gas tight, sized, and so installed as to provide a supply of gas sufficient to meet the maximum demand of the heater and all other gas consuming appliances at the location without loss of pressure. If in doubt about the size of the gas line, refer to section "6.3 Gas Pipe Sizing Reference Tables."
8. Perform a leak and pressure test prior to operating the boiler. If a leak is detected, do not operate the boiler until the leak is repaired.

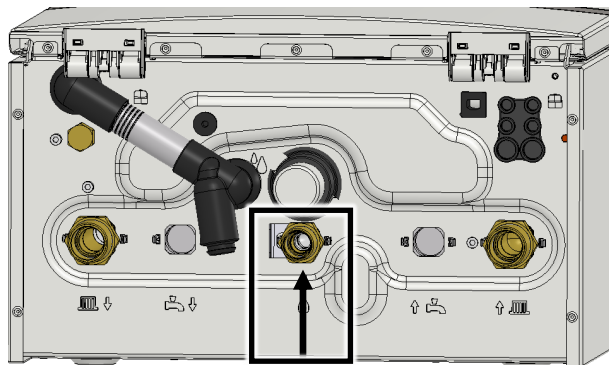

Gas connection 3/4 in. MNPT connection



## 6.2 Gas Operating Instructions

### FOR YOUR SAFETY READ BEFORE OPERATING



**WARNING:** If you do not follow these instructions EXACTLY, a fire or explosion may result causing property damage, personal injury or loss of life.

- A. This appliance does not have a pilot. It is equipped with an ignition device which automatically lights the burner. Do not try to light the burner by hand.
- B. BEFORE OPERATING smell all around the appliance area for gas. Be sure to smell next to the floor because some gas is heavier than air and will settle on the floor.

#### WHAT TO DO IF YOU SMELL GAS:

- DO NOT try to light any appliance.
  - DO NOT touch any electric switch; DO NOT use any phone in your building.
  - Immediately call your gas supplier from a neighbor's phone. Follow the gas supplier's instructions.
  - If you cannot reach your gas supplier, call the fire department.
- C. Use only your hand to turn the gas control valve. Never use tools. If the gas control valve will not turn by hand, don't try to repair it, call a qualified service technician. Force or attempted repair may result in a fire or explosion.
  - D. Do not use this appliance if any part has been under water. Immediately call a qualified service technician to inspect the appliance and to replace any part of the control system and any gas control which has been under water.

### OPERATING INSTRUCTIONS

1. STOP! Read the safety information above on this label.
2. Set the temperature controller to lowest setting.
3. Turn off all electric power to the appliance.
4. This appliance does not have a pilot. It is equipped with a direct ignition device which automatically lights the burner. DO NOT try to light the burner by hand.
5. Turn the manual gas control valve located at gas inlet of appliance clockwise  to the OFF position.
6. Wait five (5) minutes to clear out any gas. Then smell for gas, including near the floor. If you smell gas, STOP! Follow "B" in the safety information above on this label. If you don't smell gas, go to the next step.
7. Turn the manual gas control valve located at gas inlet of appliance counterclockwise  to the ON position.
8. Turn on all electric power to the appliance.
9. Set the temperature controller to desired setting.
10. If the appliance will not operate, follow the instructions "To Turn Off Gas To Appliance" and call your service technician or gas supplier.

### TO TURN OFF GAS TO APPLIANCE

1. Set the temperature controller to the lowest setting.
2. Turn off all electric power to the appliance if service is to be performed.
3. Turn the manual gas control valve located at gas inlet of appliance clockwise  to the OFF position.

## 6.3 Gas Pipe Sizing Reference Tables

The gas supply must be capable of handling the entire gas load required at the location. Gas line sizing is based on gas type, the pressure drop in the system, the gas pressure supplied, and gas line type. For gas pipe sizing, refer to the National Fuel Gas Code, ANSI Z223.1/NFPA 54, or the Natural Gas and Propane Installation Code, CSA B149.1

For some tables, you will need to determine the cubic feet per hour of gas required by dividing the gas input by the heating value of the gas (available from the local gas company). The gas input needs to include all gas products at the location and the maximum Btu usage at full load when all gas products are in use.

Use the table for your gas type and pipe type to find the pipe size required. The pipe size must be able to provide the required cubic feet per hour of gas or the required Btu/hr.

The information below is provided as an example. The appropriate table from the applicable code must be used.

### Natural Gas

Pressure Drop 0.5 in. w.c.				
Information in table obtained from NFPA 54, ANSI Z223.1 - 2015.	Schedule 40 Metallic Pipe			
	Inlet Pressure:		Less than 2 psi	
	Specific Gravity:		0.60	
	Nominal Pipe Size (in.)			
	1/2	3/4	1	1 1/4
Length in ft (meters)	Capacity in Cubic Feet of Gas per Hour			
10 (3)	172	360	678	1,390
20 (6)	118	247	466	957
30 (9)	95	199	374	768
40 (12)	81	170	320	657
50 (15)	72	151	284	583
60 (18)	65	137	257	528
70 (21)	60	126	237	486
80 (24)	56	117	220	452
90 (27)	52	110	207	424
100 (30)	50	104	195	400

### GAS PIPE SIZING CALCULATION WORKSHEET

Instructions: Enter values in empty boxes.

Rinnai Model Gas Input:

A  Btu/hr

Additional Appliance Total Gas Input:

B  Btu/hr

Heating Value of Gas:

C  Btu/ft<sup>3</sup>

Cubic Feet Per Hour (CFH):

$$(CFH) = \frac{A + B}{C}$$

$$(CFH) = \frac{\text{[ ]}}{\text{[ ]}}$$

ANSWER: CFH =  FT<sup>3</sup>/HR

### EXAMPLE

Rinnai Model Gas Input:

A  BTU/HR

Additional Appliance Total Gas Input:

B  BTU/HR

Heating Value of Gas:

C  BTU/FT<sup>3</sup>

Cubic Feet Per Hour (CFH):

$$(CFH) = \frac{A + B}{C}$$

$$(CFH) = \frac{160,000 + 65,000}{1000}$$

ANSWER:

CFH =  FT<sup>3</sup>/HR

For this example, the pipe diameter must be at least 3/4 in. pipe size and 10 ft (3 m) in length.

## Natural Gas

Pressure Drop 3.0 in. w.c.				
Intended use: Initial supply pressure of 8.0 in. w.c. or greater.	Schedule 40 Metallic Pipe			
	Inlet Pressure:	Less than 2 psi		
	Specific Gravity:	0.6		
Information in table obtained from NFPA 54, ANSI Z223.1 - 2015.	Nominal Pipe Size (in.)			
		1/2	3/4	1
Length in ft (meters)	Capacity in Cubic Feet of Gas per Hr			
10 (3)	454	949	1,790	3,670
20 (6)	312	652	1,230	2,520
30 (9)	250	524	986	2,030
40 (12)	214	448	844	1,730
50 (15)	190	397	748	1,540
60 (18)	172	360	678	1,390
70 (21)	158	331	624	1,280
80 (24)	147	308	580	1,190
90 (27)	138	289	544	1,120
100 (30)	131	273	514	1,060

**EXAMPLE**

Rinnai Model Gas Input:

A  BTU/HR

Additional Appliance total Gas Input:

B  BTU/HR

Heating Value of Gas:

C  BTU/FT<sup>3</sup>

Cubic Feet Per Hour (CFH):

$$(CFH) = \frac{A + B}{C}$$

$$(CFH) = \frac{160,000 + 65,000}{1000}$$

**ANSWER:**

CFH =  FT<sup>3</sup>/HR

For this example, the pipe diameter must be at least 1/2 in. nominal pipe size and 20 ft (6 m) in length.

## Propane (Undiluted)

Pressure Drop 0.5 in. w.c.				
Information in table obtained from NFPA 54, ANSI Z223.1 - 2015.	Schedule 40 Metallic Pipe			
	Inlet Pressure:	11 in. w.c.		
	Specific Gravity:	1.50		
	Nominal Inside Pipe Size (in.)			
		1/2	3/4	1
Length in ft (meters)	Capacity in Thousands of Btu/hr			
10 (3)	291	608	1,150	2,350
20 (6)	200	418	787	1,620
30 (9)	160	336	632	1,300
40 (12)	137	287	541	1,110
50 (15)	122	255	480	985
60 (18)	110	231	434	892
80 (24)	101	212	400	821
100 (30)	94	197	372	763

**EXAMPLE**

Rinnai Model Gas Input:

A  BTU/HR

Additional Appliance Total Gas Input:

B  BTU/HR

Total Gas Input:

$$\text{Total Gas Input} = A + B$$

$$\text{Total Gas Input} = 160,000 + 65,000$$

**ANSWER:**

Total Gas Input =  BTU/HR

For this example, the pipe diameter must be at least 1/2 in. nominal pipe size and 10 ft (3 m) in length.

# 7

# CH System Piping

## Topics in this section

- Guidelines
- Instructions
- Common CH Components
- Piping Diagram for a Basic CH System
- Hydraulic Separation
- Connect the Pressure Relief Valves (DHW and CH)
- Connect the Condensate Drain Line

## 7.1 Guidelines

- Purge the heating system to remove all debris and air. Debris and air in the lines will damage the boiler.
- When removing the plastic sealing caps from the boiler connections, water may come out of the boiler due to live fire testing during manufacturing.
- The boiler, when used in connection with a refrigeration system, must be installed so the chilled medium is piped in parallel with the boiler with appropriate valves to prevent the chilled medium from entering the boiler.
- The boiler piping system of a hot water boiler connected to heating coils located in air handling units where they may be exposed to refrigerated air circulation must be equipped with flow control valves or other automatic means to prevent gravity circulation of the boiler water during the cooling cycle.
- Some installations with multiple zone valves may require a differential bypass, which will prevent excessively high flow rates through a single zone when the other zone valves are closed.

- It is required to include an air separator on the central heating supply of the system.
- System piping should be insulated when freezing is a potential concern.
- All piping must comply with local, state, national or ASME code as appropriate.

### CAUTION

The boiler may not be installed directly to a heating system where polybutylene or other oxygen permeable piping is used.

## 7.2 Instructions

To connect the water supply, follow the instructions below.

For standard installations, refer to the “Piping Diagram for Basic Central Heating Installation” in this chapter.

### IMPORTANT

Water connections to the boiler should follow all state and local plumbing codes.

1. Attach the 3/4 in. FNPT x 1 in. MNPT connection fitting to the supply and return heating fittings on the bottom of



Supply and Return Fitting Connections

2. Plumb the heating supply and return lines to the heating supply connection on the bottom of the boiler. It is required to use primary/secondary piping to the heating system.

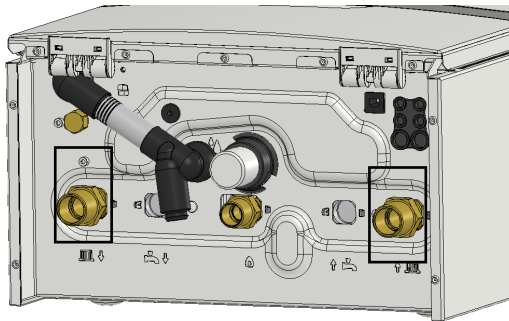

Heating Supply and Return Connection

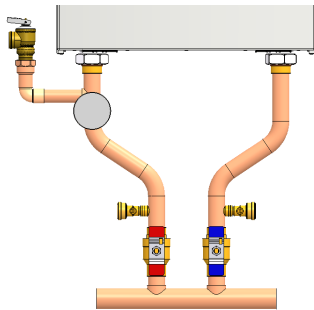

Boiler with Primary Secondary Heating Kit

## 7.3 Common CH Components

Listed below are common components in a Central Heating system. Refer to the diagram on the next page.

- **Expansion Tank** — A properly sized expansion tank charged to 2 PSI (14 kPa) below the cold system pressure is required to limit pressure changes in the heating system. When replacing an expansion tank, consult the expansion tank manufacturer for sizing.
- **Air Separator** — An air separator is needed on the central heating supply side of the system to remove any air that may be present in the piping.
- **Water Fill Valve** — Maintains proper water pressure in the central heating circuit.
- **Pressure/Temperature Gauge** — The current pressure and temperature will alternately be displayed on the boiler control panel. A port for an external gauge is present in the Primary-Secondary Heating Kit accessory offered by Rinnai.
- **Pressure Relief Valve (PRV)** — A PRV located directly on the supply side of the boiler is required. The PRV must be 3/4 in. with at least 30 PSI (207 kPa) and a maximum of 45 PSI (310 kPa). A 30 PSI (207 kPa) PRV is supplied with the boiler. A port for the central heating PRV is present in the Primary-Secondary Heating Kit accessory offered by Rinnai.
- **Oxygen Elimination** — The boiler may only be installed in a pressurized closed-loop heating system, free of air and other impurities. If using oxygen permeable tubing in the central heating system, a plate heat exchanger is necessary to isolate the tubing and boiler.
- **Low Water Cut Off (LWCO)** — This boiler has a factory-installed pressure sensor type LWCO. The boiler's internal LWCO is not serviceable or adjustable. Check your local codes to determine if an external LWCO is required and if this device conforms to the local code. If a LWCO is required to be installed, the probe must be located higher than the minimum safe water level. When a LWCO is installed, it must be wired back to the appropriate terminal on the boiler PC Board.
- **Back Flow Preventer** — Use a back flow preventer in the filling circuit to the appliance as required by local code.
- **Dirt Trap** — Protects the boiler from debris in the plumbing system.

## CH System Common Components Diagram

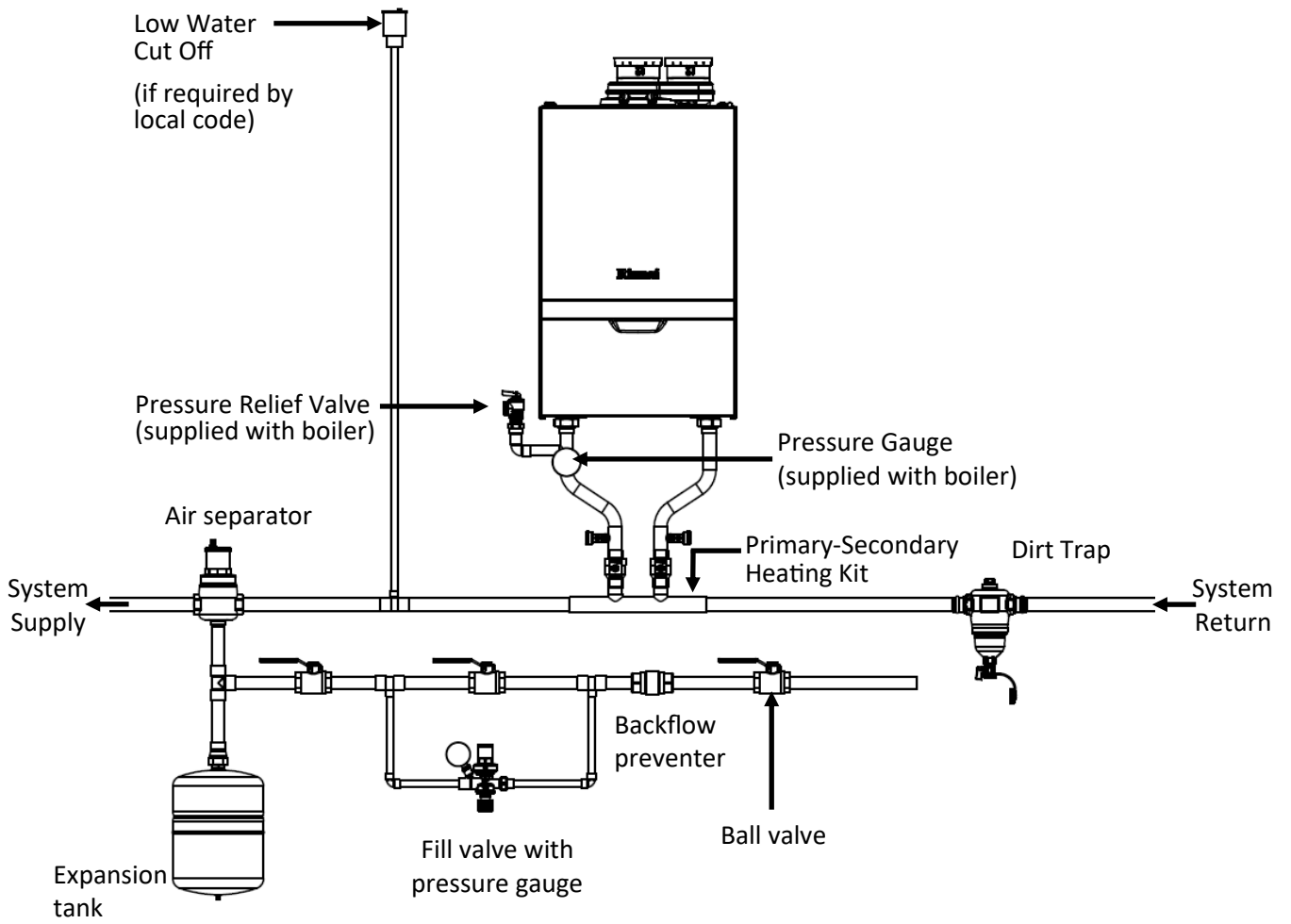

# 7.4 Piping Diagram for a Basic CH System

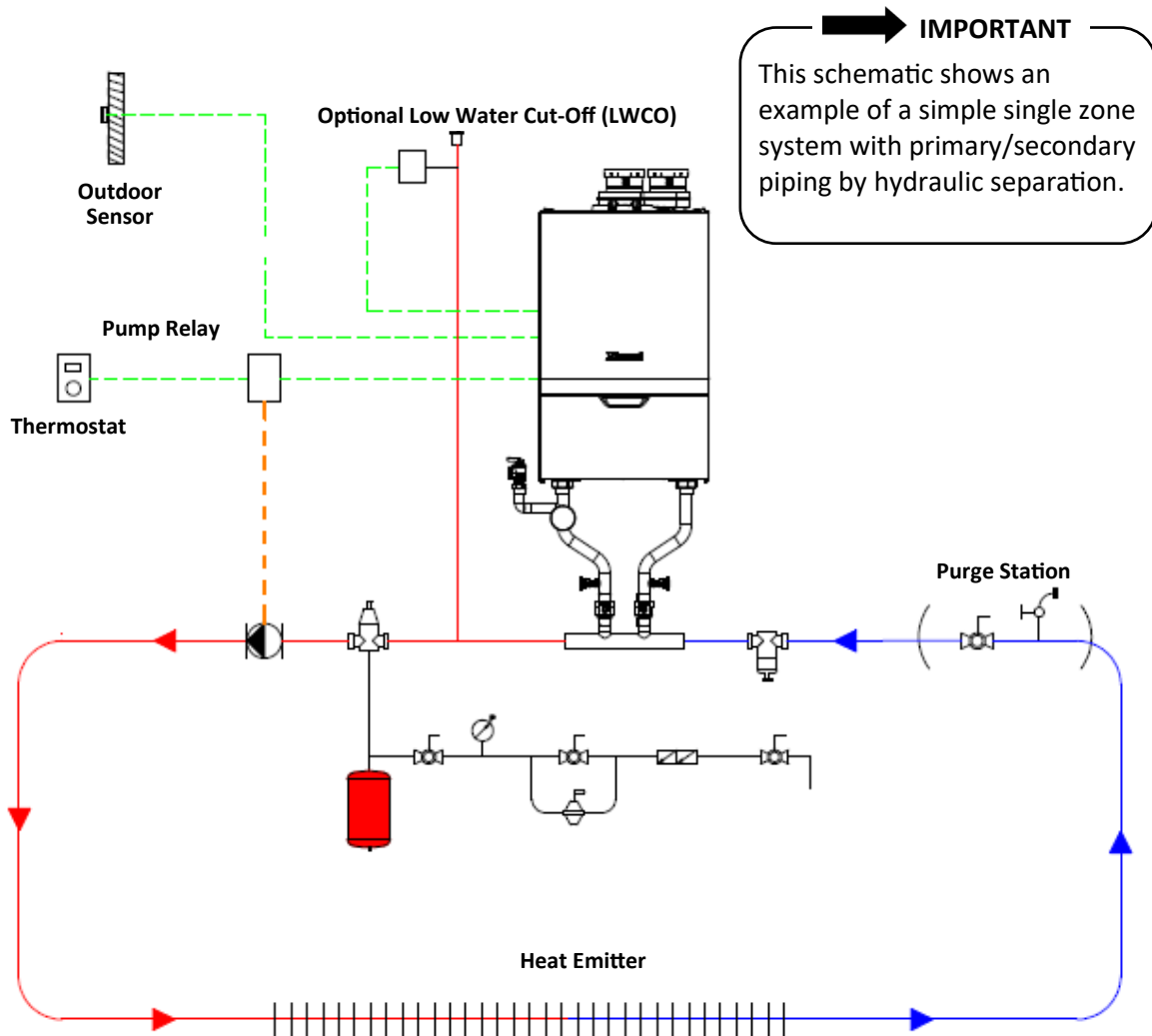

**IMPORTANT**  
 This schematic shows an example of a simple single zone system with primary/secondary piping by hydraulic separation.

This is not an engineering drawing; it is intended only as a guide and not as a replacement for professional engineering project drawings. This drawing is not intended to describe a complete system. It is up to the contractor or engineer to determine the necessary components and configuration of the particular system to be installed. The drawing does not imply compliance with local building code requirements. It is the responsibility of the contractor or engineer to ensure the installation is in accordance with all local building codes. Confer with local building officials before installation.

**LEGEND**

**Heat Emitter**

**Low Voltage Wiring**

**High Voltage Wiring**

**Air Separator** **Dirt Trap** **Pressure gauge** **Manual Fill Valve** **Back flow preventer** **Ball valve**

**Automatic Fill Valve**

*This picture illustrates a suggested arrangement. Some of the fittings are optional.*

## 7.5 Hydraulic Separation

Rinnai requires hydraulic separation between the boiler and central heating system. Hydraulic separators allow for no pump curve matching or flow calculation; this is ideal for multi-temperature and multi-zone systems.

### Examples of Hydraulic Separation

Closely spaced tees and low loss headers are common examples of hydraulic separators and can be used to separate the boiler loop from the central heating loop.

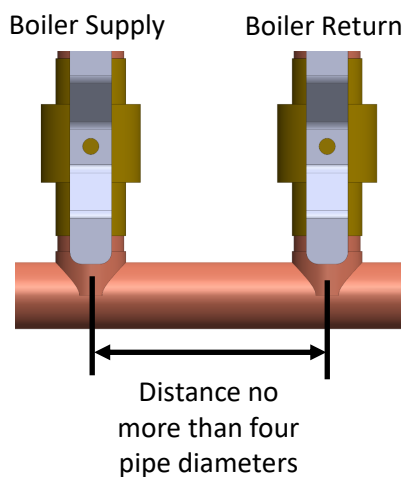
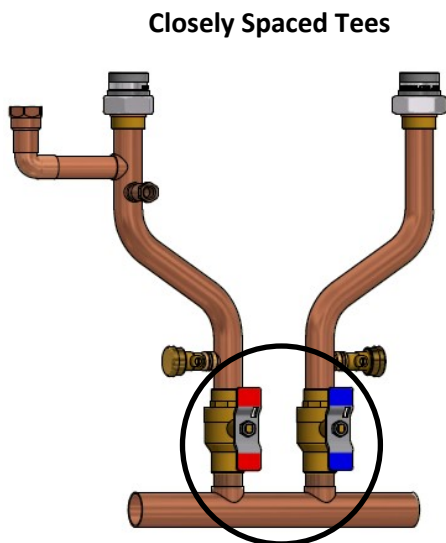

**IMPORTANT**

For closely spaced tee installations, the separation at the header is to be no more than four pipe diameters.

**Low Loss Header**

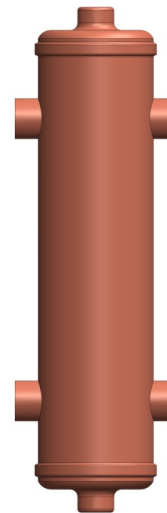



## 7.6 Connect the Pressure Relief Valves (DHW and CH)

### **WARNING**

Water discharged from the pressure relief valve could cause severe burns instantly or death from scalds.

### 7.7.1 General Guidelines

An approved pressure relief valve is required by the *American National Standard (ANSI Z21.13)* and *ASME Boiler and Pressure Vessel Code, Section IV (Heating Boilers)* for all water heating systems and shall be accessible for servicing (an approved pressure relief valve is supplied with the boiler). When connecting a pressure relief valve, follow the guidelines below:

- The pressure relief valve must comply with the standard for *Relief Valves and Automatic Gas Shutoff Devices for Hot Water Supply Systems ANSI Z21.22*, the standard *Temperature, Pressure, Temperature and Pressure Relief Valves and Vacuum Relief Valves, CAN1-4.4*, and/or the *ANSI/ASME Boiler and Pressure Vessel Code, Section IV (Heating Boilers)*.
- The pressure relief valve must be rated up to 150 psi for DHW systems, and to at least the maximum Btu/hr of the appliance.
- The pressure relief valve must be rated up to 30 psi for central heating systems, and to at least the maximum Btu/hr of the appliance.
- The discharge from the pressure relief valve should be piped to the ground or into a drain system per local codes.
- The pressure relief valve must be manually operated once a year to check for correct operation.
- The discharge line from the pressure relief valve should pitch downward and terminate 6 in. (152 mm) above drains where discharge will be clearly visible.

- The discharge end of the line shall be plain (unthreaded) and a minimum of 3/4 in. nominal pipe diameter. The discharge line material must be suitable for water at least 180° Fahrenheit.
- If a pressure relief valve discharges periodically, this may be due to thermal expansion in a closed water supply system. Contact the water supplier or local plumbing inspector on how to correct this situation. Do not plug the pressure relief valve.
- The *American National Standard (ANSI Z21.13)* does not require a combination temperature and pressure relief valve for this appliance. However, local codes may require a combination temperature and pressure relief valve.
- Protect pressure relief valve and pressure relief valve discharge line from freezing. Do not plug or restrict flow of the pressure relief valve.

### **IMPORTANT**

An ASME 30 psi safety pressure relief valve is included with the boiler and must be fitted before any shut off valve in the system.

- DO NOT plumb the pressure relief valve with the condensate drain; both must be plumbed independently to drain.
- DO NOT plug the pressure relief valve and do not install any reducing fittings or other restrictions in the relief line. The pressure relief line should allow for complete drainage of the valve and the line.
- DO NOT place any other valve or shutoff device between the pressure relief valve and the boiler.

# 7.7 Connect the Condensate Drain Line

## 7.7.1 Guidelines

- Do not plumb the condensate drain with the pressure relief valve; both must be plumbed independently to drain.
- All condensate must drain and be disposed of according to local codes.
- Use only corrosion resistant materials for the condensate drain lines such as PVC pipe or plastic hose.
- The condensate drain pipe (along its entire length) must be at least 1/2 in.
- Condensation drain lines installed in areas that are subject to freezing temperatures should be wrapped with an approved supplemental heat source. Install per manufacturer's instructions.
- Slope the condensate drain lines toward the inside floor drain or condensate pump.
- The end of the condensate drain pipe should be open to the atmosphere. The end should not be under water or other substances.

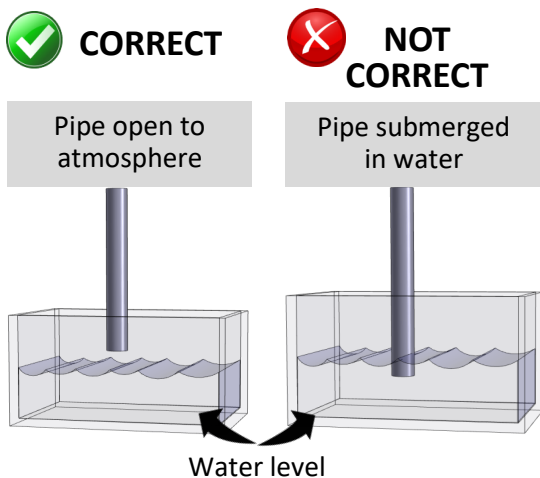

- If the condensate drain pipe is closed or stuck, the drain water will come out from the side hole on the condensate drain pipe connection.
- If a floor drain is not available or the drain is above the level of the condensate drain, a condensate pump should be installed.
- A condensate neutralizer kit is available from Rinnai. The kit allows condensate to flow through neutralizing media that raises the pH of the condensate to a level that will help prevent corrosion of the drain and public sewer system. Refer to section “3.6 Accessories” for more information.
- The condensate drain pipe should be as short as possible and have a downward pitch.
- Before operation of the boiler, the condensate collector must be filled with water.

### ✗ DO NOT

- **DO NOT connect the condensate drain line with an air conditioning evaporator coil drain.**
- **Boilers have an integrated condensate trap. DO NOT install an external condensate trap.**



**EXTERNAL TRAP NOT REQUIRED**

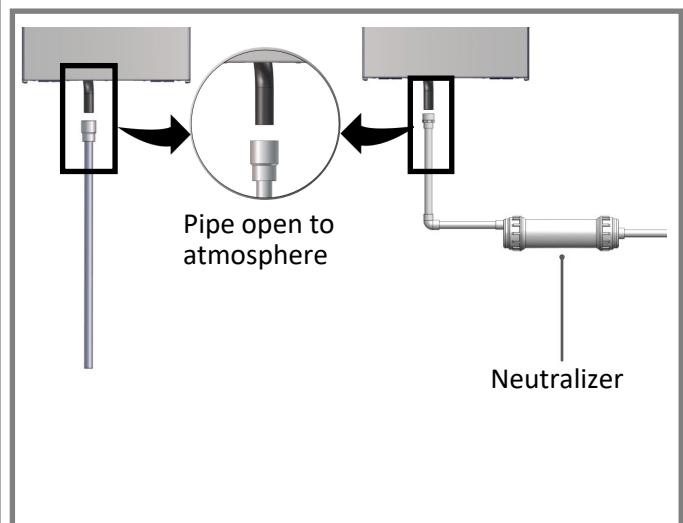

Refer to neutralizer Installation Manual and local codes for neutralizer installation guidelines. Image is for reference purposes only.

## 7.7.2 Connect the Condensate Drain Kit

### Tools/Materials Required

- Multi-purpose grease or lubricant

### Verify Contents

Item #	Item	Qty
a	Elbow with flexible pipe	1
b	T-piece, elbow and flexible pipe assembly	1
c	Flexible drain pipe	1
d	Condensate drain inner tube	1
e	Condensate drain outer tube	1
f	Condensate collector cover	1

### Instructions

Reference Figure 1 for the following instructions.

1. Press and turn the assembly (3), with the elbow first, in the corresponding holes in the bottom plate of the boiler.
2. Press the black flexible pipe (1) from inside the boiler in the rubber T-piece (3).
3. Press the black rubber elbow with flexible drain pipe (1) on the condensate tray (2).
4. Lead the long black flexible pipe (4) through the free hole of the boiler frame and press it in the T-piece (3).
5. Lead the other end of the flexible pipe outside the boiler to the drain.
6. Fill the condensate drain outer tube (5) with 150 ml (about 5 oz.) of water.
7. Apply multi-purpose grease or lubricant to the top of the o-ring on the condensate drain inner tube (6).
8. Insert the condensate drain inner tube (6) through the hole in the bottom plate of the boiler into the condensate tray (2) of the heat exchanger; you will hear a click when it is fully seated. Next, insert the condensate drain outer tube through the hole. Secure the condensate drain out tube with the securing clip (7) by turning it clockwise.
9. Press the sealing ring (8) around the outer condensate tube and press/turn it in the bottom plate of the boiler.

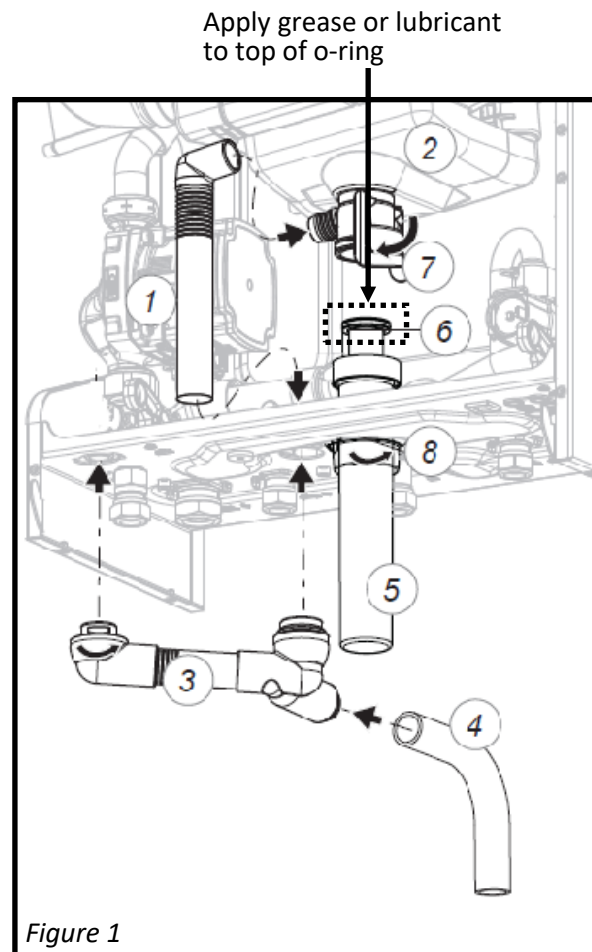
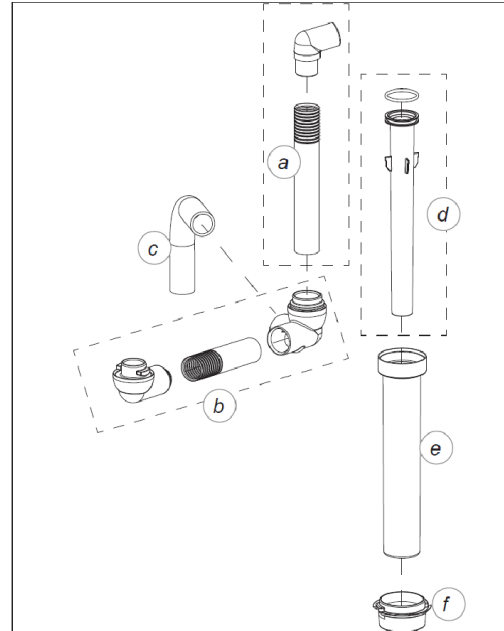

Figure 1

# 8

# DHW System Piping with Indirect Tank

## Topics in this section

- Guidelines
- Indirect Tank Control Options

This boiler provides DHW through an indirect tank. The boiler incorporates temperature control features for the boiler and indirect tank controls, including indirect tank heating priority.

## 8.1 Guidelines

- The piping (including soldering materials) and components connected to this appliance must be approved for use in potable water systems.
- Purge the water line to remove all debris and air. Debris will damage the boiler.
- DHW must not be connected to a system that was previously used with a non-potable water heating appliance.
- DO NOT introduce toxic chemicals such as those used for boiler water treatment to the potable water used for central heating into the DHW system.

## 8.2 Indirect Tank Control Options

The indirect tank temperature is controlled through either a thermistor or thermostat.

- **Thermostat (Default):** If thermostat control of the tank is desired, the thermostat connects to the yellow DHW screw terminal on the PC Board.
- **Thermistor:** If thermistor control of the tank is desired, connect a 10k NTC thermistor to the yellow DHW screw terminal on the PC Board. The thermistor will automatically be detected.

### NOTE:

Do not adjust Parameter 2.5.0. This should always be set for "ON" when used with an indirect tank.

### **DANGER**



Water temperatures over 125°F (52°C) can cause severe burns or scalding resulting in death.

Hot water can cause first degree burns with exposure for as little as:

- 3 seconds at 140°F (60°C)
- 20 seconds at 130°F (54°C)
- 8 minutes at 120°F (49°C)

Children, disabled, or elderly are at highest risk of being scalded. Feel water before bathing or showering.

# 9

# Power Supply

## Topics in this section

- Guidelines
- Electrical Connections
- Post-Power Supply Connection Checklist

## WARNING

- Do not use an extension cord or adapter plug with the boiler.
- If an external electrical source is utilized, the boiler, when installed, must be electrically bonded to ground in accordance with the requirements of the authority having jurisdiction or, in the absence of such requirements, with the National Electrical Code, ANSI/NFPA 70, and/or the Canadian Electrical Code Part I, CSA C22.1, Electrical Code.

## CAUTION

- This boiler is supplied with 120 volts and is equipped with a three-prong (grounding) plug for your protection against shock hazard. The plug should be plugged directly into a properly grounded three-prong receptacle. Do not cut or remove the grounding terminal from this plug.
- Disconnect incoming power to the boiler by removing the three-prong plug before:
  - Performing repairs or installation to internal components or accessories.
  - Making wiring connections and/or changes to the wiring terminals on the boiler.

## CAUTION

- No changes may be made to the wiring of the boiler.
- All connections should be designed in accordance with the applicable regulations.
- Label all wires prior to disconnection when servicing controls. Wiring errors can cause improper and dangerous operation.
- Verify proper operation after operation servicing.

## 9.1 Guidelines

When connecting the power supply, follow these guidelines:

- If using the 6.5 ft (2 m) power cord (supplied with boiler), plug it into a standard three-prong 120 VAC, 60 Hz properly grounded wall outlet.
- The boiler requires 120 VAC, 60 Hz power from a properly grounded circuit.
- Do not rely on the gas or water piping to ground the boiler. Ground locations are provided inside the boiler.
- The wiring diagram is located on the inside of the boiler front cover.

## IMPORTANT

A manually operated remote switch should be located outside the boiler room door for shutting down the boiler. Consideration should be given to protect the switch against tampering. If there is more than one door to the boiler room, a switch should be located at each door.

## 9.2 Electrical Connections

Devices such as the room thermostat and outdoor temperature sensor are connected to the connection terminal. The connection terminals are located on the top and back of the controller.

To access the controller, remove the front panel (see section “3.7 How to Remove the Front Panel” for detailed instructions).

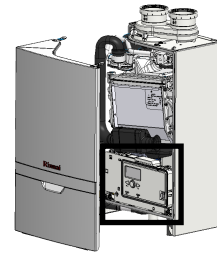

Controller

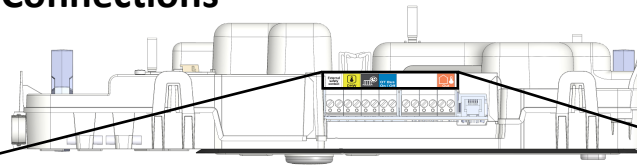

External safety contact	<b>DHW</b>	<b>DO NOT USE</b> For Rinnai Use Only	<b>OT Bus On / Off</b>	<b>DO NOT USE</b> For Rinnai Use Only	<b>DO NOT USE</b> For Rinnai Use Only	<b>Out</b>
External safety contact (remove jumper to use)	DHW Indirect Tank Temp Sensor	<b>DO NOT USE</b> For Rinnai Use Only	Room thermostat (On/Off thermostat or control)	<b>DO NOT USE</b> For Rinnai Use Only	<b>DO NOT USE</b> For Rinnai Use Only	Outdoor temperature sensor

### Controller Back Connections

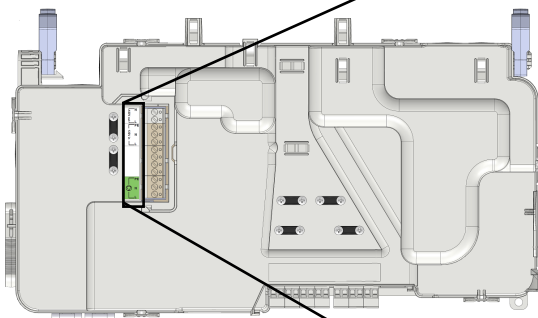

<b>DO NOT USE</b> This terminal is for Rinnai-use only and not for use in any installation
<b>120 V Supplied power cord to boiler</b>
<b>DO NOT USE</b> This terminal is for Rinnai-use only and not for use in any installation
<b>System Pump Relay</b> Energized on a call for DHW.

## 9.3 Post-Power Supply Connection Checklist

<input type="checkbox"/>	Confirm that the electricity is supplied from a 120 VAC, 60 Hz power source and is in a properly grounded circuit.
<input type="checkbox"/>	Confirm that an extension cord or adapter plug has NOT been used with the boiler.
<input type="checkbox"/>	Confirm connection terminals are connected correctly.

# 10 Commissioning

## Topics in this section

- Safety Precautions
- Instructions
- Air Purge Process

### THIS SECTION IS INTENDED FOR THE INSTALLER

This boiler must be commissioned by a licensed professional. Installer qualifications: A trained and qualified professional must install the appliance, inspect it, and leak test the boiler before use. The warranty will be voided due to any improper installation. The trained and qualified professional should have skills such as: Gas sizing; Connecting gas lines, water lines, valves, and electricity; Knowledge of applicable national, state, and local codes; Installing venting through a wall or roof; and training in installation of condensing boilers. Training for Rinnai Condensing Boilers is accessible online at [www.trainingevents.rinnai.us](http://www.trainingevents.rinnai.us).

Boiler commissioning is a procedure used after boiler installation to ensure the system and boiler were installed correctly and ready for operation.

## 10.1 Safety Precautions

### WARNING

Failure to properly commission the boiler as described in this section may result in unreliable and unsafe burner operation and reduced component life.

### IMPORTANT

- Work on the boiler must be carried out by a licensed professional, using correctly calibrated instruments with current test certification. The commissioning instructions are intended for licensed professionals who have the necessary knowledge and are approved for working on heating and gas systems.
- The boiler and its individual shut off valve must be disconnected from the gas supply piping system during any pressure testing of that system at test pressures in excess of 1/2 PSI (3.5 kPa).
- Before the boiler is fired for the first time:
  - Ensure the boiler and system are fully de-aerated
  - Purge the gas line between the gas meter and boiler
  - Prime the pump (as described in this section)

## 10.2 Instructions

### You Will Need:

- Philips head screwdriver
- Flat head screwdriver
- Combustion analyzer (calibrated)

### Step 1: Prime the Pump

1. Remove the boiler front cover. See section “3.7 How to Remove the Front Panel” for complete instructions.
2. Locate the vent pump.

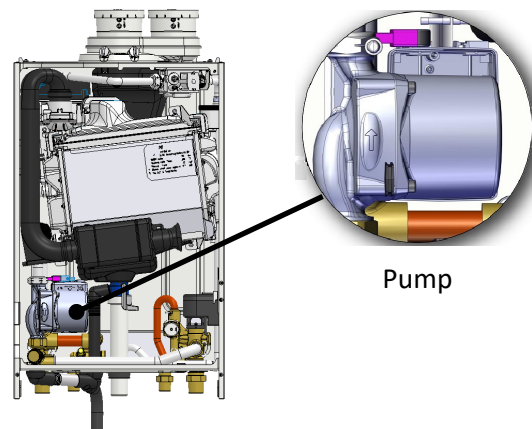



- Remove the vent pump screw.

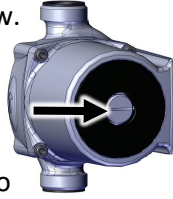

- Use a flat head screwdriver to ensure the impeller spins freely.

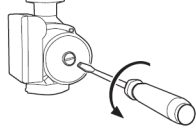

- When the impeller spins freely and water exits through the vent port, the pump is ready for operation.
- Replace the vent pump screw.
- Proceed to the next step.

## Step 2: Set the O2 at Maximum Input

### THIS SECTION IS INTENDED FOR THE INSTALLER

#### NOTICE

- The O2 percentage setting is required to be checked at commissioning, maintenance and faults and adjusted if needed.
- Correct gas supply pressure must be confirmed before testing O2.
- The boiler front cover must be in place for accurate flue gas testing.

#### WARNING

The O2 percentage is required to be checked and adjusted after a conversion from Natural Gas to Liquid Propane, or from Liquid Propane to Natural Gas. Setting the O2 at maximum input must be performed with a calibrated combustion analyzer that is set to the correct gas type.

- Put the boiler into operation with a maximum DHW or heat demand.
- From the controller home screen, press and hold the **Chimney Active** button for approximately 7 seconds.
- Remove the plug covering the **flue gas** test port and place the calibrated combustion analyzer probe into the port (see right image).

- Scroll to **ON** and press **OK**.
- Scroll to **100%** and press **OK**.
- The boiler is now at maximum input.
- After the boiler has run for approximately one minute, the O2 percentages displayed on the combustion analyzer should match the ranges shown in the table below.

If the ranges do not match, adjust the parameters by following the steps in the **Adjust O2 Percentages** section.

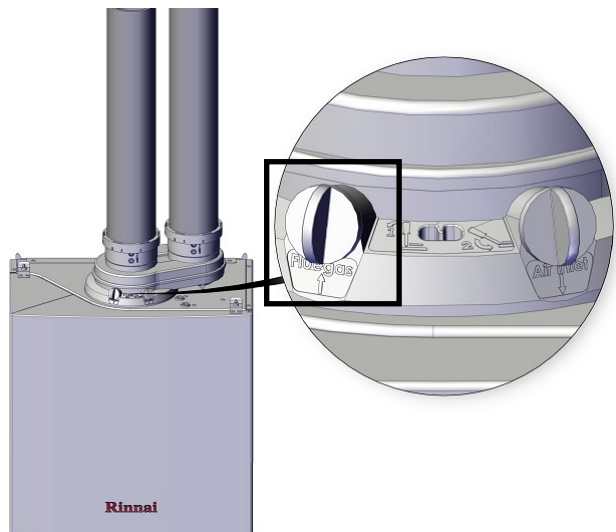

Table: Nominal O2 Percentages

Model	MAXIMUM INPUT		MINIMUM INPUT	
	Natural Gas	Liquid Propane	Natural Gas	Liquid Propane
M060S	4.7 - 4.9	5.0 - 5.2	0.4-1.6% Higher Than Observed on Max. Input	4.7-5.5
M090S	4.7 - 4.9	5.0 - 5.2		
M120S	4.2 - 4.4	5.0 - 5.2		
M160S	4.2 - 4.4	5.0 - 5.2		



## Step 3: Set the O2 at Minimum Input

### THIS SECTION IS INTENDED FOR THE INSTALLER

1. While still in service mode (as described in the previous step), use the scroll wheel to adjust to **0%**.
2. Press **OK**.
3. The boiler is now at minimum input.
4. After the boiler has run for approximately one minute, the O2 value displayed on the combustion analyzer should read a value as shown in the chart on **Nominal O2 Percentages** table (see section **Step 2: Set the O2 at Maximum Input**).

Example: If maximum input value is 4.8% on natural gas, then minimum input value should be between 5.2% and 6.4%.

If the values do not match, adjust the parameters by following the steps in the **Adjust O2 Percentages** section.

5. When adjustments are complete, place the plug back into the flue gas test port.
6. On the controller, press and hold the **Back** button until the Home screen appears in the window.

## Adjust O2 Percentages

This section is required only if it is necessary to adjust O2 percentages.

Rotate the screw on the gas valve assembly slowly. Allow the boiler to operate for approximately one minute for the O2 value to stabilize. Repeat until you reach the levels shown in the **Nominal O2 Percentages** table (see section **Step 2: Set the O2 at Maximum Input**).

- Rotate counter-clockwise to decrease the O2 percentage
- Rotate clockwise to increase the O2 percentage

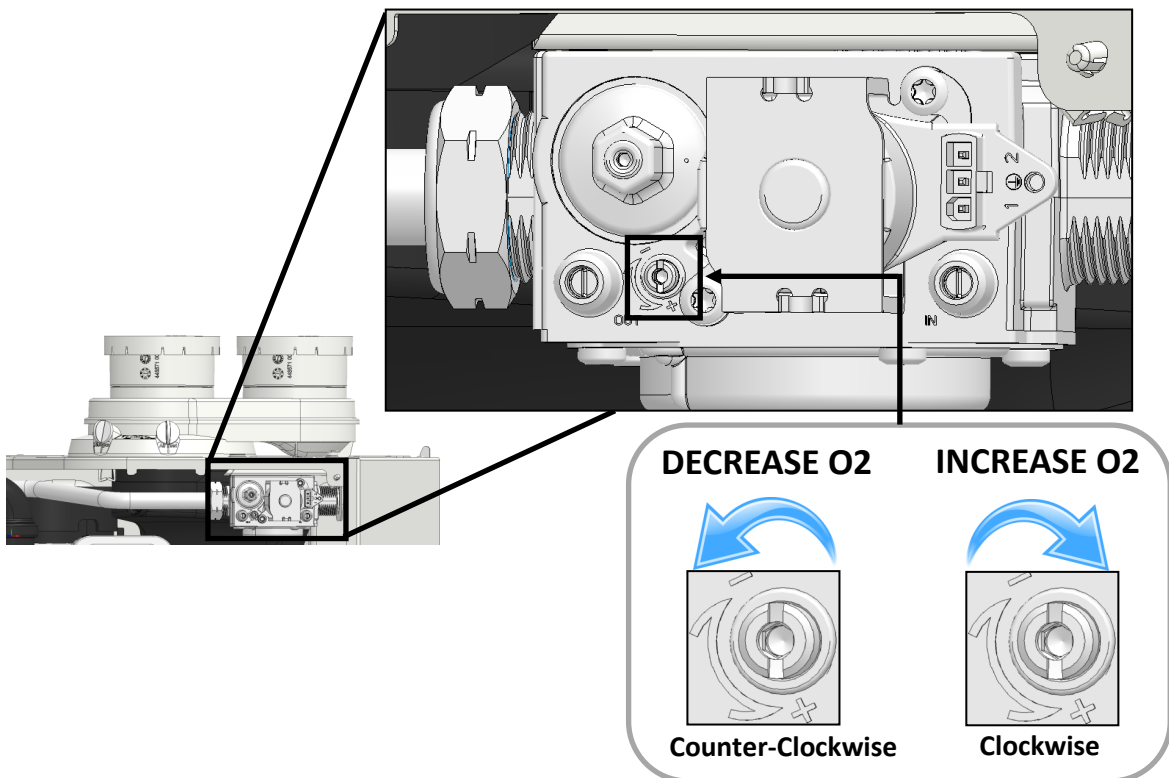

## 10.3 Air Purge Process

The boiler comes equipped with an automatic air purging process. This is a seven minute process designed to eliminate air in the water. The air purge program will start whenever the water pressure in the boiler gets below 10 PSI or when the boiler is powered on. The boiler will eliminate air from the water through the air vent on the heat exchanger. A minimum of 19 PSI is needed to complete the air purge process.

### 10.3.1 Bypass Air Purge Process

---

The boiler's internal air purge process is an effective method of purging air from the boiler after the system has been filled or serviced.

Do not bypass the air purge process during commissioning or if the system pressure has dropped below 10 PSI. If there is any chance that air has entered the system, air purging is critical to prevent damage to the boiler.

#### **WARNING**

**DO NOT** bypass the air purge program during commissioning or if any part of the system has been opened or disconnected. Failure to properly purge air from the boiler and system may result in damage to the boiler, which is not covered by the boiler warranty.

To bypass the air purge process, press and hold the **BACK** button for approximately seven seconds. This will put the boiler back into normal operation mode.

# 11

# Post-Installation Checklist

Complete the following checklist when boiler installation is complete. You should be able to answer YES to each question. If you answer NO, installation is not complete. Refer to the applicable section in this manual for additional information.

<b>INSTALLATION LOCATION</b>	<b>YES</b>	<b>NO</b>
Have you verified the unit, vent and air intakes meet the clearance requirements?	<input type="checkbox"/>	<input type="checkbox"/>
<b>VENTING</b>	<b>YES</b>	<b>NO</b>
Have all corrosive compounds been removed from around the combustion air intake of the boiler?	<input type="checkbox"/>	<input type="checkbox"/>
Have you followed the combustion air requirements to provide sufficient combustion air for the boiler?	<input type="checkbox"/>	<input type="checkbox"/>
Are the correct venting products for the installed model being utilized?	<input type="checkbox"/>	<input type="checkbox"/>
Have you installed the vent screen(s) for Schedule 40 PVC/CPVC vent applications if applicable?	<input type="checkbox"/>	<input type="checkbox"/>
Have you verified the vent system does not exceed maximum length?	<input type="checkbox"/>	<input type="checkbox"/>
<b>SYSTEM PIPING</b>	<b>YES</b>	<b>NO</b>
Have the water lines been purged of all debris and the filter cleaned?	<input type="checkbox"/>	<input type="checkbox"/>
Have you verified the hot and cold water lines to the boiler are not interchanged?	<input type="checkbox"/>	<input type="checkbox"/>
Does the water supply to the boiler have adequate pressure? Is it free of chemicals? Did you verify it does not exceed total hardness that will damage the heat exchanger?	<input type="checkbox"/>	<input type="checkbox"/>
Have you verified that no toxic chemicals were introduced to the potable water?	<input type="checkbox"/>	<input type="checkbox"/>
Did you drain the boiler if not intended to be used immediately?	<input type="checkbox"/>	<input type="checkbox"/>
Have water quality issues (if any) been addressed?	<input type="checkbox"/>	<input type="checkbox"/>
Have you performed the leak and pressure test for the boiler and plumbing system?	<input type="checkbox"/>	<input type="checkbox"/>
Are the isolation valves installed? (for DHW systems only)	<input type="checkbox"/>	<input type="checkbox"/>
<b>CONDENSATE DRAIN</b>	<b>YES</b>	<b>NO</b>
If the condensate pump is installed, is it wired to deactivate the boiler in the event of failure?	<input type="checkbox"/>	<input type="checkbox"/>
Did you verify the condensate drain pipe is as short as possible and has a downward pitch toward the drain or condensate pump?	<input type="checkbox"/>	<input type="checkbox"/>
Is all condensate drained and disposed of as per local codes?	<input type="checkbox"/>	<input type="checkbox"/>
Did you use ONLY corrosion resistant materials for the condensate drain lines?	<input type="checkbox"/>	<input type="checkbox"/>
Did you verify the condensate drain pipe along its entire length is at least the same diameter as the drain line?	<input type="checkbox"/>	<input type="checkbox"/>
Did you check to ensure the condensation drain lines are protected from freezing?	<input type="checkbox"/>	<input type="checkbox"/>
Have you verified the condensate drain line is not plumbed with the pressure relief valve?	<input type="checkbox"/>	<input type="checkbox"/>

<b>CONDENSATE DRAIN (Continued)</b>		
Have you confirmed the condensate drain line is not connected with an air conditioning evaporator coil drain?	<input type="checkbox"/>	<input type="checkbox"/>
This boiler has an integrated condensate trap. Have you verified that an external condensate trap is not installed?	<input type="checkbox"/>	<input type="checkbox"/>
Have you confirmed the end of the condensate drain pipe is open to atmosphere?	<input type="checkbox"/>	<input type="checkbox"/>
Has an air gap been installed in the condensate drain line?	<input type="checkbox"/>	<input type="checkbox"/>
<b>PRESSURE RELIEF VALVE (PRV)</b>	<b>YES</b>	<b>NO</b>
Does the PRV comply with the standard for <i>Relief Valves and Automatic Gas Shutoff Devices for Hot Water Supply Systems ANSI Z21.22</i> , and/or the standard <i>Temperature, Pressure, Temperature and Pressure Relief Valves and Vacuum Relief Valves, CAN1-4.4</i> ?	<input type="checkbox"/>	<input type="checkbox"/>
Did you verify the DHW PRV is rated up to 150 psi and (at least) the maximum Btu/hr of the boiler and the heating system PRV rated to 30 PSI?	<input type="checkbox"/>	<input type="checkbox"/>
Is the discharge from the PRV piped to the ground or into a drain system as per local codes?	<input type="checkbox"/>	<input type="checkbox"/>
Is the discharge line from the PRV pitched downward and does it terminate 6 in. (152 mm) above the drains?	<input type="checkbox"/>	<input type="checkbox"/>
Is the discharge end of the line plain (unthreaded) and a minimum of 3/4 in. diameter?	<input type="checkbox"/>	<input type="checkbox"/>
Is the discharge line material suitable for at least 180° F water?	<input type="checkbox"/>	<input type="checkbox"/>
Did you take measures to protect the PRV and PRV discharge line from freezing?	<input type="checkbox"/>	<input type="checkbox"/>
Have you verified the PRV <b>is not</b> plumbed with the condensate drain line?	<input type="checkbox"/>	<input type="checkbox"/>
Have you verified the PRV <b>is not</b> plugged and that reducing fittings, valves, or other restrictions are not installed in the relief line?	<input type="checkbox"/>	<input type="checkbox"/>
<b>GAS SUPPLY</b>	<b>YES</b>	<b>NO</b>
Did you verify the gas system is appropriately sized?	<input type="checkbox"/>	<input type="checkbox"/>
Did you verify the boiler is rated for the gas type supplied?	<input type="checkbox"/>	<input type="checkbox"/>
Have you performed a gas line and connection leak test?	<input type="checkbox"/>	<input type="checkbox"/>
Did you install a manual gas control valve in the gas line to the boiler?	<input type="checkbox"/>	<input type="checkbox"/>
When the boiler is in operation, is the inlet gas pressure within limits?	<input type="checkbox"/>	<input type="checkbox"/>
Did you purge the gas line of any debris before connecting the boiler?	<input type="checkbox"/>	<input type="checkbox"/>
<b>POWER SUPPLY</b>	<b>YES</b>	<b>NO</b>
Did you confirm that the electricity is supplied from 120 VAC, 60 Hz power source and is in a properly grounded circuit?	<input type="checkbox"/>	<input type="checkbox"/>
Did you confirm that an extension cord or an adapter plug has NOT been used with the boiler?	<input type="checkbox"/>	<input type="checkbox"/>
<b>COMMISSIONING</b>	<b>YES</b>	<b>NO</b>
Did you prime the pump?	<input type="checkbox"/>	<input type="checkbox"/>
Was the boiler filled to 17-26 PSI?	<input type="checkbox"/>	<input type="checkbox"/>
Was the air purge process performed on the boiler?	<input type="checkbox"/>	<input type="checkbox"/>

# 12 Operation

## Topics in this section

- Start-Up Information
- Control Panel
- Basic Operation Settings
- Parameter Settings
- Outdoor Reset Control
- Diagnostic Codes
- Forced Hi/Low Fire Modes
- Freeze Protection

## 12.1 Start-Up Information



### IMPORTANT

- On initial startup of the system, it is necessary to put the boiler into an air purge process to remove all air from the system piping and boiler. The boiler will not immediately fire up and begin operation. The boiler will go into an automatic de-aeration program that is approximately 7 minutes in duration.
- It can take up to a week before all the air has disappeared from a newly-filled and pressurized installation. During the first week of operation, noises can be heard which indicate the presence of air. The automatic air vent in the boiler and air separator in the heating system will remove the air, which means the water pressure will reduce some during this period; therefore, additional water is necessary to maintain proper pressure in the heating system. Water pressure needed for operation:
  - The boiler is in normal operation between 14 PSI and 43.5 PSI.
  - Below 10.1 PSI, the boiler will have an error code (Fault 108 on the display) and be blocked from operation. Increasing the heating system water pressure will be necessary for operation.
  - Between 10 PSI and 14 PSI, operation will be limited to 80% (Alert Warning 1P4 will appear on the display).
  - Above 43.5 PSI, the boiler will have an error code (Fault 109 on the display) and be blocked from operation as the pressure is too high.
    - The maximum pressure permitted inside the heat exchanger is 45 PSI.
    - The pressure relief valve supplied with the boiler is rated to 30 PSI.

# 12.2 Control Panel

## 12.2.1 Access the Control Panel

Slowly lower the protective panel on the front cover to access the control panel.

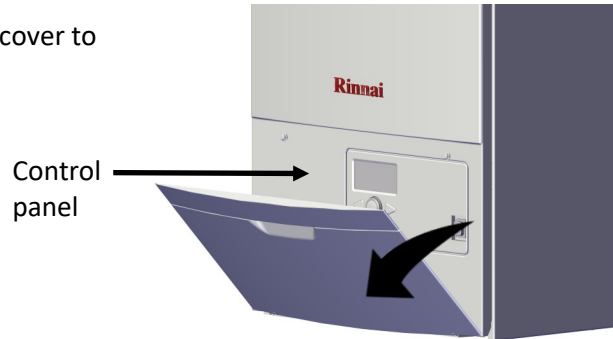

## 12.2.2 Control Panel Features

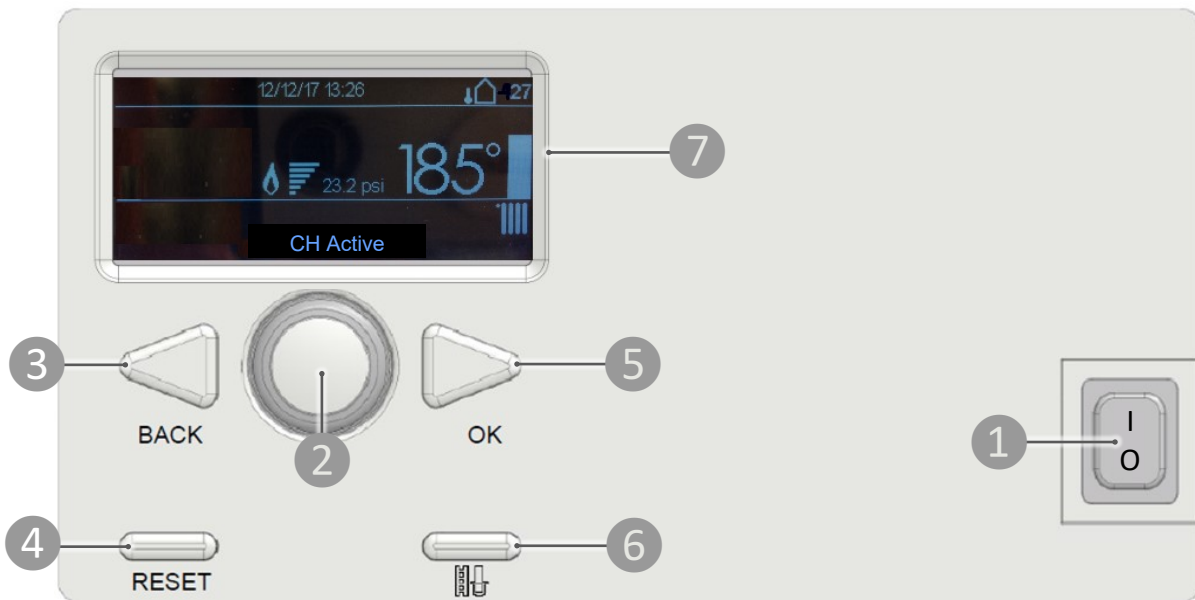

- 1 Power (On/Off)**  
Press to turn the boiler on or off. (I = On O = Off)
- 2 Selector Wheel**  
Turn the wheel left or right to scroll through available menu options
- 3 Back**  
Press to go back one screen.
- 4 Reset**  
Press to reset a fault code.  
*See **Reset Fault Code** section (in this section) for more information*
- 5 OK**  
Press to select an item.
- 6 Chimney Active (Service Mode)**  
Press to enter into service mode which allows adjustment of high fire/low fire and O2 settings.  
*See **Chimney Active (Service Mode)** section (in this section) for more information*
- 7 Boiler Display**  
Displays boiler status information.  
*See **Boiler Display** section (next section) for more information*

## 12.2.3 Display Window

When the boiler is turned on, the main screen (also called the home screen) appears in the display.

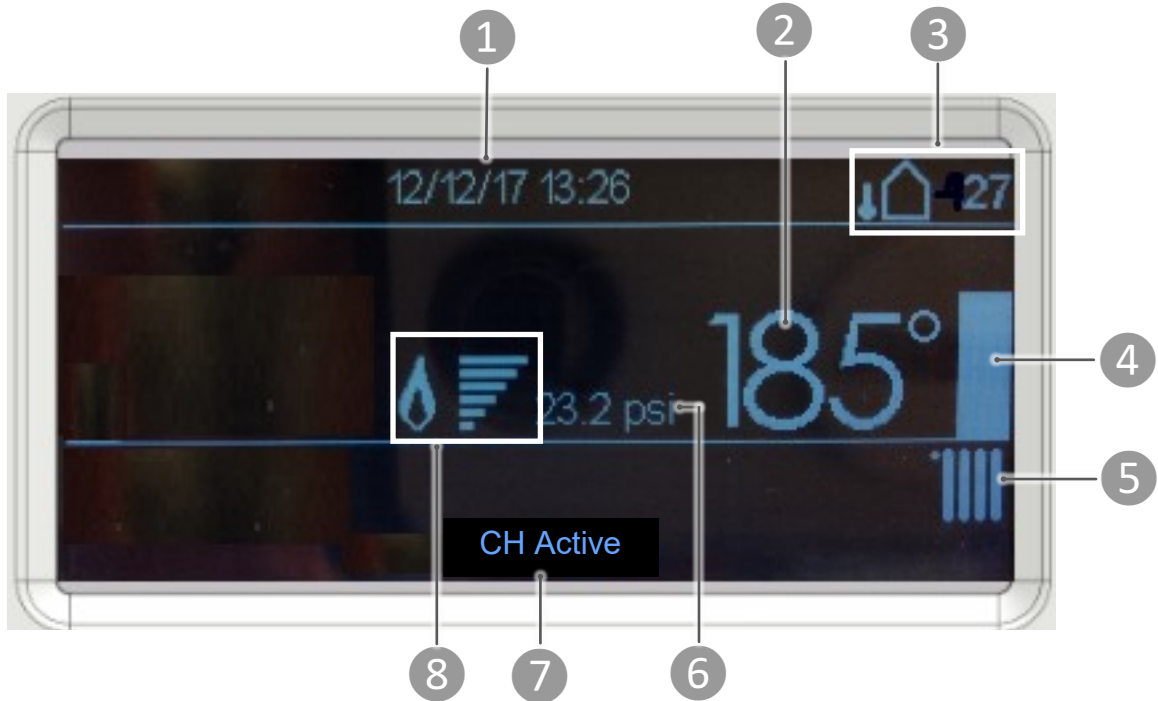

1 Current date and time

2 Heating supply target temperature

3 Outdoor temperature



4 Visual illustration of current central heating temperature

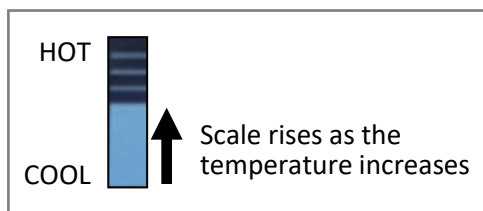

5 Central heating status symbol

A box around the radiator symbol indicates central heating is in operation



CENTRAL HEATING IN OPERATION



CENTRAL HEATING NOT IN OPERATION

6 Current central heating system water pressure

7 Boiler status indicator, such as Central Heating is active, error messages, and other status information

8 Fire level status



High fire (maximum of six bars)

Low fire

## 12.2.4 Change the Language

To change the language appearing on the boiler display, follow the steps below.

1. From the controller Home screen, press **OK**.
2. Turn the selector wheel to highlight **Complete Menu**. Press **OK**.
3. Turn the selector wheel to highlight **Screen Settings**. Press **OK**.
4. **Language** is highlighted. Press **OK**.
5. Turn the selector wheel to highlight the desired language and press **OK**.
6. The language is changed. To exit, press the **Back** button until the **Home** screen appears on the display.



## 12.2.6 Change Units of Measurement

To change the unit of measurements appearing on the boiler display, follow the steps below.

1. From the controller Home screen, press **OK**.
2. Turn the selector wheel to highlight **Complete Menu**. Press **OK**.
3. Turn the selector wheel to highlight **Screen Settings**. Press **OK**.
4. Turn the selector wheel to highlight **System measurement unit**. Press **OK**.
5. Select **International System** or **USA System**.

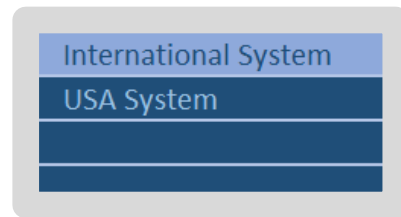

6. Press **Save**.
7. To exit, press the **Back** button until the **Home** screen appears on the display.

## 12.2.5 Change the Time and Date

To change the time and date appearing on the boiler display, follow the steps below.

1. From the controller Home screen, press **OK**.
2. Turn the selector wheel to highlight **Complete Menu**. Press **OK**.
3. Turn the selector wheel to highlight **Screen Settings**. Press **OK**.
4. Turn the selector wheel to highlight **Time & Date**. Press **OK**.
5. Edit the following screen.

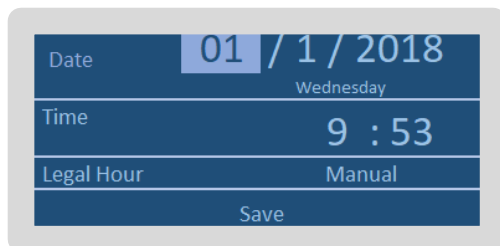

6. Press **Save**.
7. To exit, press the **Back** button until the **Home** screen appears on the display.

### NOTE

The International System selection uses °C and bar for temperature and pressure values respectively, while the USA System uses °F and PSI.



## 12.3 Basic Operation Settings

### 12.3.1 Turn the Boiler On or Off

To turn the boiler on or off, press the Power switch.

I = On    O = Off

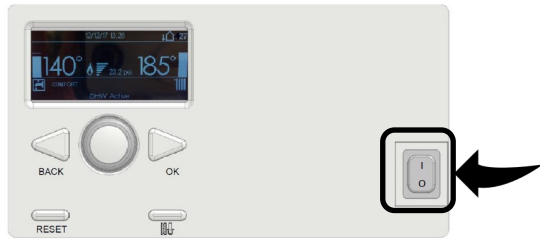

### 12.3.2 Change the Central Heating Target Temperature

**1** From the controller Home screen, press **OK**.

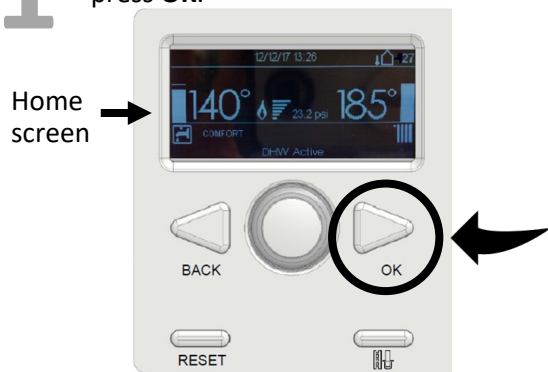

**2** Turn the selector wheel to highlight **Complete Menu**. Press **OK**.

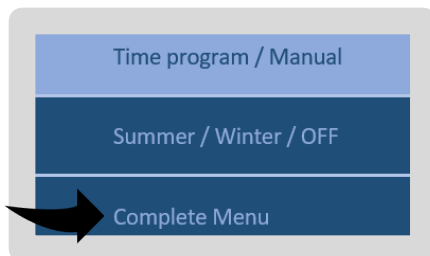

**3** **CH Settings** is highlighted. Press **OK**.

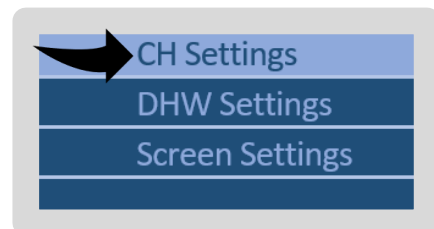

**4** **CH Setpoint Temp** is highlighted. Press **OK**.

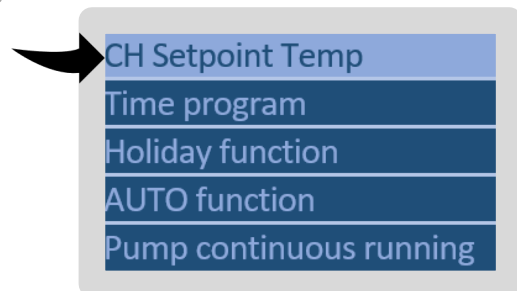

- 5** The option **T set Z1** is highlighted. Press **OK**.

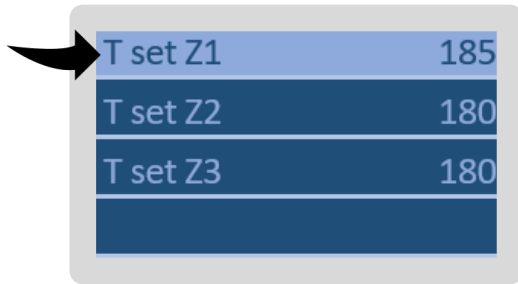

NOTE: Z2 and Z3 are not active controls on this boiler.

- 6** Turn the selector wheel to until the desired target CH temperature appears on the display. Press **OK**.

Available temperature settings (minimum to maximum): 68°F - 185°F (20°C - 85°C)

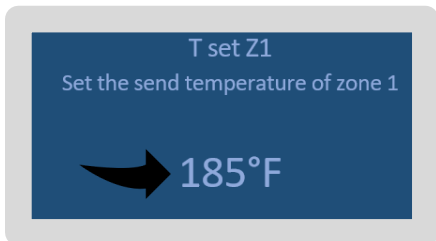

- 7** Press the **Back** button until the Home screen appears on the display.



## 12.3.3 Change the Domestic Hot Water Target Temperature

For use with an external indirect tank.

- 1** From the controller Home screen, press **BACK**.

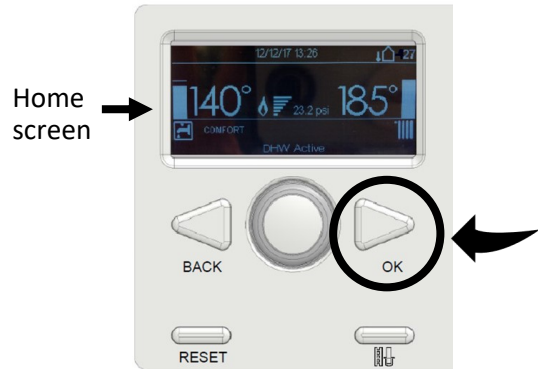

- 2** Turn the selector wheel to the desired DHW setpoint temperature. The boiler will automatically save the new setpoint temperature after five seconds.

# 12.4 Parameter Settings

## 12.4.1 Parameter Settings Table

### Boiler Parameters

PARA	Default	Range	Description
2.0.0	140°F	104 - 140°F	DHW setpoint temp (also achieved by pressing BACK and turning dial on home screen)
2.0.3	194°F	176 - 194°F	Max Water Temp (absolute max) Will limit outdoor reset curve settings
2.0.4	0	0-10,200	Will allow you to set higher than 10.2K but no effect
2.0.6	9°F/min	0-27°F/min	How quickly boiler reaches setpoint from cold start
2.2.4	ON	ON/OFF	AUTO function is the outdoor reset control. Changing this to the off setting turns off outdoor reset and enables simple setpoint CH supply temperature control. (Also available from AUTO function in main menu (CH) or 4.2.1)
2.2.8	0 – Combi 2 – Solo	0=all Combi models 1=Solo boiler with 10KΩ NTC thermistor in DHW indirect tank 2=Solo boiler with aquastat in DHW indirect tank	
2.4.9	0	-5 to +5°F	Outdoor reset temp sensor correction May need if outdoor reset is in direct sunlight, etc.
2.5.0	0	0=Eco (off) 1=Schedule 2=Comfort	DHW Comfort Mode Also available from home screen (DHW)
2.5.7	1	0=OFF 1=ON	Anti-legionella Cycle (Solo models only)
2.6.0	OFF	ON/OFF	Activates manual mode for component testing
2.6.1	OFF	ON/OFF	Manual control of pump with burner off
2.6.2	OFF	ON/OFF	Manual control of fan with burner off
2.6.3	OFF	ON/OFF	Manual control of 3-way valve with burner off
2.7.0	OFF	ON/OFF	Forces chimney mode (same as button)
2.7.1	OFF	ON/OFF	Forces Air purge (or turn off – same as holding BACK for 7 seconds)
2.8.0	NA	OK=YES ESC=NO	Resets all parameters to factory defaults (green button)
2.9.0	1	0=NO 1=NC	External Safety contact (LWCO, etc) (NOTE: DO NOT USE OPTION 2)
2.9.1	1	0=OFF 1=ON	System (plant) frost protection, pump operation based on outdoor temp sensor value

## Heating Parameters

<b>PARA</b>	<b>Default</b>	<b>Range</b>	<b>Description</b>
4.2.0	1	0=Low Temp 1= High Temp	Outdoor reset curve presets
4.2.1	3	0=OFF 3=ON	Thermoregulation: outdoor temperature reset Also available from AUTO function in main menu (CH) or 2.2.4 DO NOT USE 1,2, or 4
4.2.2	LT=0.8 HT=2.0	LT=0.2-1.0 HT=1.0=3.5	Slope of outdoor reset curve (see separate slides), depends on 4.2.0 setting
4.2.3	0	Depends on curve settings	Heating curve offset (parallel shift)
4.2.5	LT=122°F HT=185°F	LT=68-122°F HT=68-185°F	Maximum supply temp (°F)
4.2.6	68°F	LT=68-122°F HT=68-185°F	Minimum supply temp (°F)

## Service Parameters

<b>PARA</b>	<b>Unit</b>	<b>Description</b>
8.0.1	Hours	Total pump hours
8.0.3	Hours	Total hours boiler on power (electricity)
8.0.4	Hours	Total fan hours
8.0.5	Cycles	Total fan cycles
8.0.6	Cycles	Total CH flame ignitions
8.0.7	Cycles	Total DHW flame ignitions
8.1.0	Hours	Total CH burner hours
8.1.1	Hours	Total DHW burner hours (add w/CH for absolute total)
8.1.2	Occurrence	Total number of flame faults
8.1.3	Cycles	Total ignition cycles
8.2.1	OFF/ON	PCB signal if fan is ON or OFF
8.2.2	RPM	Fan speed
8.2.3	0-100%	Pump speed
8.2.4	3-way valve position	0=DHW, 1=CH
8.2.5	l/min	DHW rate (note this is in liters multiply by .264 for GPM)

Service Parameters (Continued)

<b>PARA</b>	<b>Unit</b>	<b>Description</b>
8.2.7	%	Pump modulation (will never read above 90%)
8.2.8	kW	Boiler power during operation (multiply by 3412 for BTU)
8.2.9	PSI	Actual PSI (also on home screen)
8.3.0	°F	CH Flow Setpoint, also called T-set
8.3.1	°F	T1 (Supply temp)
8.3.2	°F	T2 (Return temp)
8.3.3	°F	T3 combi (DHW temp)
8.3.5	°F	Outdoor temp sensor (also on home screen)
8.4.0	°F	Indirect tank temp
8.5.0	Months	Maintenance frequency
8.5.1	ON/OFF	Maintenance frequency activation
8.5.2	0/1	Maintenance frequency reset
8.5.4		Software Version (display board)
8.5.5		Software version (main PC Board)
8.7.5		Flame Rod Current

## 12.4.2 Parameter Adjustment

To follow is an example of how to adjust parameters on the M-Series Boiler.

### Change the Altitude

- 1 From the controller **Home** screen, press the **BACK** and **OK** buttons at the same time for 7 seconds.

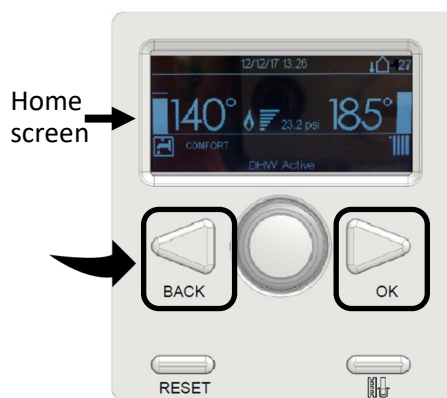

- 2 Turn the selector wheel so that **007** appears as the technical code.

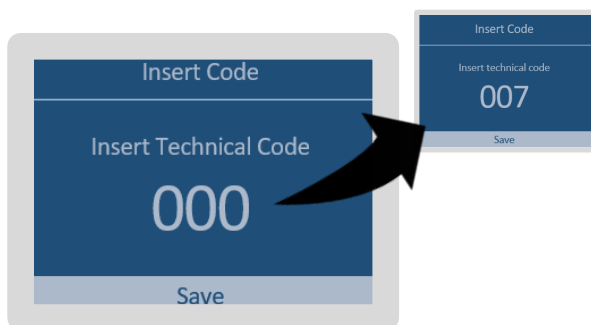

The "007" Menu is where all parameters can be adjusted.

- 3 Turn the selector wheel to highlight **Complete Menu**. Press **OK**.

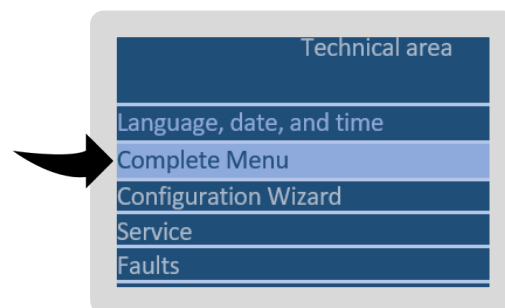

All commonly adjusted parameters can be accessed in the **Complete Menu**.

- 4 Turn the selector wheel to highlight **2 Boiler Parameters**. Press **OK**.

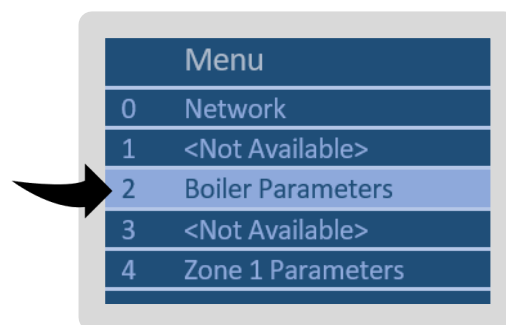

The first digit shown is the first value in the parameter address in the table to follow.

5 Option **2.0 General** is highlighted. Press **OK**.

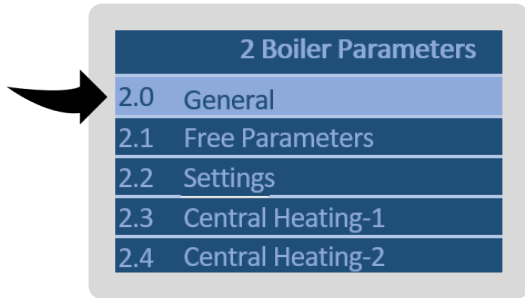

6 Turn the selector wheel to highlight **2.0.4 Altitude**. Press **OK**.

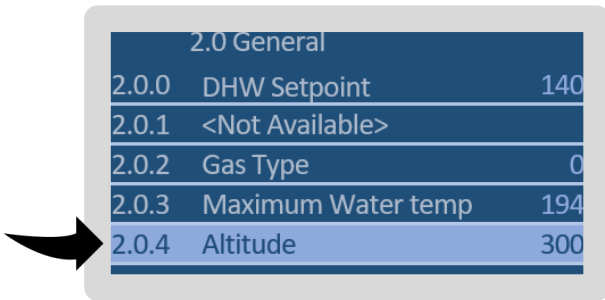

7 Scroll to the desired altitude and press **OK**.

**Note:** Altitude is displayed in feet (ft) measurements.

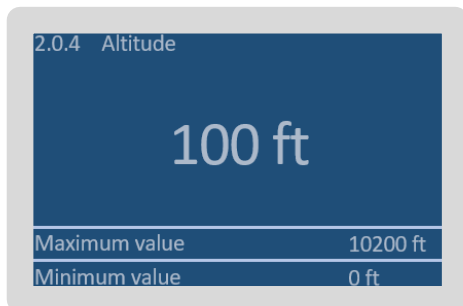

The parameter had now been updated to the set value.

8 Press the **Back** button until the **Home** screen appears on the display.



## 12.5 Outdoor Reset Control

Outdoor reset is a built-in function to help maximize the efficiency of the boiler. The design of this function is to adjust the target temperature of the boiler relative to the outdoor ambient temperature via the four outdoor reset curve options included in the boiler parameters. The outdoor ambient temperature is observed via the provided outdoor temperature sensor.

### 12.5.1 Outdoor Temperature Sensor

The outdoor temperature sensor should be mounted on a North facing wall of the house below an eave to avoid direct sunlight (to prevent obtaining a false reading of the outdoor temperature). The sensor should also be mounted away from any vent, duct, or other device that may create an artificial heat source. The sensor should then be wired back to the outdoor temperature sensor terminal on the boiler. Refer to the following sections for more information.

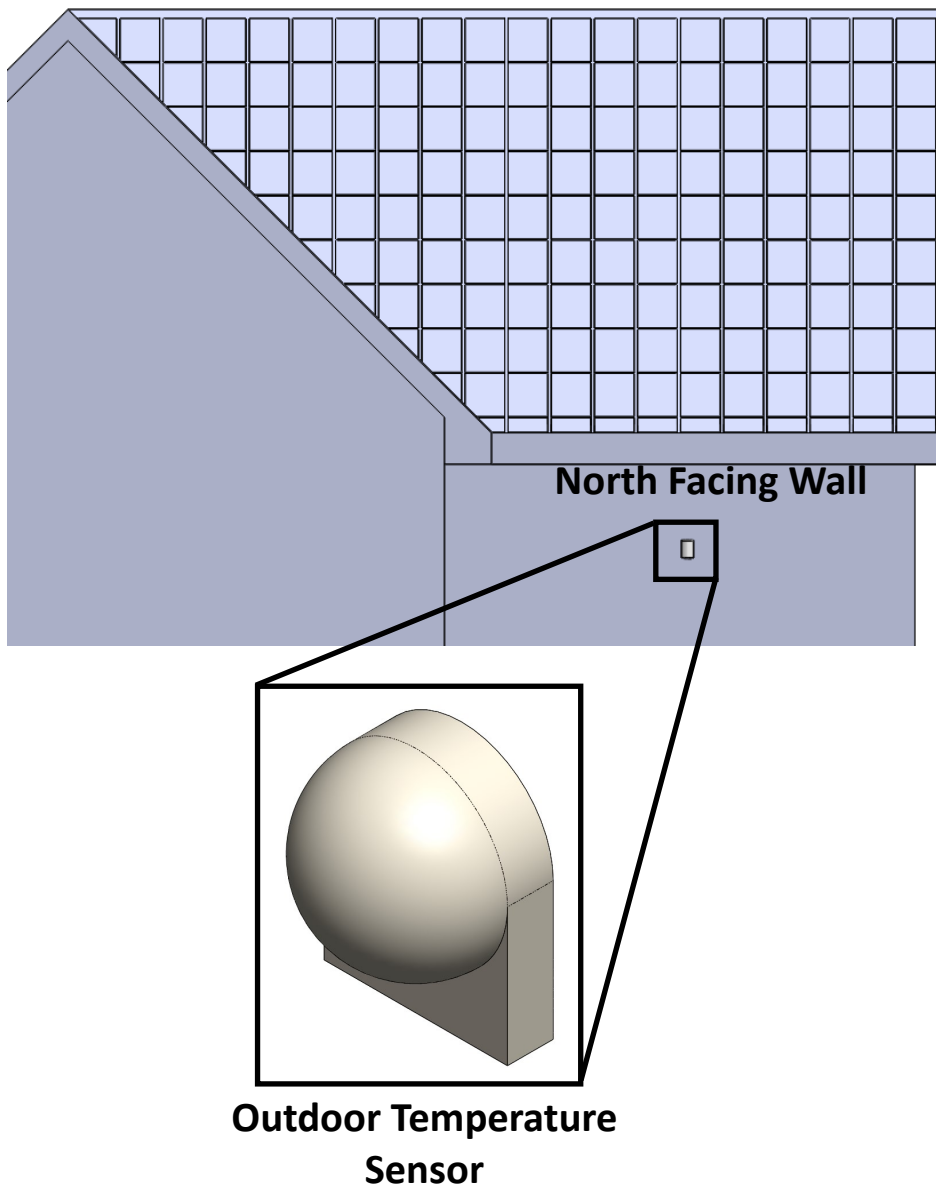



## 12.5.2 Outdoor Reset Connection

1. Remove the boiler's front panel by removing the four screws that secure the panel.
2. Locate the HMI at the bottom of the unit.
3. Connect the outdoor sensor to the terminals shown.
4. Set parameters 4.2.0-4.2.6 as appropriate for your application (see section "12.4.1 Parameter Settings Table" for more information).

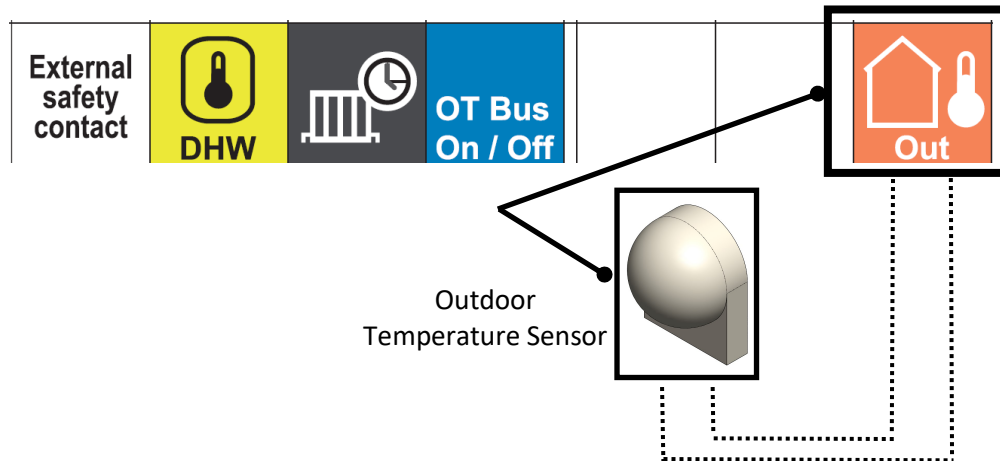

## 12.5.3 Outdoor Reset Curves

The boiler comes equipped with several outdoor reset curves, which are different target temperature lines dependent on the outdoor temperature. The selected curve should be based off of the type of heat emitter and the target temperature desired. The steeper the curve (higher the value) the quicker the system will come up to temperature. The high temperature curve is default. It is recommended to use this for all applications except in-floor/slab radiant.

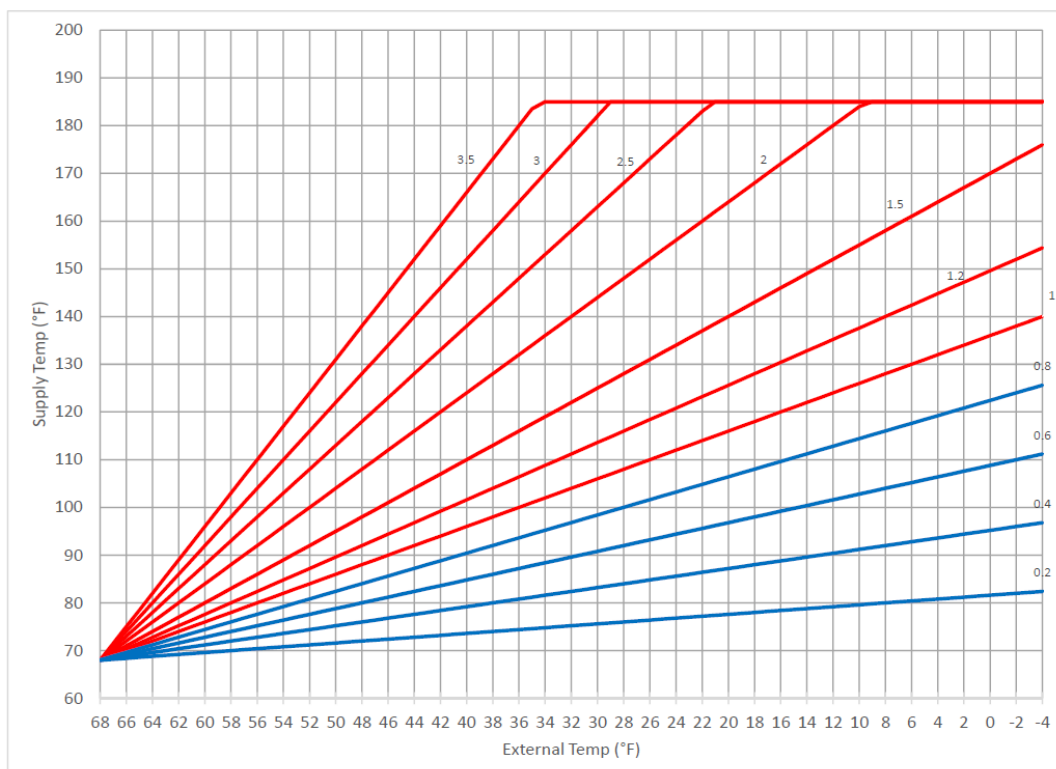

## 12.5.4 Outdoor Reset Curve Temperature Guidelines

Below are some typical target temperatures for various heat emitters.

Type of Heat Emitter	Typical Minimum Supply Temperature	Typical Maximum Supply Temperature
Hydronic Air Handler	120 - 140°F	140 - 180°F
Unit Heater	130 - 140°F	160 - 180°F
Base Board convectors	100 - 140°F	140 - 190°F
Cast Iron / Panel Radiator	90 - 120°F	140 - 180°F
Undermount Radiant	100 - 120°F	120 - 150°F
Poured concrete radiant	80 - 90°F	110 - 130°F

\*NOTE: These are basic guidelines. Please check with manufacturer of emitter or consult your heating design engineer.

Below are parameter locations and explanations of outdoor reset parameters that will need to be adjusted upon installation.

Key Outdoor Reset Parameters		
Parameter Address	Description	Value
4.2.0	Curve Presets	1=High temperature, (all apps except in-floor (slab) radiant applications)
		2= Low temperature, (in-floor) slab radiant apps
4.2.2	Slope	High value = steep slope
		Low value = gradual slope
4.2.5	Maximum temperature	Raises / lowers maximum target supply temperature
4.2.6	Minimum temperature	Raises / lowers minimum target supply temperature and outdoor reset curve.

## 12.6 Diagnostic Codes

 <b>WARNING</b>	Some of the checks below should be performed by a licensed professional. Consumers should never attempt any action that they are not qualified to perform.
--	--

When the boiler detects an error, a 3-digit blocking or fault code appears on the controller display.

- A blocking code is a temporary error that can be automatically corrected by the boiler.
- A fault code requires the error to be reset and/or corrected for the boiler to go back into a normal operating mode. In the table below, fault codes are labeled with “Press the **Reset** button” in the “How to Resolve” column.

An overview of the most common blocking and fault codes are listed below.

Code	Description	Reason(s)	Where Error is Occurring	How to Resolve
101	Overheat	<ul style="list-style-type: none"> <li>• The supply or return water temperature is greater than 212°F for 3 seconds.</li> <li>• The return water temperature is within 9°F of the supply temperature for 24 hours</li> <li>• The supply and return probe check failed</li> </ul>	CH Operation	Press the <b>Reset</b> button
102	Pressure Sensor Damaged	The pressure sensor has a short or open circuit	CH Operation	Troubleshoot the pressure sensor
103	Flow Check Failed 3 Times	Three flow checks failed within 15 minutes. 1P1 (Flow Check 1 Failed) was the last error detected.	CH Operation	Press the <b>Reset</b> button
104	Flow Check 2 Failed	More than 27°F per second change in supply or return water temperature	CH Operation	Press the <b>Reset</b> button
105	Flow Check Failed 3 Times	Three flow checks failed within 15 minutes. 1P3 (Flow Check 4 Failed) was the last error detected.	CH Operation	Press the <b>Reset</b> button
106	Flow Check Failed 3 Times	Three flow checks failed within 15 minutes. 1P4 (Filling Needed) was the last error detected.	CH Operation	Press the <b>Reset</b> button
107	Flow Check 5 Failed	The return water temperature is more than 63°F higher than the supply water temperature and the burner is on	CH Operation	Press the <b>Reset</b> button
108	Supply Pressure is below Minimum Pressure	<ul style="list-style-type: none"> <li>• The supply pressure is below minimum pressure and the burner is on</li> <li>• The burner is off with the supply pressure below the minimum pressure and air purge is active for 40 seconds</li> </ul>	CH Operation	Raise the supply pressure above the minimum pressure
109	Supply Pressure is above Maximum Pressure	The supply pressure is above the maximum pressure	CH Operation	Lower the pressure to 4.3 PSI below the maximum supply pressure. Verify proper operation of the PRV.
110	Send Probe Damaged	The supply sensor has a short or open circuit	CH Operation	Troubleshoot the supply sensor
112	Return Probe Damaged	The return sensor has a short or open circuit	CH Operation	Troubleshoot the return sensor
114	Outdoor Probe Damaged	The outdoor sensor is installed and has a short or open circuit	CH Operation	Troubleshoot the outdoor sensor

Code	Description	Reason(s)	Fault Location	How to Resolve
1P1	Flow Check 1 Failed	Change in supply temperature of 12.6° F to 27° F in one second	Central Heating operation	The boiler will attempt to correct for 10 seconds
1P2	Flow Check 3 Failed	The supply water temperature is more than 99°F higher than the return water temperature	Central Heating operation	The boiler will attempt to correct for 10 seconds
1P3	Flow Check 4 Failed	The return water temperature is 18° F higher than the supply water temperature	Central Heating operation	The boiler will attempt to correct for 10 seconds
1P4	Filling Needed	Supply pressure is below the warning pressure	Central Heating operation	Raise the supply pressure above the minimum pressure
201	Combi Domestic Hot Water NTC Damaged	The Domestic Hot Water sensor has a short or open circuit	Domestic Hot Water operation	Troubleshoot the Domestic Hot Water sensor
203	Tank NTC Sensor Damaged	The tank probe has a short or open circuit	Domestic Hot Water operation	Troubleshoot the tank probe
303	PCB Fault	PC board software or hardware error	PC Board	Press the <b>Reset</b> button
304	Too Many Reset	The <b>Reset</b> button was pressed more than 5 times in 15 minutes	PC Board	Wait for 15 minutes to elapse without pressing the <b>Reset</b> button
306	PCB Fault	PC Board error	PC Board	Press the <b>Reset</b> button
309	Gas Relay Check Failed	Flame detected for 3 seconds after the gas valve closed	PC Board	Press the <b>Reset</b> button
3P9	Scheduled Maintenance-Call Service	The maintenance timer has expired	PC Board	Reset the monthly timer for the next maintenance interval reminder
501	No Flame Detected	Flame not detected	Flame ignition/detection	Press the <b>Reset</b> button
502	Flame Detected with Gas Valve Closed (False Flame)	Flame detected before the gas valve opened	Flame ignition/detection	Troubleshoot the flame rod, igniter, electrode, and gas valve
504	Flame Lift	Loss of flame during burner operation	Flame ignition/detection	Press the <b>Reset</b> button
5P1	1stIgnit Failed	Flame not detected during the first ignition attempt	Flame ignition/detection	Fault will go away at the end of the second ignition attempt
5P2	2ndIgnit Failed	Flame not detected during the second ignition attempt	Flame ignition/detection	Fault will go away at the end of the third ignition attempt
5P3	Flame Lift	Loss of flame during burner operation	Flame ignition/detection	Fault will go away with proper ignition
612	Fan Error	Fan speed is too high or too low	Fan/Vent	Press the <b>Reset</b> button
1P9	Water Pressure Dynamic Check	No pressure change after 5 seconds of running the pump	Central Heating operation	The boiler will check the pressure for 30 seconds and the error will go away with proper inlet pressure
140	Water Pressure Dynamic Check	Two 1P9 water pressure checks failed	Central Heating operation	Press the <b>Reset</b> button

## 12.6.1 Reset a Diagnostic Code

- 1** When an error occurs, the fault code and description appear on the display.

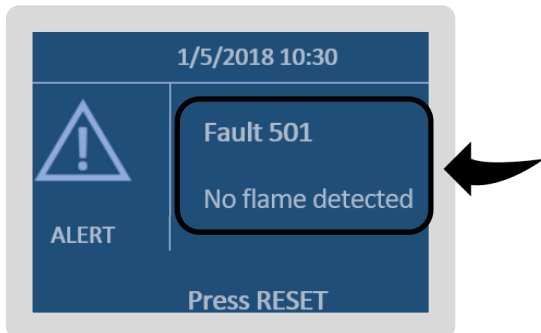

- 2** To reset the fault code, press the **RESET** button.

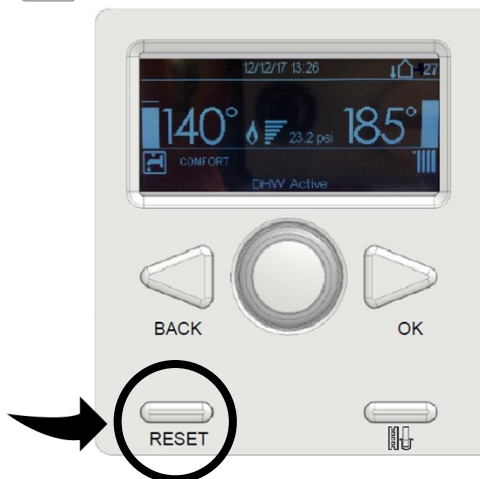

- 3** The following message appears:  
**Do you really want to perform the reset?**

- Press **OK** to reset the error
- Press the **ESC** keyboard button to cancel reset and return to the previous screen

Do you really want to perform the reset? If you press OK button, the reset command will be executed otherwise, by way of ESC, the previous page is shown.

- 4** The **Reset in Progress** message appears.

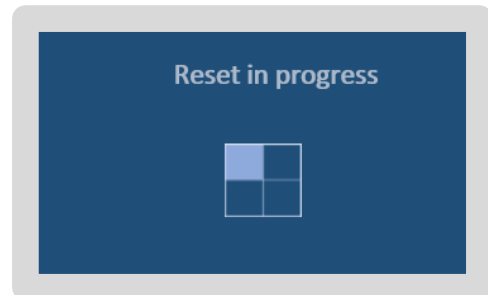

- 5** The **Fault Solved** message appears.

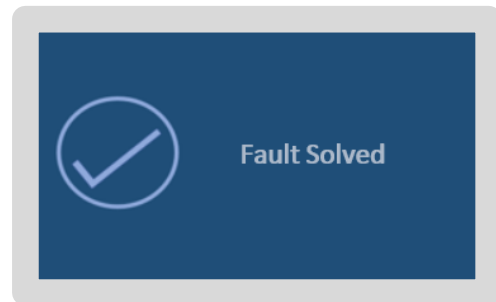

- 6** After the code is reset, the Home screen automatically appears.



## 12.6.2 View Diagnostic Code History

- 1** From the controller **Home** screen, press the **BACK** and **OK** buttons at the same time for 7 seconds.

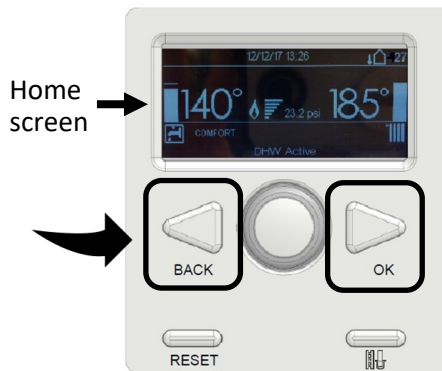

- 2** Turn the selector wheel so that **007** appears as the technical code.

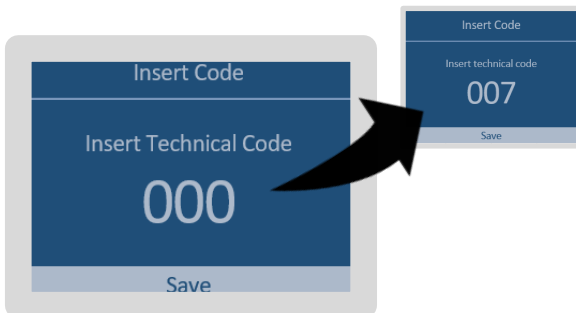

- 3** Turn the selector wheel to highlight **Complete Menu**. Press **OK**.

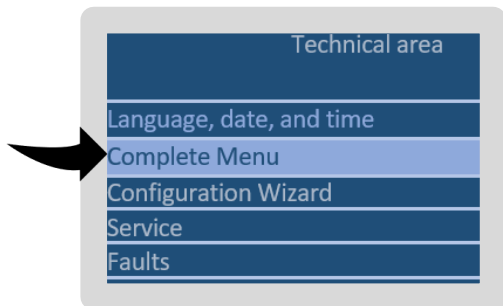

- 4** Turn the selector wheel to highlight **8 Service Param**. Press **OK**.

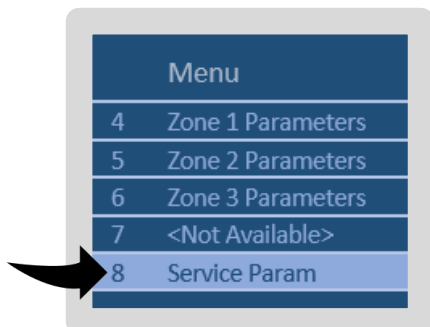

- 5** Turn the selector wheel to highlight **8.6 Error History**. Press **OK**.

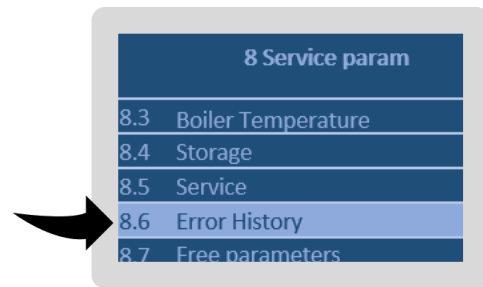

- 6** Option **8.6.0 Last 10 Errors** is highlighted. Press **OK**.

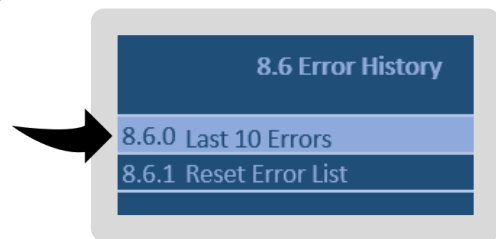

- 7** Scroll to view the last 10 errors.

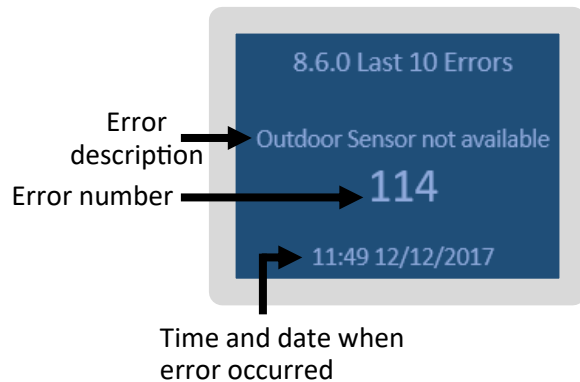

# 12.7 Forced High/Low Fire Modes

## Chimney Active (Service Mode)

**WARNING** This section should be performed by a licensed professional. Consumers should never attempt any action that they are not qualified to perform.

The Chimney Active (service mode) button puts the boiler into service mode which allows adjustment of high fire/low fire and O2 settings. To enter Chimney Active (service mode):

**1** From the controller **Home** screen, press and hold the **Chimney Active** button for approximately 7 seconds.

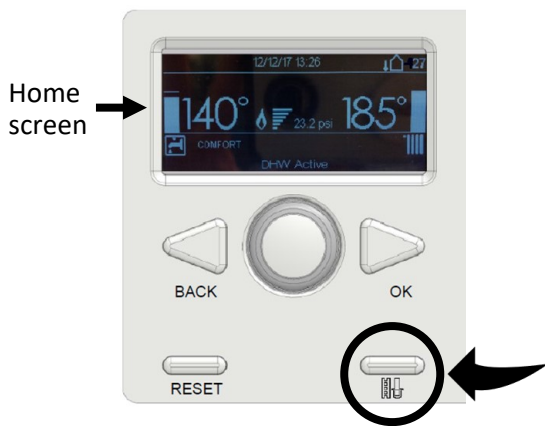

**2** The following screen appears indicating that Chimney Active (service mode) is active.



**3** Chimney Active (service mode) defaults to 100%.

Use the selector wheel to adjust between 0% to 100% and then press **OK**.

- 0% (boiler will run on low fire/low load)
- 100% (boiler will run on maximum fire/full load)

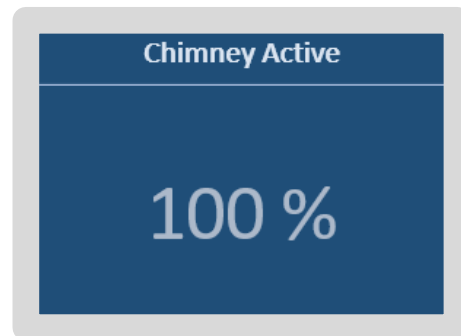

**4** To exit Chimney Active (service mode), press the **Back** button until the **Home** screen appears on the display.



## 12.8 Freeze Protection

The boiler is equipped with two different methods of freeze protection, one for the boiler itself and one for the system.

### 12.8.1 Boiler Freeze Protection

---

If the Supply Temperature thermistor, T1, observes a temperature less than 47°F, the boiler pump will run for 2 minutes. The internal three way valve will alternate every minute to ensure circulation through both the primary heat exchanger and the plate heat exchanger. If T1 observes a temperature less than 39°F, the burner will fire for 30 seconds or until the T1 sensor observes a temperature higher than 47°F. This feature cannot be disabled.

### 12.8.2 System Freeze Protection

---

If the outdoor sensor observes a temperature between 25°F and 35°F, the boiler will operate for 10 minutes every 6 hours. If the outdoor sensor observes a temperature of 24°F or less, the boiler pump will run continuously. This feature can be disabled via parameter 2.9.1.

### 12.8.3 System Drain

---

When the system needs to be shutdown for extended periods of time, the boiler and all system piping should be drained. The power and gas supply should then be disconnected from the boiler. Freezing damage may occur if there is water remaining in the boiler or system piping. The plumbing lines should also be blown out via compressed air.



# 13 Maintenance

## Topics in this section

- Owner Maintenance
- Licensed Professional Maintenance
- Test the Ignition Safety Shut Off Device

### WARNING

- Maintenance is required to maintain safe operation of the boiler.
- The boiler must be inspected annually by a licensed professional. Repairs and maintenance shall be performed by a licensed professional. The licensed professional must verify proper operation after servicing.
- Keep the boiler area clear and free from combustible materials, gasoline, and other flammable vapors and liquids.
- To protect yourself from harm, before performing maintenance:
  - Turn off the electrical power supply by unplugging the power cord or by turning off the electricity at the circuit breaker. (The boiler controller does not control the electrical power.)
  - Turn off the gas at the manual gas control valve, usually located immediately below the boiler.
  - Turn off the incoming water supply. This can be done at the isolation valve immediately below the boiler or by turning off the water supply to the building.

## 13.1 Owner Maintenance

### WARNING

If you encounter a problem that is difficult to solve, stop the operation and immediately contact a licensed professional.

#### MONTHLY

##### Boiler Area

- Verify the area is free of combustible materials, gasoline and other flammable vapors and liquids.
- Verify the area is clean from dust and obstructions
- Verify the air intake area is free of any contaminants listed in the boiler Installation and Operation Manual. Any contaminants in the boiler intake air vicinity must be removed. If they cannot be removed, contact a licensed professional.

##### Piping

- Inspect all water, gas, and condensation piping for leaks. Look for signs of leaking lines or corrosion.
- Confirm the condensation line is not blocked. If a condensation drain pump is used, confirm the condensation drain pump operates correctly.

##### Venting

- Verify the boiler vent discharge and air intake is clean and free of obstructions.
- Check for leakage, damage, or deformation of venting.

##### Boiler

- Verify the boiler is free from any abnormal situations, such as diagnostic error codes, loud noises, leakage or other potential issues.
- Check that the pressure on the controller display or external pressure gauge indicates 19-43.5 psi.

## 13.2 Licensed Professional Maintenance

TWO YEAR SERVICE	
<b>Vent System</b>	<ul style="list-style-type: none"> <li>• Inspect for blockages or damage.</li> <li>• Inspect vent screen or room air filter (if using) for debris and blockages. Clean if needed.</li> </ul>
<b>Fan and Motors</b>	Clean dust and dirt from fan and motor (motors are permanently lubricated and do not require lubrication).
<b>Controller</b>	Check diagnostic code history.
<b>Pressure</b>	Confirm the pressure is within the proper range (between 17-26 PSI). If the pressure is lower than the specified range, add water until in the proper range.
<b>Pressure Relief Valve</b>	<p>Operate the pressure relief valve manually once a year. In doing so, it will be necessary to take precautions with regard to the discharge of potentially scalding hot water under pressure. Ensure discharge has a safe place to flow. Contact with your body or other property may cause damage or harm.</p> <div style="border: 1px solid black; padding: 5px; margin-top: 10px;"> <p> <b>WARNING</b> Testing the pressure relief valve should only be performed by a licensed professional. Water discharged from the pressure relief valve could cause severe burns instantly or death from scalds.</p> </div>
<b>Expansion Tank</b>	Perform annual checks as recommended by the manufacturer to ensure proper operation.
<b>Condensation Trap</b>	Check if the trap contains sediment. To remove sediment, unplug the bottom of the condensate trap. Remove the sediment, and then return the plug. Do not use a wrench to tighten the condensate drain as this could cause the connection to break.
<b>Condensation Drain</b>	<ul style="list-style-type: none"> <li>• Confirm the condensation drain line is not blocked or clogged.</li> <li>• Ensure the condensation drain pump (if utilized) is working correctly.</li> </ul>
<b>Draining Water</b>	When the system will be shutdown for a long period of time (seasonal shutdown), close the shutoff valves below the boiler and drain the boiler to protect it from potential freeze damage.
<b>Water Quality</b>	Confirm the water quality. Refer to section “4.4.1 Water Quality Guidelines” to determine if the water needs to be treated or conditioned. DHW must be potable, free of corrosive chemicals, sand, dirt, or other contaminants. It is up to the installer to ensure the water does not contain corrosive chemicals or elements that can affect or damage the heat exchanger. Water that contains chemicals exceeding the levels required affect and damage the heat exchanger. Replacement of the heat exchanger due to water quality damage is not covered by the warranty.

<b>Snow Accumulation</b>	<ul style="list-style-type: none"> <li>• Verify the area around the flue terminal is free of snow and ice. The boiler will not function properly if the combustion air or exhaust vent pipes are impeded (blocked or partially blocked) by obstructions.</li> <li>• Verify the condensate drain line is free of snow and ice. Ensure the line is not blocked or clogged and that condensate is flowing freely.</li> </ul>
<b>Freeze Protection</b>	<ul style="list-style-type: none"> <li>• Freeze protection for new or existing systems must use glycol that is specially formulated for this purpose. This includes inhibitors, which prevent the glycol from attacking the metallic components. The glycol should be for multi-metallic components. Reference section “14.1 Approved Cleaners, Inhibitors and Antifreezes” in the Appendix for an approved list of system cleaners, inhibitors, and antifreezes.</li> <li>• Check that the system fluid is correct for the glycol concentration and inhibitor level. The system should be tested at least once a year and as recommended by the producer of the glycol solution. The allowed maximum concentration is 50 percent.</li> </ul>
<b>Coast Area Installations</b>	<p>Installations located in or near coastal areas may require additional maintenance due to corrosive airborne ocean salt. If corrosion is observed on the body of the boiler, the boiler shall be inspected to ensure proper operation and repaired or replaced, if necessary.</p>
<b>Cleaning</b>	<p>It is imperative that control compartments, burners, and circulating air passageways of the boiler be kept clean. Check burner flame for proper color. Once ignited, the flame must cover the surface of the burner. The flame must burn with a clear, blue, stable flame. If the flame does not have this appearance, complete the following steps:</p> <ul style="list-style-type: none"> <li>• Turn off and disconnect electrical power. Allow to cool.</li> <li>• Remove the front panel.</li> <li>• Use a vacuum to remove dust from the main burner and fan blades. Do not use a wet cloth or spray cleaners on the burner. Do not use volatile substances such as benzene and thinners; they may ignite or fade the paint.</li> <li>• Do not open the burner cabinet and touch the burner surface.</li> </ul> <p>Condensate Trap Cleaning:</p> <ul style="list-style-type: none"> <li>• Inspect the condensate drain assembly inside the boiler and your external drain system.</li> <li>• Remove any debris that may be present in the condensate removal system.</li> </ul>

#### AFTER SERVICING: VISUAL INSPECTION OF FLAME

Verify proper operation after servicing. The burner must flame evenly over the entire surface when operating correctly. The flame must burn with a clear, blue, stable flame. See the parts breakdown of the burner for the location of the view ports. The flame pattern should be as shown in the images below:

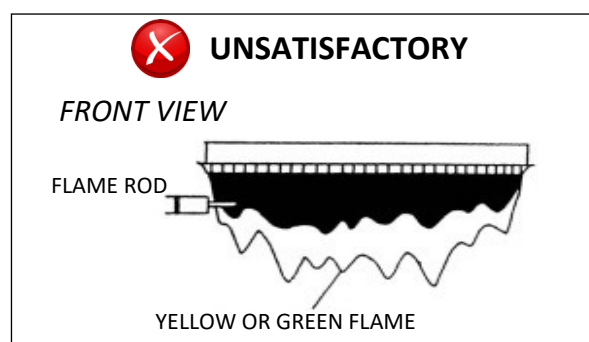
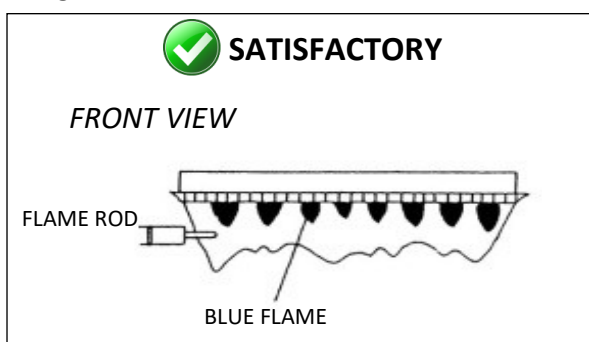

## 13.3 Test the Ignition Safety Shut Off Device

1. Ensure the boiler is not currently firing and the flame rod is not hot.
2. Remove the boiler front panel.
3. Disconnect the wiring connection from the flame rod (located on the left side of the boiler).

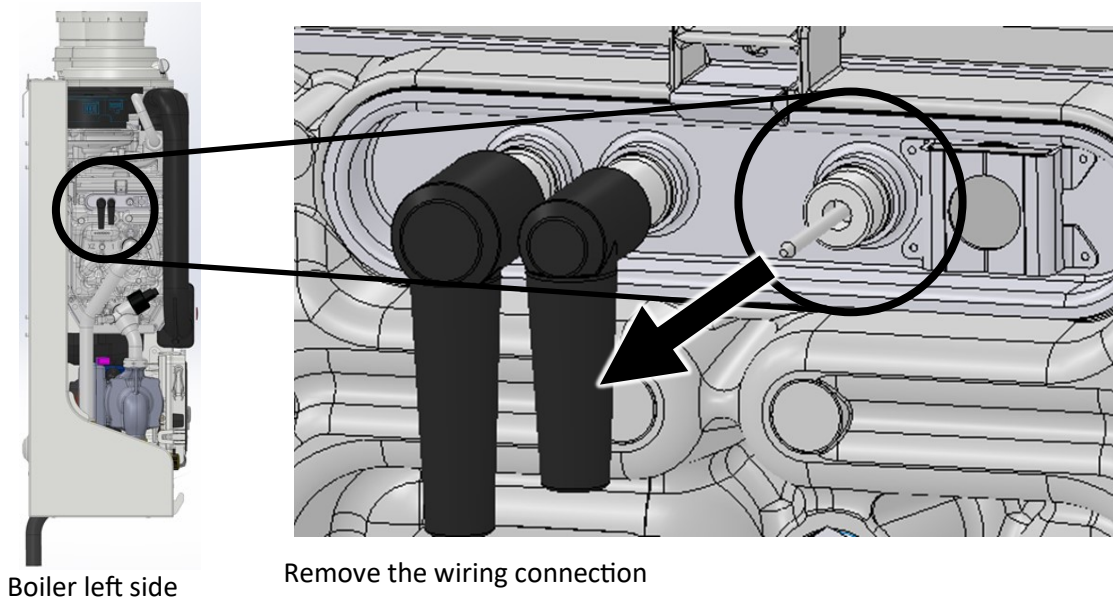

**WARNING** Do not touch the inside of the wiring connection while it is disconnected.

4. On the control panel, press and hold the **Service Mode** button for approximately 7 seconds.



5. The boiler initiates one start-up attempt and four restart attempts. After the last start-up attempt, the boiler locks out and the gas valve shuts off. Code **501 No Flame Detected** appears on the controller display.
6. Reconnect the wiring connection to the flame rod. Be careful not to touch the inside of the wiring connection.
7. Press the **RESET** button on the control panel.



8. The boiler should start up. If the boiler does not start up, contact Rinnai Customer Care at 1-800-621-9419.
9. Replace the boiler front panel.

# 14 Appendices

## 14.1 Approved Cleaners, Inhibitors and Antifreezes

Below is a list of approved system cleaners, inhibitors, and antifreezes for use in hydronic plumbing systems utilizing Rinnai boilers.

### Approved System Cleaners:

- Fernox F3 Cleaner
- Noble Noburst Hydronic System Cleaner
- Rhomar Hydro-Solv 9100
- Sentinel X400

### Approved System Inhibitors:

- Noble Noburst AL Inhibitor
- Rhomar Pro-tek 922
- Sentinel X100

### Approved System Antifreezes:

- Chem Frost 100%
- Fernox Alphi 11
- Hall-Chem Solar II
- Noble Noburst AL
- Rechochem Recofreeze AL
- Rhomar RhoGard Mutli-Metal (AL safe)
- Sentinel X500

### ➔ IMPORTANT

- If replacing a boiler, add system cleaners while the old boiler is installed and operate the old boiler for heating for several days to most effectively clean the system.
- The Rinnai boiler must be closed off (valved off) from the rest of the system, or not connected, while cleaners are in the system.
- When cleaning is complete, drain the system and then flush with clean water to remove any sediment.

## 14.2 Flush the CH Plumbing System

When replacing an existing boiler, the heating system shall be flushed with an approved system cleaner before the new boiler is added to the system. If the old boiler has already been removed, a bypass must be piped in when the new boiler is installed to facilitate the flushing of the system.

The Rinnai boiler must be isolated from the system while the system is flushed. No system cleaner should ever enter the boiler heat exchanger due to its caustic nature which could damage the heat exchanger.

Reference section “14.1 Approved Cleaners, Inhibitors and Antifreezes” in the Appendix for an approved list of system cleaners, inhibitors, and antifreezes.

### Instructions

1. Flush the CH system with water.
2. Isolate the boiler from the CH system.
3. Fill the CH system with an approved cleaner and circulate through the system.
4. If the installation is a zone system (utilizes multiple zones), flush out each zone individually.
5. Flush the CH system with water again, ensuring all zones have been flushed.
6. Clean out the dirt trap per manufacture’s instructions.
7. The boiler and system may now be filled through the fill valves.
8. If using glycol, ensure it is an approved glycol and ratio.
9. Verify water quality is within the stated values in section “4.4.1 Water Quality Guidelines.”

### ➔ IMPORTANT

- Water should be within guidelines for water quality listed in section “4.4.1 Water Quality Guidelines.”
- Use the proper water treatment to ensure the pH and water hardness are within the Rinnai boiler water quality guidelines listed in section “4.4.1 Water Quality Guidelines.”
- Test the pH of the water that will be used for filling the system.

# 14.3 Boiler Parts

## Boiler Casing

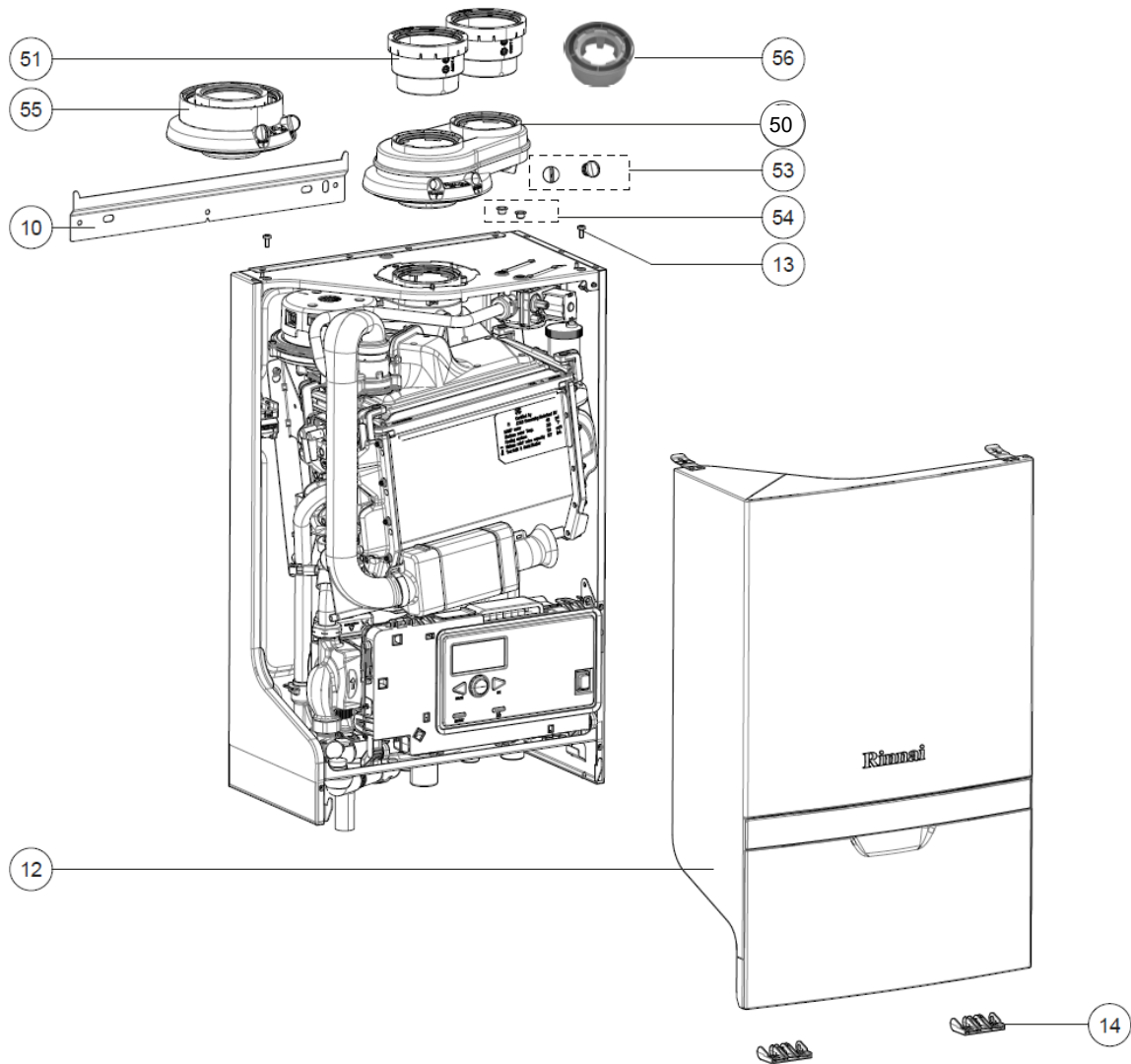

Item #	Description	Part Number	Quantity			
			M060S	M090S	M120S	M160S
10	Boiler Mounting Bracket	809000161	1	1	1	1
12	Front cover	809000145	1	1	1	1
13	Screw M5 x 12 mm	809000019	2	2	2	2
14	Hinge	809000146	2	2	2	2
50	2-pipe adapter	802000005	1	1	1	1
51	3 in. PVC adapter	802000006	2	2	2	2
53	Measurement port plug	808000024	1	1	1	1
54	Gas valve screw plug	809000148	1	1	1	1
55	3/5 in. Concentric Adapter	802000008	1	1	1	1
56	2 in. Flue Adapter	802000007	1	1	1	1



# Heat Exchanger

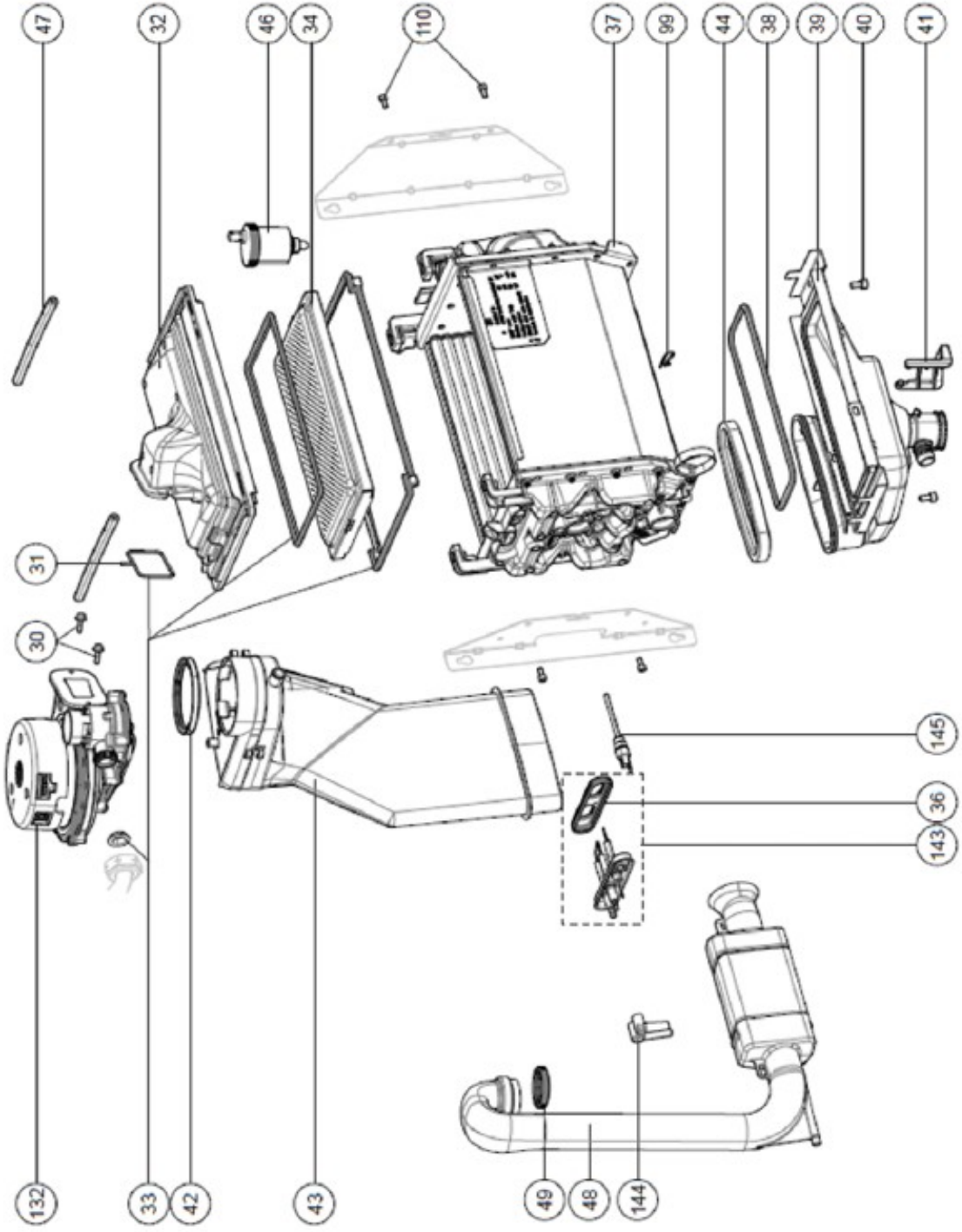



## Heat Exchanger (Continued)

Item #	Description	Part Number	Quantity			
			M060S	M090S	M120S	M160S
30	Screw M5x16	809000015	2	2	2	2
31	Gasket	808000037	1	1	1	1
32	Burner hood	806000035	1	1	-	-
		806000036	-	-	1	1
33	Gasket kit	806000037	1	1	-	-
		806000038	-	-	1	1
34	Burner	806000032	1	1	-	-
		806000033	-	-	1	1
36	Electrode gasket	805000062	1	1	1	1
37	Heat exchanger	807000169	1	1	-	-
		807000170	-	-	1	1
38	Condensate tray gasket	807000135	1	1	-	-
		807000136	-	-	1	1
39	Condensate tray	807000137	1	1	-	-
		807000138	-	-	1	1
40	Stainless Steel Screw M6x12	809000163	2	2	2	2
41	Condensate trap latch	807000139	1	1	1	1
42	Flue gasket	802000002	1	1	1	1
43	Exhaust vent box	802000003	1	1	1	1
44	Flue/condensate tray gasket	802000004	1	1	1	1
46	De-aerator	807000024	1	1	1	1
47	Clamp bar	809000147	2	2	2	2
48	Silencer	808000038	1	1	1	1
49	Silencer gasket	808000039	1	1	1	1
99	Water control assembly retention clip	807000160	6	6	6	6
110	Allen head bolt M5 x10 mm	809000150	4	4	4	4
132	Fan/venturi	808000035	1	1	-	-
		808000036	-	-	1	1
143	Ignition/Electrode assembly	805000059	1	1	1	1
144	Igniter cable	805000066	1	1	1	1
145	Supply temperature sensor	805000056	1	1	1	1

# Hydraulic Parts/Pipes

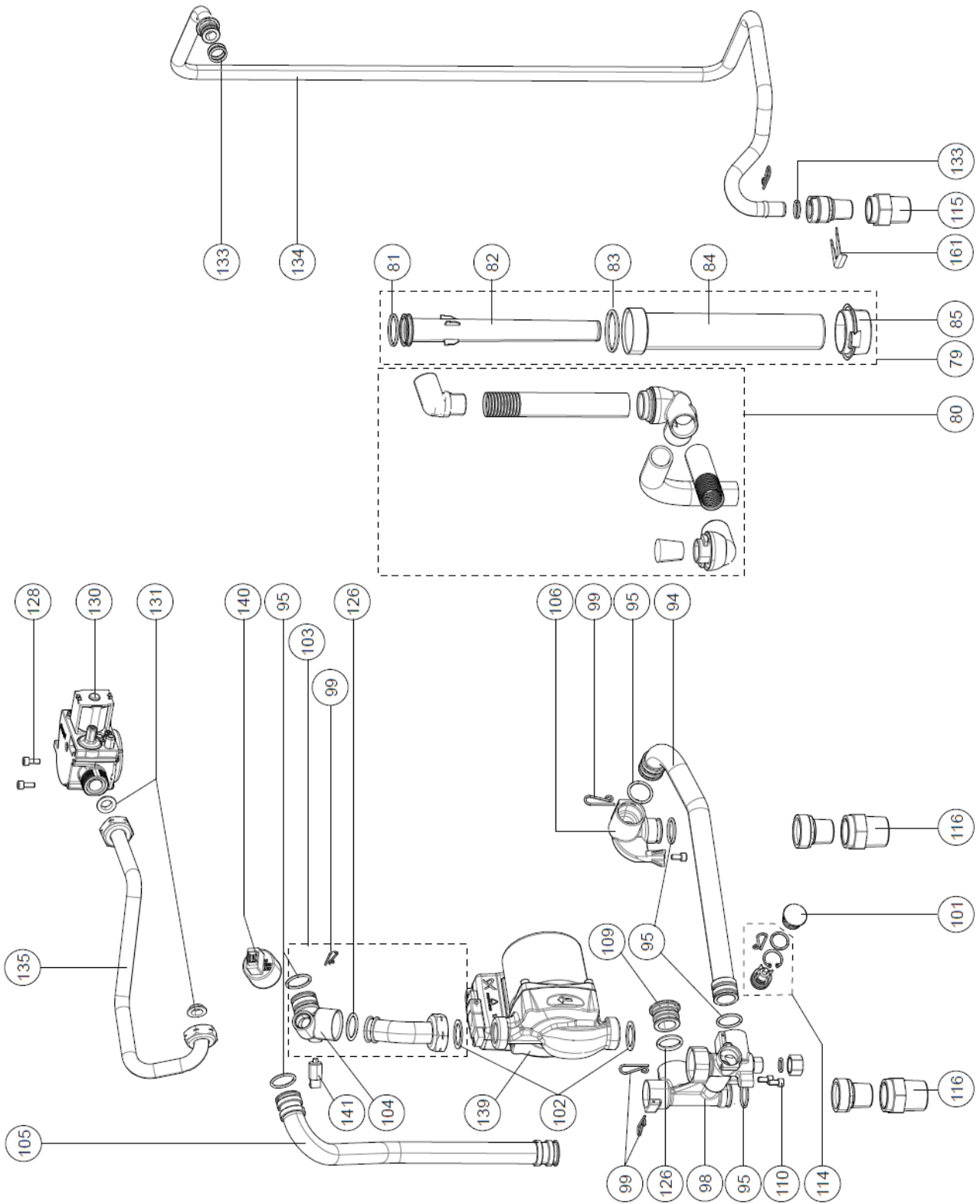

## Hydraulic Parts/Pipes (Continued)

Item #	Description	Part Number	Quantity			
			M060S	M090S	M120S	M160S
79	Condensate collector kit	807000140	1	1	1	1
80	Condensate drain kit	807000141	1	1	1	1
81	Condensate drain o-ring Ø28.25 x 2.62 mm	807000142	1	1	1	1
82	Condensate drain inner tube	807000143	1	1	1	1
83	Condensate drain tube o-ring Ø37.69 x 3.53 mm	807000144	1	1	1	1
84	Condensate drain outer tube	807000145	1	1	1	1
85	Condensate collector cover gasket	807000146	1	1	1	1
94	3-way valve/pump pipe	807000156	1	1	1	1
95	O-ring Ø21.89 x 2.62 mm	809000088	5	5	5	5
98	Hydro Group Supply	807000159	1	1	1	1
99	Water control pipe retention clip	807000160	6	6	6	6
100	Bolt M3 x 30	809000149	2	2	2	2
101	Water control assembly supply plug	807000161	1	1	1	1
102	Pump gasket 1 in.	807000099	2	2	2	2
103	Pump connection assembly	807000162	1	1	1	1
104	Pipe Return Elbow	807000163	1	1	1	1
105	Supply Pipe to Heat Exchanger	807000164	1	1	1	1
106	Water Control Assembly Return	807000165	1	1	1	1
109	Water Control Assembly Supply Cap	807000166	1	1	1	1
110	Allen head bolt M5 x10 mm	809000150	4	4	4	4
114	Bypass valve kit	807000167	1	1	1	1
115	Gas/DHW connection fitting 1/2 in. FNPT x 3/4 in. MNPT	806000041	1	1	1	1
116	Supply/return fitting 3/4 in. FNPT x 1 in. MNPT	807000168	2	2	2	2
126	O-Ring Ø21.82 x 3.53 mm	807000153	2	2	2	2
128	Screw M5x12	809000045	2	2	2	2
130	Gas valve	806000034	1	1	1	1
131	3/4 in. gas valve gasket	809000062	1	1	1	1
133	Yellow silicone o-ring Ø13.94 x 2.62 mm	809000055	1	1	1	1
134	Gas pipe to gas valve	806000047	1	1	1	1
135	Gas pipe/gas valve to fan	806000048	1	1	1	1
139	Pump	807000132	1	1	1	1
140	Water pressure sensor	805000058	1	1	1	1
141	Return temperature sensor	805000057	1	1	1	1
161	Clip Ø19 mm	809000158	1	1	1	1

# Electrical Components

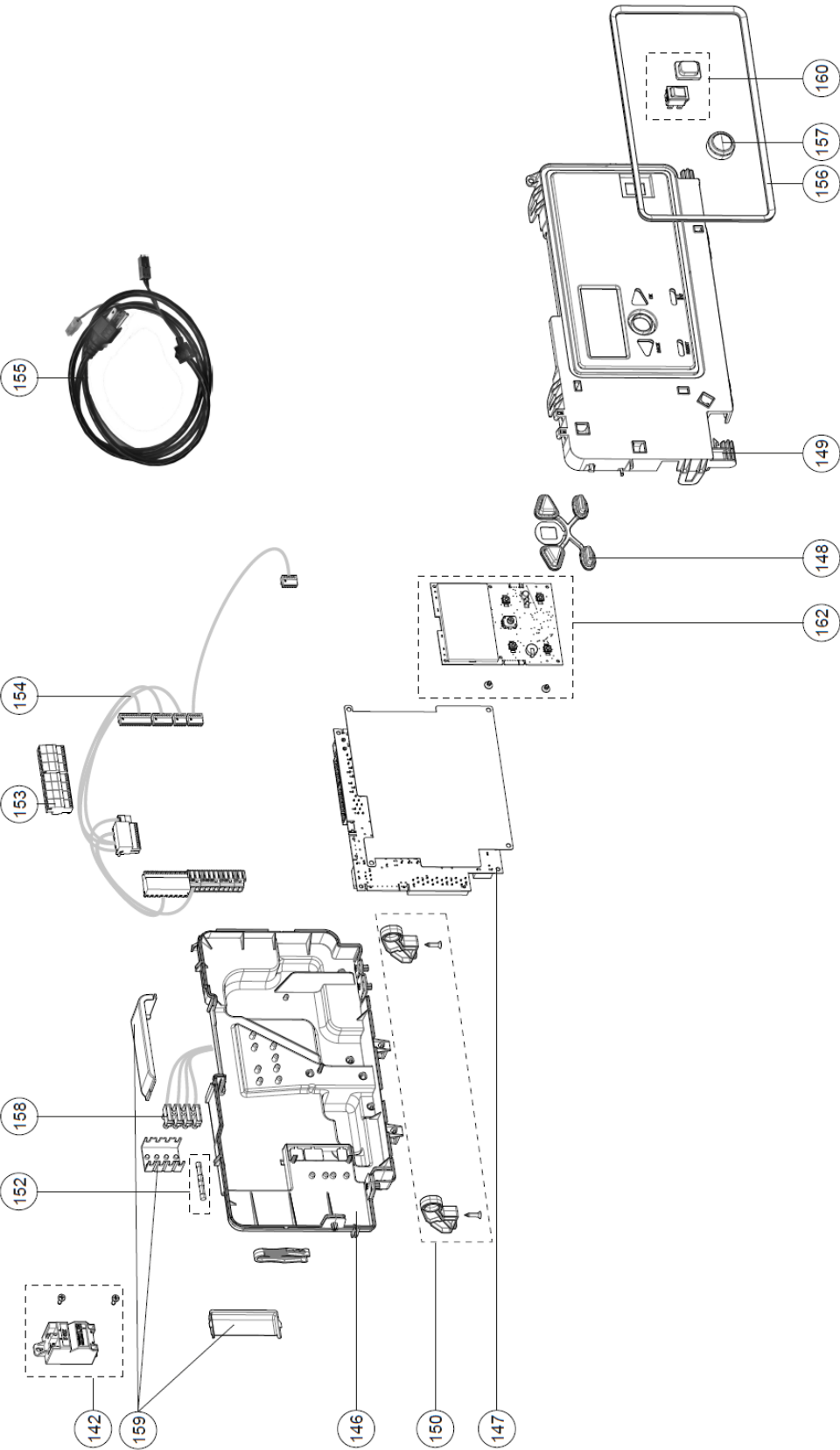

## Electrical Components (Continued)

Item #	Description	Part Number	Quantity			
			M060S	M090S	M120S	M160S
142	Ignition control box	805000060	1	1	1	1
146	controller casing/back	809000152	1	1	1	1
147	PC Board	805000055	1	1	1	1
148	Key pad	805000067	1	1	1	1
149	Controller casing/front	809000153	1	1	1	1
150	Hinge support	809000154	2	2	2	2
152	Fuse 4A (250V)	805000068	1	1	1	1
153	Screw terminal-white	805000069	1	1	1	1
	Screw terminal-blue	805000071	1	1	1	1
	Screw terminal-red	805000072	1	1	1	1
	Screw terminal-yellow	805000070	1	1	1	1
154	Wire harness	805000073	1	1	1	1
155	Power Cord	805000074	1	1	1	1
156	Controller gasket	809000155	1	1	1	1
157	Controller scroll wheel	809000156	1	1	1	1
158	Cable Harness for Ext. 3WV	805000075	1	1	1	1
159	Controller cover	809000157	1	1	1	1
160	On/off switch	805000076	1	1	1	1
162	Display for PCB	805000077	1	1	1	1

## 14.4 System Application Examples

### ▶ IMPORTANT

Primary/secondary piping is necessary in the following applications:

- When using external pumps
- Large zoned systems
- High flow applications
- Systems with high differential pressures
- Systems with high pressure drops

For pressure curve information, refer to the following sections in the Appendix.

- 14.8 CH Pressure Drop and Flow Curve
- 14.9 DHW Pressure Drop and Flow Curve

#### Legend:

Refer to the legend below for the system applications shown in this section.

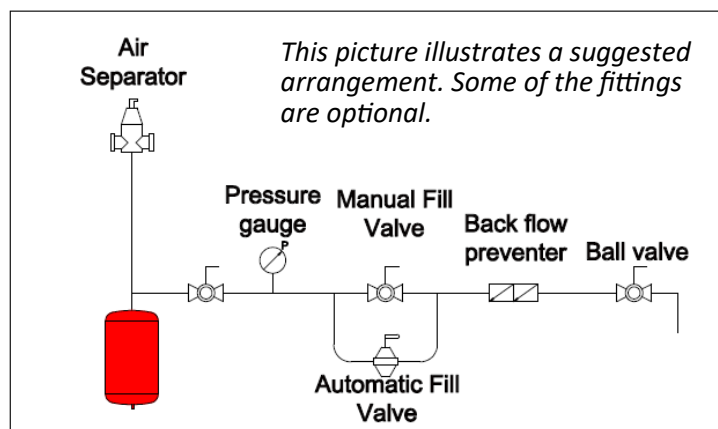
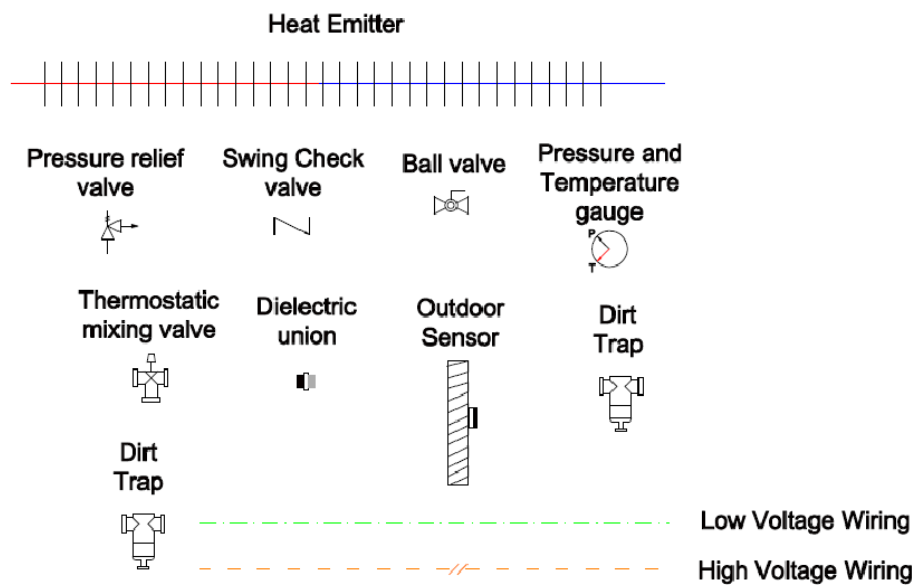

# 14.4.1 Single Zone with Hydraulic Separation Plumbing

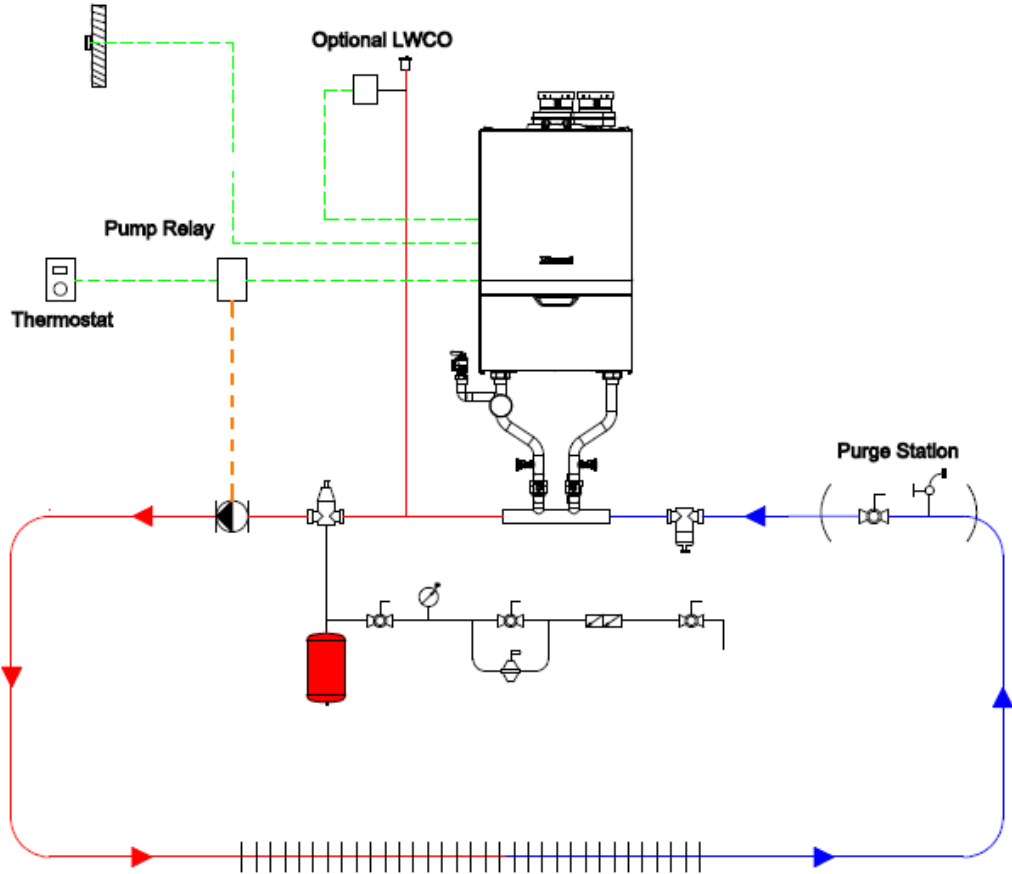

PC Board Wiring for the above application example

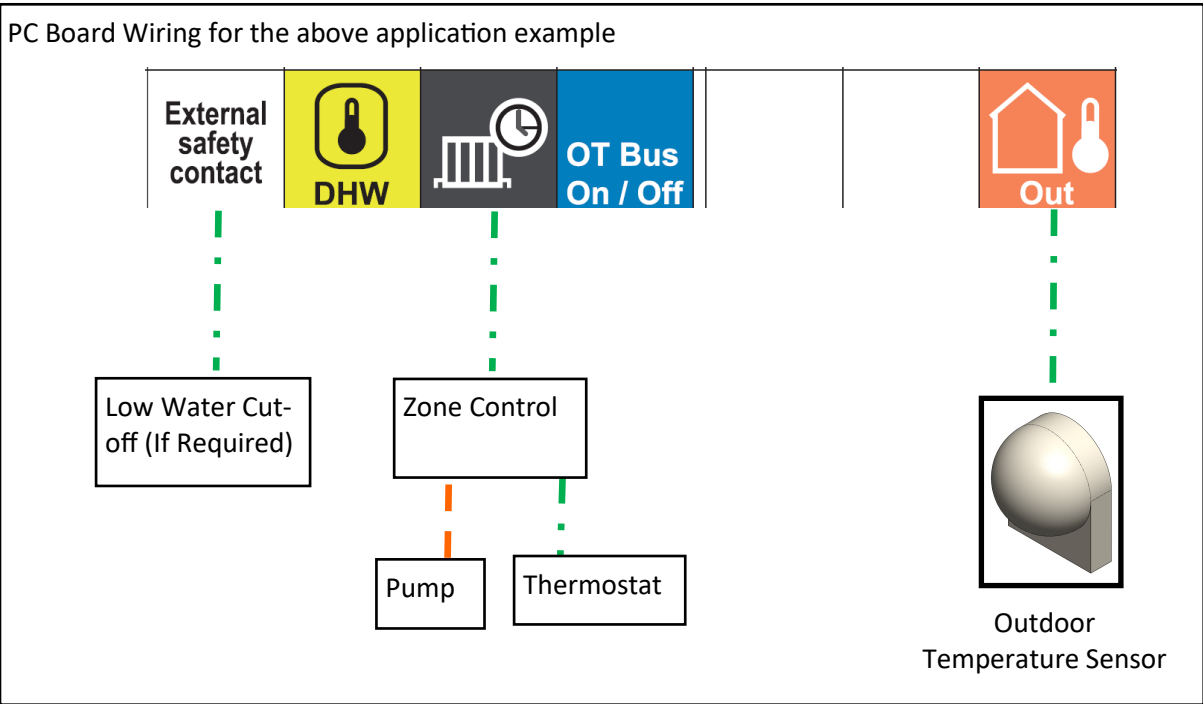

# 14.4.2 Multiple Zones with Hydraulic Separation Plumbing

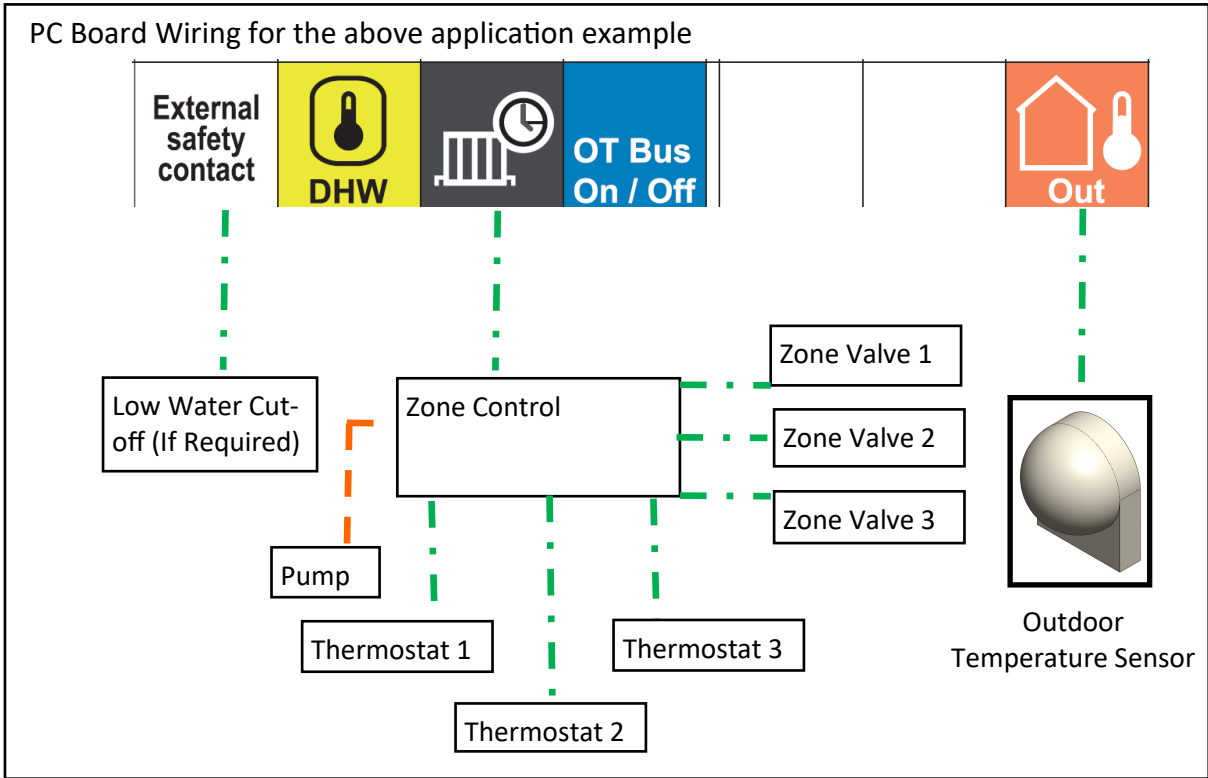
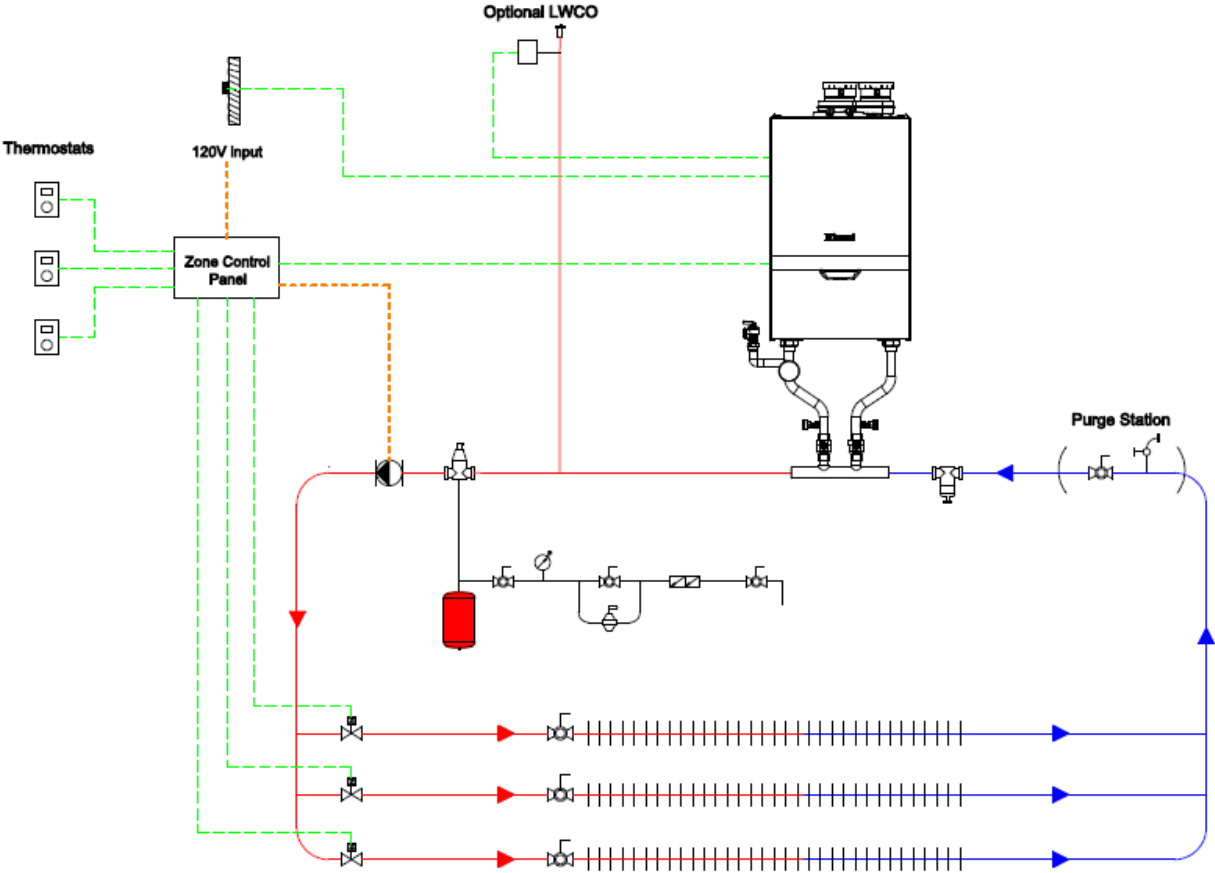



# 14.4.3 Air Handler with Hydraulic Separation Plumbing

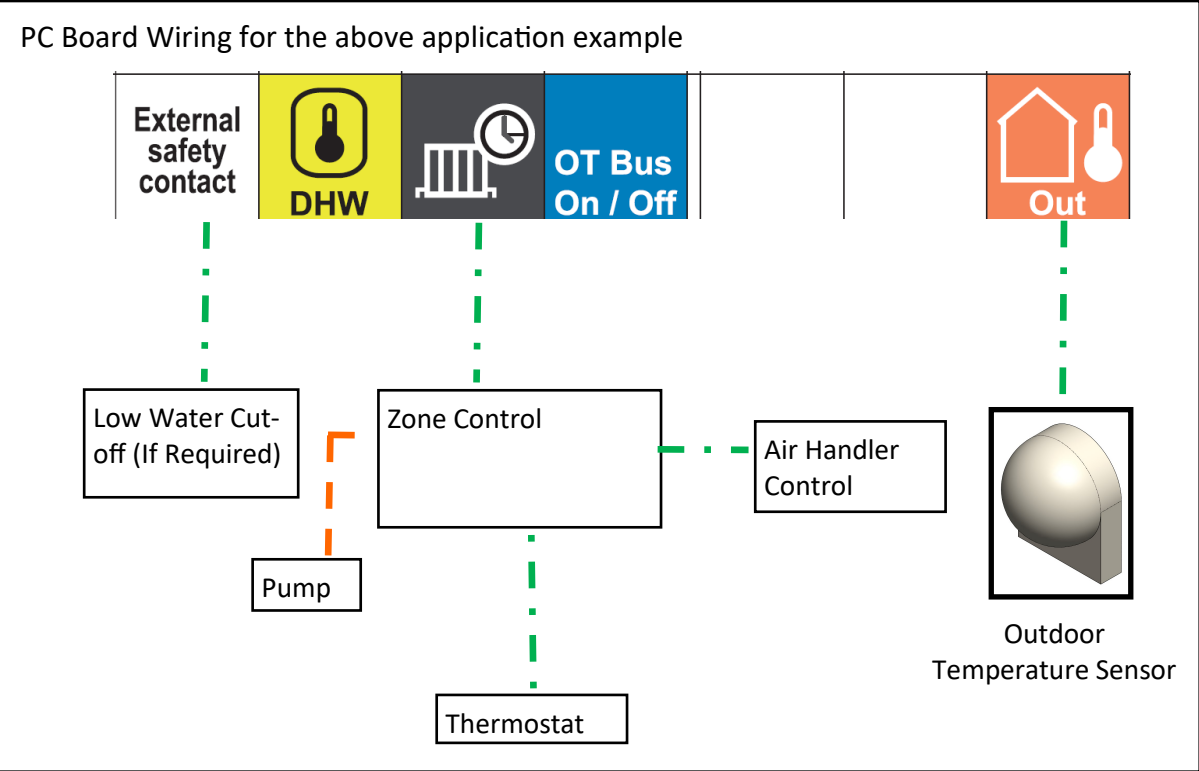
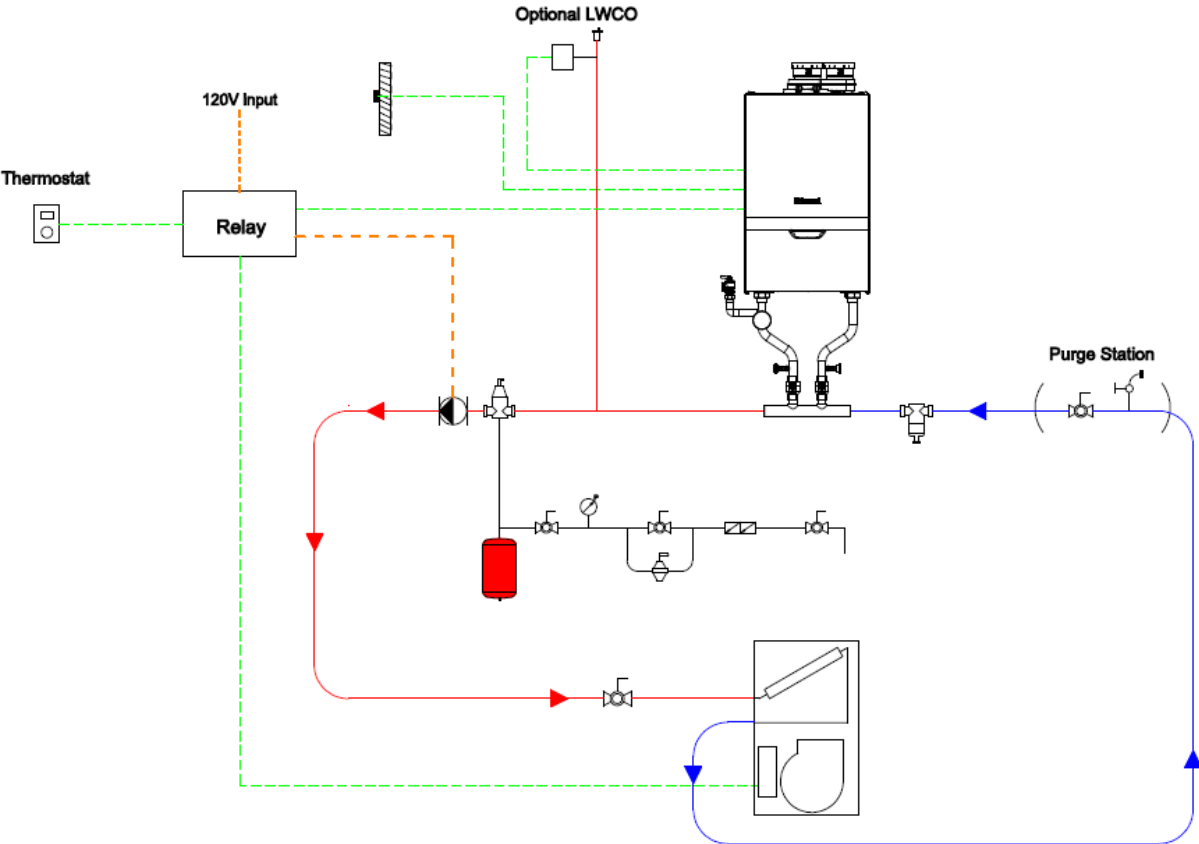

# 14.4.4 Multiple Zones (with Pump) with Hydraulic Separation Plumbing

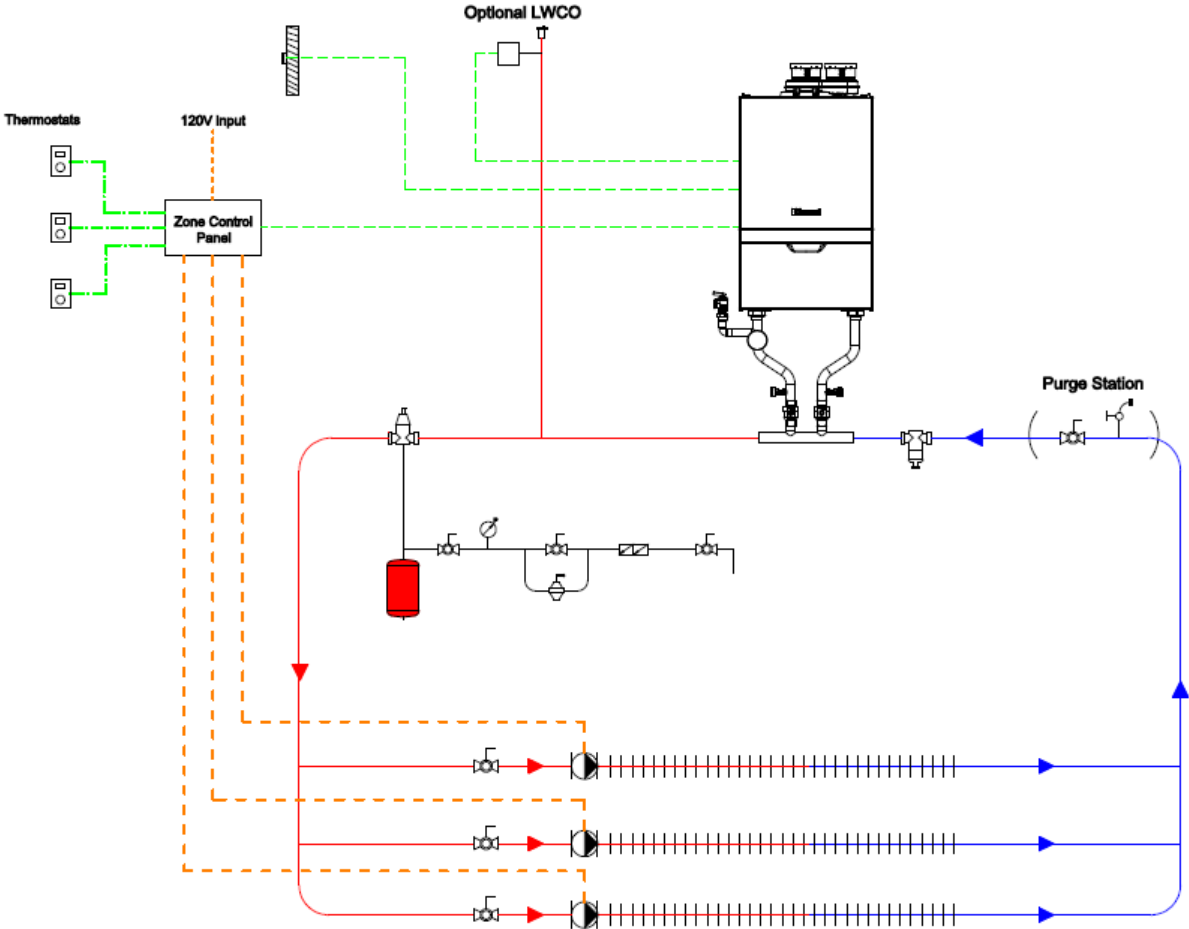

PC Board Wiring for the above application example

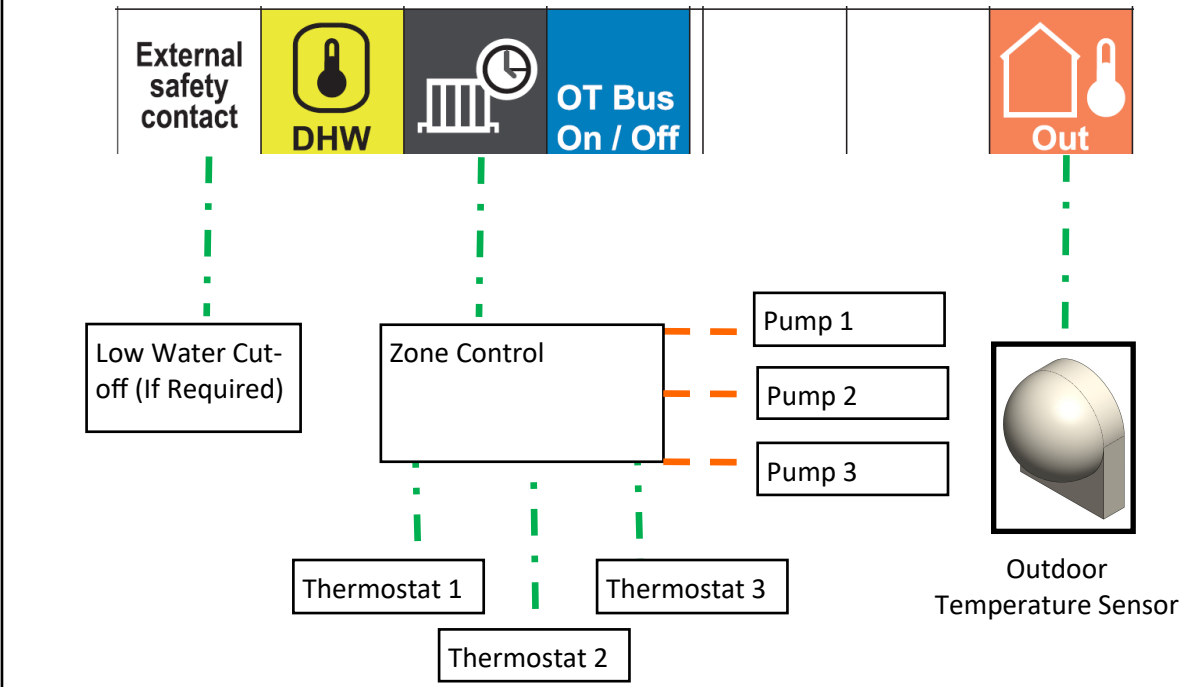

# 14.4.5 System Separation for Oxygen Permeable Piping

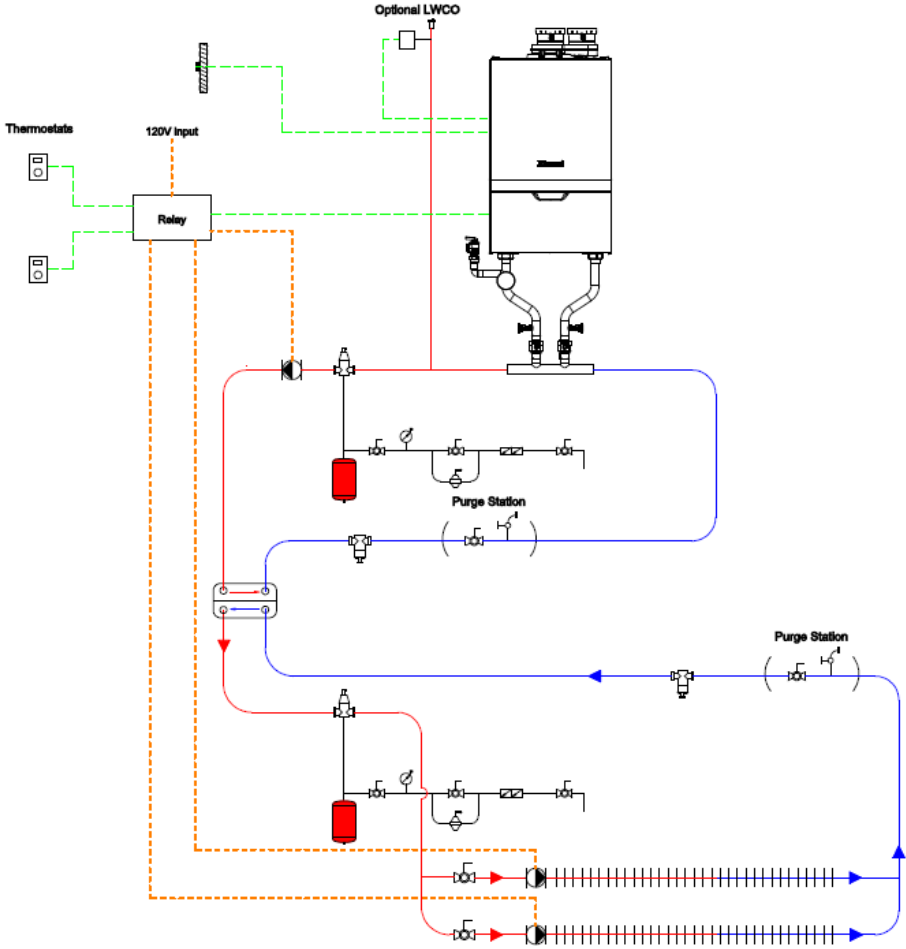

PC Board Wiring for the above application example

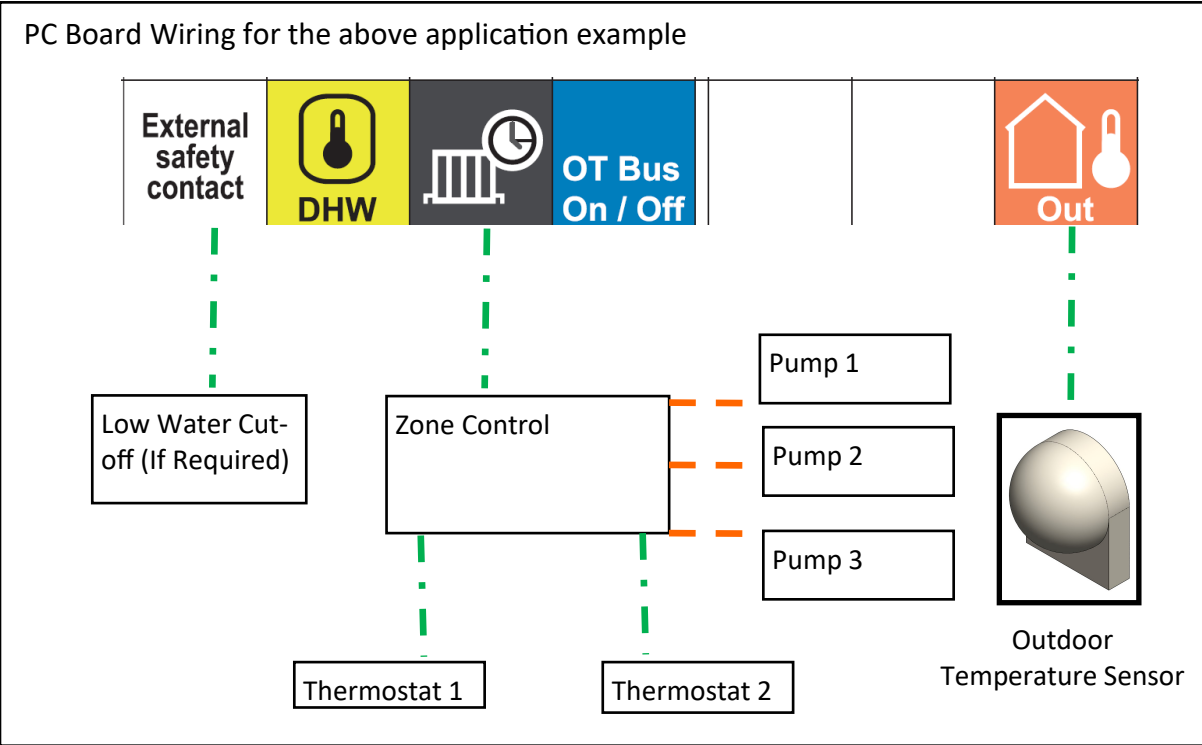

# 14.5 Gas Conversion

This boiler is configured for Natural Gas only. To convert to Propane Gas, follow the instructions in this section.

## WARNING

- The conversion kit shall be installed by a qualified service agency in accordance with the manufacturer's instructions and all applicable codes and requirements of the authority having jurisdiction. The information in these instructions must be followed exactly to minimize the risk of fire or explosion or to prevent property damage, personal injury or death. The qualified service agency is responsible for the proper installation of this kit. The installation is not proper and complete until the operation of the converted appliance is checked as specified in the manufacturer's instructions supplied with the kit.
- Failure to correctly assemble the components according to these instructions may result in a gas leak or explosion.

For installations in Canada, the conversion shall be carried out in accordance with the requirements of the provincial authorities having jurisdiction and in accordance with the requirements of the CGA-B149.1, Natural Gas and Propane Installation Code.

The appliance must be installed in accordance with:

- Local codes or, in the absence of local codes, the National Fuel Gas Code, ANSI Z223.1/NFPA 54 and/or CSA B149.1, Natural Gas and Propane Installation Code.
- The Manufactured Home Construction and Safety Standard, Title 24 CFR, Part 3280 and/or CAN/CSA Z240 MH Series, Mobile Homes, Series M86 / *Manufactured Home Construction and Safety Standard, Title 24 CFR.*

## CAUTION

The gas supply shall be shut off prior to disconnecting the electrical power, before proceeding with the conversion.

## CAUTION

Do not touch any other areas on the PC board other than the described buttons while power is supplied to the appliance. Parts of the PC board are supplied with 120 volts AC.

## CAUTION

Do not touch the areas at or near the heat exchanger or hot water lines. These areas become very hot and could cause burns.

## IMPORTANT

- Before you get started, confirm that the inlet gas pressure is between the minimum and maximum pressures allowed for this boiler.
- If subsequent conversions are made, then a new conversion label must be placed on the boiler to accurately reflect the gas type.

## 14.5.1 Items Required

- Conversion Kit (supplied with boiler)
- Adjustable wrench
- Combustion analyzer

1. Confirm that the inlet gas pressure is between the minimum and maximum pressures allowed for this boiler.
2. Disconnect electrical power to the boiler.
3. Turn off the boiler's gas supply by turning off the gas control valve.
4. Remove the boiler's front panel. For details, see sections "3.7 How to Remove the Front Panel".
5. Remove the air supply damper:
  - Unclip the Velcro piece
  - Lift up the air supply damper to remove and gently place aside

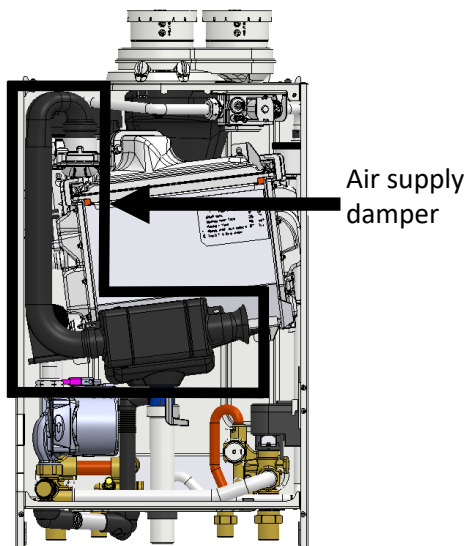

7. Remove the gas line and place aside.

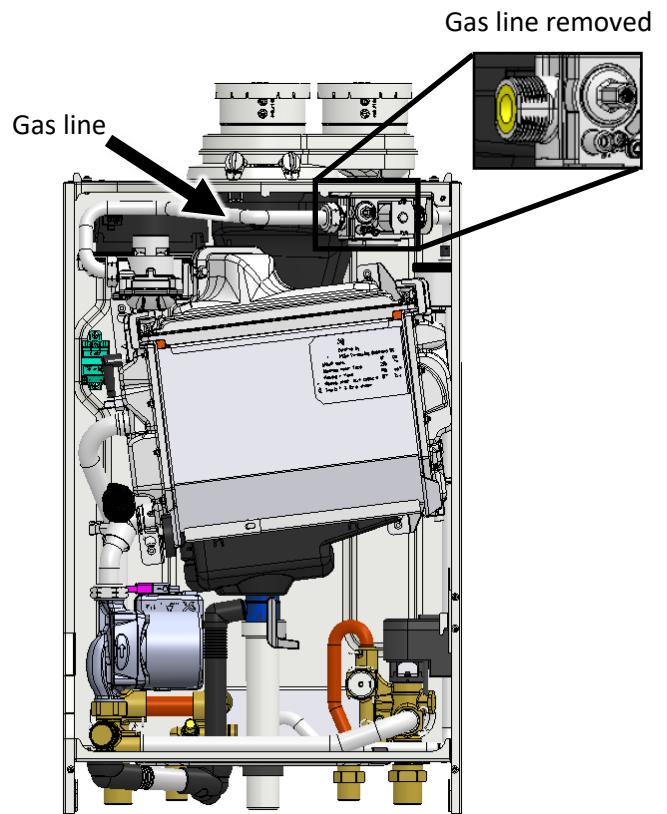

8. Pull out the yellow gasket from the gas venturi.

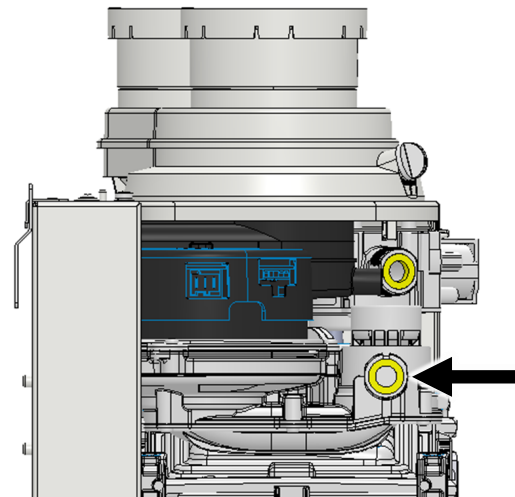

6. Unscrew the gas valve and gas venturi connections.

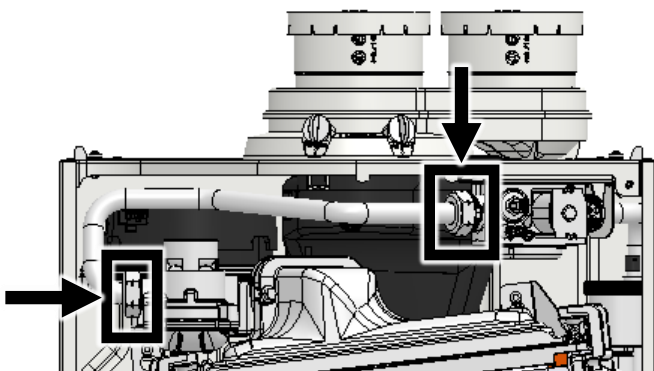

- Remove the Liquid Propane restrictor in the gas venturi.

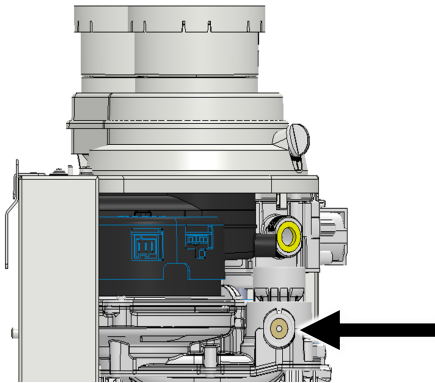

- Replace the yellow gasket into the gas venturi.

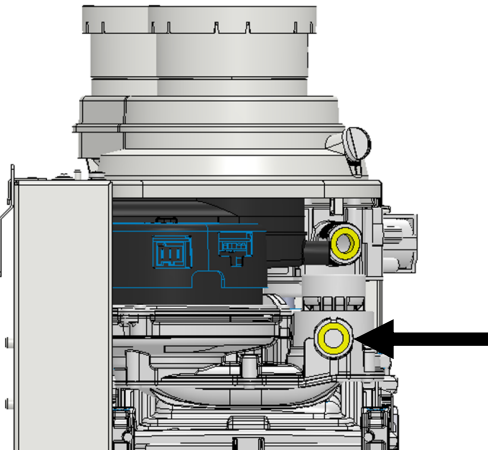

- Reconnect the gas valve, gas venturi connections and gas line.
- Reconnect the air supply damper.
- Locate the controller. Remove all screw terminals and unclip the 6 tabs from the front panel.

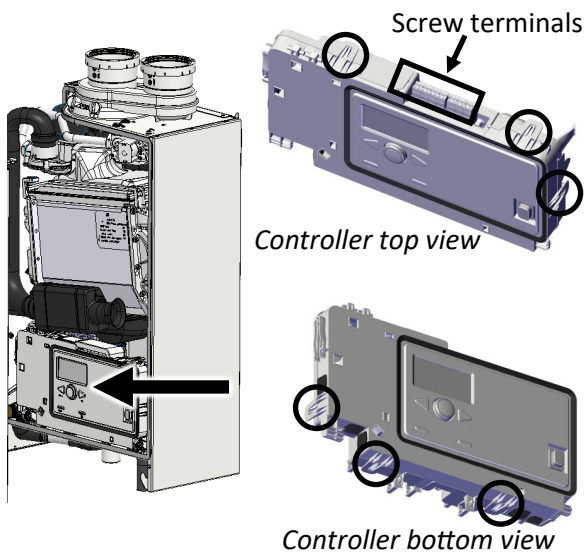

- Remove the front housing of the PC Board.

- Insert the EEPROM key (included with conversion kit) into the connector on the PC Board.

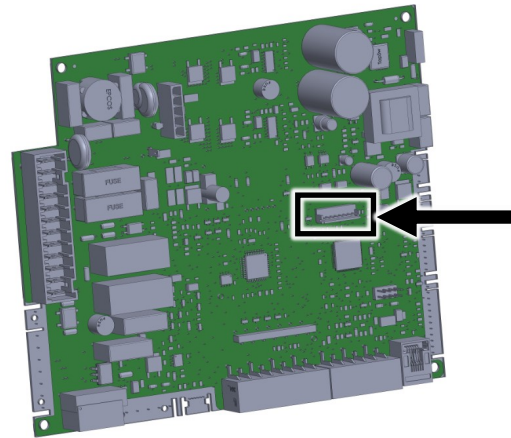

- Reattach the PC Board front housing and screw terminals.
- Connect electrical power and power up the boiler.
- The **Airpurge active** screen appears on the boiler display.

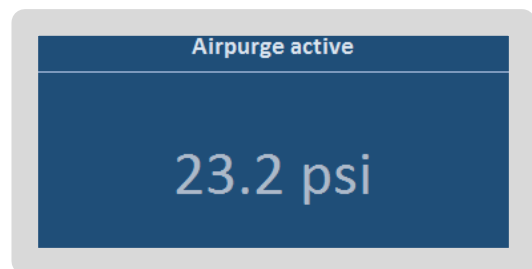

*Your psi values may differ than the values shown in image.*

- Press the **Back** button for approximately 7 seconds.

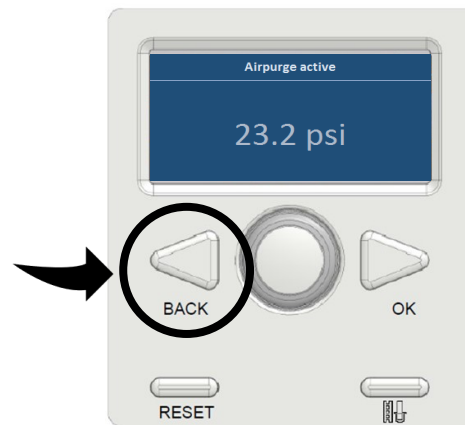

20. The **Flash Memory Detected** screen appears. Select **COPY** and Press **OK**.

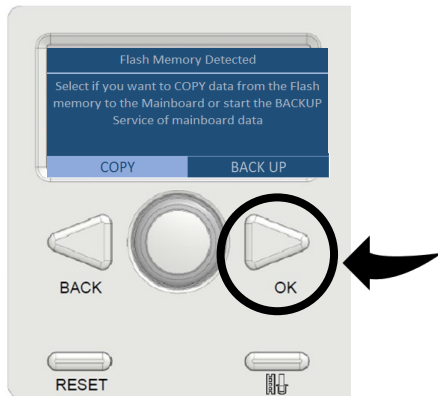

21. The following screen appears indicating data parameters have been copied to the Mainboard.

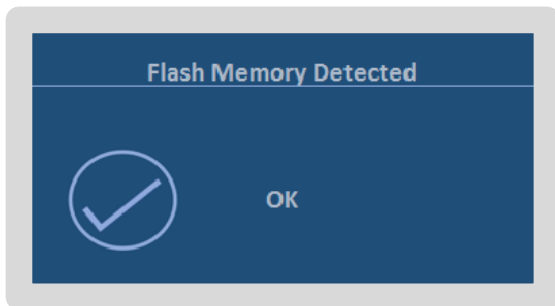

22. The Home screen briefly appears on the display and then the boiler turns off.

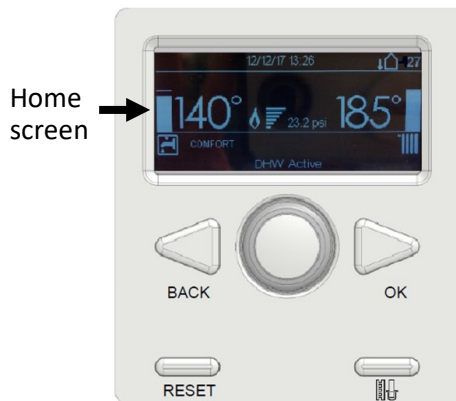

23. After a few seconds, the boiler automatically turns on and goes into **Airpurge active** mode.

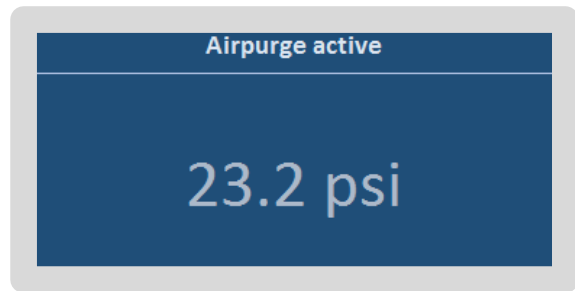

*Your psi values may differ than the values shown in image.*

24. To remove the EEPROM key from the PC Board:

- Disconnect power to the boiler
- Remove the front housing of the PC Board.
- Remove the EEPROM key from the connector.

25. Reattach the PC Board front housing and screw terminals. Clip the 6 tabs back into place.

26. Connect electrical power to the boiler. The boiler will be back in normal operating mode with the proper gas type parameters.

27. Replace the boiler front panel.

28. The conversion process is complete. Verify the O<sub>2</sub> settings in minimum and maximum input for your new gas type. See section "10 Commissioning" for detailed instructions.

29. Verify flame appearance as shown below with the boiler in operation.

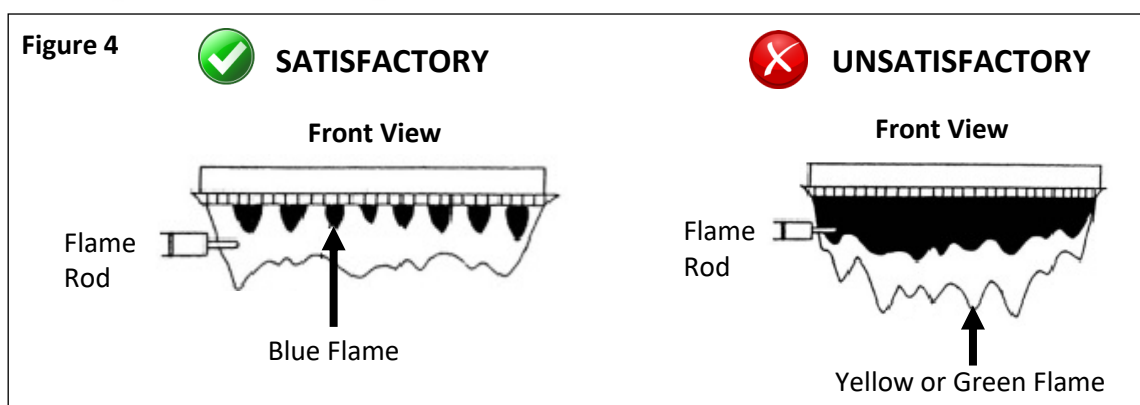

# 14.6 Wiring Diagram

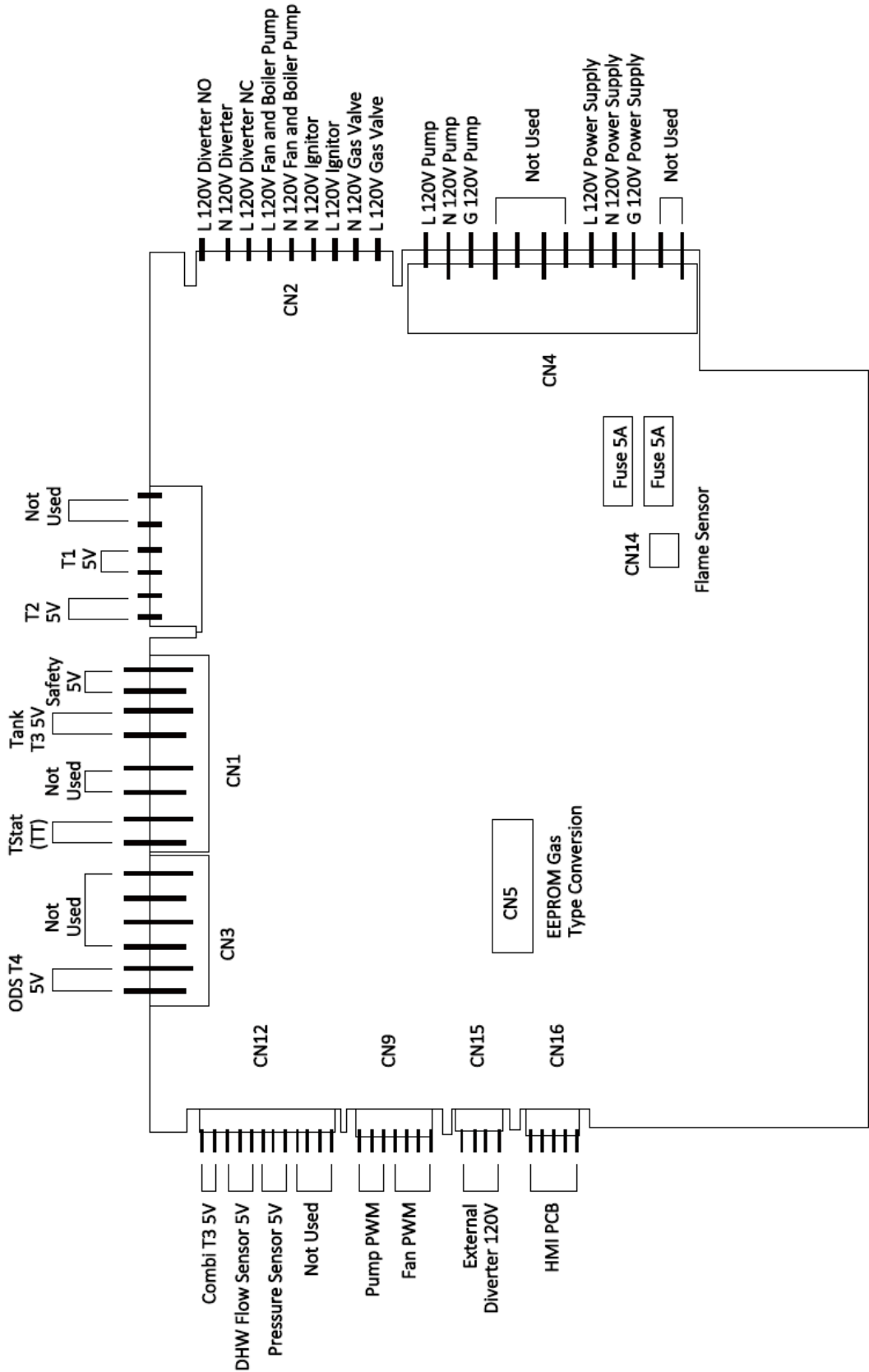

NOTE: All 5V terminals are direct current.



# 14.7 Ladder Diagram

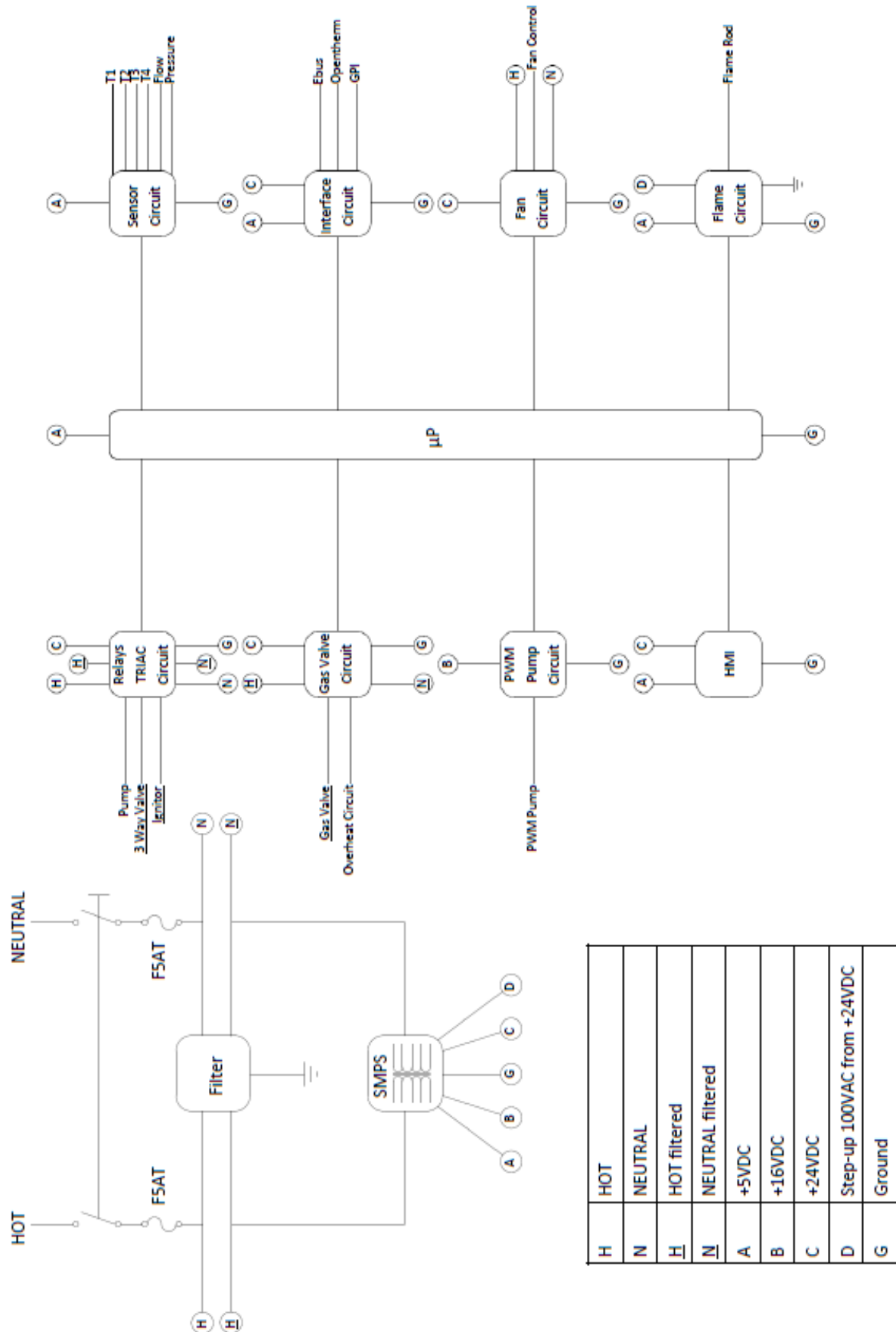

# 14.8 CH Pressure Drop and Flow Curve

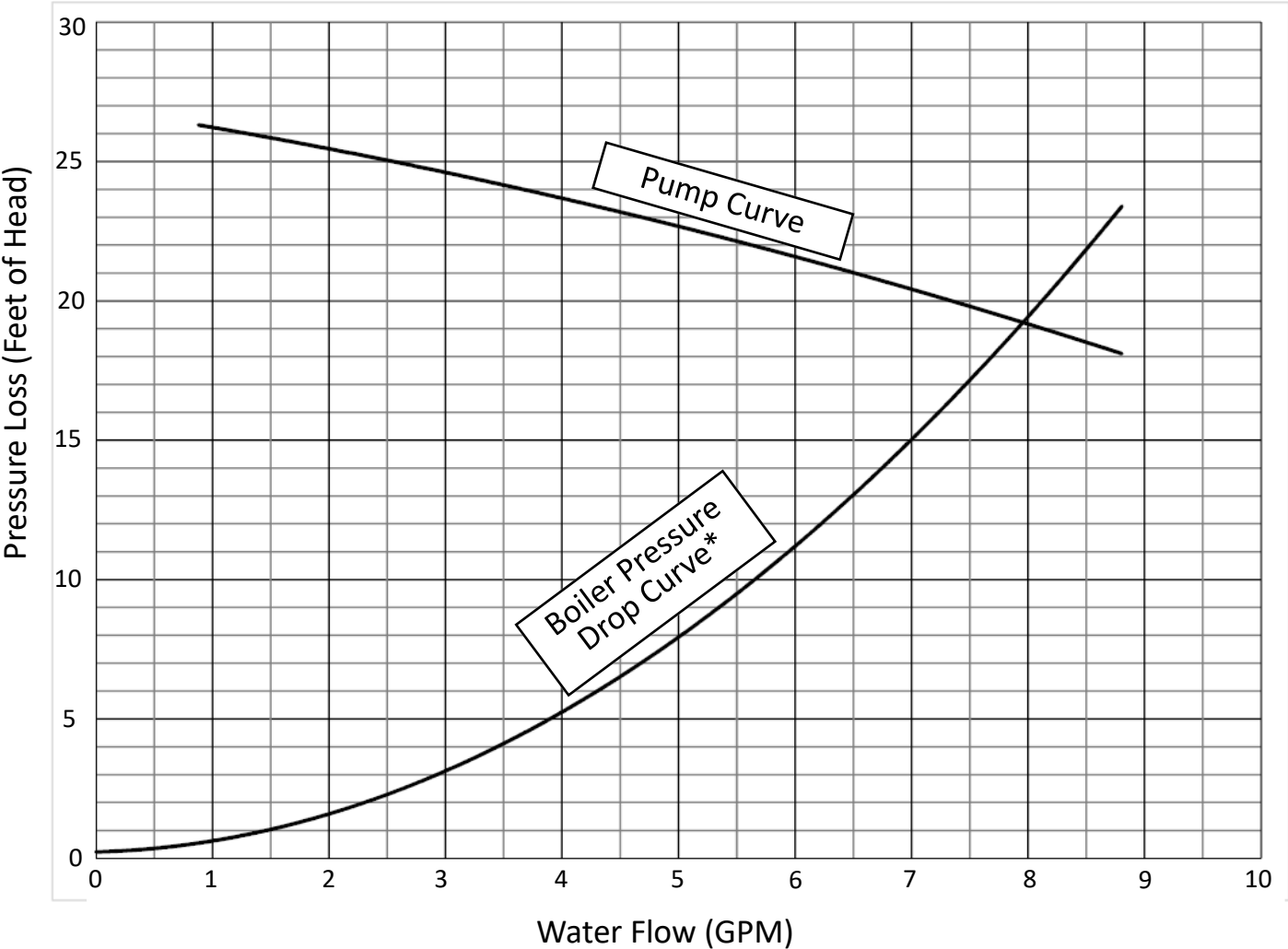

\* Pressure drop curve applies to all M-Series Condensing Boilers (M060C, M090C, M120C and M160C).

## 14.9 Resistance/Temperature Table for Sensors

Outdoor Reset Sensor (T4)			Supply Sensor (T1) Return Sensor (T2) DHW Sensor (T3)		
NTC1k (25°C)			NTC10k (25°C)		
Temperature (°C)	Temperature (°F)	Resistance (Ω)	Temperature (°C)	Temperature (°F)	Resistance (Ω)
-10	14.0	4.574	-10	14.0	55.047
-9	15.8	4.358	0	32.0	32.555
-8	17.6	4.152	10	50.0	19.873
-7	19.4	3.958	12	53.6	18.069
-6	21.2	3.774	14	57.2	16.447
-5	23.0	3.600	16	60.8	14.988
-4	24.8	3.435	18	64.4	13.674
-3	26.6	3.279	20	68.0	12.488
-2	28.4	3.131	22	71.6	11.417
-1	30.2	2.990	24	75.2	10.449
0	32.0	2.857	26	78.8	9.573
1	33.8	2.730	28	82.4	8.779
2	35.6	2.610	30	86.0	8.059
3	37.4	2.496	32	89.6	7.406
4	39.2	2.387	34	93.2	6.811
5	41.0	2.284	36	96.8	6.271
6	42.8	2.186	38	100.4	5.779
7	44.6	2.093	40	104.0	5.330
8	46.4	2.004	42	107.6	4.921
9	48.2	1.920	44	111.2	4.547
10	50.0	1.840	46	114.8	4.205
11	51.8	1.763	48	118.4	3.892
12	53.6	1.690	50	122.0	3.605
13	55.4	1.621	52	125.6	3.343
14	57.2	1.555	54	129.2	3.102
15	59.0	1.492	56	132.8	2.880
16	60.8	1.433	58	136.4	2.677
17	62.6	1.375	60	140.0	2.490
18	64.4	1.320	62	143.6	2.318
19	66.2	1.268	64	147.2	2.159
20	68.0	1.218	66	150.8	2.013
21	69.8	1.170	68	154.4	1.878
22	71.6	1.125	70	158.0	1.753
23	73.4	1.081	72	161.6	1.638
24	75.2	1.040	74	165.2	1.531
25	77.0	1.000	76	168.8	1.433
26	78.8	0.962	78	172.4	1.341
27	80.6	0.926	80	176.0	1.256
28	82.4	0.892	82	179.6	1.178
29	84.2	0.858	84	183.2	1.105
30	86.0	0.827	86	186.8	1.037
35	95.0	0.687	88	190.4	0.974
40	104.0	0.575	90	194.0	0.915

# 14.10 Remove a Boiler from a Common Vent System

## (As Required by ANSI Z21.13)

The following information is required by ANSI Z21.13:

If a boiler is removed from a common vent system, the common vent system is likely to be too large for proper venting of the remaining appliances connected to it.

The instructions shall include the test procedure set forth below:

At the time of removal of an existing boiler, the following steps shall be followed with each other appliances remaining connected to the common venting system are not in operation.

1. Seal any unused openings in the common venting system.
2. Visually inspect the venting system for proper size and horizontal pitch and determine there is no blockage or restriction, leakage, corrosion and other deficiencies which could cause an unsafe condition.
3. Insofar as is practical, close all building doors and windows and all doors between the space in which the appliances remaining connected to the common venting system are located and other spaces of the building. Turn on clothes dryers and any appliance not connected to the common venting system. Turn on any exhaust fans, such as range hoods and bathroom exhausts, so they will operate at maximum speed. Do not operate a summer exhaust fan. Close fireplace dampers.
4. Place in operation the appliance being inspected. Follow the lighting instructions. Adjust thermostat so appliance will operate continuously.
5. Test for spillage at the draft hood relief opening after five minutes of main burner operation. Use the flame of a match or candle, or smoke from a cigarette, cigar, or pipe.
6. After it has been determined that each appliance remaining connected to the common venting system properly vents when tested as outlined above, return doors, windows, exhaust fans, fireplace dampers, and any other gas-burning appliance to their previous condition of use.
7. Any improper operation of the common venting system should be corrected so the installation conforms with the National Fuel Gas Code, ANSI Z223.1/NFPA 54, and/or the Natural Gas and Propane Installation Code, CAN/CSA B149.1. When resizing any portion of the common venting system, the common venting system should be resized to approach the minimum size as determined using the appropriate tables in Chapter 13 of the National Fuel Gas Code, ANSI Z223.1/NFPA 54, and/or the Natural Gas and Propane Installation Code, CAN/CSA B149.1.

# 14.11 Massachusetts State Gas Regulations

## FOR GAS MODELS SOLD IN MASSACHUSETTS

### NOTICE BEFORE INSTALLATION:

This direct-vent appliance must be installed by a properly trained licensed professional. If you are not properly trained, you must not install this unit.

### IMPORTANT: In the State of Massachusetts (248 CMR 4.00 & 5.00):

For all side wall horizontally vented gas fueled equipment installed in every dwelling, building or structure used in whole or in part for residential purposes, including those owned or operated by the Commonwealth and where the side wall exhaust vent termination is less than 7 ft above finished grade in the area of the venting, including but not limited to decks and porches, the following requirements shall be satisfied:

1. **INSTALLATION OF CARBON MONOXIDE DETECTORS.** At the time of installation of the side wall horizontal vented gas fueled equipment, the installing plumber or gasfitter shall observe that a hard wired carbon monoxide detector with an alarm and battery back-up is installed on the floor level where the gas equipment is to be installed. In addition, the installing plumber or gasfitter shall observe that a battery operated or hard wired carbon monoxide detector with an alarm is installed on each additional level of the dwelling, building or structure served by the side wall horizontal vented gas fueled equipment. It shall be the responsibility of the property owner to secure the services of qualified licensed professionals for the installation of hard wired carbon monoxide detectors
  - A. In the event that the side wall horizontally vented gas fueled equipment is installed in a crawl space or an attic, the hard wired carbon monoxide detector with alarm and battery back-up may be installed on the next adjacent floor level.
  - B. In the event that the requirements of this subdivision can not be met at the time of completion of installation, the owner shall have a period of thirty (30) days to comply with the above requirements; provided, however, that during said thirty (30) day period, a battery operated carbon monoxide detector with an alarm shall be installed.
2. **APPROVED CARBON MONOXIDE DETECTORS.** Each carbon monoxide detector as required in accordance with the above provisions shall comply with NFPA 720 and be ANSI/UL 2034 listed and IAS certified.
3. **SIGNAGE.** A metal or plastic identification plate shall be permanently mounted to the exterior of the building at a minimum height of 8 ft above grade directly in line with the exhaust vent terminal for the horizontally vented gas fueled heating appliance or equipment. The sign shall read, in print size no less than one-half (1/2) inch in size, **"GAS VENT DIRECTLY BELOW. KEEP CLEAR OF ALL OBSTRUCTIONS."**
4. **INSPECTION.** The state or local gas inspector of the side wall horizontally vented gas fueled equipment shall not approve the installation unless, upon inspection, the inspector observes carbon monoxide detectors and signage installed in accordance with the provisions of 248 CMR 5.08(2)(a)1 through 4.

## 14.12 Warranty

### Limited Warranty for M-Series Boiler Models

#### Boiler Models:

- Combi: M060C, M090C, M120C, M160C
- Solo: M060S, M090S, M120S, M160S

#### What Is Covered?

The Rinnai Standard Limited Warranty covers any defects in materials or workmanship when the product is installed and operated according to Rinnai written installation instructions, subject to the terms within this Limited Warranty document. This Limited Warranty applies only to products that are installed correctly in the United States and Canada. Improper installation may void this Limited Warranty. It is recommended that a trained and qualified professional who has attended a Rinnai installation training class complete your installation. This Limited Warranty is subject to the conditions that the Rinnai boiler has been installed and proper maintenance has been performed, according to the Installation and Servicing Instructions, by a professional heating contractor. Proof of the required service and maintenance must be kept in the provided Rinnai Installation, Commissioning and Service Record. This Limited Warranty coverage, as set out in the table below, extends to the original purchaser and subsequent owners, but only while the product remains at the site of the original installation, and terminates if the product is moved or reinstalled at a new location.

Item	Residential Applications	Commercial Applications
Heat Exchanger	12 Years	5 Years
All Other Parts and Components*	2 Years	2 Years
Reasonable Labor	1 Year	1 Year

\* Parts replaced during recommended maintenance procedures are not covered by this Limited Warranty.

#### What Will Rinnai Do?

Rinnai will repair or replace the covered product or any part or component that is defective in materials or workmanship as set forth in the above table. Rinnai will pay reasonable labor charges associated with the repair or replacement of any such part or component during the term of the labor warranty period. All repair parts must be genuine Rinnai parts. All repairs or replacements must be performed by a qualified professional who is properly trained to do the type of repair.

Replacement of the product may only be authorized by Rinnai at its sole discretion. Rinnai does not authorize any person or company to assume for it any obligation or liability in connection with the replacement of the product. If Rinnai determines that repair of a product is not possible, Rinnai may replace the product with a comparable product at Rinnai's sole discretion. The warranty claim for product parts and labor may be denied if a component or product returned to Rinnai is found to be free of defects in material or workmanship; damaged by improper installation, use or operation; or damaged during return shipping.

**How Do I Get Service?** For the name of a trained and qualified professional, please contact your place of purchase, visit the Rinnai website ([www.rinnai.us](http://www.rinnai.us)), call Rinnai at 1-800-621-9419 or write to Rinnai at 103 International Drive, Peachtree City, Georgia 30269.

Proof of purchase is required to obtain warranty service. You may show proof of purchase with a dated sales receipt, or by registering within 90 days of purchasing the product. To register your Rinnai Condensing Boiler, please visit [www.rinnai.us](http://www.rinnai.us). For those without internet access, please call 1-800-621-9419. Receipt of registration by Rinnai will constitute proof-of-purchase for this product. Registration of product installed in new home construction may be verified with a copy of the closing papers provided by the initial home buyer. However, registration is not necessary in order to validate this Limited Warranty.

**What Is Not Covered?** This Limited Warranty does not cover any failures, heat exchanger leakage, or operating difficulties due to the following:

- Accident, abuse or misuse
- Alteration
- Misapplication
- Force majeure
- Improper installation (such as but not limited to inadequate water quality, condensate damage, improper venting, incorrect gas type, incorrect gas or water pressure, or absence of a drain pan under the product)
- Improper maintenance (such as but not limited to scale build-up, freeze damage, or vent blockage)
- Improper water quality or the use of unapproved antifreeze or other chemical additives in the boiler system
- Installation of the boiler in a heating system where polybutylene pipe without an oxygen barrier is used
- Any installation that is not closed loop or where oxygen may enter the heating system
- Use in or around areas where chemical agents are used (such as but not limited to chlorine, hair spray, or hair dyes)
- Damage or failure caused by contaminated air, including, but not limited to sheetrock particles, plasterboard particles, dust, dirt, or lint entering the boiler or any of its components
- Incorrect sizing
- A failure of any component in the Hydronic system not supplied by Rinnai
- Any other causes other than defects in materials or workmanship

This Limited Warranty does not cover any product used in an application that uses chemically treated water such as a pool or spa heater.

If you purchase a Rinnai product from an unauthorized dealer, or if the original factory serial number has been removed, defaced or altered, your Rinnai warranty will not be valid.

#### **Limitation on Warranties**

No one is authorized to make any other warranties on behalf of Rinnai America Corporation. Except as expressly provided herein, there are no other warranties, expressed or implied, including, but not limited to warranties of merchantability or fitness for a particular purpose, which extend beyond the description of the warranty herein.

Any implied warranties of merchantability and fitness arising under state law are limited in duration to the period of coverage provided by this Limited Warranty, unless the period provided by state law is less. Some states do not allow limitations on how long an implied Limited Warranty lasts, so the above limitation may not apply to you.

Rinnai shall not be liable for indirect, incidental, special, consequential or other similar damages that may arise, including lost profits, damage to person or property, loss of use, inconvenience, or liability arising from improper installation, service or use. Some states do not allow the exclusion or limitation of incidental or consequential damages, so the above limitation may not apply to you.

This Limited Warranty gives you specific legal rights, and you may also have other rights which vary from state to state.

[www.rinnai.us/warranty](http://www.rinnai.us/warranty)

# Notes

---



# Notes

---



Learn more about Rinnai high-performance Tankless Boilers, Hybrid Water Heating Systems, Boilers, Vent-Free Fan Convectors and EnergySaver® Direct Vent Wall Furnaces at:

[rinnai.us](http://rinnai.us) | [rinnai.ca](http://rinnai.ca)

# Rinnai®

Rinnai America Corporation • 103 International Drive, Peachtree City, GA 30269  
1-800-621-9419 • [rinnai.us](http://rinnai.us)

©2019 Rinnai America Corporation. Rinnai America Corporation continually updates materials, and as such, content is subject to change without notice.  
Local, state, provincial, federal and national fuel gas codes must be adhered to prior to and upon installation.

80000065(04)  
10/2019