

INSTRUCTIONS FOR MODELS

S-2500

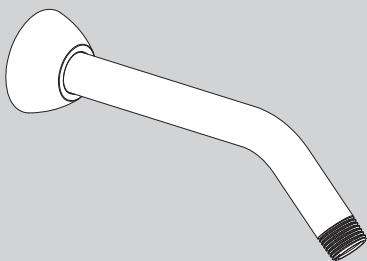

TOOLS AND SUPPLIES

Thread Seal
Tape



IMPORTANT



Be sure to read instructions thoroughly before beginning installation. Do not overtighten any connections or damage may occur.

SAFETY TIPS

Cover your drain to prevent loss of parts.

MAINTENANCE

Your new Shower Arm is designed for years of trouble-free performance. Keep it looking new by cleaning it periodically with a soft cloth. Avoid abrasive cleaners, steel wool and harsh chemicals as these will dull the finish and void your warranty.

WARRANTY

Additional warranty information can be found at:
www.speakman.com

- 1 Place the Escutcheon Plate (1) on a flat surface. Push the long end of the Shower Arm (2) down into the plate. This will help the teeth of the plate slide over the arm easier.

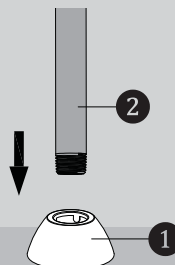

- 4 Position Escutcheon Plate (1) flat against wall.

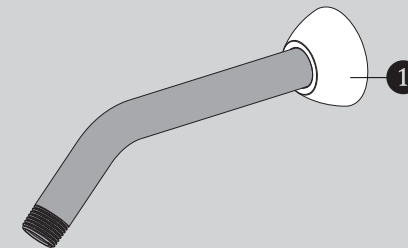

- 2 Once the Escutcheon Plate (1) is on the shower arm, slide the plate over the Shower Arm (2).

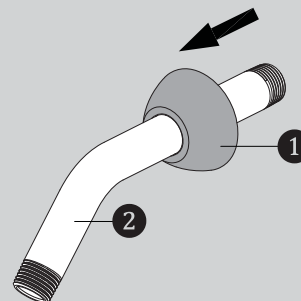

- 3 Apply Teflon Tape to inlet side of Shower Arm (2). Thread Shower Arm (2) into Female Pipe Fitting within the wall. Firmly tighten, and make sure Shower Arm (2) Outlet is pointing in a downward position.

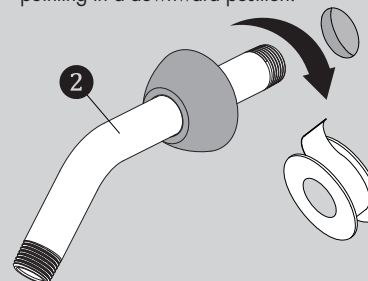

ROUGH IN DIMENSIONS

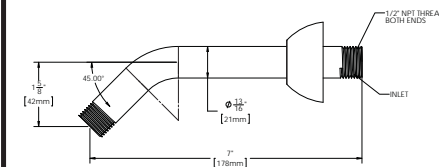
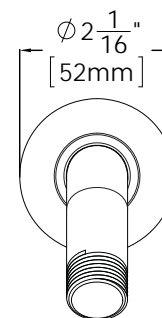

Specifications:

Supply Inlet: 1/2" NPT MALE

Outlet: 1/2" NPT MALE