

Faucet Installation Instructions

ANZZI™

**L-AZ181BN
L-AZ181ORB**

**SINGLE HOLE LAVATORY FAUCET
SOLID BRASS
CERAMIC CARTRIDGE
FLOW RATE:1.2GPM
LIMITED LIFETIME WARRANTY:**

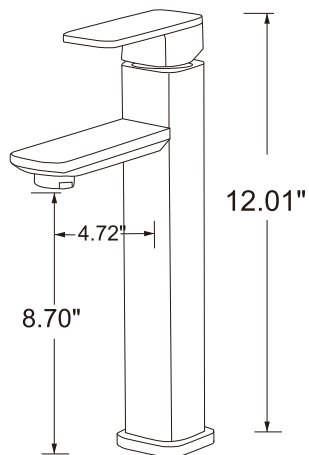
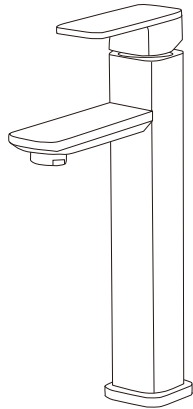

PREPARATION

MAKE SURE TO SHUT OFF THE WATER FLOW FROM YOUR HOT AND COLD SUPPLY LINES.

MAKE SURE YOUR MOUNTING HOLE IS CUT TO SIZE.

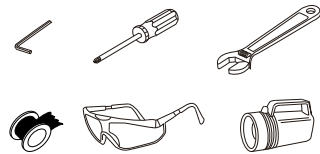

ITEMS YOU MAY NEED.

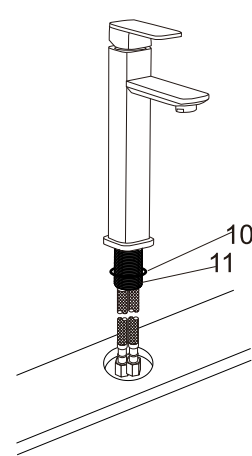

STEP 1

Place O-ring (10) onto the pipe (11) before lowering the pipe through the mounting hole.

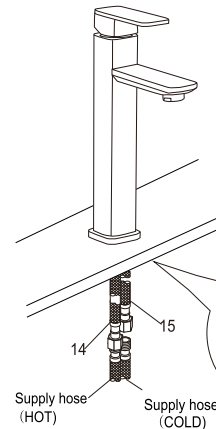
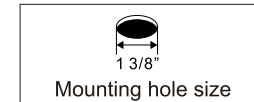

STEP 2

Fix the lock nut (13), metal washer (18) and rubber washer (12) onto the pipe. Tighten the screws (19) to secure. Do not overtighten.

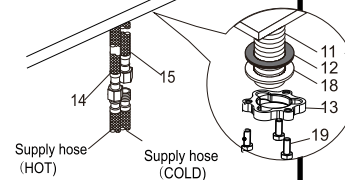

STEP 3

Attach your hot and cold supply lines to the faucet.

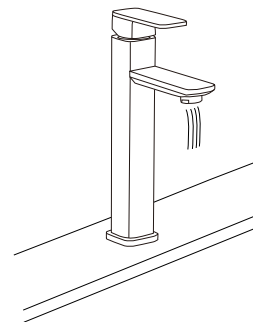

STEP 4

Open the hot and cold supply lines. Take this time to check for leaks. Turn the faucet handle for one and allow the water to flow for one minute to remove any debris from the faucet's interior.

ENJOY!