

Infrared Sauna Instruction Manual

Models MX-M356-01 (SJ-8323)

3 Person Corner Infrared Sauna



FOR INFRARED MODEL SAUNAS
RED CEDAR MODELS
FOR INDOOR USE ONLY
120V/20AMP DEDICATED CIRCUIT REQUIRED

Thank you for choosing our 3-Person Corner Infrared Sauna!

Table of Contents

=====

	Page
Important Safety Guides.....	2
Introduction.....	3
Assembly.....	6
Schematic Diagram.....	7
Sauna Operation.....	14
Tips For Using Your Sauna.....	16
Safety Instructions.....	17
Safeguards For Your Sauna.....	19
Troubleshooting.....	19
Maintenance.....	21
Transportation and Storage.....	21
Warranty.....	22
Warranty Card.....	24

WARNING: Visually inspect all heaters before assembly to make sure they are not damaged. Any excessive vibrations during transport could cause damage to the heating elements. **DO NOT START** the sauna if damage is detected! Contact your dealer or manufacturer for troubleshooting and replacement parts. Parts are subject to change by the manufacturer.

DISCLAIMER

The infrared rays emitted by your sauna are reported to offer a wide range of possible therapeutic benefits based on research completed over the last 25 years from all around the world. These benefits are presented for reference purposes only and no implication of infrared saunas creating a cure for or treating any disease is implied nor should it be inferred. If you have a health condition, are taking prescription drugs, or have acute joint injuries, please consult your medical physician before starting infrared therapy. Persons with surgical implants (metal pins and rods, artificial joints, silicone, or other types of surgical implants) typically do not experience any adverse effects, but should also consult their physician or surgeon before starting infrared therapy. Models are subject to change without notice. Pictures shown are for representation purposes only and may not resemble your exact model.

READ IMPORTANT SAFETY GUIDES BEFORE USING!

READ AND FOLLOW ALL INSTRUCTIONS

- A). Please following all warning labels and markings on the sauna room.**
- B). Do not install any receptacles on the interior or exterior walls of the sauna room.**
- C). No locking devices are installed or shall be installed on the door of the sauna room which could result in entrapment within the sauna room.**
- D). During use, the ceiling vent can be in the opened position.**
- E). CAUTION! Hyperthermia Danger: the normal body temperature can't rise above 103°F. Symptoms of excessive hyperthermia include dizziness, lethargy, drowsiness, and fainting. The effects of excessive hyperthermia may include failure to perceive heat, physical inability to exit sauna, unawareness of impending hazard, unconsciousness and fetal damage in pregnant women. Hyperthermia could make your body's core temperature rise. Setting desired temperature to an excessively high temperature is not recommended.**
- F). Do not use drugs, medications, or consume alcohol prior to or during the sauna session as they may lead to unconsciousness and/or other harmful physical injuries. If absolutely necessary, persons using medications should consult a physician before using the sauna. Some medications may induce drowsiness while others may affect the heart rate, blood pressure, and/or blood circulation.**
- G). WARNING! Your hands must be dry and free of moisture before plugging and unplugging cords and wiring harnesses from the power supply and circuit boards. Never operate the sauna with wet hands or wet feet to avoid risk of electric shock. Never touch the metal prongs of the plug.**
- H). Persons suffering from obesity or with a medical history of heart disease, low or high blood pressure, circulatory system problems, or diabetes should consult a physician prior to using the sauna.**
- I). Do not pour water or any other liquids on the infrared emitters. Do not place combustible materials near on or on the heaters. Do not bump, hit, or break the heating elements as it may cause an electrical short and pose a safety risk.**
- J). To reduce the risk of injury, do not allow children to use the sauna unless they are closely supervised by an adult and use of the sauna has been prescribed by a medical physician.**
- K). If the power supply cord becomes damaged, it must be replaced immediately by the manufacturer or its agent. If you find the power cord is too hot or that the electrical equipment may be experiencing technical problems, please contact the manufacturer or its agent immediately to avoid hazardous conditions.**
- L). Pregnant or possibly pregnant women should contact their physician prior to using the sauna. Excessive temperature has a high potential for causing fetal damage during pregnancy.**

- M). Never sleep inside the sauna.
- N). Do not use any type of cleaning agents on the interior of the sauna. Only wipe down with a cloth and water.
- O). Do not stack or store any object on top or inside the sauna.
- P). Do not use the sauna during an electrical storm to avoid risk of shock.
- Q). Do not attempt to make any repairs yourself. If a problem occurs with the sauna, please contact seller, distributor, or the manufacturer to avoid safety risks. Unauthorized repair attempts will void the manufacturer's warranty.
- R). Please make sure the outlet power supply meets the specifications required. Failure to meet the requirements may cause safety risks.
- S). Some sauna models are equipped with reading and roof lamps. Because the lamp temperature will become very hot once powered on, do not attempt to touch the lamp to avoid being burned. Do not attempt to touch it for at least 20 minutes after it has been powered off.
- T). Do not make any modifications to the sauna, the sauna structure, or the sauna components.

SAVE THESE INSTRUCTIONS

Introduction

We welcome you to one of the most affordable infrared saunas in the nation! We also congratulate you on your new path to better health! Thousands of users enjoy the benefits of infrared saunas every day. Infrared saunas help you burn calories, reduce toxins, relieve pain and even clear complexions. Now you can enjoy the great benefits of far infrared heat within the privacy of your own home.

Health & Beauty Benefits

Relieve pain: The far infrared rays of a sauna accelerate the blood circulation and supply more oxygen to the body. Increased blood circulation diminishes inflammation, relieves pain, and speeds up recovery. Infrared saunas have also been used to treat bursitis, rheumatism, arthritis, and hemorrhoids. Increased blood circulation not only alleviates internal ailments, but also skin conditions such as psoriasis, eczema and scars. Good circulation is essential for smooth and healthy skin.

Burn calories & fat: The far infrared rays of the sauna eliminate extra salt and subcutaneous fat. Burn up to 600 calories in a half hour session versus a half hour of jogging which burns 300 calories or a half hour of cycling- which burns 225 calories.

Relax your body and mind: Use the built-in CD player to listen to your favorite music to relax

and reduce stress. Infrared saunas also improve symptoms of insomnia and other stress related disorders.

Reduce toxins and improve complexions: Perspiring in a lower temperature environment activates the sweat glands and expels toxins and heavy metals from the body.

Highlights

- a. High quality craftsmanship
- b. Automatic thermostat for constant temperature
- c. Timer and buzzer: buzzer sounds 5 minutes before the end of the sauna session
- d. Digital sensor and thermometer
- e. Infrared carbon heat emitter panels
- f.

What Are Infrared Rays?

Infrared is the band of light we perceive as heat. We cannot see this band of light with the naked eye, but we can feel this type of light in the form of heat. Our sun produces most of its energy output in the infrared segment of the spectrum. Infrared rays heat your body without having to heat the air in-between. This process is called conversion.

The infrared is divided into 3 segments by wavelengths measured in microns: Near Infrared – 0.76-1.5 microns; Middle Infrared – 1.5-5.6 microns; and Far Infrared – 5.6-1000 microns. Among these segments, Far Infrared penetrates organic substances such as the human body two to three inches so that the warming effect is very uniform.

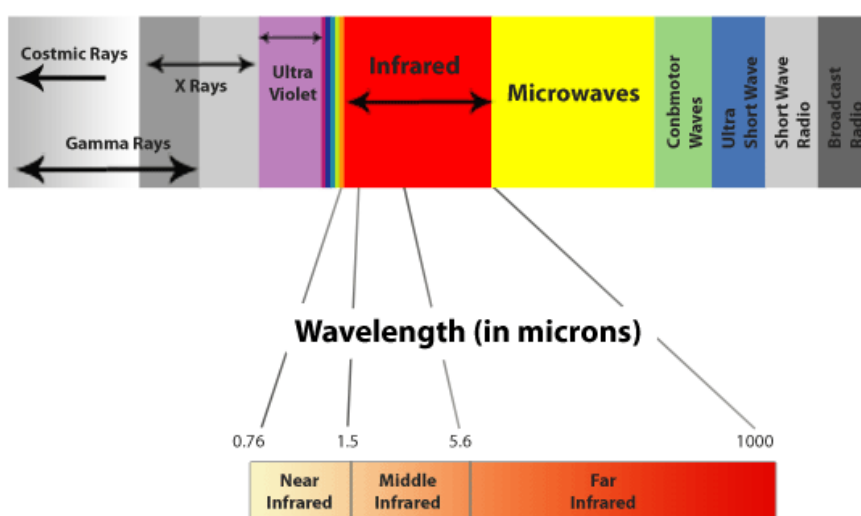

ARE INFRARED RAYS SAFE?

Because infrared rays are part of sunlight, they are not only safe but also highly beneficial to our bodies on a cellular level. Health professionals have used infrared heat lamps for decades to **treat muscle and joint problems**. In hospital baby care units, incubators are often equipped with infrared heating systems to **keep newborn babies warm**.

WHAT IS AN ELECTROMAGNETIC FIELD (also known as EMF)?

An Electromagnetic Field is a physical field produced by electrically charged objects. It is one of the fundamental forces of nature. The field can be viewed as the combination of an electric field and a magnetic field. The electric field is produced by stationary charges and the magnetic field by moving charges referred to as currents. The magnetic field is measured in milligauss (mG). Our sauna products have been developed to have low EMF. Our Low EMF carbon heater panels range between an average of 5mG-10mG at about two inches from the heater panel, our Ultra Low EMF sauna models range between 3mG-5mG, and our Near Zero EMF models range at less than 3mG (NIR heaters range at about 5mG-7mG at the same approximate 2 inches).

EMF Levels from Common Homes Sources

SOURCE	mG up to 4 inches	mG at 3 feet
Blender	50-220	0.3-3
Clothes Washer	8-200	0.1-4
Coffee Maker	6-29	0.1
Computer	4-20	2-5
Flourescent Lamp	400-4,000	0.1-5
Hair Dryer	60-20,000	0.1-6
Microwave Oven	100-500	1-25
Television	5-100	0.1-6
Vacuum Cleaner	230-1,300	3-40
Airplane	50	

Source: USA Environmental Protection Agency

After many years and numerous studies on EMF exposure, no government body including the Occupational Safety and Health Administration (OSHA) have established permissible exposure limits (PEL). Currently, there is no consensus on the potential health hazard from any exposure to EMF. The mainstream scientific evidence suggests that low-power, low-frequency, electromagnetic radiation associated with household currents like that of the infrared sauna does not constitute a short or long term health hazard.

Assembly

Assembly Requirements

Please note that your sauna has been completely assembled and tested at the factory prior to packaging. Please further note that the rear wall panel is intentional warped as part of the overall design. Two adults will be needed to assemble the sauna room.

- a. You will need a Philips screwdriver, ladder, and two adults to assemble.
- b. Do not plug any other appliances into the power supply of the sauna room other than the designated sauna connections/plugs.
- c. Assemble the sauna room on a completely level surface.
- d. Do not spray or get water on the exterior/interior walls of the sauna room. If the floor is damp, install a floor separator to keep the sauna high & dry.
- e. Do not store flammable objects or chemical substances near the sauna.

Sauna Room Assembly:

1. Structure of Infrared Sauna. **See below.**
 2. Make sure all parts are present before installing the unit. See packing list below.
- A. Front Panel B. Floor Panel C. Back Panel D. Left Side Panel E. Right Side Panel**
F. Bench G. Bench Heater Panel H. Roof Panel I. Roof Dust Cover J. Floor Heater
K. Handle

MX-M356-01 (SJ-8323)

Electronic components			
No.	Name	No.	Name
1	Speakers	2	Sensor
3	DC LED light(Color light)	4	MP3 Jack
5	Exterior lights	6	Power supply
7	Control panel with BT		

Power layout			
Location	No.	Dimension	Power
Left rear wall panel	8	NIR HEATER 300W*2=2PCS	600W
Left rear wall panel	9	NIR HEATER 200W*2=1PCS	200W
Right rear wall panel	10	NIR HEATER 300W*2=2PCS	600W
Right rear wall panel	11	NIR HEATER 200W*2=1PCS	200W
Left heater bench panel	12	700*300mm=1PCS	200W
Right heater bench panel	13	700*300mm=1PCS	200W
Floor heater	14	600(600)*198(198)*569=1PCS	200W
TOTAL			2200W

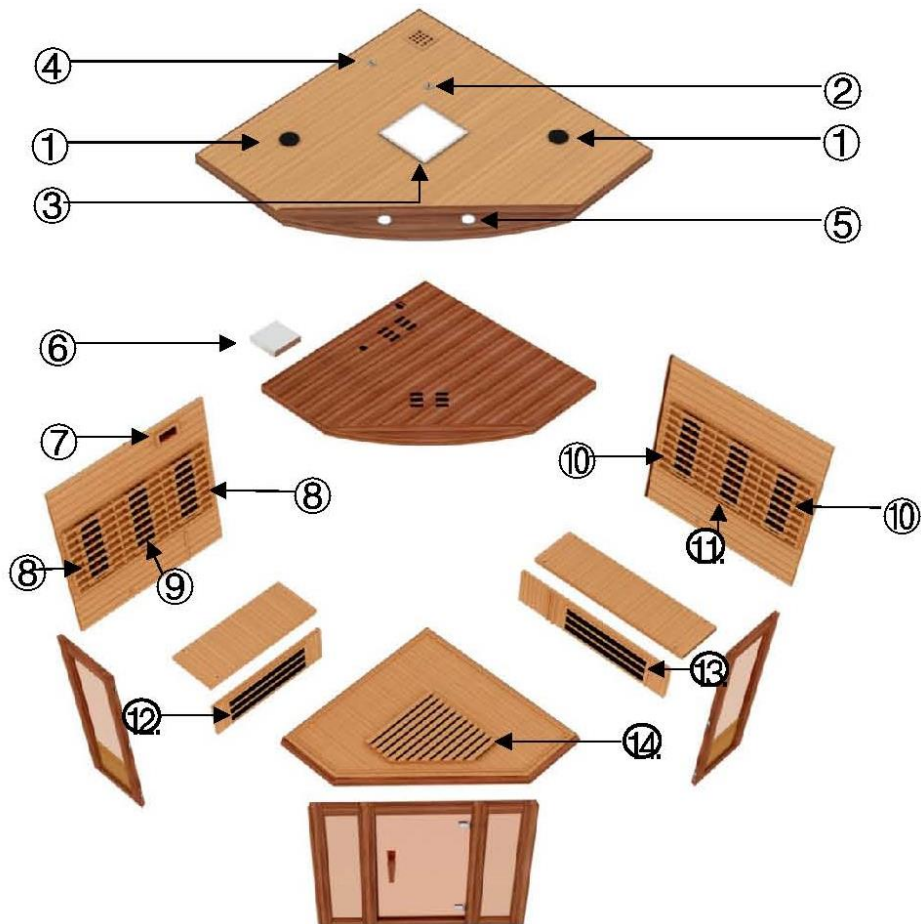

***THE ABOVE ASSEMBLY DIAGRAM IS FOR A QUICK REFERENCE VISUAL GUIDE ONLY. ALL SAUNA MODELS MAY NOT BE SHOWN. PARTS AND ACCESSORIES DO VARY AND ARE SUBJECT TO CHANGE.**

3. 3-person sauna models are packed into three cartons. For example: C/NO: A = A OF ABC.
See FIG-1

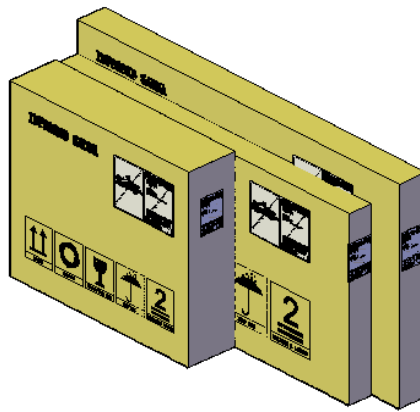

FIG-1 Cartons

4. See the assembly diagram overview below. Please note that the assembly diagram is for a quick reference visual guide only. Parts and accessories may vary and are subject to change. Backrests are sold separately.

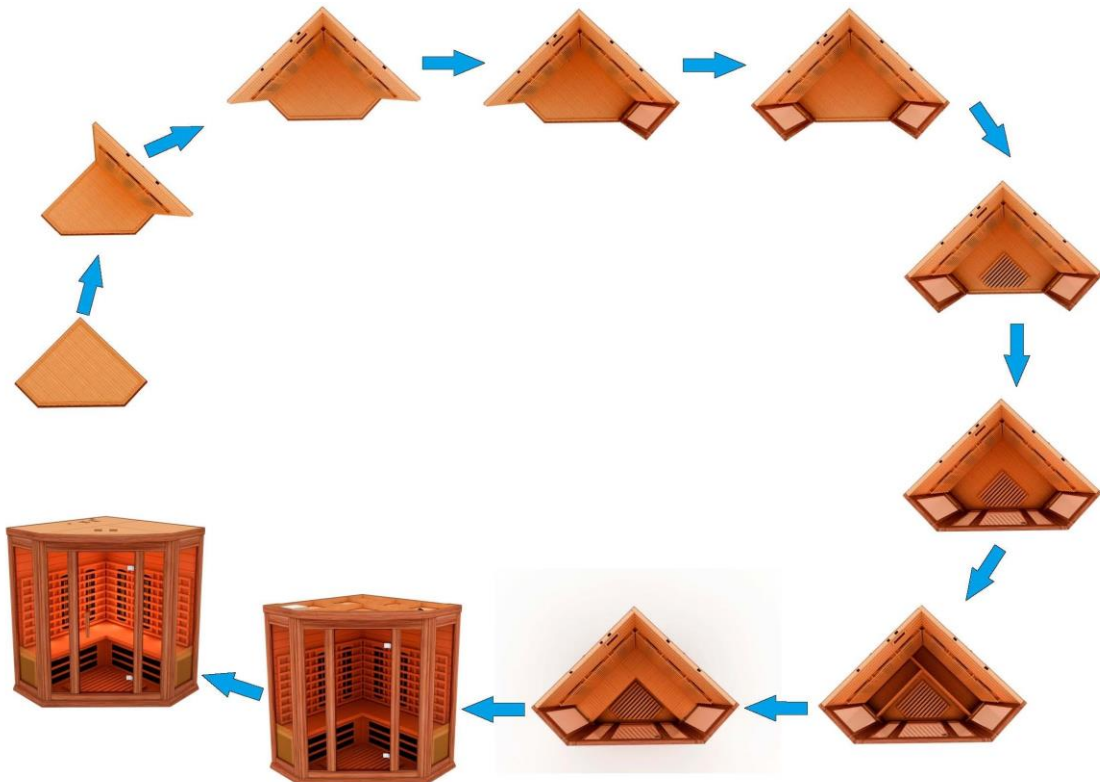

FIG-2 Assembly Diagram

Proceed by placing the Floor Panel on a smooth/flat surface and make sure which sides are the front and which sides are the back. The front of the floor will have a slant. The back does not have a slant. See FIG-3

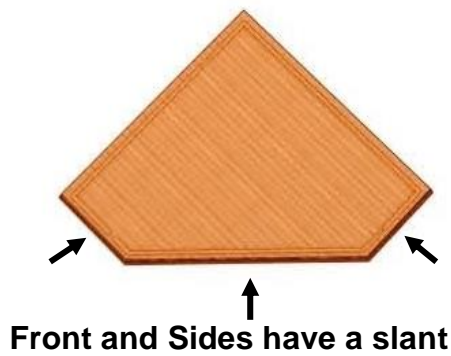

FIG-3 Placing Floor Panel

- Place the Right Back Panel up and onto the Floor Panel. One adult will need to hold the Right Back Panel while the other adult continues to the next step. **See FIG-4**

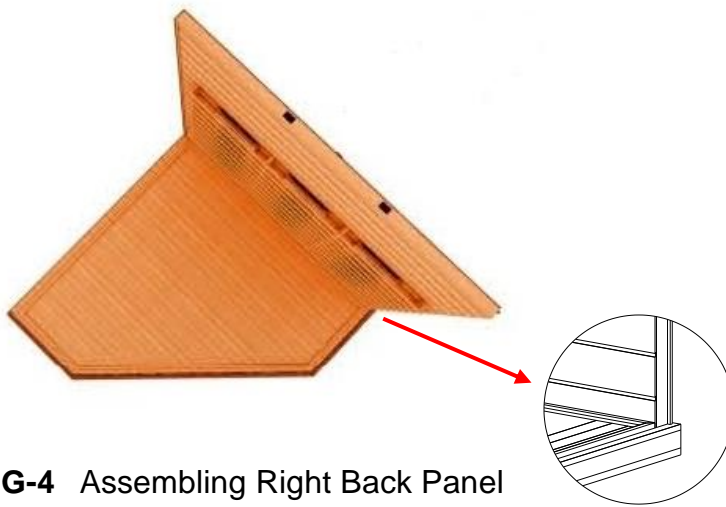

FIG-4 Assembling Right Back Panel

- Align the Left Back Panel with the Floor Panel and Right Back Panel. Be sure that the Left Back Panel fits flush with the Right Back Panel at the top. Use the latches to buckle together. Please note that the buckle has a guide tab that must be placed in the guide slot for alignment. **See FIG-5 and FIG-6**

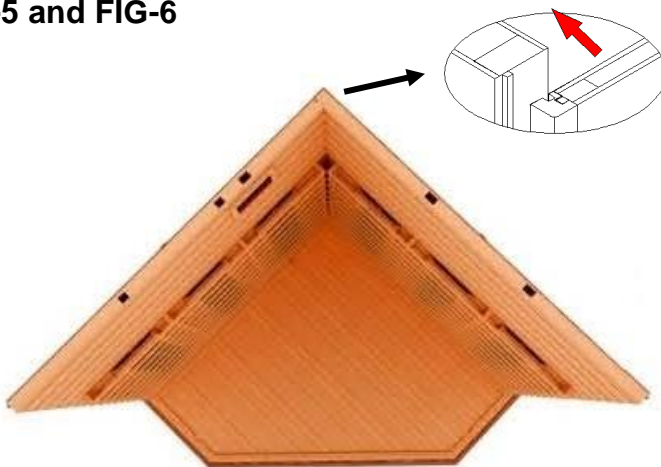

FIG-5 Assembling Left Back Panel

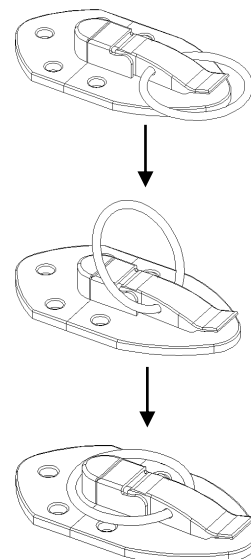

FIG-6 Buckle

7. The Right Back Panel will align with the Right Side Panel. Once they are aligned and fit together snug and tight, use the latches to buckle together. Do the same for the Left Back Panel and Left Side Panel. Please note that the buckle has a guide tab that must be placed in the guide slot for alignment. **See FIG-7**

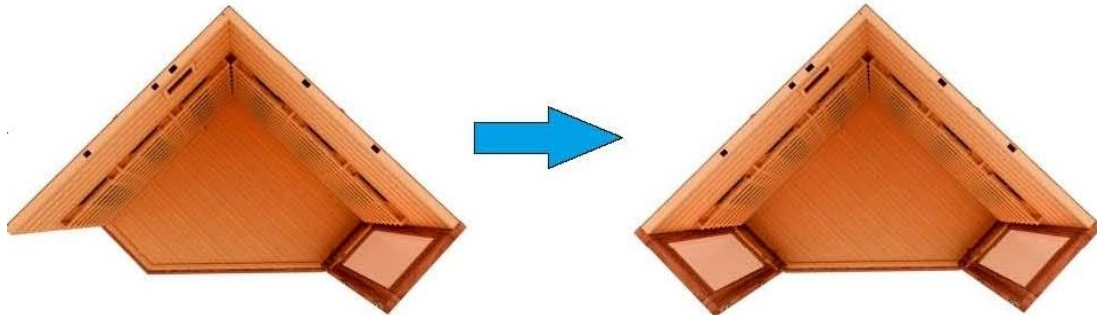

FIG-7 Assembling Right Side and Left Side Panels

8. Lay the Floor Heater onto the Floor Panel as seen in FIG-7. The Floor Heater can either be screwed down to the floor using the provided screws or can be used as a floating heater to be placed in different locations depending on what is comfortable for the user. **See FIG-8**



FIG-8 Installing the Floor Heater

9. **Note: Be cautious with the glass door to avoid breakage.** To assemble the Front Panel, you will need to unbuckle the Right Side Panel from the Right Back Panel. Next, remove the Right Side Panel. Proceed to lift the Front Panel up and onto the Floor Panel and position it so that it is centered on the Floor Panel. Now you can lift the Right Side Panel up and onto the Front Panel locking the guide and guide inserts. Be sure that the Right Side Panel is flush with the Front Panel at the top and then re-buckle the Right Back Panel with the Right Side Panel. It is time to do the same to the Left Side. Unbuckle the Left Side Panel from the Left Back Panel. Now you can lift the Left Side Panel up and onto the Front Panel locking the guide and guide inserts. Be sure that the Left Side Panel is flush with the Front Panel at the top and re-buckle the Left Back Panel with the Left Side Panel. **See FIG-9**



FIG-9 Assembling the Front Panel

10. Next, insert the Long Bench Heater Panel parallel to the Right Back Panel and into the corresponding wood guide slots on the Left Back Panel and Right Side Panel. Insert the Short Bench Heater Panel parallel to the Left Back Panel and into the corresponding wood guide slots on the Left Side Panel and Long Bench Heater Panel. Be sure that both Bench Heater Panels are inserted correctly into the wood guide slots. Next, connect the heater cords to their corresponding connections in the Left and Right Back Panels. Make sure that the connections are snug and tight. **See FIG-10**



FIG-10 Installing the Bench Heater Panels

11. Insert the Benches onto the top of the Bench Heater Panels. Make sure to slide them all the way back and up against both the Right and Left Rear Panels. Secure the Benches using the provided screws. **See FIG-11 and FIG-12**



FIG-11 Installing the Benches

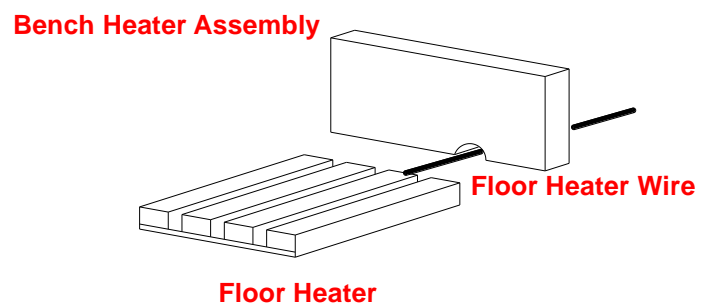

FIG-12 Running the Floor Heater Cord

12. Place (flop) cords/wires coming up to through the top of the wall panels to the outside of the wall panels to avoid damaging the cords/wires during the roof installation. Open the door, lift the Roof Panel up and over the sauna room, and gently lower it into place resting it on the wall panels. Make sure that all of the cords/wires are slipped through the corresponding holes in the Roof Panel. All of the heaters are pre-assembled. Connect the wire connectors and plugs to their corresponding counterparts on the roof top. Make sure the connections are all snug and tight. See FIG-13 - FIG-16



FIG-13 Slip cords/wires through corresponding holes

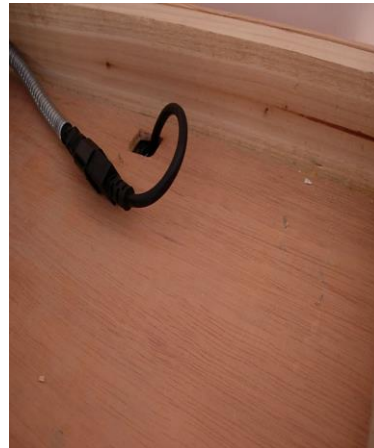

FIG-14 Connecting cords/wires/ connectors

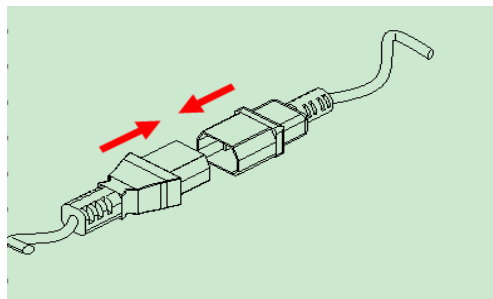

FIG-15 Connect Heater Cords Snug and Tight



FIG-16 Assembling Roof Panel

13. Connect the control panel connectors. **See FIG-17**

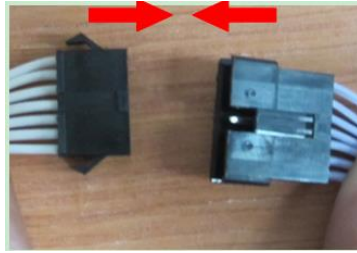

FIG-17 Connecting control panel connectors

16. Make sure all steps are completed correctly. Plug in the power cord to your wall outlet. Turn on the sauna at the control panel to confirm that the control panel is responding. If the control panel responds accordingly, then proceed in putting the Roof Dust Cover onto the Roof Panel. Please note that installing the Roof Dust Cover is optional. By not installing it, the power supply cools down faster, possibly extending the life of the power supply. You can pull the power cord through the corresponding hole in the Roof Cover. **See FIG-18**

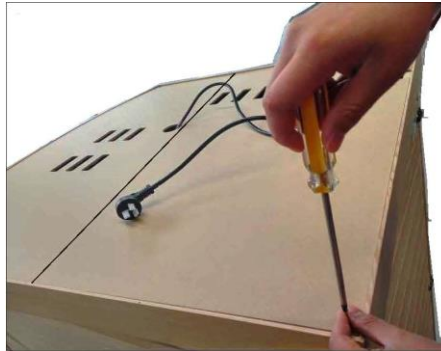

FIG-18 Roof Dust Cover Assembly (optional)

17. Attach the door handle and screw into place. **See FIG-19**



FIG-19 Installing Door Handle

ASSEMBLY COMPLETED.

Sauna Operation

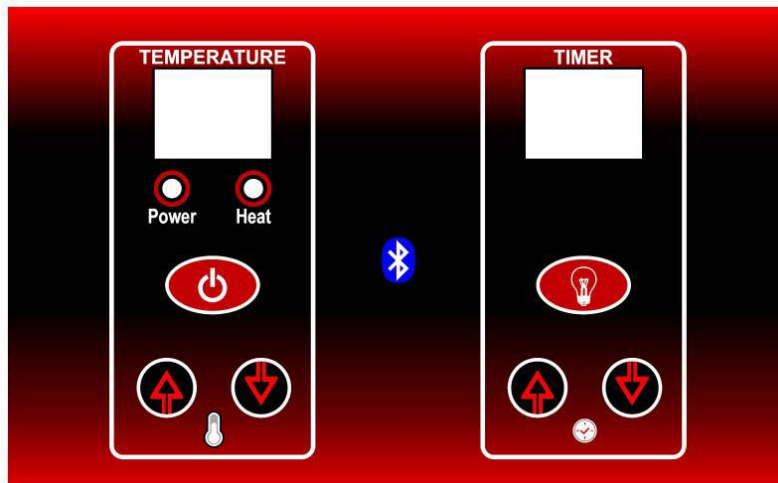



1. Precautions

- a. Please make sure your wall outlet meets the specifications required. Failure to meet the requirements may cause safety risks.
 - a. Set the temperature and time to a comfortable level. The average used temperature range is between 118°F – 122°F. The average sauna session is approximately 20 – 30 minutes. **You must pre-heat sauna room to the desired temperature before entering.**
Note: If the ambient temperature is below 72°F, the sauna will take longer to pre-heat. It is not recommended to use the sauna in an environment with an ambient temperature below 60°F.
 - b. Drink water prior to, during, and after your sauna session to replenish body fluids.
 - c. After 2 hours of continuous use, the sauna needs to be shut down for one hour.
 - d. To avoid burns, do not touch the heating element.

2. Operating The Sauna

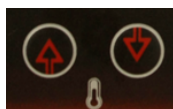

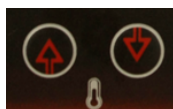



- a. Review the electrical label on the sauna and then plug the sauna into the proper wall outlet. No other appliance can be operated on the same electrical breaker as the sauna when the sauna is in use. Proceed in turning on the sauna room using the ON/OFF button to activate the sauna.
- b. The sauna should be **unplugged** when not in use. If you do not have access to the plug, it is recommended to use a heavy-duty surge protector.



- c. **To set the temperature**, press the  temperature buttons to increase or decrease the temperature to the desired temperature. If the “Heat” light is on, the temperature setting will increase one degree every time the  button is pressed. If



pressed for three seconds, the setting will increase quickly. Decrease the temperature in the same manner by pressing the  button. After the sauna reaches the desired temperature, the "Heat" light will turn off.

d. Press the  button to turn the light ON. If you want to use the **Color Light Therapy System**:

1. While the interior light is ON, press and hold down the  button for 2 seconds. You will notice "2n" in the LED display. This indicates you are in the "light" mode. If you do not press any buttons for approximately 15 seconds, the "2n" will change back to the Timer mode.
2. While the "2n" is displayed, you can now turn the exterior light ON/OFF by pressing the  button in the  section of the control panel.
3. You can also turn the interior light ON/OFF by pressing the  button in the  section of the control panel.
4. While the interior light is on and the "2n" is still displayed in the LED display, you can press the  button to scroll through the different colors within the Color Light Therapy System. You will notice that you have two selections for "white":
 - A. The first selection for "white" will allow the colors to go through a sequence of the different shades of colors.
 - B. The second selection for "white" will continue to display the white light.
5. To return back to the Timer mode, press the  button.



e. You can operate the sauna with the ceiling vent in the open or closed position.

f. After your sauna session is over, you can turn the control panel off by pressing the ON/OFF button. You can unplug the sauna cord or switch the heavy duty surge protector to the OFF position.

g. To set the time, press the  buttons. Press  and  buttons to set the timer from 5 to 60 minutes. If pressed for three seconds, the timer will increase/decrease

quickly. To extend the sauna session, reset the timer again by pressing the .

h. The **Fahrenheit and Centigrade display** can be switched by pressing and holding the

temperature button  and  at the same time and then pressing the .

- i. **The Bluetooth function** is built into the Control Panel. For the Bluetooth function, you first will need to pair your device with the sauna room. Open your device's Settings Menu and then locate and open Bluetooth. You will find "**BT-SAUNA**". Now you can pair your device. Once pairing is successful, your device will be connected. You will control the volume and choose the music on your device.
- j. **The MP3 Jack** will allow you to connect your musical device using the AUX wire. Plug one end of the AUX wire into your musical device and the other end into the MP3 Jack at the ceiling. Do not leave the AUX wire connected at the ceiling when not using this function as it may cause static interference at the speakers. You will control the volume and choose the music on your device. When you disconnect the MP3 wire, the sound system will automatically return back to the Bluetooth mode.

CAUTION: Exit sauna immediately if you feel dizzy, sleepy, or any discomfort.

Tips For Using Your Sauna

1. If you take a hot/warm shower or bath before using your sauna, you may perspire more and experience more comfort.
2. Drink water prior to, during, and after your sauna session to replenish body fluids.
3. To regulate the set temperature inside the sauna to your comfort level, use the movable roof vent or leave the door slightly open. The roof vent is installed on the sauna and used based on personal preference.
4. This is a non-commercial sauna. For every three hours ON, the sauna must be turned OFF for one hour to cool down.
5. Use 2 towels during your sauna session. Fold the first towel several times and place it on the bench. As you sit on this towel, it will absorb a majority of your perspiration while adding comfort as you sit on the bench. Use the second towel to constantly wipe the perspiration from your body to perspire faster and also to avoid having too much perspiration dripping onto the floor heater. If your legs become cold, you can use a third towel to drape over your legs to trap the heat.
6. At the first sign of a cold or flu, increasing your sauna sessions may be beneficial in boosting your immune system and decreasing the reproductive rate of the virus.

7. To help relieve sore and tense muscles, massage the affected areas during your sauna session.
8. To treat your ankles and feet more effectively, you can elevate them and move them close to one of the heat emitters to achieve a deep heating effect.
9. To utilize the sauna's heat therapy effect, put oil and treatment into your hair and wrap it with a towel. After your sauna session is over, rinse your hair thoroughly.
10. The peaceful and relaxed state rendered by a sauna session may help you to sleep easier and deeper.
11. To conserve energy consumption, please unplug your sauna when not in use – especially if you do not plan on using the sauna for an extended period of time.
12. After the sauna session is over, do not jump into the shower or bath immediately. Because your body was heated up during the sauna session, it will continue to perspire even after the heat emitters are off. Sit in the sauna with the door slightly opened and let your body cool down. Once your body has cooled down and you feel comfortable, you can exit the sauna. After about fifteen minutes and when your body has completely cooled down, you can take a shower or bath to clean your body.

Safety Instructions

1. Read and follow all instructions carefully before using the sauna.
2. When assembling and using the electrical equipment, safety precautions should always be followed.
3. To reduce the risk of injury, do not allow children to use the sauna unless they are closely supervised at all times by an adult. Children should not use the sauna unless prescribed or advised by their medical doctor.
4. Do not use the sauna immediately following strenuous exercises. Wait at least 30 minutes to allow the body to cool down completely.
5. Pregnant or possibly pregnant women should contact their medical physician prior to using the sauna. Excessive temperatures have a high potential for causing fetal harm during pregnancy.
6. **Hyperthermia Danger:** The normal body temperature can't rise above 103°F (39°C). Symptoms of excessive hyperthermia include dizziness, lethargy, drowsiness, and/or fainting. The effects of excessive hyperthermia may include, but are not limited to failure to perceive heat, physical inability to exit the sauna, unawareness of impending hazards, unconsciousness, and/or fetal harm in pregnant women. Hyperthermia could make your body's core temperature rise. Setting the desired temperature to an excessively high temperature is not recommended.

7. The use of alcohol, drugs, or medications (prescribed or non-prescribed) prior to or during the sauna session may lead to unconsciousness and/or other harmful physical injuries.
8. Persons suffering from obesity or with a medical history of heart disease, low or high blood pressure, circulatory system problems, diabetes, or other medical conditions should consult with a medical physician prior to using the sauna.
9. Persons using medications should consult with a medical physician before using the sauna. Some medications may induce drowsiness while other may affect the heart rate, blood pressure, and/or blood circulation.
10. Use care when exercising before and after sauna use.
11. Never sleep inside the sauna.
12. Do not use any type of cleaning agents on the interior of the sauna. Only wipe down the sauna room with water and a damp cloth. Never use any chemical based cleaners.
13. Do not stack or store any objects on top of or inside the sauna.
14. If the power supply cord becomes damaged, it must be replaced immediately by the manufacturer or its agent. If you find the power cord is too hot (normally it will become warm) or that the electrical equipment may be experiencing technical problems, please contact the manufacturer or its agent immediately to avoid hazardous situations.
15. Make sure that the electrical outlet is in good working order. A common problem with electrical outlets is loose wiring on the connection points of the terminals of the outlet. A loose wire will also make for a bad connection and cause an unusual amount of heat buildup. Loose connections can also cause sparking in the junction box that can result in arcing. You'll likely see burn marks around the terminals if this occurs. If this happens, do not use the sauna and have the outlet replaced by a certified electrician. If the power cord is damaged, please contact Customer Support.
16. Do not use the sauna during an electrical storm to avoid risk of shock or injury.
17. Do not continuously switch the power ON and OFF excessively as it will compromise the life of the electrical components.
18. Your hands must be dry and free of moisture before plugging and unplugging cords and wiring harnesses from the power supply and circuit boards. Never operate the sauna with wet hands or wet feet to avoid the risk of electrical shock or injury. Never touch the metal prongs of the plug.
19. Do not attempt to make any repairs yourself unless authorized by the manufacturer or its agent. If a problem occurs with the sauna, please contact the manufacturer or its agent immediately to avoid safety risks. Unauthorized repair attempts will void the manufacturer's warranty.
20. Please make sure the outlet power supply meets the specifications required. Failure to meet the requirements may cause safety risks.

21. Some sauna models are equipped with reading and/or roof lamps. Because the lamp temperature will become very hot once powered ON, do not attempt to touch the lamp to avoid being burned. Do not attempt to touch it for at least 20 minutes or until it cools down completely if a need to touch it arises.
22. Do not pour water or any other liquids onto the infrared heat emitters. Do not bump, hit, or break the heating elements as it may cause an electrical short and pose a safety risk.
23. Do not make any modifications to the sauna, the sauna structure, or the sauna components.
24. Prior to each sauna session, the sauna room is to be inspected for correct operation. If for any reason your sauna does not seem to be operating properly, discontinue use and contact Customer Service.

Safeguards For Your Sauna

1. Do not install the sauna near water, near a bathtub (if water will splash on the sauna), near a shower (if water will splash on the sauna), in a wet basement, or near a swimming pool (if water will splash on the sauna).
2. Do not use liquid cleaners or aerosol cleaners on the sauna. Unplug the sauna from the wall outlet before cleaning. Use plain water and a soft damp cloth for cleaning.
3. The power supply cord should be routed so that it is not walked on or pinched by any object that may be placed against it.
4. When replacement parts are required, be sure they meet the specified requirements of the manufacturer. Unauthorized substitutes may result in a fire, electrical shock, or other hazardous situations. After any repairs, please ask the service technician to perform a safety check to determine that the sauna is in good working order.
5. Do not use any wall receptacle adapter or extension cord between the sauna cord and wall outlet. If an extension cord must be used, please have a certified electrician make one that is as short as possible. Make sure it is routed so as to not cause a safety issue, such as individuals tripping over it.

Troubleshooting:

	problem	possible reason	countermeasure
1	indicator light for power supply not working	The connector is not connected properly	Check the connector or replace a new one
		No power supply input	Check your circuit breaker to confirm power at the wall outlet
		Indicator light is broken	replace the circuit panel

2	Indicator light for function is not working	The heating indicator light is broken	Replace the relevant control panel
		The circuit board or components are broken	Replace the circuit board
		The temperature sensor is broken	check the connection of the temperature sensor
3	Infrared Heater not heating up	The heater is broken	Replace heater panel
		The wire junction or the heater's wire is not connected	Check that the connections are sung and tight
		The temperature sensor is broken	check the connection of the temperature sensor
		The circuit board or the relay is not working	replace the circuit board
4	Odor from the sauna	Power supply problem	Power supply may need to be replaced
5	Light bulb is not working	Light bulb is burned out	Remove burned out light bulb and replace it
		Light bulb wiring is loosen	Check connection and/or replace the lamp assembly
		Problems with electrical control panel	Replace the relevant control panel
6	Sauna is not powering up	Power cord is unplug	Plug the power cord into wall outlet
		Outlet has no power	Check your circuit breaker to confirm power at the wall outlet
		Power supply or circuit panel is broken	Replace the power supply or related circuit board
7	The temperature display shows "EP"	The connector of temperature sensor is loose, not connected, or sensor is damaged	Disconnect and reconnect the connector of temperature sensor or change to a new temperature sensor
8	The temperature display shows "H"	The temperature inside the sauna room is too high	Turn off the unit, and contact the manufacturer
9	Speaker does not work	The speaker is broken	Replace with a new one of the same specifications
		The speaker wire is loose	Disconnect and reconnect the speaker connections
		The power indicator light for CD is off	Turn on the switch to start work
10	Bluetooth Connection	Device will not connect to Bluetooth	Check your device and pair with BT-AUDIO

		Device will not connect to Bluetooth	You can only connect a single device at a time. Make sure you do not have any other device connected
		Device will not connect to Bluetooth	Reset the control panel by disconnecting the sauna's power cord from the wall outlet for 15 minutes
		Device will not connect to Bluetooth	Contact Customer Service

Maintenance:

Cleaning

Do not use liquid cleaners or aerosol cleansers inside the sauna. Unplug the sauna from the wall outlet before cleaning. Use plain water and a soft cloth for cleaning. ***Do not use benzene, alcohol, or strong cleaning chemicals in or on the sauna. NOTE: Any chemical that can damage wood or be absorbed into the wood will damage the sauna.***

Transportation and Storage

1. Avoid exposure to rain, snow or other strong weather elements.
2. Do not store in damp environments.

Limited Lifetime Warranty

***Limited Lifetime Warranty:** Golden Designs, Inc. warrants the heating elements and electronics against defects in material and workmanship for the life of the product from the original date of purchase. **This sauna is for INDOOR use only. Placing your sauna outdoors will VOID this warranty. Any damage due to exposure to outdoor elements such as rain, snow, sun, wind or extreme temperatures will not be covered by this warranty. Any damages as a result of modifications made to the sauna or its components will void this warranty.**

Extent of Warranty

This limited warranty applies to products manufactured or distributed by Golden Designs, Inc. under the Dynamic brand name, delivered in the continental United States or Canada and extends to the original purchaser at the original site of installation only. This warranty becomes valid at time of purchase and terminates either by specified time frame listed above, owner transfer, or relocation. **Your sales receipt showing the date of purchase of the product is your proof of purchase.**

Manufacturer Warranty

All Golden Designs, Inc. products are manufactured with the highest quality appliances and are warranted to be free from defects in material and workmanship at the time of delivery. The appliance warranty is extended through the manufacturer for the product including, but not limited to: stereos, CD/DVD players, etc. All exchanged parts and products replaced under this warranty will become the property of Golden Designs, Inc. Golden Designs, Inc. reserves the right to change manufactures of any part to cover any existing warranty. Any parts determined to be defective must be returned to Golden Designs, Inc. to obtain warranty service. You must prepay any shipping charges, export taxes, custom duties and taxes, or any other charges associated with the transportation of the parts. In addition you are responsible for insuring any parts shipped or returned. You must present Golden Designs, Inc. with proof of purchase documents (including the date of purchase). Any evidence of alteration, erasing or forgery of proof of purchase documents will be cause to **VOID** this limited warranty. Products on which the serial number has been defaced or removed is not eligible for warranty service. This warranty covers parts only and does not cover labor.

Warranty Limitations

This warranty does not apply if the unit has been subject to full commercial use, negligence, alteration, modification, misuse, abuse, repairs by non-Golden Designs, Inc. authorized personnel, inappropriate installations, or any case beyond the control of Golden Designs, Inc. invalidating this warranty including but are not limited to:

1. Use of lacquer or paints
2. Sauna and other Golden Designs, Inc. products accessories placed on non-approved surfaces

3. Outdoor applications
4. Normal wear and tear or weathering
5. Use of product not in accordance with instructions

Surface cracks are not considered defects in material or workmanship, as they are normal characteristics of all woods. This includes minor cracks due to wood expansion and contraction. Note: Since the wood used in construction has been kiln dried, a certain amount of expansion and contraction occurs in the wood in a sauna environment.

Disclaimers

Golden Designs, Inc. shall not be liable for loss of use of sauna or other Golden Designs, Inc. products or other secondary or incidental or consequential costs, expense or damages - which may include the removal of permanent deck or other custom fixtures or the necessity for crane removal - arising directly or indirectly out of the use or inability to use the product. Any implied warranty shall have duration equal of the applicable warranty stated above. Under no circumstances shall Golden Designs, Inc. or any of its representatives be held liable for injury to any person or damage to any property, however arising. Specifications are subject to change without notice or obligation.

Legal Remedies

This limited warranty gives you specific legal rights. You may have other rights, which may vary from state to state.

*Limited Lifetime Warranty of Sauna Products is 5 years on heating elements and electronics from the date of purchase.

WARRANTY CARD

Congratulations on your purchase of an Infrared Sauna from Golden Designs, Inc. Please take the time to complete the following Warranty Card and mail it back to:

Text or Call ☎ 800-614-7411
send as an email at support@usbathstore.com

Please include a copy of your sales receipt showing date of purchase as this will serve as proof of purchase.

Warranty will be VOID if the following warranty card is not mailed back within 60 days of purchase date along with proof of purchase.

****Serial number (S/N) is located on the sauna’s front panel, rear panel, or on the carton.****

DETACH HERE



WARRANTY CARD

All fields must be completed to validate the warranty.

Name: _____

Address: _____

City: _____ State: _____ Zip Code: _____

Phone Number: _____

Purchase Date: _____

Product Name: _____

Purchase From: _____

Serial Number: _____