



**GDI-8035-02**  
**3 Person Sauna**



## **OWNER'S MANUAL**

**FOR CARBON MODEL SAUNAS**  
**INDOOR USE ONLY**  
**120VAC 20AMP DEDICATED CIRCUIT REQUIRED**

**Carefully and thoroughly read this Owner's Manual before using/operating the sauna. We recommend keeping this Owner's Manual for regular review and future reference. Parts and accessories may vary and are subject to change.**

## TABLE OF CONTENTS

Packing List	2
Visual Assembly Diagram	6
Parts Description	7
Assembly Instructions	11
Operating the Sauna	20
Tips for Using Your Sauna	23
Safety Instructions	24
Safeguards for Your Sauna	26
Troubleshooting Guide	26
Warranty	33
Warranty Card	35

**WARNING: Visually inspect all heaters before assembly to make sure they are not damaged. Any excessive vibrations during transport could cause damage to the heating elements. DO NOT START the sauna if damage is detected! Contact your dealer or manufacturer for troubleshooting and replacement parts.**

### **Packing List (main panels)**

1pc Front Panel	1pc Left Side Panel	1pc Right Side Panel
1pc Left Side Rear Panel	1pc Right Side Rear Panel	1pc Roof Panel
1pc Roof Dust Cover	1pc Left Bench	1pc Right Bench
1pc Floor Panel	2pcs Himalayan Salt Block Panels	

**NOTE: Your model sauna has been completely assembled and tested prior to packaging. The rear wall panel is intentional warped as part of the overall design. Two adults will be needed to assemble the sauna room.**

**CAUTION: Exit Sauna Immediately If You Feel Dizzy, Sleepy, Or Any Discomfort.**

## What Are Infrared Rays?

Infrared is the band of light we perceive as heat. We cannot see this band of light with the naked eye, but we can feel this type of light in the form of heat. Our sun produces most of its energy output in the infrared segment of the spectrum. Infrared rays heat your body without having to heat the air in-between. This process is called conversion.

The infrared is divided into 3 segments by wavelengths measured in microns: Near Infrared – 0.76-1.5 microns; Middle Infrared – 1.5-5.6 microns; and Far Infrared – 5.6-1000 microns. Among these segments, Far Infrared penetrates organic substances such as the human body two to three inches so that the warming effect is very uniform.

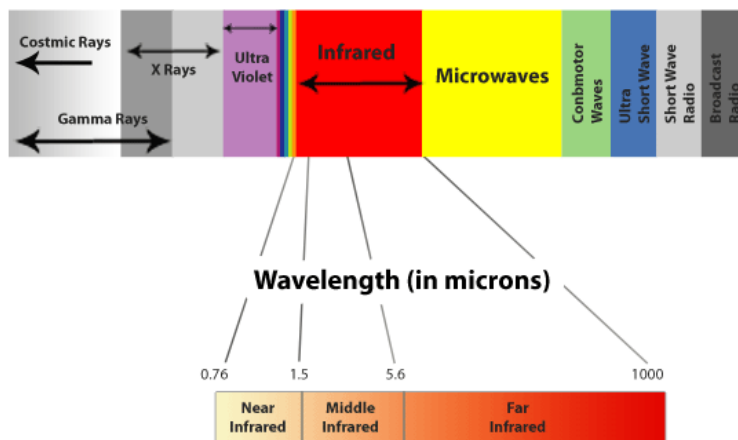

## ARE INFRARED RAYS SAFE?

Because infrared rays are part of sunlight, they are not only safe but also highly beneficial to our bodies on a cellular level. Health professionals have used infrared heat lamps for decades to **treat muscle and joint problems**. In hospital baby care units, incubators are often equipped with infrared heating systems to **keep newborn babies warm**.

## WHAT IS AN ELECTROMAGNETIC FIELD (also known as EMF)?

An Electromagnetic Field is a physical field produced by electrically charged objects. It is one of the fundamental forces of nature. The field can be viewed as the combination of an electric field and a magnetic field. The electric field is produced by stationary charges and the magnetic field by moving charges referred to as currents. The magnetic field is measured in milligauss (mG). Our sauna products have been developed to have low EMF. Our Low EMF carbon heater panels range between an average of 5mG-10mG at about two inches from the heater panel, our Ultra Low EMF sauna models range between 3mG-5mG, and our Near Zero EMF models range at less than 3mG (NIR heaters range at about 5mG-7mG at the same approximate 2 inches).

## EMF Levels from Common Homes Sources

SOURCE	mG up to 4 inches	mG at 3 feet
Blender	50-220	0.3-3
Clothes Washer	8-200	0.1-4
Coffee Maker	6-29	0.1
Computer	4-20	2-5
Flourescent Lamp	400-4,000	0.1-5
Hair Dryer	60-20,000	0.1-6
Microwave Oven	100-500	1-25
Television	5-100	0.1-6
Vacuum Cleaner	230-1,300	3-40
Airplane	50	

Source: USA Environmental Protection Agency

After many years and numerous studies on EMF exposure, no government body including the Occupational Safety and Health Administration (OSHA) have established permissible exposure limits (PEL). Currently, there is no consensus on the potential health hazard from any exposure to EMF. The mainstream scientific evidence suggests that low-power, low-frequency, electromagnetic radiation associated with household currents like that of the infrared sauna does not constitute a short or long term health hazard.

### DISCLAIMER

The infrared rays emitted by your sauna are reported to offer a wide range of possible therapeutic benefits based on research completed over the last 40 years from all around the world. These benefits are presented for reference purposes only and no implication of infrared saunas creating a cure for or treating any disease is implied nor should it be inferred. If you have a medical/health condition, are taking prescription drugs, or have acute joint injuries, please consult with your medical physician before using the sauna. Persons with surgical implants (metal pins/rods, artificial joints, silicone, or other types of surgical implants) typically do not experience any adverse effects, but should also consult their medical physician or surgeon before using the sauna room.

## HOW IT WORKS

Infrared Saunas differ from traditional saunas in that they use infrared radiant energy to directly penetrate into the body's tissue to produce perspiration. Traditional saunas use steam to heat the air inside the sauna, which then heats your body until you begin to perspire. In order for this to be effective, temperatures would need to reach in the upwards of 190 degrees Fahrenheit. Infrared saunas only need a temperature of up to 120 degrees Fahrenheit to obtain the same effect. This lower temperature makes the environment more tolerable and allows you to breathe easier.

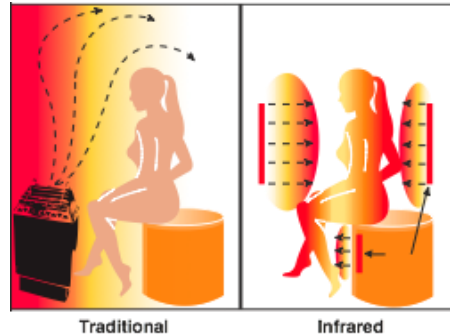

## Health Benefits

Because infrared rays penetrate the body through convection, there is a deep heating effect in both the muscle tissues and internal organs without putting too much burden on the heart.

Our body reacts to the increased heating through the natural cooling process of perspiring. Through the perspiration process, acid and waste residue like toxins, sodium, alcohol, nicotine, cholesterol, and the potentially carcinogenic heavy metals are removed from the cells (especially zinc, lead, nickel, cadmium, etc.). The pores of our skin open and discharge waste products shedding any old skin cells leaving the skin glowing and clean, with improved tone, elasticity, texture, and color.

### Health Benefits Include, But Are Not Limited To:

- |  |                           |                     |
|--|---------------------------|---------------------|
| *Pain relief from Rheumatoid Arthritis | *Relaxes muscle spasms    | *Reduces cellulite  |
| *Increases blood circulation           | *Clears, rashes, acne     | *Enhances skin tone |
| *Cardiovascular conditioning           | *Reduces stress & fatigue | *Removes toxins     |

## Sauna Maintenance

Since infrared saunas do not require hot rocks, water, or steam to operate, they require very little maintenance. You can simply wipe it down with water – use a damp, soft, and clean cloth. **Do not use any chemical based cleaning agents** as they can be absorbed into the wood and be released into your sauna during use.

**\*PLEASE READ INSTRUCTIONS BEFORE ASSEMBLY\***

**Visual Assembly Diagram**

**GDI-8035-02**

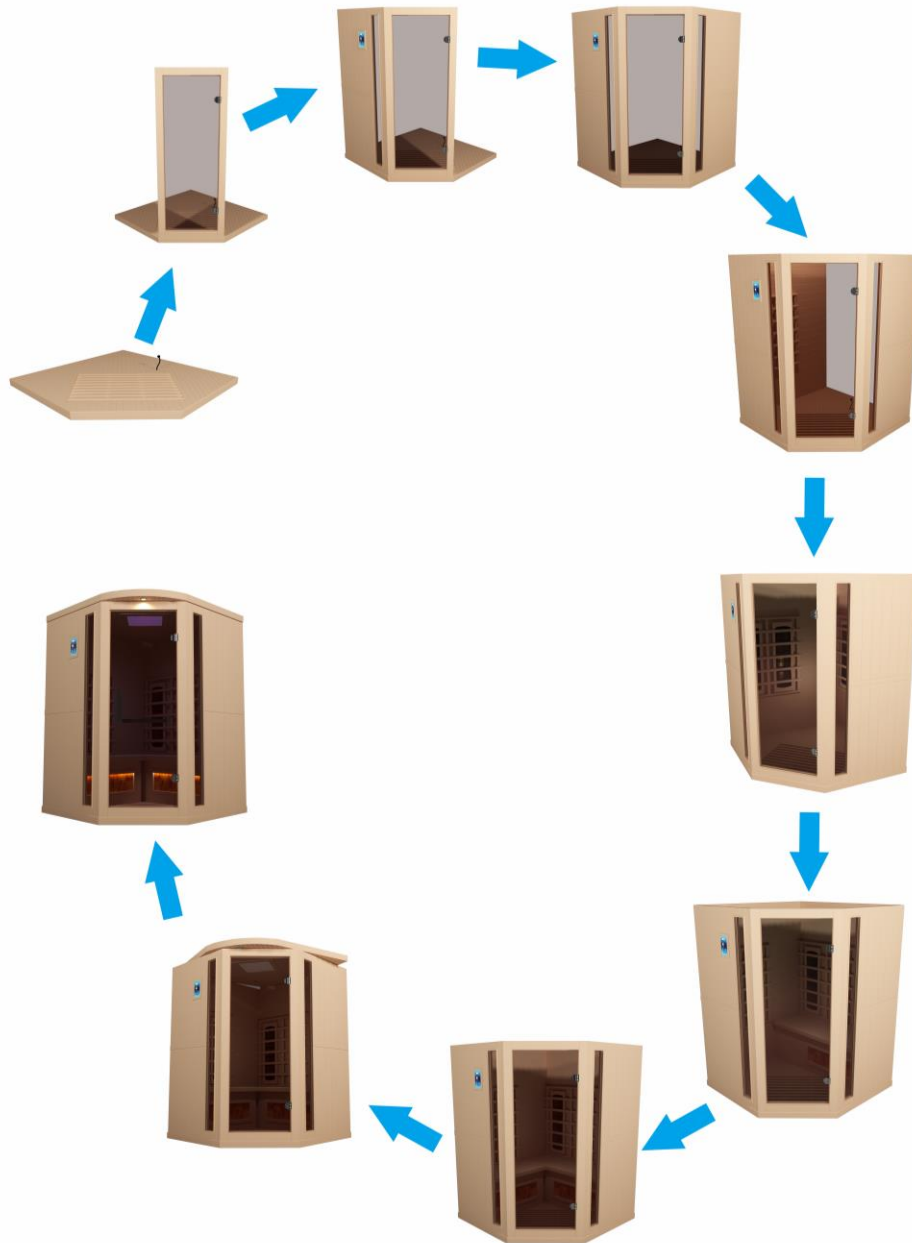

**\*The above assembly diagram is for a quick reference visual guide only. All sauna models are not shown. Parts and accessories may vary and are subject to change. Backrests are sold separately.**

# PARTS DESCRIPTION

GDI-8035-02

Electronic Components			
No.	Name	No.	Name
1	Power Supply	2	Color Therapy
3	Temp sensor	4	Speakers
5	Roof Lights	6	Control Panel
7	Radio		

Power Layout			
Location	No.	Dimension	Power
Left rear wall panel	8	NIR Heater	300W
	9	NIR Heater	300W
Right rear wall panel	10	NIR Heater	300W
	11	NIR Heater	300W
	12	NIR Heater	300W
Right side wall panel	13	750*400mm	200W
Floor heater	14	750*500mm	300W
Left side wall panel	15	750*400mm	200W
Total Power			<b>2200W</b>

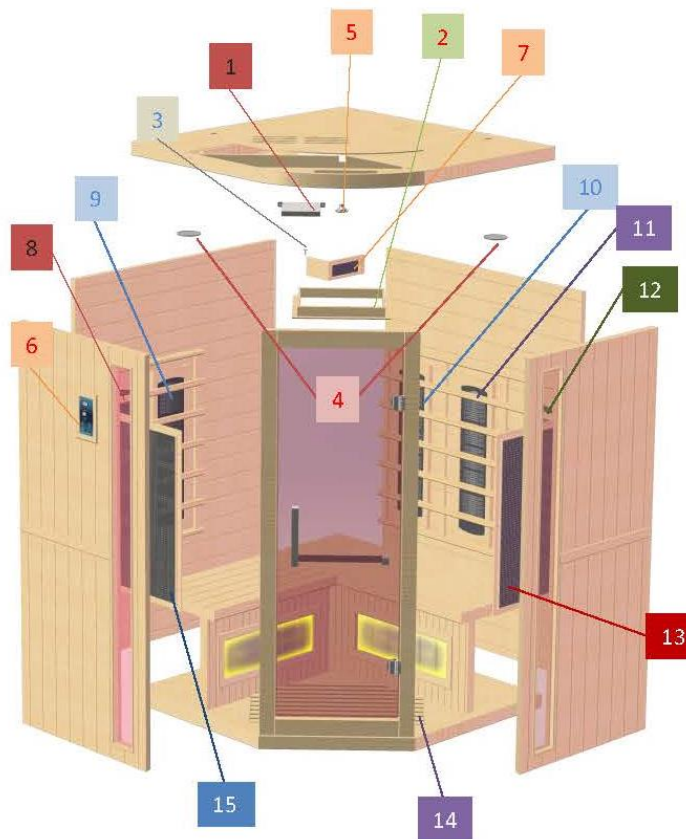

**NOTE: The pictures and diagrams shown within this owner's manual are representations of this model. Actual model may vary. Design and Construction are subject to change. Backrests are sold separately.**

## I. Power Supply (Control Box)

The POWER SUPPLY is the control center of the sauna room. It is installed on the topside of the ROOF PANEL and has inputs/outputs connected to it. (see Figure 1)

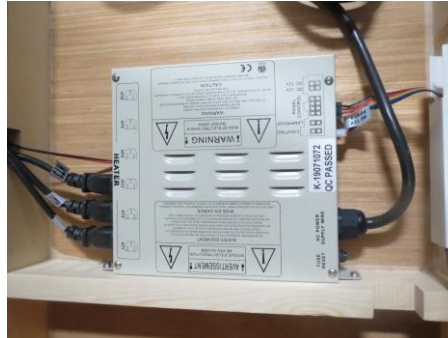

Figure 1

**POWER IN** - main power of the sauna room  
**HT1, HT2, HT3, HT4, HT5, HT6** – heat emitter cords  
**LAMP/ROOF** – roof lamp power (optional)  
**LIGHTING** – chromotherapy lights  
**PANEL CONTROL** – control panel  
**FUSE RESET** – protects against power

## II. CD/Radio

The multifunction stereo features an FM receiver, CD player, colorful and wide LCD screen, volume/tone/balance controls, and an AUX input. (see Figure 2)



Figure 2 (Model Radio May Vary And Is Subject To Change)

## III. Component Labeling

**Power Cord** – Main power cord connects the POWER SUPPLY to the dedicated wall outlet



**HT1, HT2, HT3, HT4, HT5, HT6** – Heater cords connect the heat emitters to the POWER SUPPLY at these ports (HT5 & HT6 are not used on most models)

**Lighting** – Connects the interior lighting to the POWER SUPPLY at this port

**LampRoof** – Connects the exterior roof lights to the POWER SUPPLY at this port

**Panel Control** – Connects the Control Panel through the CTRL harness to the Power Supply at this port

**L/R Speakers** – Connects the speakers through these wires to the Control Panel

**Temp Sensor** – Connects the Temperature Sensor through this wire to the Control Panel

#### IV. Buckles

##### A. External Buckles

The external buckles are used to connect the REAR WALL PANEL to the LEFT SIDE WALL PANEL and RIGHT SIDE WALL PANEL. The Metal Guide Insert Brackets connect the FRONT WALL PANEL to the LEFT SIDE WALL PANEL and RIGHT SIDE WALL PANEL. (see Figure 3 and 4)

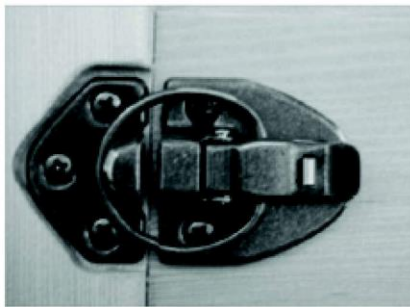

Figure 3

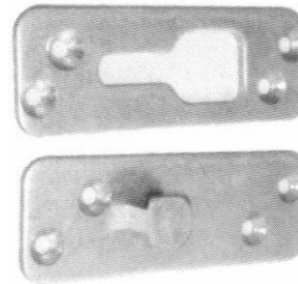

Figure 4

#### V. Panel Descriptions

For easier installation, please understand and distinguish the differences between each panel.

## A. Floor Panel

When the floor panel faces upward, you will find that the edges are raised. The wall panels will seat inside of the raised edge. The front of the floor panel is indicated below. Please note the correct position before you began assembling the wall panels. (see figure 5)

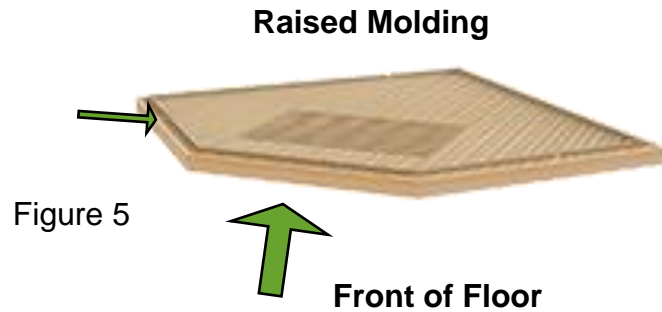

## B. Understanding Difference Between The Top And Bottom Of The Wall Panels

**The wall panels are in the upright position when the heater cords can be seen at the top of the wall panels.** Place the heater cords to the outside of the sauna room before the roof is placed on top of the unit. These heater cords will be feed through the roof panel and connected once the roof panel is placed on top of the sauna room. (see Figure 6)



Figure 6

### C. Rear Panels

If you are facing the front of the sauna, the rear panel with the heat emitter panels on the interior will be the inside of the sauna room. (see Figure 7)

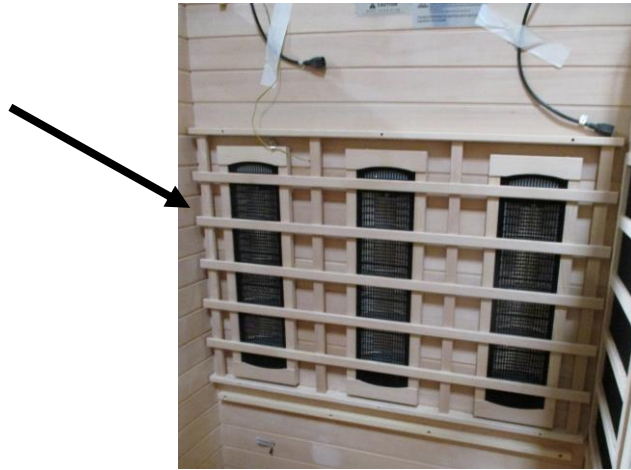

Figure 7

## Assembly Instructions

### A. Choose a good location to assemble the sauna

1. The location must be dry, leveled, and away from any source of water.
2. MAIN POWER cord must be easily accessible.
3. Two adults are required for installation.
4. Wood cabin installation order: Floor Panel ► Front Panel ► Left Side Panel ► Right Side Panel ► Left Side Rear Panel ► Right Side Rear Panel ► Bench Emitter Panels ► Benches ► Roof Panel ► Roof Cover
5. Tools Required: Philips Screwdriver and Ladder

### B. Installing the FLOOR PANEL

1. Place the FLOOR PANEL on the floor. Turn the FLOOR PANEL right side up and make sure the front is positioned correctly. (see Figure 8)



**C. Installing the FRONT PANEL, LEFT SIDE PANEL, and RIGHT SIDE PANEL**

1. Determine the correct placement of the FRONT PANEL in the figure diagram below. Insert the FRONT PANEL onto the FLOOR PANEL. Then place the LEFT SIDE PANEL onto the FLOOR PANEL next to the FRONT PANEL. Lift the LEFT SIDE PANEL up and onto the guide brackets on the FRONT PANEL. You will need to make sure the walls are properly inserted into one another and that the LEFT SIDE PANEL is pulled all the way down and level with the FRONT PANEL at the top. The process for the RIGHT SIDE PANEL will be the same. Place the RIGHT SIDE PANEL next to the FRONT WALL PANEL. Lift the RIGHT SIDE PANEL up and onto the guide brackets on the FRONT PANEL. You will need to make sure the walls are properly inserted into one another and that the RIGHT SIDE PANEL is pulled all the way down and level with the FRONT PANEL at the top. (see Figure 9)



Figure 9

**D. Installing the RIGHT SIDE REAR PANEL AND LEFT SIDE REAR PANEL**

1. Determine which is the RIGHT SIDE REAR PANEL and which is the LEFT SIDE REAR PANEL (see V. Panel Descriptions Figure 7). The LEFT SIDE REAR PANEL will have a cutout for the radio. Next, insert

the LEFT SIDE REAR PANEL onto the FLOOR PANEL. The LEFT SIDE REAR PANEL will fit like a puzzle with the LEFT SIDE PANEL. Once they are inserted properly, you can buckle the two walls together. The RIGHT SIDE REAR PANEL will be a bit tight in installing. You will want to insert the bottom first onto the FLOOR PANEL and carefully work the top into place. Once the RIGHT SIDE REAR PANEL is properly inserted, you can buckle it to the RIGHT SIDE REAR PANEL and LEFT SIDE PANEL. (see Figure 10 and Figure 11)



Figure 10



Figure 11

2. To install the DOOR HANDLE, first locate the DOOR HANDLE. It may need to be dismantled in order to install. Next, place the long handle section horizontally and install it on the glass door from the inside. You will need to secure the side of the long horizontal handle closest to the hinge side of the glass door by screwing it to the glass door. Now you can locate the shorter handle and connect it on the exterior side of the glass door to the long horizontal handle. It will need to attach to the long handle and rotate clockwise. Finally, you can secure the other end of the vertical handle by screwing it to the glass door. (see Figure 12)

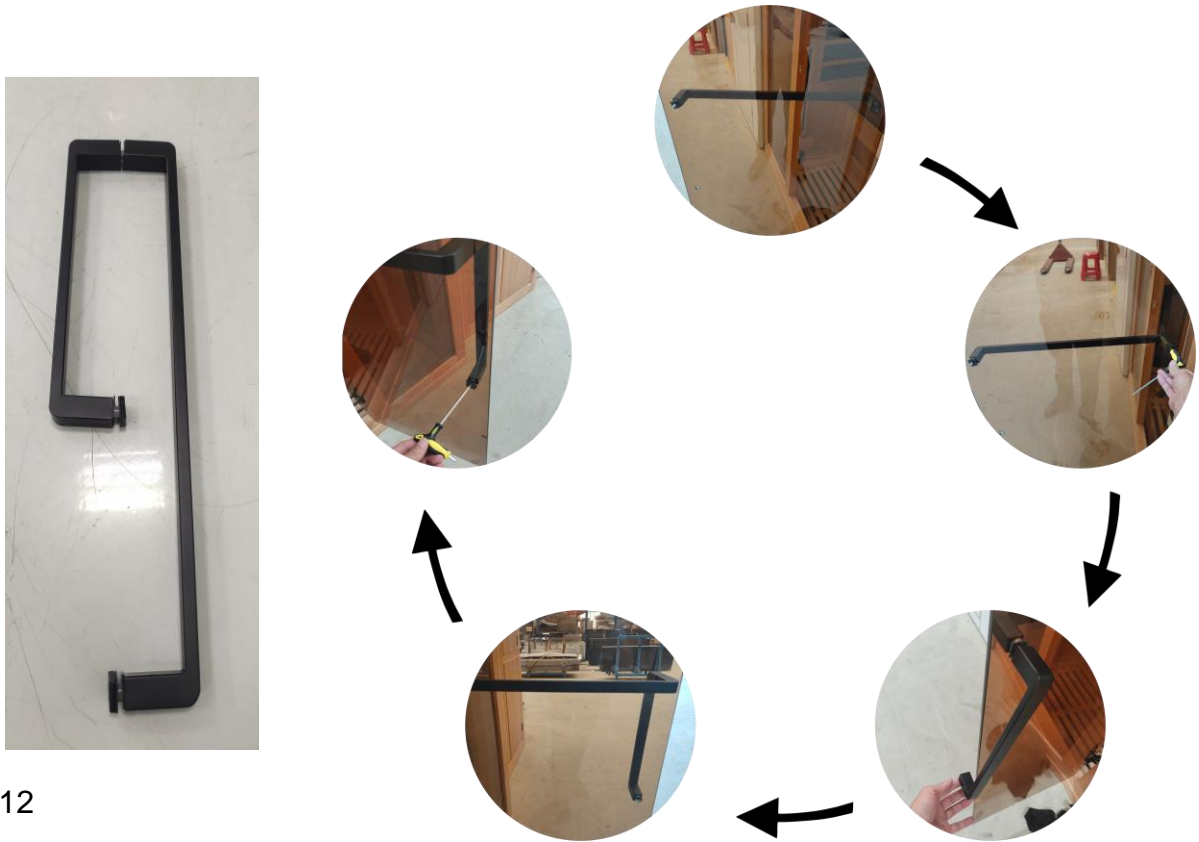

Figure 12

### E. Installing the ROOF PANEL

1. The side with the slight curve is the front of the ROOF PANEL. The power supply box faces upward on the ROOF PANEL.
2. The edge nearest the power supply is the front of the ROOF PANEL. Be careful of the wires coming from the SIDE and REAR PANELS when you set the ROOF PANEL down onto the panels. Feed the wires through the holes in the ROOF PANEL. Feed the control cable and CD connectors down from the ROOF PANEL through the long-shaped hole to the inside of the sauna (for CD/radio hookup). (see Figure 13 and Figure 14)
3. Be careful not to force the ROOF PANEL into place. Make sure that the wires are properly fed through the holes.
4. When all the wires are fed through their appropriate holes, lower the ROOF PANEL into place.



Figure 13



Figure 14

#### **F. Installing the HIMALAYAN SALT BLOCK PANEL, BENCH EMITTER PANEL, and BENCHES**

1. First, locate the FLOOR HEATER power cord. Connect the power cord into the wall outlet on the RIGHT SIDE REAR PANEL towards the back corner of the sauna room. (see Figure 15)
2. Locate the (2) square wood frames that have two cutouts (the cutouts will be installed facing the stationary glass panels) on one side and a vertical slot on the other side. Again, place one of the wood frames next to the glass window with the two cutouts facing the glass window and the vertical slot facing towards the front. The cutouts fit along the glass window moldings. The wood frames are **not** interchangeable and so make sure you have them next to the correct glass window. Do the same with the second wood frame next to the other glass window. (see Figure 16)
3. Slide down the longer of the two HIMALAYAN SALT BLOCK PANELS by lining up its sides with the vertical guides on the side panel and wood frame. The finished side of the HIMALAYAN SALT BLOCK PANEL will face outward (toward the front of the sauna) and the light wire will be at the top of the HIMALAYAN SALT BLOCK PANEL on the inside (this would be underneath the bench once the bench is installed). You will need to connect the light wire to the applicable connection coming from the RIGHT SIDE REAR PANEL. Make sure to push the HIMALAYAN SALT BLOCK PANEL all the way down until it is touching the FLOOR PANEL and is secured in place. Do the same with the shorter HIMALAYAN SALT BLOCK PANEL. Also connect the light wire to the applicable connection coming from the LEFT SIDE REAR PANEL. (see Figures 17 and 18)
4. Install the longer of the two BENCHES first by tilting the end at the LEFT SIDE REAR PANEL and carefully guiding the other end

downward and into position. Then slide the shorter of the two BENCHES into its position. Push the BENCHES all the way in until they touch the REAR PANELS and are secured in place. Make sure to install the BENCHES with the smooth and finished sides facing up and the predrilled holes at the rear. It is optional if you would like to mount the benches using the provided screws. (see Figure 19 and Figure 20)

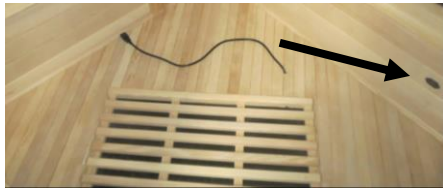

Figure 15

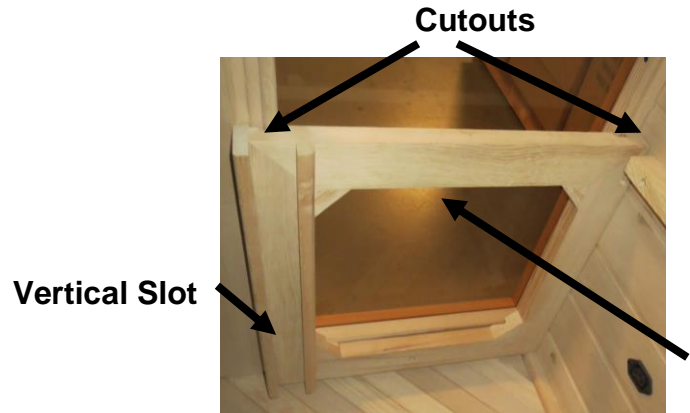

Figure 16



Figure 17



Figure 18



Figure 19



Figure 20



## G. Connecting the plugs on the ROOF PANEL

1. Connect the plugs according to their respective labels. (see Figure 21)
2. You will need to connect the right and left speaker, the MP3, the CTRL (Panel Control), and the CD/SIG (radio power). The CD/SIG will be connected once the radio is installed in step 9 below. (see Figure 22 and 23)

### Before Connecting

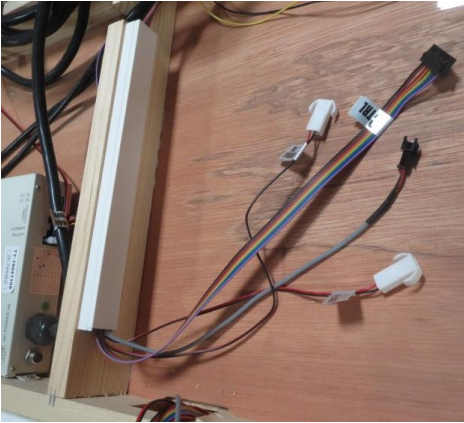

Figure 21

### After Connecting

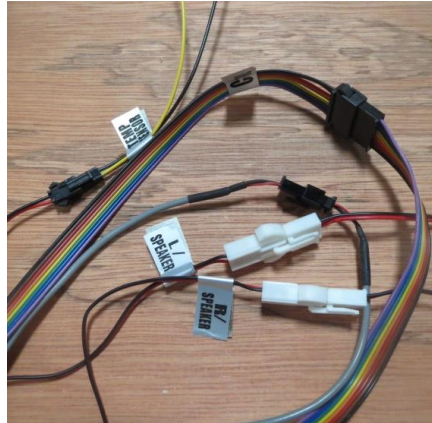

Figure 22



Figure 23

## H. Installing the TEMPERATURE SENSOR and optional accessories (varies by model)

1. Enter the sauna and remove the protective covering (masking tape) from the TEMPERATURE SENSOR. Situate the TEMPERATURE SENSOR so that it is vertical and pointing downward. (see Figure 24)



Figure 24

**Note: Some sauna models are shipped with a spare TEMPERATURE SENSOR in case the TEMPERATURE SENSOR is damaged during transit. The manufacturer decides this according to sauna models and packaging.**

2. If your sauna comes with the **optional** shelf and/or aroma therapy dish, use the screws provided to mount the shelf and aroma therapy dish where indicated within the sauna room. (see Figure 25 and 26)



Figure 25



Figure 26

#### I. Installing RADIO HOUSING BOX and RADIO (radio model subject to change)

1. **If your RADIO HOUSING BOX is already assembled, then proceed to step 4.** Locate the wood sides for the RADIO HOUSING BOX. There is one for the front, side, and bottom. (see Figure 27 and Figure 32)
2. Attach "A" on the side panel with "A" on the bottom panel and attached with the screws.
3. Attach "B" on the front with "B" on the side panel and "C" on the front panel with "C" on the bottom panel and attached with the screws.
4. Screw the Radio Housing Box to the REAR PANELS. The back opening (the larger opening) on the Radio Housing Box will face the RIGHT REAR PANEL. The front opening (the small opening and where the radio is inserted) on the Radio Housing Box will face the LEFT SIDE PANEL
5. Locate the RADIO and remove it from any packaging. (see Figure 30) Be sure to remove the transport screws from the top of the radio.
6. Connect the plug from the RADIO with the plug coming down from the roof and the left/right speaker plugs. Note that the power for the radio comes from the wire harness leading to the power supply at the "DC 12V" port. (see Figure 28 and 29)
7. Connect the antenna plug to the back of the radio. (see Figure 31)
8. Insert the RADIO into the RADIO HOUSING BOX. It is not necessary to mount the RADIO once you slide it into the RADIO HOUSING BOX because the RADIO will just sit in place. (see Figure 32)

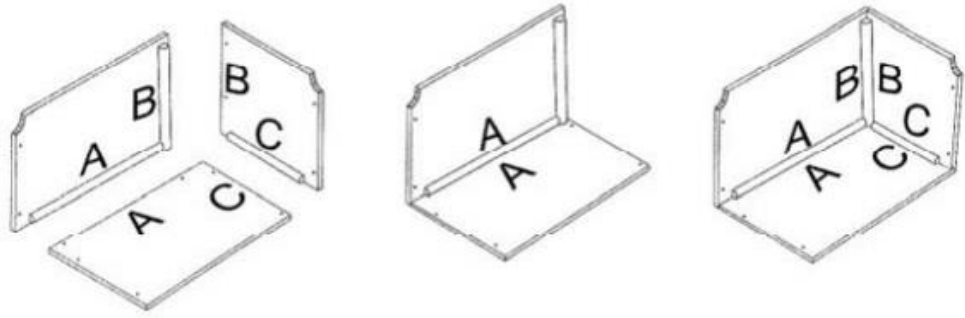

Figure 27

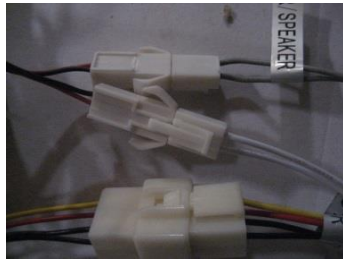

Figure 28



Figure 29



Figure 30



Figure 31



Figure 32

## **J. Putting on the ROOF COVER (optional)**

1. Place the ROOF COVER over the top of the sauna. Be cautious when pulling the power cord through the hole in the roof cover. Slide the antenna through the slot allotted. Gently place the ROOF COVER onto the ROOF PANEL. When the edges are aligned, screw the ROOF COVER to the roof panel. (see Figure 33)



Figure 33

## **Assembly Completed**

### **Operating the Sauna**

**NOTE:** Before the sauna is turned on, remove plastic protective covering from the CONTROL PANELS. Please check and confirm that the connections to the POWER SUPPLY (including the power cord), HEAT EMITTERS, CD/RADIO, and TEMPERATURE SENSOR are connected properly and are snug and tight. The power supply voltage and frequency must match the requested voltage and frequency of the sauna (120VAC 20AMP Dedicated Circuit). Please consult a certified electrician for any electrical modifications or repairs.

Since many materials absorb the infrared rays, minimal clothing is recommended for maximum effect. The infrared sauna emitters are designed to heat you and not necessarily the air inside the sauna. It is not a hot box like a traditional sauna. The temperature gauge is a guide for your safety. It is recommended that you drink water before, during, and after sauna use to prevent dehydration since body fluids will be lost through perspiration. It is not recommended to shower immediately after use since the pores in your skin will be open and could possibly absorb anything in the water.

## CAUTION: Exit Sauna Immediately If You Feel Dizzy, Sleepy, Or Any Discomfort.

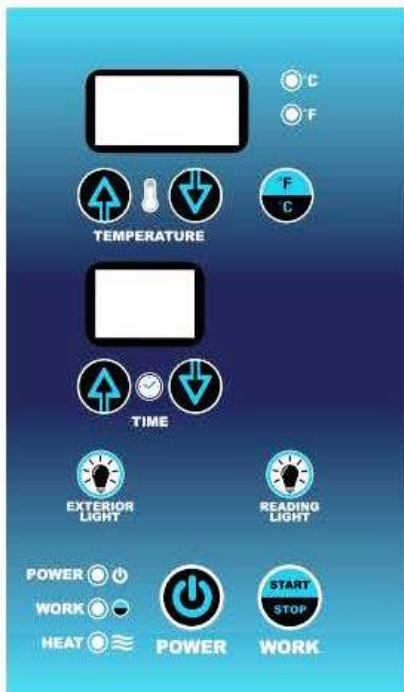

### Control Panel

**Power On/Off:** Press to control the main power of the sauna

**Power Indicator:** Indicates the status of the sauna's main power

**Work Start/Stop:** Press to control the working functions of the sauna

**Work Indicator:** Indicates the working status of the sauna

**Heat Indicator:** Indicates the status of heating function

**Light:** Press to control the lighting function

**Time Display:** Displays the heating time of the sauna in minutes

**Time:** Press to adjust the setting of the timer

**Temperature Display:** Displays the actual interior temperature of the sauna room in  $^{\circ}\text{C}/^{\circ}\text{F}$

**Temperature:** Press to adjust the temperature setting

**$^{\circ}\text{C}/^{\circ}\text{F}$ :** Press to change the temperature display between  $^{\circ}\text{C}/^{\circ}\text{F}$

1. Plug the sauna into the wall outlet.
2. Press the POWER button once. The POWER light will come on, the TIME DISPLAY will show 90 (minutes), the TEMPERATURE DISPLAY will show  $151^{\circ}\text{F}$  /  $66^{\circ}\text{C}$ , and the control panel will flash.
3. Press the up/down arrows under the TIME DISPLAY to adjust the amount of time you want the sauna to remain on. Press the C/F button to choose between Celsius and Fahrenheit. Press the up/down arrows under the TEMPERATURE DISPLAY to adjust the temperature setting. Once you have set these adjustments to the desired settings, press the START/WORK button. If you do not press the button for 5 seconds, the control panel will stop flashing and the set-up values will be memorized. The WORK and HEAT lights will now be on and the emitters will now be generating heat. You can either pre-heat the sauna to the set temperature before entering or sit inside the sauna as the temperature rises to the set temperature. Please keep in mind that you will increase the time it takes for the sauna to reach the set temperature if you enter the sauna room before it has reached the set temperature.
4. During your sauna session, set-up time will count down the minutes one by one.

You can use the up/down arrows to adjust the time. If you do choose to adjust the time, the control panel will flash and the emitters will stop generating heat. Once you set the time to the desired setting, then press the START/WORK button twice and the control panel will stop flashing and heat will began coming from the emitters once again.

5. Heating times do vary. Generally, it will take approximately twenty to thirty minutes to preheat the sauna to the average used temperature range of approximately 118 degrees Fahrenheit / 48 degrees Celsius. When the ambient temperature is low, heating requires additional time. For the first few times of use, you may use 115 degrees Fahrenheit / 46 degrees Celsius as a reference starting point for a time period of about 20 to 30 minutes (this represents the actual time you are in the sauna at the desired temperature). As you become more comfortable and familiar with the sauna, you can increase the temperature and time period according to your personal preference.
6. When the temperature is at the set-up value, the digital control will maintain the set temperature. The WORK light will remain on and the HEAT light will turn off. The emitters will stop generating heat. Once the inside temperature drops approximately 4 degrees Fahrenheit, the HEAT light will turn back on and heat will again be generated by the emitters. With the digital control, the inside temperature will always remain around the set-up value.
7. Reading lamps and/or roof lamps and/or color therapy lamps are operated by pressing the respective buttons located towards the center of the control panel. These lamps are offered on some models and are not available on all models.
8. **Color Lighting** can be operated as follows: First, you will need to install the battery. Once the battery has been inserted into the remote, you are ready to operate the color therapy lighting system . Press the READING LIGHT button on the sauna control panel. The white light will come on. While pointing the remote at the ceiling light, you can press any of the colors on the remote and that color will be displayed. You can use the SHADE button on the remote to go through a sequence of colors. If you want to turn the light off during your sauna session, you can press the POWER button on the remote. **Please note: You must be inside the sauna room for the remote to work.**



9. **Bluetooth** can be used on the radio. Please see the Owner's Manual for the radio to connect your Bluetooth device.

10. **Please Note: On average, it takes our model saunas approximately:**
- \*20 minutes to reach into 100 degrees Fahrenheit/38 degrees Celsius (with a Starting temperature above 70 degrees Fahrenheit/21 degrees Celsius)**
  - \*25-30 mins to reach about 115-120 degrees Fahrenheit/46-49 degrees Celsius (depending on sauna model)**
  - \*35-40 minutes to reach about 125-130 degrees Fahrenheit/52-54 degrees Celsius (depending on sauna model)**
  - \*45-60 minutes to reach up to approximately 135 degrees Fahrenheit/57 degrees Celsius (depending on sauna model)**

**Please keep in mind that you can either preheat the sauna to the set temperature before entering or sit inside the sauna as the temperature rises. In addition, you will increase the time it takes for the sauna to reach the set temperature if you enter the sauna room before it has reached the set temperature. Also, the most commonly used temperature setting is between 118 degrees Fahrenheit / 48 degrees Celsius and 122 degrees Fahrenheit / 50 degrees Celsius. The way the sauna room works is when you set the Control Panel to say 120 degrees F / 49 degrees C, the heat emitters will turn off when that set temperature is reached.**

**And even though the sauna does allow the user to set the Control Panel to 151 degrees F/66 degrees C, this is specifically for those users who do not want the heat emitters to ever turn off as the sauna room will never achieve 151 degrees F / 66 degrees C. After 3 hours of continuous use, the sauna needs to be shut down for one hour.**

## **Tips for using Your Sauna**

1. If you take a hot/warm shower or bath before using your sauna, you may perspire more and experience more comfort.
2. Drink water prior to, during, and after your sauna session to replenish body fluids.
3. To regulate the set temperature inside the sauna to your comfort level, use the movable roof vent or leave the door slightly open. The roof vent is installed on the sauna and used based on personal preference.
4. Use 2 towels during your sauna session. Fold the first towel several times and place it on the bench. As you sit on this towel, it will absorb a majority of your perspiration while adding comfort as you sit on the bench. Use the second towel to either constantly wipe the perspiration from your body to perspire faster and also to avoid having too much perspiration dripping onto the floor. Never place any towels over the floor heater. If your legs become cold, you can use a third towel to drape over your legs to trap the heat.
5. This is a non-commercial sauna. For every three hours ON, the sauna must be turned OFF for one hour to cool down.
6. At the first sign of a cold or flu, increasing your sauna sessions may be beneficial

in boosting your immune system and decreasing the reproductive rate of the virus.

7. To help relieve sore and tense muscles, massage the affected areas during your sauna session.
8. To treat your ankles and feet more effectively, you can elevate them and move them close to one of the heat emitters to achieve a deep heating effect.
9. To utilize the sauna's heat therapy effect, put oil and treatment into your hair and wrap it with a towel. After your sauna session is over, rinse your hair thoroughly.
10. The peaceful and relaxed state rendered by a sauna session may help you to sleep easier and deeper.
11. To conserve energy consumption, please unplug your sauna when not in use – especially if you do not plan on using the sauna for an extended period of time.
12. After the sauna session is over, do not jump into the shower or bath immediately. Because your body was heated up during the sauna session, it will continue to perspire even after the heat emitters are off. Sit in the sauna with the door slightly opened and let your body cool down. Once your body has cooled down and you feel comfortable, you can exit the sauna. After about fifteen minutes and when your body has completely cooled down, you can take a shower or bath to clean your body.

## Safety Instructions

1. Read and follow all instructions carefully before using the sauna.
2. When assembling and using the electrical equipment, safety precautions should always be followed.
3. To reduce the risk of injury, do not allow children to use the sauna unless they are closely supervised at all times by an adult. Children should not use the sauna unless prescribed or advised by their medical doctor.
4. Do not use the sauna immediately following strenuous exercises. Wait at least 30 minutes to allow the body to cool down completely.
5. Pregnant or possibly pregnant women should contact their medical physician prior to using the sauna. Excessive temperatures have a high potential for causing fetal harm during pregnancy.
6. **Hyperthermia Danger:** The normal body temperature can't rise above 103°F (39°C). Symptoms of excessive hyperthermia include dizziness, lethargy, drowsiness, and/or fainting. The effects of excessive hyperthermia may include, but are not limited to failure to perceive heat, physical inability to exit the sauna, unawareness of impending hazards, unconsciousness, and/or fetal harm in pregnant women. Hyperthermia could make your body's core temperature rise. Setting the desired temperature to an excessively high temperature is not recommended.
7. The use of alcohol, drugs, or medications (prescribed or non-prescribed) prior to or during the sauna session may lead to unconsciousness and/or other harmful physical injuries.



8. Persons suffering from obesity or with a medical history of heart disease, low or high blood pressure, circulatory system problems, diabetes, or other medical conditions should consult with a medical physician prior to using the sauna.
9. Persons using medications should consult with a medical physician before using the sauna. Some medications may induce drowsiness while other may affect the heart rate, blood pressure, and/or blood circulation.
10. Use care when exercising before and after sauna use.
11. Never sleep inside the sauna
12. Do not use any type of cleaning agents on the interior of the sauna. Only wipe down the sauna room with water and a damp cloth. Never use any chemical based cleaners.
13. Do not stack or store any objects on top of or inside the sauna.
14. If the power supply cord becomes damaged, it must be replaced immediately by the manufacturer or its agent. If you find the power cord is too hot (normally it will become warm) or that the electrical equipment may be experiencing technical problems, please contact the manufacturer or its agent immediately to avoid hazardous situations.
15. Make sure that the electrical outlet is in good working order. A common problem with electrical outlets is loose wiring on the connection points of the terminals of the outlet. A loose wire will also make for a bad connection and cause an unusual amount of heat buildup. Loose connections can also cause sparking in the junction box that can result in arcing. You'll likely see burn marks around the terminals if this occurs. If this happens, do not use the sauna and have the outlet replaced by a certified electrician. If the power cord is damaged, please contact Customer Support.
16. Do not use the sauna during an electrical storm to avoid risk of shock or injury.
17. Do not continuously switch the power ON and OFF excessively as it will compromise the life of the electrical components.
18. Your hands must be dry and free of moisture before plugging and unplugging cords and wiring harnesses from the power supply and circuit boards. Never operate the sauna with wet hands or wet feet to avoid the risk of electrical shock or injury. Never touch the metal prongs of the plug.
19. Do not attempt to make any repairs yourself unless authorized by the manufacturer or its agent. If a problem occurs with the sauna, please contact the manufacturer or its agent immediately to avoid safety risks. Unauthorized repair attempts will void the manufacturer's warranty.
20. Please make sure the outlet power supply meets the specifications required. Failure to meet the requirements may cause safety risks.
21. Some sauna models are equipped with reading and/or roof lamps. Because the lamp temperature will become very hot once powered ON, do not attempt to touch the lamp to avoid being burned. Do not attempt to touch it for at least 20 minutes or until it cools down completely if a need to touch it arises.
22. Do not pour water or any other liquids onto the infrared heat emitters. Do not bump, hit, or break the heating elements as it may cause an electrical short and pose a safety risk.
23. Do not make any modifications to the sauna, the sauna structure, or the sauna components.
24. Prior to each sauna session, the sauna room is to be inspected for correct

operation. If for any reason your sauna does not seem to be operating properly, discontinue use and contact Customer Service.

## Safeguards For Your Sauna

1. Do not install the sauna near water, near a bathtub (if water will splash on the sauna), near a shower (if water will splash on the sauna), in a wet basement, or near a swimming pool (if water will splash on the sauna).
2. Do not use liquid cleaners or aerosol cleaners on the sauna. Unplug the sauna from the wall outlet before cleaning. Use plain water and a soft damp cloth for cleaning.
3. The power supply cord should be routed so that it is not walked on or pinched by any object that may be placed against it.
4. When replacement parts are required, be sure they meet the specified requirements of the manufacturer. Unauthorized substitutes may result in a fire, electrical shock, or other hazardous situations. After any repairs, please ask the service technician to perform a safety check to determine that the sauna is in good working order.
5. Do not use any wall receptacle adapter, surge protector, or extension cord between the sauna cord and wall outlet.

## Troubleshooting

**Before any troubleshooting of the sauna, make sure to unplug the sauna's power cord from the wall outlet. If the sauna is hard wired straight to the breaker in the Electric Panel, turn the breaker to the "OFF" position.**

### 1. Cannot Locate the Owner's Manual

**Solution:** The Owner's Manual is included in the Accessory Box. The accessory box is located in the roof panel. Please remove the thin hardboard roof cover to gain access to the Accessory Box.

### 2. Assembly

**Solution:** We do have an assembly video on youtube.com. The video may not be of the particular model you purchased, but our saunas do assemble in a similar fashion. Here is the web address to the video:  
<https://www.youtube.com/watch?v=2p-ib6Mwnoc>

### 3. No Heat Coming From Some of the Heat Emitters

**Solution:** Check to make sure all the heat emitter cords are properly

connected, including the cord to the heat emitter underneath the bench (if applicable). Go to the roof, and also check that the heat emitter cords are properly connected snug and tight to the cords on the roof and that those cords are properly plugged into the power supply (snug and tight).

**Solution:** If some of the heat emitters are working, then the ones which are not working may have been damaged or are not properly connected. Check that the heat emitter cords are properly connected snug and tight. If the issue continues, then the particular heat emitter may be damaged. Do not continue to operate. Contact the manufacturer for replacement parts.

**Solution:** If the heat emitters are not working and there is a “-L” for the temperature reading, then the temperature sensor may not be plugged in properly or it may be damaged or the power supply may be defective. Go up to the rooftop of the sauna and locate the temperature sensor connection wires near the air vent towards the rear of the sauna. After you have located the wires labeled “TEMP SENSOR”, disconnect the connection and reconnect the connection. If you have a second person available, please have them continue to look at the control panel as you disconnect and reconnect the temperature sensor connection to see if the “-L” changes at any time. If the “-L” disappears and reappears, then there may be an issue with the connection. Please contact Customer Service for assistance.

#### 4. Control Panel Malfunctioning

**Solution:** If the control panel is showing no signs of power, then there could be a connection issue of the “CTRL” harness up on the roof. Go up to the roof and locate the “CTRL” wire harness you connected when the roof was installed onto the sauna room. Disconnect the “CTRL” wire harness and firmly reconnect the “CTRL” wire harness making sure it is snug and tight. Attempt to turn the sauna on at the control panel and check to see if the buttons are now responding. Contact the Customer Service for any additional troubleshooting.

**Solution:** If the control panel is showing no signs of power, then there could be a connection issue of the “CTRL” harness behind the control panel. You will need to remove the wood frame holding the control panel in place to gain access to the “CTRL” connection behind the control panel. Once you remove the control panel from the wall panel, you can disconnect and reconnect the connection making sure it is snug and tight.

**Solution:** If the control panel is showing no signs of power, check the sauna power cord at the wall outlet to make sure it is plugged in snug and tight. Also check your main circuit breaker to confirm that it has not tripped. Check the power supply on the roof of the sauna to make sure there are no signs of malfunctioning, such as a high temperature, burning odor, or strange sounds. Also, check to make sure none of the power

cords are damaged. If the power supply is malfunctioning or power cords are damaged, then unplug the sauna immediately and contact the Customer Service.

**Solution:** The control panel will not turn off, the power/work/or heat lights do not come on, or the temperature and timer buttons do not work means the control panel may have been damaged and will need to be replaced. Before contacting Customer Service, remove the wood frame holding the control panel in place to gain access to the "CTRL" connection behind the control panel. Once you remove the control panel from the wall panel, you can disconnect and reconnect the connection making sure it is snug and tight.

Contact Customer Service for any additional troubleshooting.

**Solution:** If your sauna is plugged in and you have no power at the control

panel, then the power supply may need to be reset. Go to the roof of the sauna and locate the power supply. Press the RESET button to reset the power supply. The RESET button is on the same side of the power supply as the power cord. Attempt to turn the sauna ON at the control panel.

Contact the manufacturer for any additional troubleshooting if necessary.

**Solution:** There could be damage to the temperature sensor. If your sauna arrived with a spare temperature sensor, turn the control panel off and go to the roof of the sauna and locate the red and black wire near the air vent

towards the rear of the sauna. After you have located the red and black wires labeled "TEMP SENSOR", disconnect them. Connect the spare temperature sensor. For testing purposes, insert the "TEMP SENSOR" (you just connected) down the vent on the roof so that it is now inside the sauna. Then go to the control panel and press the power button. If the heat emitters now heat, then the temperature sensor was the cause of the problem. You may have to wait about five minutes to confirm if the heat emitters are generating heat. Remove the original temperature sensor from its hole and replace it with the spare one.

**Solution:** If your control panel displays "-L", it may be an error code and we assume both control panels are displaying this. If so, then it means there is a communication issue between the control panel, power supply, and temperature sensor. Please proceed to the following:

**Step A:**

1. Reconnect the sauna's power cord. Make sure the control panel is turned ON. Two individuals will be needed. One individual will continuously watch the "-L" on the control panel to see if it changes while a second person goes up to the roof and locate the "PANEL CONTROL" harness connection that was connected during the assembling of the

sauna room. Check both ends of this connection including at the power supply box.

2. Disconnect the "PANEL CONTROL" harnesses (both ends) and then reconnect making sure that the connection is snug and tight.

3. Also and while up on the roof, please located the temperature sensor wire. The temperature sensor is the black probe that is sticking out of the interior ceiling above your head as you sit on the bench. Disconnect the connection and reconnect to make sure the connection is snug and tight.

4. The individual watching the control panel can let you know if the "-L" ever changed. If the "-L" is still displayed on the control panel, then we need to rule out a control panel issue. Please proceed to **Step B**.

### **Step B:**

1. Make sure to first unplug the sauna's power cord from the wall outlet or power source. If the sauna is hard wired straight to the breaker in the Electric Panel, turn the breaker to the "OFF" position.

2. Remove the exterior wood frame around the exterior control panel. Simply unscrew the screws holding the wood frame on.

3. Once the wood frame has been removed, lift the control panel up and out. On the backside of the control panel, you will see a connection plug. This connection plug needs to be removed. In some cases, there is a plastic tie that holds the connection plug in place during shipment. This tie will have to be cut before the connection plug can be unplugged. You do not need to replace this tie. There are several connections, but you only have to be concerned with the black connection. You want to unplug by pulling the male connection from the female connection. Reconnect to make sure the

connection is snug and tight. Leave the control panel hanging from the wall panel (do not replace with the wood frame as of yet).

4. Next, you can plug the sauna room back into the wall outlet or turn the breaker back "ON". Test the control panel to see if it is responding and working properly or if the "-L" is still displayed. If the control panel is responding and working properly, then it was a connection issue causing the problem and you can put back the control panel and wood frame.

**Solution:** Unfortunately, our saunas cannot be connected to a GFCI due to the amount of power the sauna uses. We have had customers who have connected their sauna to a GFCI protected outlet for the first time or for many months and then all of a sudden the GFCI starts causing the sauna to trip or just not turn ON at all. We do not have an answer as to why the GFCI was fine in the beginning when supplying power to the sauna and then suddenly starts causing problems for the sauna power supply. We recommended not connecting the sauna power cord to a GFCI protected outlet.

## **5. Wall Outlet Melting**

**Solution:** A common problem with wall outlets is loose wiring on the connection points of the terminals of the receptacle. A loose wire will also

make for a bad connection and cause an unusual amount of heat buildup. Loose connections can also cause sparking in the junction box that can result in arcing. You'll likely see burn marks around the terminals if this happens. You will need to consult with an electrician to replace the wall outlet. You will need to contact Customer Service if the power supply cord is damaged as the power supply will need to be replaced.

## 6. Bluetooth

**Solution:** Please note that you can only have a single device connected to the Bluetooth at any given time. You must unpair your device before connecting with another device. To do a master reset of the Bluetooth, you will need to unplug the sauna power cord from the wall outlet for 15 minutes.

## 7. Speaker Noise

**Solution:** If you are hearing a humming noise from either speaker or both speakers while the Bluetooth feature is connected with your musical device, then there may be an issue with the control panel(s). To confirm this, please connect your musical device using the MP3 AUX wire that came with the sauna room to connect your musical device to the sauna speaker system. You will connect one end of the MP3 AUX wire to your musical device and the other end to the MP3 Jack on the ceiling. If the humming sound can no longer be heard, then this confirms that the control panel(s) will need to be replaced. Please contact Customer Service.

**Solution:** If you hear static noises from the speakers when no music is playing, then be sure that the MP3 AUX wire is not plugged into the ceiling port. You will have a constant noise coming from the speakers if one end of the MP3 AUX wire is connected to the ceiling port and the other end is not connected to anything.

## 8. Color Lighting

**Solution:** If your color light is not working, the issue with the light may have to do with the connection on the top side of the light fixture. Please go up to the roof panel and disconnect the wire connection on the top side of the light fixture. Then reconnect the wire connection making sure that it is snug and tight. Return back to the sauna control panel to test the light. If the light is still having issues, please contact our Customer Service.

## 9. Dedicated Power Outlet

**Solution:** You have two options when it comes to a dedicated receptacle. You have a true dedicated line if the receptacle is the only receptacle on the line to the breaker in your electric panel box. You have a quasi-dedicated line if you have multiple receptacles on a line to the breaker in your electric panel box and you do not draw any power from the other receptacles when the sauna is in operation. Both of these options are acceptable.

## 10. Lower Heat Emitters

**Solution:** With regards to the lower heat emitters under the bench and on the floor, these heat emitters operate a bit different than the wall heat emitters. As the bench heat emitter and floor heat emitter (200W/125W each) are of much less wattage than the wall heat emitters (300W each), they will not get nearly as hot as the wall heat emitter panels. We can have you run two tests. First, remove the bench from the sauna room. Next, preheat the sauna room by setting the temperature to the maximum of 151 degrees F and time to 90 minutes. Record the starting/beginning temperature and the temperature after 15 minute intervals up to 90 minutes (do not enter the unit or open the door during this test). If the sauna room goes above 130 degrees F (usually after about 40 to 50 minutes of preheating with a beginning temperature above 70 degrees F) at any given time, then we know that the heat emitters are working successfully. With even one heat emitter not working correctly, the sauna room will struggle to get above 130 degrees F within the average allotted time. The next test would be to enter the sauna room and to **cautiously** place your hand on the back side of the bench heat emitter in the center (this would normally be covered by the bench which you already removed). If you touch the heat emitter panel and it is warm-to-hot, then it is working correctly. If you are able to place your hand on the back side of the heat emitter and it feels like there is no heat being produced, then we know it is not working properly and you will need to contact Customer Service. You can also check the floor heat emitter by touching the heat emitter **cautiously** with your finger. You will need to remove the wood grade cover to get a true feeling of the heat from the floor heat emitter. Please do keep in mind that the bench heat emitter and floor heat emitter only keep the area below the bench warm as heat always rises. The majority of heat is concentrated above the bench. You

can use a towel to drape over your legs to trap the heat as it rises if your lower extremities feel a draft.

#### **11. Intentional Rear Wall Warp**

**Solution:** The rear wall panel is intentionally warped as part of the sauna design. This adds strength to the sauna structure once the unit is assembled. Please try the following in assembling the sauna. With one person inside the sauna room and pushing on the rear wall panel outward, a second person should be able to latch the buckles. Make sure that the wall is fitting together like a puzzle as one wall panel fits into the other. Work your way down from top to bottom.

#### **12. Too Much Perspiration On The Floor Heater**

**Solution:** Use 2 towels during your sauna session. Fold the first towel several times and place it on the bench. As you sit on this towel, it will absorb a majority of your perspiration while adding comfort as you sit on the bench. Use the second towel to constantly wipe the perspiration from your body to perspire faster and also to avoid having too much perspiration dripping onto the floor heater. Never place any towels over the floor heater.



## Limited Lifetime Warranty

**7 Year Limited Warranty:** Golden Designs, Inc. under the Dynamic brand name and other brand names warrants the wood, structure, heating elements, and electronics against defects in material and workmanship for a period of 1 to 5 years from the original date of purchase. **This sauna is for INDOOR use only. Placing your sauna outdoors will VOID this warranty. Any damage due to exposure to outdoor elements such as rain, snow, sun, wind or extreme temperatures will not be covered by this warranty. Any damages as a result of modifications made to the sauna or its components will void this warranty.**

**Extent of Warranty:** This limited warranty applies to products manufactured or distributed by Golden Designs, Inc. under the Dynamic brand name, delivered in the continental United States or Canada and extends to the original purchaser at the original site of installation only. This warranty becomes valid at time of purchase and terminates either by specified time frame listed above, owner transfer, or relocation. **Your sales receipt showing the date of purchase of the product is your proof of purchase. Warranty is not transferable.**

### Manufacturer Warranty

All Golden Designs, Inc. products are manufactured with the highest quality appliances and are warranted to be free from defects in material and workmanship at the time of delivery. The appliance warranty is extended through the manufacturer for the product including, but not limited to: stereos, CD/DVD players, etc. All exchanged parts and products replaced under this warranty will become the property of Golden Designs, Inc. Golden Designs, Inc. reserves the right to change manufactures of any part to cover any existing warranty. Any parts determined to be defective must be returned to Golden Designs, Inc. to obtain warranty service. You must prepay any shipping charges, export taxes, custom duties and taxes, or any other charges associated with the transportation of the parts. In addition you are responsible for insuring any parts shipped or returned. You must present Golden Designs, Inc. with proof of purchase documents (including the date of purchase). Any evidence of alteration, erasing or forgery of proof of purchase documents will be cause to **VOID** this limited warranty. Products on which the serial number has been defaced or removed is not eligible for warranty service. This warranty covers parts, but does not cover labor.

### Warranty Limitations

This warranty does not apply if the unit has been subject to full commercial use, negligence, alteration, modification, misuse, abuse, repairs by non-Golden Designs, Inc. authorized personnel, inappropriate installations, or any case beyond the control of Golden Designs, Inc. invalidating this warranty including but are not limited to:

- Use of lacquer or paints
- Sauna and other Golden Designs, Inc. products accessories placed on non- approved surfaces
- Outdoor applications

- Normal wear and tear or weathering
- Use of product not in accordance with instructions
- Worn out receptacle

**Surface cracks are not considered defects in material or workmanship, as they are normal characteristics of all woods. This includes minor cracks due to wood expansion and contraction. Note: Since the wood used in construction has been kiln dried, a certain amount of expansion and contraction occurs in the wood in a sauna environment.**

### **Disclaimers**

Golden Designs, Inc. shall not be liable for loss of use of sauna or other Golden Designs, Inc. products or other secondary or incidental or consequential costs, expense or damages - which may include the removal of permanent deck or other custom fixtures or the necessity for crane removal - arising directly or indirectly out of the use or inability to use the product. Any implied warranty shall have duration equal of the applicable warranty stated above. Under no circumstances shall Golden Designs, Inc. or any of its representatives be held liable for injury to any person or damage to any property, however arising. Specifications are subject to change without notice or obligation.

### **Legal Remedies**

This limited warranty gives you specific legal rights. You may have other rights, which may vary from state to state.

### **Customer Service**

For customer service, contact your authorized dealer.

\*Limited Lifetime Warranty of Sauna Products is 7 years on heating elements and electronics from the date of purchase. The radio and wood structure have a 1 year limited warranty.

**WARRANTY CARD**

Congratulations on your purchase of an Infrared Sauna from Golden Designs, Inc. Please take the time to complete the following Warranty Card and mail it back to:

text or call us toll-free: 800-614-7411  
send us an email: support@usbathstore.com

Please include a copy of your sales receipt showing date of purchase as this will serve as proof of purchase.

**Warranty will be VOID if the following warranty card is not mailed back within 60 days of purchase date along with proof of purchase.**

**\*\*Serial number (S/N) is located on the sauna’s front panel, rear panel, or on the carton.\*\***

DETACH HERE



**WARRANTY CARD**

All fields must be completed to validate the

warranty. Name: \_\_\_\_\_

Address: \_\_\_\_\_

City: \_\_\_\_\_ State: \_\_\_\_\_ Zip Code: \_\_\_\_\_

Phone Number: \_\_\_\_\_

Purchase Date: \_\_\_\_\_

Purchase From: \_\_\_\_\_

Serial Number: \_\_\_\_\_