



Rasmussen[®]
THE GAS LOG COMPANY

ALTERNA™ YELLOW FLAME
DECORATIVE VENTED GAS LOG SET (Controls)
General Assembly, Installation, and Operation Instructions



12028 E. PHILADELPHIA ST.
WHITTIER, CA CALIFORNIA 90601 U.S.A.
www.rasmussen.biz

Alterna TM YFZ 0812

ATTENTION! READ INSTRUCTIONS CAREFULLY BEFORE ASSEMBLY OR USE

Models: "Alterna YellowFlame"; FGV/ FDV / FLB 18,24,30 or 36;-Z18, 24,30 or 36; ME(Manual Control), S(Millivolt),SE (Remote ready), or RE (Variable Flame Height Remote),VEI (Electronic Ignition),VMV (Millivolt) - Natural Gas or Propane

Available with the following FireGlitter and FireDrops

FireGlitter: Blue-Green (BG), Black (BL), Cobalt Blue (CB), Copper (CU), Platinum (PL)

FireDrops: Aqua-Blue (AB), Black (BL), Emerald Green (EG), Honey-Yellow (HY), Platinum (PL), Fire Red (FR)

WARNING: If the information in this manual is not followed exactly, a fire or explosion may result causing property damage, personal injury or loss of life.

- Do not store or use gasoline or other flammable vapors and liquids in the vicinity of this or any other appliance.
- **WHAT TO DO IF YOU SMELL GAS**
 - Do not try to light any appliance.
 - Do not touch any electrical switch; do not use any phone in your building.
 - Immediately call your gas supplier from a neighbor's phone. Follow the gas supplier's instructions.
 - If you cannot reach your gas supplier, call the fire department.
- Installation and service must be performed by a qualified installer, service agency or the gas supplier.

INSTALLER: Leave this manual with the appliance.
CONSUMER: Retain this manual for future reference.

Improper installation, alteration, service or maintenance can cause property damage, personal injury or loss of life. Read these instructions thoroughly before installation. For assistance or additional information, consult your gas log dealer, qualified installer, service agency or gas supplier.

This appliance may be installed in an aftermarket, permanently located, manufactured (mobile) home, where not prohibited by local codes.

This appliance is only for use with type of gas indicated on the rating plate.

Installation must conform with local codes or, in the absence of local codes, with the National Fuel Gas Code, ANSI Z223.1/NFPA 54.

In the Commonwealth of Massachusetts:

- Installation must be performed by a licensed plumber or gas fitter.
- The chimney flue damper, when used with gas logs, will be welded open or completely removed.
- A CO detector shall be installed in the room where the appliance is installed.

WARNING

This is a vented gas appliance for use only in a solid-fuel burning fireplace constructed on non-combustible material with a fully functional chimney flue which must vent all of the products of combustion.
WHEN OPERATING, THE CHIMNEY DAMPER MUST BE FULLY OPEN

MINIMUM FIREPLACE FLUE REQUIREMENTS

The minimum permanent chimney or damper opening is the minimum permanent free opening required by Standards or Codes to ensure safe operation of the appliance and must be at least 39 square inches for 18"-20" models, 51 square inches on 24" models and 64" on 30" models based on a minimum chimney height of 10 feet. It is **NOT** the minimum operating damper position, which should be **wide open** when burning.

Yellow Flame Contemporary Gas Heaters are certified to the following standards:
VENTED DECORATIVE APPLIANCE - ANSI Z21.60-2009, CSA 2.26b-2009

IMPORTANT INFORMATION

- **Due to high temperatures**, the appliance should be located out of traffic and away from furniture and draperies.
- **Children and adults** should be alerted to the hazard of high surface temperatures and should stay away to avoid burns or clothing ignition.
- **Young children** should be carefully supervised when they are in the same room with the appliance.
- **Do not place** clothing or other flammable material on or near the appliance.
- **Any safety screen** or guard removed for servicing an appliance must be replaced prior to operating the appliance.
- **Installation and repair** should be done by a qualified service person. The appliance should be inspected before use and at least annually by a professional service person. More frequent cleaning may be required due to excessive lint from carpeting, bedding material etc. It is imperative that control compartments, burners and circulating air passageways of the appliance be kept clean.
- **WARNING:** Any change to this appliance or its controls can be dangerous.
- **WARNING:** Failure to keep the primary air opening(s) of the burner clean may result in sooting and property damage.
- **Keep appliance area** clear and free from combustible materials, gasoline and other flammable vapors and liquids.
- **DO NOT** use this room appliance if any part has been under water. Immediately call a qualified service technician to inspect the appliance and to replace any part of the control system and any gas control that has been under water.
- **WARNING:** Before installing in a solid-fuel burning fireplace, the chimney flue and firebox must be cleaned of soot, creosote, ashes and loose paint by a qualified chimney cleaner.
- **WARNING:** Do not allow fans to blow directly into the fireplace. Avoid any drafts that alter burner flame patterns.
- **WARNING:** Do not use a blower insert, heat exchanger insert or any other accessory not approved for use with this heater.
- **A fireplace screen** must be in place when the appliance is operating and, unless other provisions for combustion air are provided, the screen shall have an opening(s) for introduction of combustion air.
- **Solid fuels** shall not be burned in a fireplace where this appliance is installed.
- **WARNING:** Glass doors must be fully opened when appliance is in operation to allow for safe combustion, cooling of components and venting.
- **Any outside air ducts** and/or ash dumps in the fireplace shall be permanently closed at the time of appliance installation.
- This appliance may be used in sleeping quarters and bathrooms if used in a vented application, subject to local codes.
- **Avoid contact** with the objects, chassis or another part which may be hot during operation.

Your gas log is assembled at the factory to be installed in a fireplace plumbed with the gas supply on the right side (facing unit). DO NOT convert to the left side of burner. Instead, run connecting pipe or aluminum flex connector (per local codes) behind burner along the back wall of fireplace bringing your gas line to the right side.

CARBON MONOXIDE POISONING MAY LEAD TO DEATH

When used without fresh air, decorative gas appliances may give off carbon monoxide, an odorless, colorless, poisonous gas. Some people, pregnant women, persons with heart or lung disease, anemia, persons under the influence of alcohol and persons who live at high altitudes are more affected by carbon monoxide than others.

Early signs of carbon monoxide poisoning resemble the flu and include; headache, dizziness and/or nausea. If you have these symptoms, the burner or the appliance may not be installed or working properly, or the flue may be blocked. **GET FRESH AIR AT ONCE!** Verify that the gas log set is properly arranged and have the heater and chimney flue serviced before using again.

WARNING

During manufacturing, assembly and packaging, various components of this appliance are exposed to certain oils or films. These are not harmful but may produce annoying smoke and smells as they are burned off during the initial operation of the appliance, possibly causing headaches, eye or lung irritation. This is a normal occurrence and only temporary. The initial break-in operation should last 2-3 hours with the burner at the highest setting. Provide maximum ventilation by opening windows, doors and the chimney flue (if using a vented model) to allow odors to dissipate. The only odor remaining after this initial break-in period will be the normal odors associated with the combustion of Natural or Propane Gas and/or related to your indoor environment (see page 12).

WARNING—Proposition 65 Statement

If not installed, operated and maintained in accordance with these instructions, this product could expose you to substances in fuel or from fuel combustion which are known to the State of California to cause cancer, birth defects or other reproductive harm.

PARTS LIST

REQUIRED TOOLS AND MATERIALS

Adjustable Wrench and Pipe Wrench. Pipe Sealing compound is **required** if fittings not already pre-threaded with Teflon tape to prevent gas leaks. **DO NOT** use Teflon tape or pipe compound on other tapered fittings.

- | | | |
|--|---|--|
| 1. Rating/I.D. Plate (Chained to Burner assembly) | 12. Valve Knob Extender for Manual "EASY" Safety Valve (STV-KE2) | 18. Hand held variable remote for "-RE" models (STR-RMD) |
| 2. Valve Vanisher (18, 24, 30) (B or SS) | 13. Pilot / Thermocouple for Natural / Propane (ODS-C-N/P) | 19. Pilot thermogenerator for Models "S/VMV" (JPG9- N/P) |
| 3. Burner Pan (RD18, 24, 30 & 36)(B or SS) | 14. Pilot Bracket (PB1) | 20. Millivolt valve for Models: "S/VMV" (V11Z-NG/P) |
| 4. Orifice Size Chart | 15. Flex Connector (SSCB-14) | 21. Bag of FireGlitter or FireDrops (GLX-??/FDX-??) Pan Medium included: 15lbs (18"), 25lbs (24"), 35lbs (30") and 45lbs (36") |
| 5. Battery Holder (For model number: FGV/FD/FLB-18/24/30-VEI-N/P) | 16. Pilot Assembly (J95R-N/P) | 22. Wireless Remote Transmitter Devices For "-SE" Models (each sold separately) |
| 6. 3/8" x 1/2" FIP Flared Brass Fitting (A1) | 17A. Manual "EASY" Safety Valve (-ME) (STV-10) with R-1 Regulator | A. Wireless On/Off Remote (SR-2R) |
| 7. Orifice Spud (see chart for size) | 17B. Remote Ready "EASY" Safety Valve (-SE) (STV-LS) with R-1 Regulator | B. Wireless On/Off Remote with Thermostat (THR-2R) |
| 8. Orifice Holder (Internally Tapped 3/8" x 3/8" Flared MIP Fitting) (A2T) | 17C. Variable Flame Height "EASY" Safety Valve (-RE) (STR-VMD) with R-1 Regulator | C. Wireless Wall Thermostat (TS-2R) |
| 9a. Air Mixer for Propane Gas burners (MA2) | | D. Wireless Wall Switch (WS-2R) |
| 9b. Reducing Coupling (Natural Gas) | | E. Wireless Wall Timer (30/60/120 Minutes) (WT-2R) |
| 10. Damper Clamp (DC1) | | 23. Receiver for "-SE" or "-RE" (BPR3) |
| 11. Log Lifters (LL) 2(LL) for 18", 3(LL) for 24", 4(LL) for 30" and 5(LL) for 36" | | |

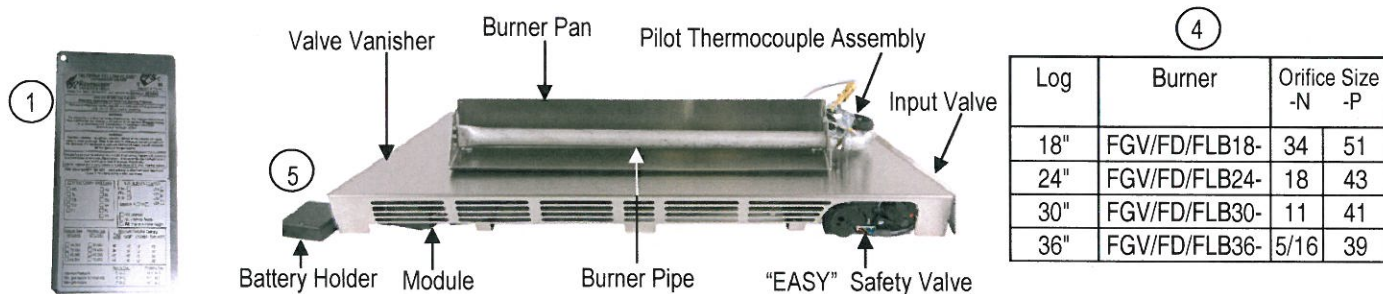

PART LIST CONT. AND ACCESSORIES OPTIONS FOR "MILLIVOLT" SAFETY VALVE

- 24. Heat Shield (HYFZ)
- 25. "RD" Burner pan sold when purchase with Models:ME/SE/RE/S series.
- 26. Toggle switch (SW-1; replacement switch with wires only)
- 27. Hand Held Remote system (Optional; not sold with burner. (SR-MV1)
- 28. Wireless "On/Off" remote control with thermostatic and countdown timer features. (THR-MV1)
- 29. Remote House for Remote Receiver (RH2)
- 30. 60 minutes Wall Timer (WT-1)(20' wire and cover included)
- 31. Wall Switch, Cover and 20" wire (WS-1)
- 32. Wall Thermostat Control (TS-1)(20' wire included)

Note: These parts below are for Model "VEI"

- 33. GV60 Electronic Ignition Gas Valve
GV60-VNG(Natural gas) (GV60-VLP(Propane)
- 34. Remote / Transmitter, Variable Height Control (GV60-TXB)
- 35. Module / Receiver(GV60-RXA)
- 36. Interrupter Block(GV60-TIA)
- 37. Ignition Cable (GV60-ICA)
- 38. Interruptor Receiver Cable (GV60-RCA)
- 39. On / Off Switch Cable (GV60-SWA)
- 40. 8 Wire Cable (GV60-C8)
- 41. GV60 Battery Box / Cable (GV60-BCA)

Note: 27. thru 32. (Optional Accessory; not sold with burner.)



GENERAL INSTALLATION INSTRUCTIONS

WARNING: Failure to position the parts in accordance with these diagrams or failure to use only parts specifically approved with this appliance may result in property damage or personal injury.

The appliance and its appliance main gas valve must be disconnected from the gas supply piping system during any pressure testing of that system at test pressures in excess of 1/2 psi. The appliance must be isolated from the gas piping system by closing its equipment shutoff valve during any pressure testing of the gas supply piping system at test pressures equal to or less than 1/2 psi.

Natural Gas Operating Pressures: Minimum inlet gas supply pressure = 6 inches of water column. Maximum inlet gas supply pressure is 7 inches of water column. **Propane Gas Operating Pressures:** Minimum inlet gas supply pressure = 11 inches of water column. The maximum inlet gas supply pressure is 14 inches of water column.

STEP ONE PREPARATION:

1. Verify that the Valve Assembly is correctly matched to the log set, burner, and gas supply.
2. Turn off **Fireplace Gas Supply** (Figure 1A).
3. Thoroughly clean fireplace floor of any ashes and have a qualified chimney cleaner insure that the chimney flue and firebox are free of soot, creosote, and loose paint.
4. Attach **Damper Clamp** (Figure 2A) over edge of fireplace **Damper Blade** (Figure 2B) to prevent damper from fully closing accidentally. If unable to attach damper clamp, drill a hole (or holes) in the damper or remove it completely.

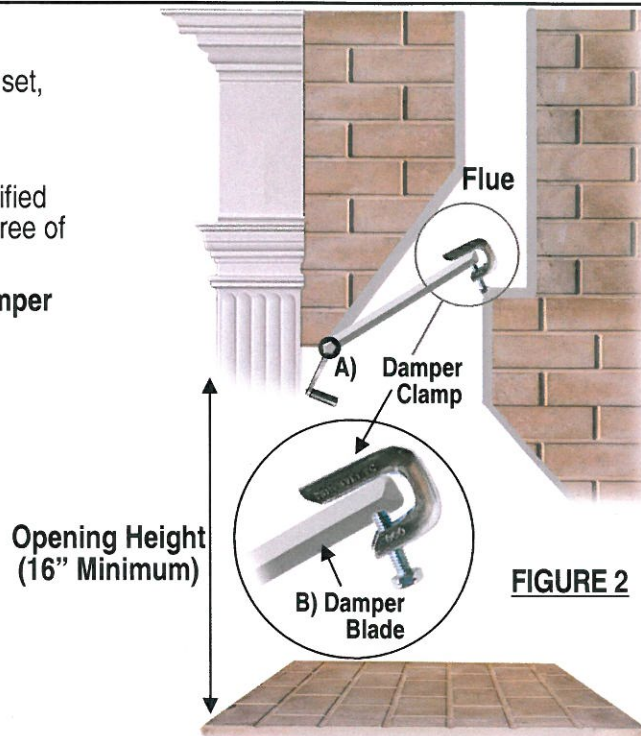
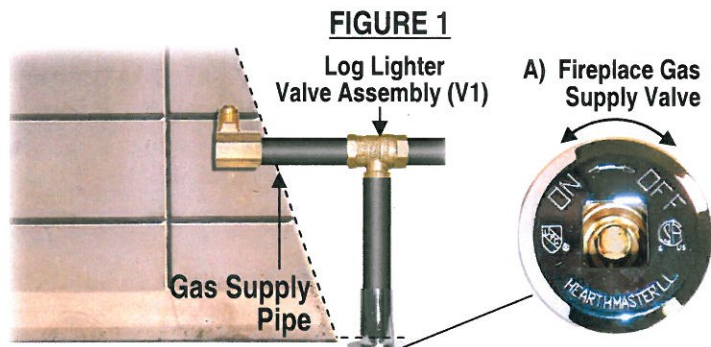

In the Commonwealth of Massachusetts:

- Installation must be performed by a licensed plumber or gas fitter.
- The chimney flue damper, when used with gas logs, will be welded open or completely removed.
- A CO detector shall be installed in the room where the appliance is installed.

IMPORTANT:

THE CHIMNEY DAMPER MUST BE WIDE OPEN AND FIXED IN A MANNER TO MAINTAIN A PERMANENT FREE OPENING AT ALL TIMES AS OUTLINED ABOVE. THE AREA OF THE FLUE MUST BE NOT LESS THAN 1/10 THE AREA OF THE FIREPLACE OPENING. THIS GAS LOG SET MUST BE INSTALLED IN A FULLY VENTED METAL OR MASONRY FIREPLACE WITH A WORKING FLUE THAT IS SAFE FOR BURNING A WOOD FIRE. THE FLUE MUST BE FREE OF ANY OBSTRUCTIONS AND MUST EXHAUST ALL PRODUCTS OF COMBUSTION. DAMPER AND GLASS DOORS MUST BE FULLY OPEN BEFORE LIGHTING OR BURNING FOR PROPER VENTILATION AND TO PREVENT HEAT DAMAGE TO THE VALVE.

WARNING! CHECK FOR PROPER VENTING

A properly sized, unobstructed chimney will normally vent all products of combustion. Any odor or smoke detected inside the room is an indication that the flue is not functioning properly.

SHUT OFF THE BURNER IMMEDIATELY! THE CAUSE OF THE VENTING PROBLEM MUST BE DISCOVERED AND CORRECTED BEFORE CONTINUED USE OF THE GAS LOG SET.

Continued use with improper venting may cause damage to your fireplace, room furnishings and could cause serious illness. **IF IMPROPER VENTING IS SUSPECTED, IMMEDIATELY HAVE LOG SET AND CHIMNEY FLUE SERVICED.**

The installation and the provisions for combustion and ventilation air must conform with *The National Fuel Gas Code ANSI Z223.1 / NFPA54*, or *The CSA B149.1, Natural Gas and Propane Installation Code*, latest edition.

INSTALLATION AND GAS SUPPLY CONNECTION

STEP TWO: BURNER INSTALLATION

1. Place **Burner-Grate Assembly** inside the firebox, centered from left to right, within 2" to 3" of rear wall (Figure 4).
2. The **"EASY" Safety Valve** or **"Millivolt"** should be placed as far forward and to the side of the burner pan as possible (Figure 4B). It may also be placed opposite side down (Figure 3, right)

STEP THREE: GAS SUPPLY CONNECTION

1. Insure that the Gas Supply to the Fireplace is turned off. Verify correct gas type and proper gas pressures.
2. Thread **1/2" FIP x 3/8" Flared Elbow** (Figures 3 and 4C) onto the **Gas Supply Pipe** (B) and wrench tighten.
3. Thread one end of the supplied **Flex Connector** (Figures 3 and 4E) to the **Valve Input** (Figure 5), then connect the other end to the **1/2" FIP x 3/8" Flared Elbow** attached to the Gas Supply Pipe. If Flex Connector is bent into too small a radius it may kink or break causing air flow noise and/or gas leaks.

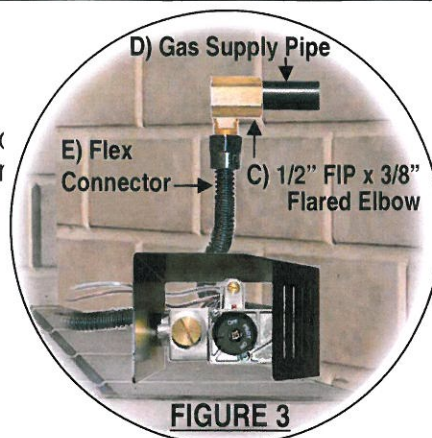

FIGURE 3

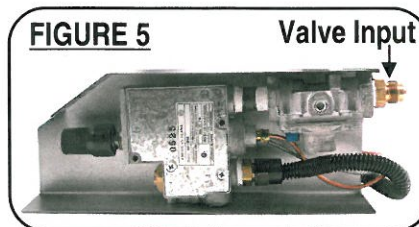
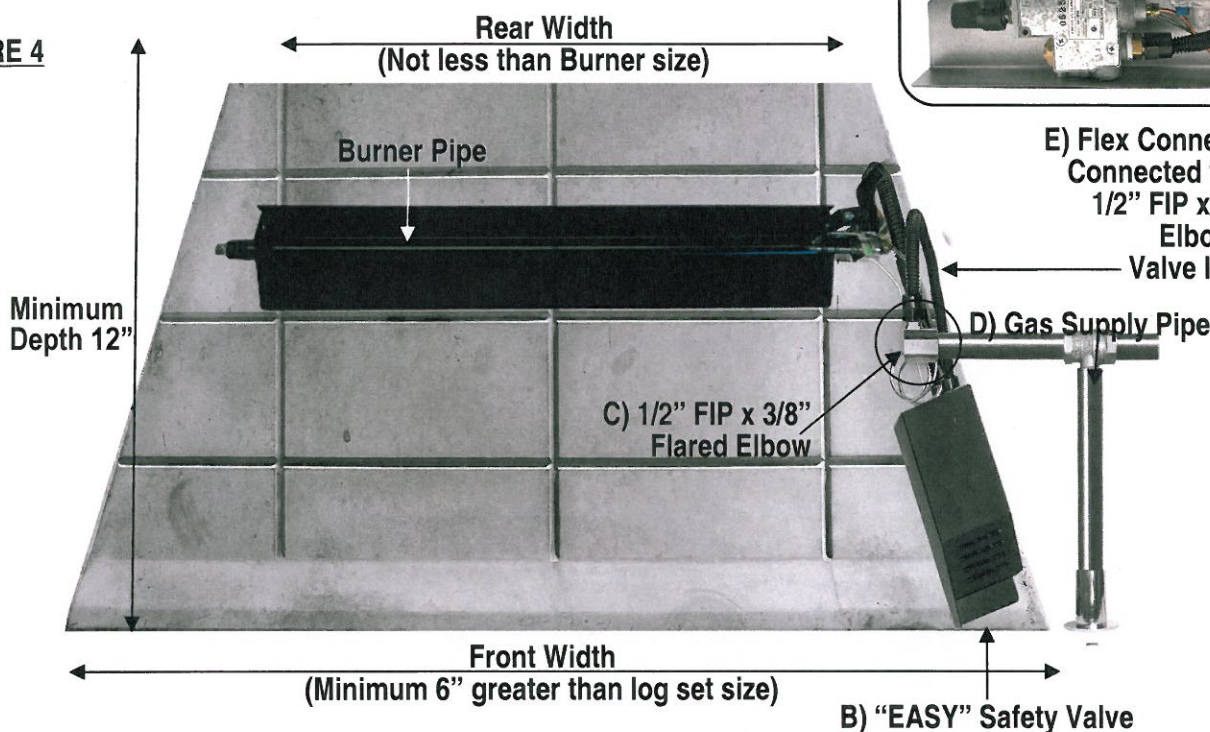

FIGURE 5

FIGURE 4



MINIMUM FIREPLACE REQUIREMENTS

The Minimum permanent chimney or damper opening is the minimum permanent free opening required by Standards or Codes to ensure safe operation of the appliance and must be at least 39 square inches for 15"-20" models, 51 square inches on 24" models and 64" on 30" models based on a minimum chimney height of 10 feet. It is **NOT** the minimum operating damper position.

MODEL	BURNER SIZE	OPENING HEIGHT	FIREBOX DEPTH	FRONT FIREBOX WIDTH	REAR FIREBOX WIDTH	CHIMNEY	MIN. PERMANENT CHIMNEY OPENING	BTU NAT. GAS	BTU L.P GAS
FGV/FDV/FBL18	18" to 21"	16"	12"	28"	18"	7"	39 SQ"	37,000	33,000
FGV18-VEI/MMV	18"	16"	12 1/8"	28 1/4"	18 3/4"	7"	39 SQ"	37,000	33,000
FGV/FDV-Z24	24" to 30"	16"	12"	34"	24"	7"	51 SQ"	70,000	55,000
FGV24-VEI/MMV	24"	16"	12 1/8"	34 1/4"	24 3/4"	7"	51 SQ"	70,000	55,000
FGV/FDV/FBL30	33" to 42"	16"	12"	40"	30"	8"	51 SQ"	80,000	60,000
FGV30-VEI/MMV	30"	16"	12 1/8"	40 1/4"	30 3/4"	8"	51 SQ"	80,000	60,000
FGV/FDV/FBL36	45" to 54"	16"	12"	46"	36"	9"	64 SQ"	86,000	70,000

PAN MEDIUM

(Amount supplied will vary with each size and style of burner)

STEP ONE: Before applying the Pan Medium. **Read and follow these instruction carefully:** Completely cover **Burner Pipe** and **Burner Pan** with Pan Medium (Figures 6 and 7) starting from rear of burner pan and moving toward leading edge. Use entire contents of bag provided, allowing Pan Medium to spill over leading edge of burner pan Figures 6B and 7B. If using a Propane Gas burner only, Do not clog air mixer (3/8" x 1/2" Reducing Coupling; part 9a on part list) with Pan Medium. Also, Do not place any Pan Medium around pilot assembly. See Figures 8 for applying the Pan Medium from the Log Lifter and moving toward to the leading edge.

FIGURE 6
Natural Gas

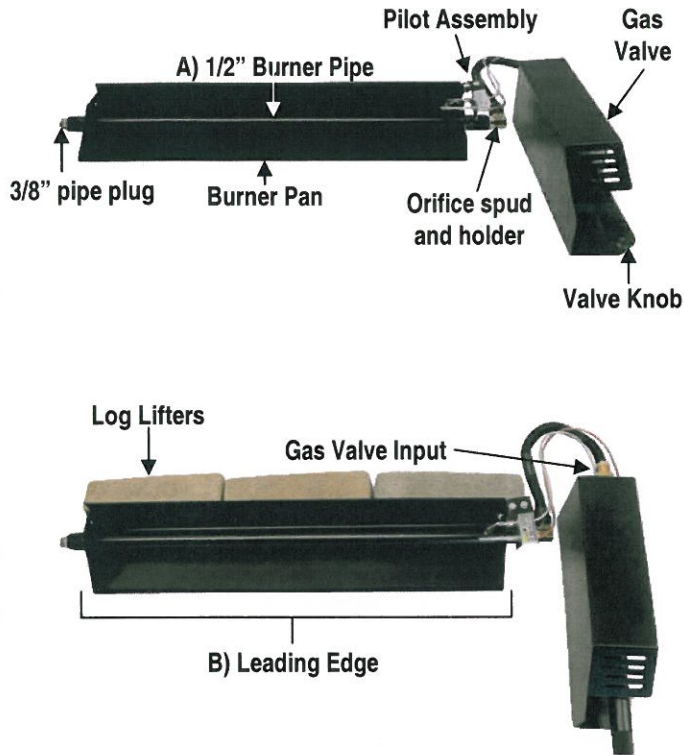
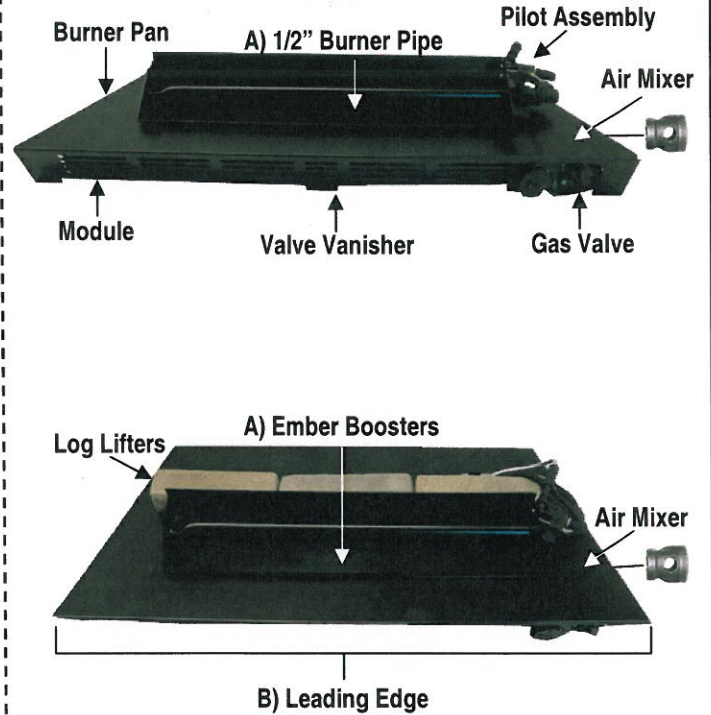

FIGURE 7
Propane



CAUTION: Covering the pilot with FireGlitter or FireDrops may result in shut down

A) Natural Gas



FIGURE 8

B) Propane



WARNING: Failure to position the parts in accordance with these diagrams or failure to use only parts specifically approved with this heater may result in property damage or personal injury.

PAN MEDIUM

CAUTION: Covering the pilot with FireGlitter or FireDrops may result in shut down

STEP TWO: Completely cover the Log lifter and begin filling the Pan Burner with Pan Medium (See Figures 9 or 10). Use entire contents of bag provided, allowing Pan Medium to spill over leading edge of burner pan Figures 6B and 7B on page 7. If using a Propane Gas burner, Do not clog air mixer (3/8" x 1/2" Reducing Coupling; part 9a on part list) with Pan Medium. Also, Do not place any Pan Medium around pilot assembly. See Figures 8 for applying the Pan Medium from the Log Lifter and moving toward the leading edge.

FIGURE 9



FIGURE 10



FIGURE 11

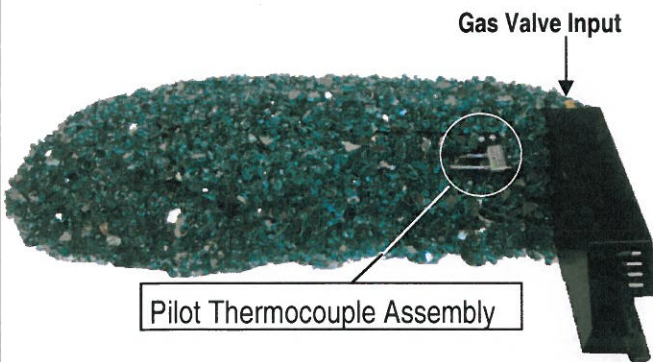
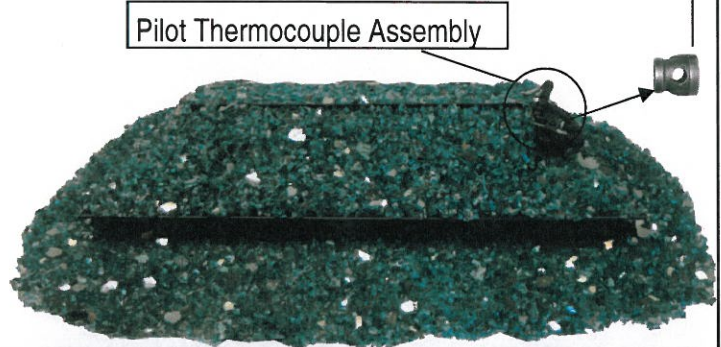

FIGURE 12

Note: Do Not clog Air Mixer with glass. (Propane Burner)



WARNING: POSITION GAS VALVE TO THE FRONT
OPENING OF FIREPLACE CLOSE TO SIDE WALL

WARNING: DO NOT BLOCK VALVE VANISHER VENTS,
AIR MIXER AND GAS VALVE WITH PAN MEDIUM

Available with the following FireGlitter and FireDrops

FireGlitter: Blue-Green (BG), Black (BL), Cobalt Blue (CB), Copper (CU), Platinum (PL)

FireDrops: Aqua-Blue (AB), Black (BL), Emerald Green (EG), Honey-Yellow (HY), Platinum (PL), Fire Red (FR)

WARNING: Failure to position the parts in accordance with these diagrams or failure to use only parts specifically approved with this heater may result in property damage or personal injury.

IMPORTANT! YOUR GAS LOG SET SHOULD BE OPERATED FOR THE FIRST 2-3 HOURS AT A LOW FLAME SETTING TO ALLOW TEMPERING OF THE REFRACTORY LOGS.

PLACEMENT OF "EASY" SAFETY VALVE AND REMOTE RECEIVER

The "Electronic Ignition" system has **Caution and Warning** that need to be follow. (See Figure 13) The "EASY" Safety Manual Valve (Figures 17A) has upgrade options such Remote Receiver (-RE (Variable Flame Height) and -SE (On/Off) models) (Figure 17B) are both adversely affected by heat and must be placed as **far forward and to the side of the fireplace as possible**. The "EASY" Safety Valve may also be placed open face side down with heat shield up as shown in Figure 14. Our optional **Ceramic Log House** accessory (item # RH3), offers heat protection for the Remote Receiver (Figure 16) and Battery Pack (Figure 15) while being pleasing to the eye.

FIGURE 13

FGV24-VEI/VMV
Natural Gas
Model shown at right
with
Blue-Green. (Glass)

WARNING

Battery pack needs to be installed outside the firebox and as far away as possible to assist in battery life and prevent overheating. Failure to follow these instructions can void warranty.

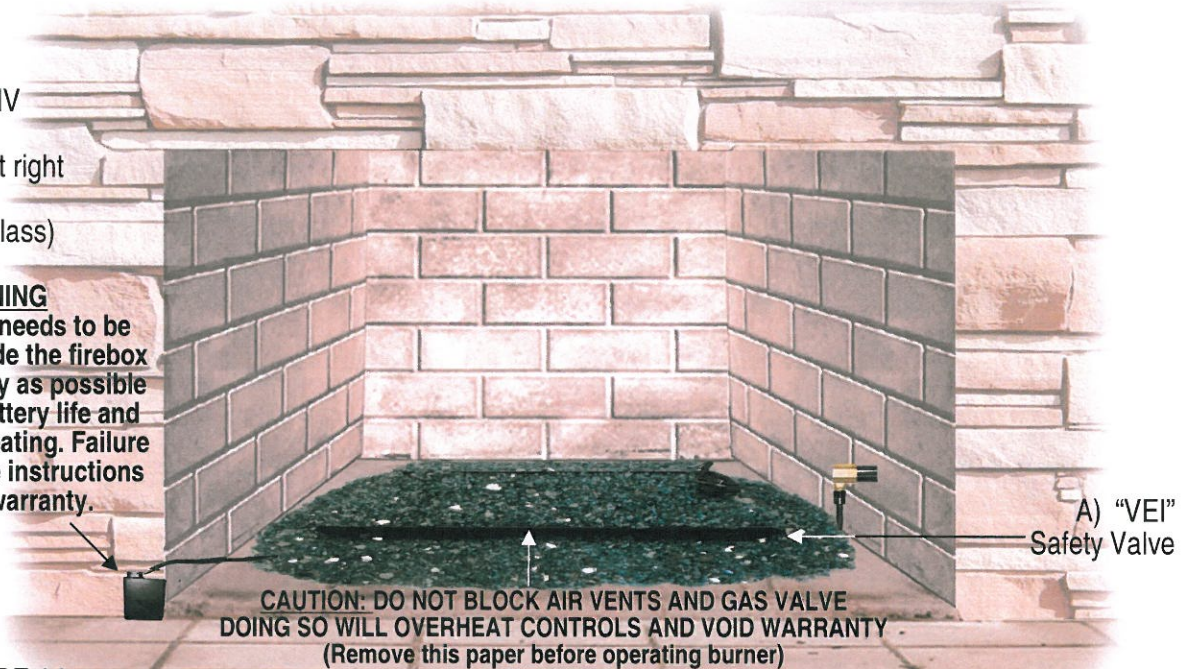

FIGURE 14

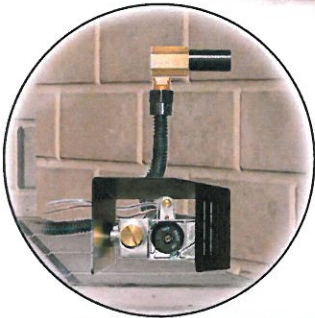

FIGURE 15

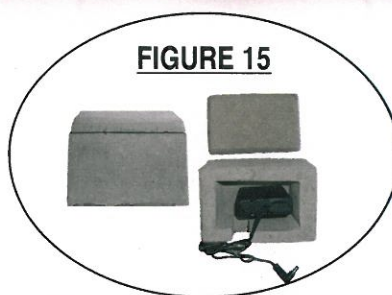

FIGURE 16

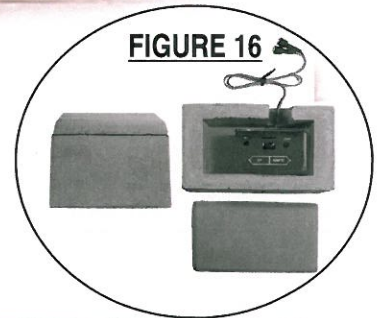

FIGURE 17

24" Natural Model
shown at right with
Blue-Green
FireGlitter (Glass)
Units.



LIGHTING AND OPERATION

IMPORTANT!

CHIMNEY DAMPER MUST BE WIDE OPEN! THE FLUE MUST VENT ALL PRODUCTS OF COMBUSTION. DAMPER AND GLASS DOORS MUST BE FULLY OPEN BEFORE LIGHTING OR BURNING FOR PROPER VENTILATION AND TO PREVENT HEAT DAMAGE TO VALVE.

STEP ONE: PILOT LIGHTING (ALL MODELS)

1. Turn **VALVE KNOB** (Figure 18A) to “PILOT” position.
2. Depress and hold until air is bled and gas flows to Pilot (Figure 18A).
3. Light Pilot with a Match or Lighter.
4. Once Pilot is lit, continue to depress and hold until the Pilot flame remains lit (approximately 30 to 60 seconds).
5. If Pilot does not remain lit, depress and turn Valve Knob clockwise to “OFF” position and wait at least 5 minutes to allow gas to dissipate. Repeat steps 1 thru 4.

FIGURE 18

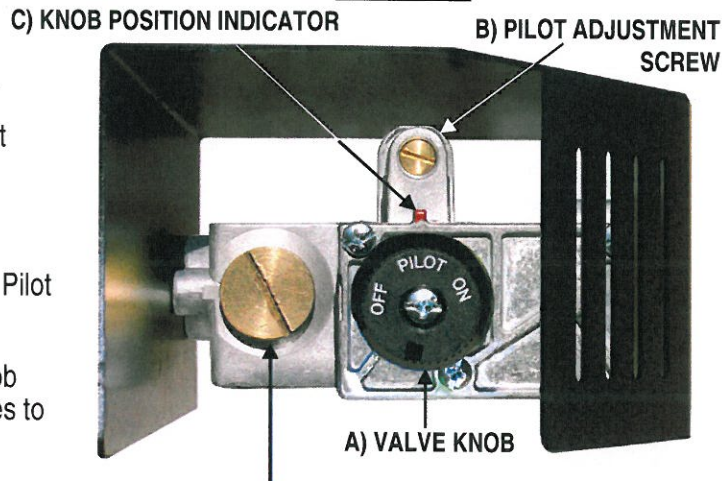

VALVE PLUG (“ME” MANUAL “EASY” CONTROL) SHOWN ABOVE ALSO, LOCATION FOR;

- **ON/OFF SOLENOID (“SE” REMOTE READY MODELS) OR**
 - **DC MOTOR DRIVE (“RE” VARIABLE FLAME HEIGHT MODELS)**
- BOTH SHOWN ON FOLLOWING PAGE.**

FIGURE 19

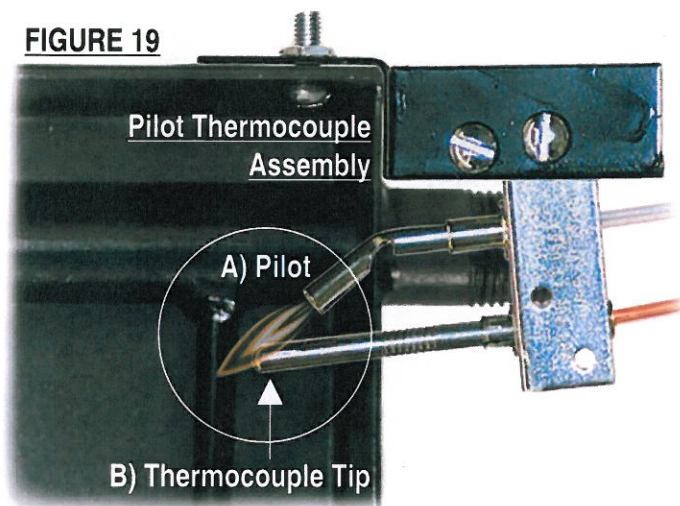

STEP TWO: PILOT ADJUSTMENT (ALL MODELS)

1. The Pilot flame should be steady, surrounding the **THERMOCOUPLE TIP** (Figure 19B).
2. If pilot flame adjustment is necessary, use a narrow long stem flathead screwdriver to turn **PILOT ADJUSTMENT SCREW** (Figure 18B) above.
3. Turn clockwise for less flame, counterclockwise for more.
4. If after pilot adjustment the burner begins to shutdown, re-adjust for a longer pilot flame.

STEP THREE: BURNER OPERATION (“ME” MANUAL “EASY” SAFETY CONTROL MODELS)

1. Turn **VALVE KNOB** counter clockwise to “ON” position (Figure 20).
2. Adjust the burner flame height by turning the valve knob clockwise to lower and counter-clockwise to raise up to full on.

NOTE: The **VALVE KNOB** has complete control of gas to the pilot and burner. It cannot be turned to “OFF” without first depressing dial to the “PILOT” position and then rotating clockwise to “OFF”. During the heating season leave valve knob in “PILOT” position for convenience. Otherwise, turn to “OFF” position for any prolonged non-use.

FIGURE 20

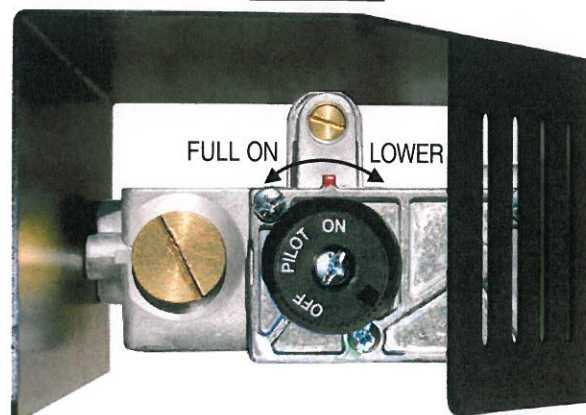

BURNER OPERATION (“RE” VARIABLE FLAME HEIGHT MODELS AND “SE” REMOTE READY MODELS)

1. Turn **VALVE KNOB** to “ON” position (Figure 21A)
2. Slide switch on the **RECEIVER** (Figure 22) to “**REMOTE**” position.

“RE Models

3. Depress the “ON/HI” button on the **TRANSMITTER** (Figure 22) until a click is heard. The burner will then light to “Full on”

NOTE: Reducing the burner flame can be achieved by pressing the “LO” button one beep at a time to the desired flame height. Pressing the “ON/HI” button one beep at a time will raise the burner flame). To verify the burner is completely off, press the “OFF” button once.

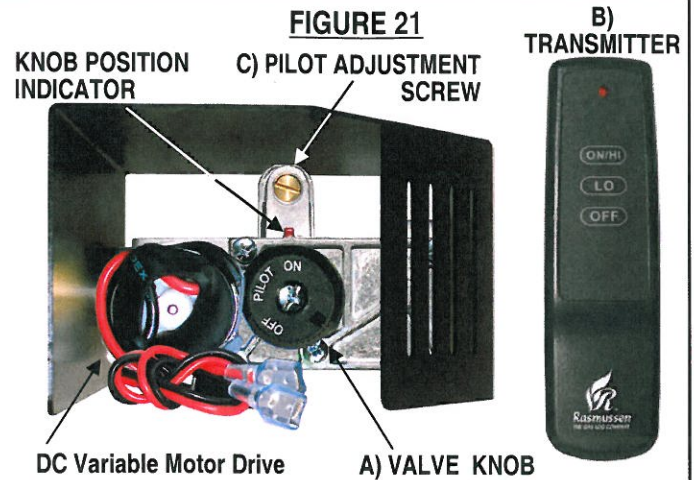

“SE” Models

3. Consult Operating Instructions for Accessory Control (below).
4. Adjust the burner flame height by turning the valve knob (Figure 23A) clockwise to lower and counter-clockwise to raise up to full on.

NOTE: During the heating season leave valve knob in “PILOT” position for convenience. Otherwise, turn to “OFF” position for any prolonged non-use.

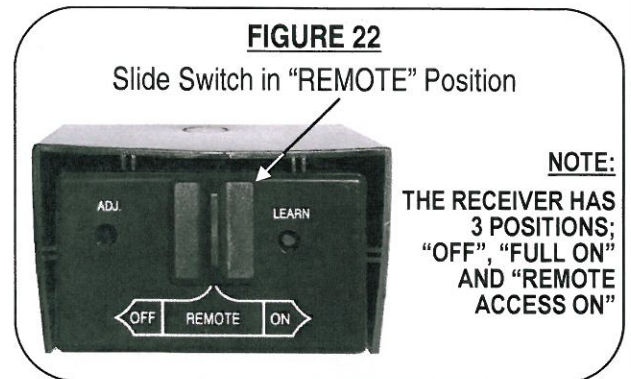

Accessory Controls

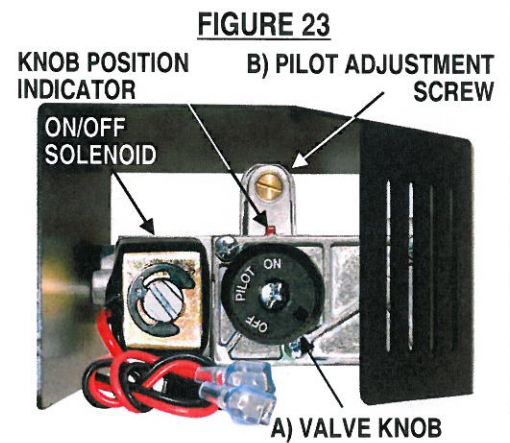
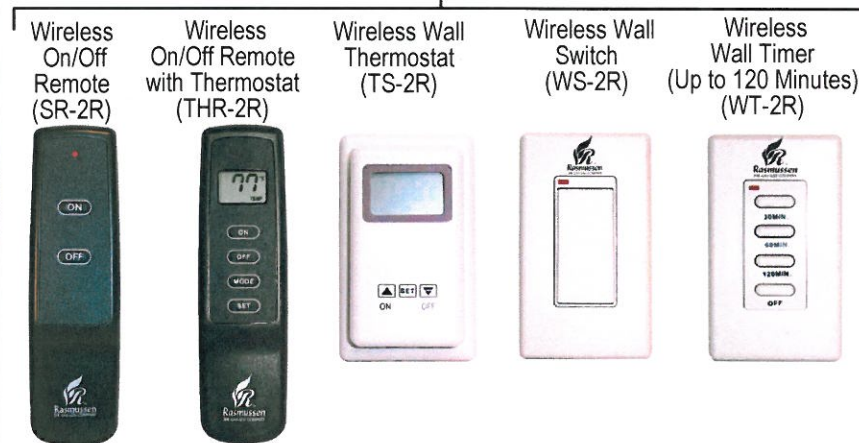

SERVICE AND TROUBLESHOOTING GUIDE FOR THE “EASY” SAFETY PILOT KIT

Analysis and correction of control of service problems must be made by qualified gas service technicians only. Attempts to service or repair the “EASY” Safety Pilot Kit by other than authorized service personnel will void the manufacturer’s warranty. In general, failure of “EASY” Safety Pilot Control may be due to the reasons noted below:

1. Pilot will not light initially:
 - Check for loose Thermocouple terminal nut connection.
 - Check for improper pilot flame adjustment.
 - Check that Valve Knob is fully depressed during pilot lighting operation and hold for 30 to 60 seconds.
 - Check for defective Thermocouple.
 - Check for defective thermo magnet unit.
2. Pilot / Main burner clicks off after 5 to 30 minutes of burning:
 - Valve and Thermocouple are not defective, otherwise pilot would not initially light.
 - Thermocouple loses temperature difference between hot tip and cold junction (base).
 - Check that only tip of Thermocouple is in main burner flame.
 - Remove then replace logs to alter heat radiation pattern. Ensure that glass doors are open.
 - Ensure that proper size gas log set is installed. Too large of a set decreases cooling air flow.

NOTE: The **Valve Knob** has complete control of gas to pilot and burner. The **Valve Knob** cannot be turned to "OFF" without first depressing knob in "PILOT" position and then rotating clockwise to "OFF".

STEP ONE: Pilot Lighting (Remote Valve):

1. Depress and turn **Valve Knob** clockwise to "OFF" position. (Figure 16)
2. Set Accessory Control (Figure 19) to "OFF" (Switch or Remote Control) or to lowest temperature setting (Thermostat)
3. Wait at least 5 minutes to allow gas which may have accumulated around burner to escape.
4. Turn **Valve Knob** counter clockwise to "PILOT" position. (Figure 17)
5. Depress and hold **Valve Knob** until air is bled and gas flows to pilot.
6. Light pilot (Figure 21). Continue to hold in the **Valve Knob** until the pilot flame remains lit when knob is released (approximately 60 to 90 seconds). If Pilot does not remain lit, repeat steps 1 through 5 and allow more time after pilot lighting before releasing knob.
7. Turn **Valve Knob** to "ON". (counter clockwise Figure 18) (Black terminal wire removed to allow unobstructed view)

FIGURE 16

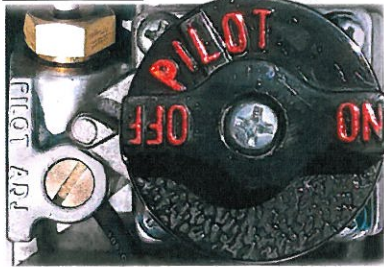

FIGURE 17

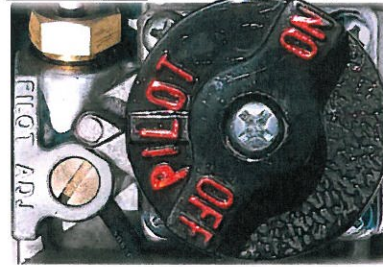

FIGURE 18



ADJUSTING BURNER FLAME HEIGHT USING THE REMOTE VALVE

Flame size at the burner is adjustable at the **Gas Valve Knob**. Turn the **Valve Knob** counter clockwise for more flame, clockwise for less flame.

For **Complete Shutdown (Including Pilot):** Slightly push and turn **Valve Knob** to "OFF".

Switch Accessory Wiring: Wiring from the Accessory Control (Remote, Thermostat or Switch) is connected to the **outside terminals** (Figure 20A and 20B) of the **Control Selector Switch** (Figure 19 and Figure 20C).

NOTE: Wire length for Thermostat, Remote or Controls should no exceed 20 feet. Thermostat wiring should be 20 AWG Type CL2

Switch Accessory Operation: Place the **Control Selector Switch** (Figure 19) in the "REMOTE ACCESS ON" position. Burner "ON" or "OFF" is now controlled by the position of the accessory control being used with the burner. Individual operating instructions for each Remote Accessory Option are included with the accessory.

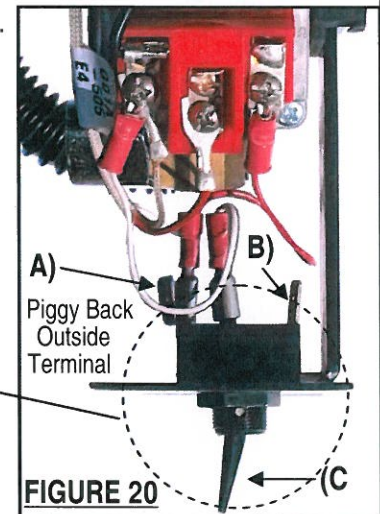
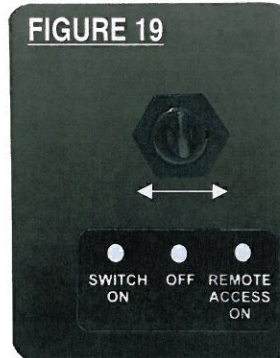
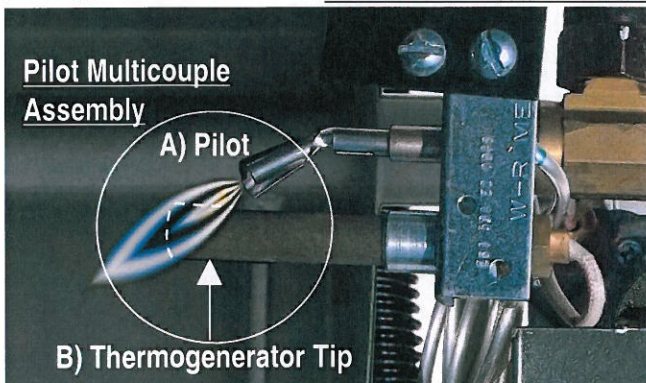

FIGURE 21

STEP TWO: PILOT ADJUSTMENT (Switch and Remote Valve)



1. The Pilot flame should be steady and soft blue, surrounding the **THERMOGENERATOR TIP** (Figure 21B).
2. If pilot flame adjustment is necessary, use a narrow long stem flathead screwdriver to turn **PILOT ADJUSTMENT SCREW** (Figure 18A) above.
3. Turn clockwise for less flame, counterclockwise for more.
4. If after pilot adjustment the burner begins to shutdown, re-adjust for a longer pilot flame.

Connecting Accessory Controllers: Using the 20' accessory control wiring attached to the two **outside terminals** of the valve block (Figure 20A and 20B), connect the **Switch Control Accessory Option** (Remote, Thermostat, Switch, etc.) to valve.

NORMAL OPERATING CHARACTERISTICS

Each and every **Yellow Flame** that leaves the factory is quality checked to ensure compliance with our certification. This check includes an operational test to ensure both satisfactory combustion and proper operation.

A normally operating Yellow Flame Gas Fire Set possess the following characteristics:

- A yellow bodied wood-like flame that will produce carbon soot. The carbon soot produced is natural and adds to the realistic appearance of the set. If the carbon becomes excessive, operate the set for ten minutes to heat the Fire-Glass or FireDrops, then spray the sooty area with water. This dislodges the soot, which is carried up the chimney by the natural draft.
- The pilot flame should be blue in appearance.

CUSTOMER RESPONSIBILITIES AND PERIODIC MAINTENANCE

- Keep the area around the **Yellow Flame** free and clear from debris.
- From time to time, visually check pilot and burner flames for proper appearance.
- The pilot burner should be free of lint and dirt. Use a brush with stiff bristles to clean the pilot.
- The main burner should produce a relatively even flame from side to side. If the flame tends to originate from one side, the sand or volcanic ash may have become packed on the other side. When the set is off and cool, loosen the sand or volcanic ash with a wire or knife blade to allow a freer flow of gas.
- Periodically examine and clean the venting system. Once every year, a qualified agency or certified chimney sweep should examine and clean the venting system of the solid fuel burning fireplace in which the **Yellow Flame** installed (if applicable).
- The air mixer (Propane gas) and burner must be free of lint and dirt for optimum performance. Air shutters which have been closed or are obstructed with debris will not allow sufficient combustion air into the burner. Use compressed air and/or a soft bristle brush to clean the air shutter area. **Air shutters should not be altered from factory settings.**
- Do not operate this set with any burner objects other than the **RASMUSSEN** Gas Logs specifically designed and approved for use with this Burner System.
- Do not use with blower inserts or heat exchangers.
- If used, glass doors must be wide open when burner is on.
- Do not remove Rating Plate/Warning Tags. These tags serve you and any future user as an integral safety and identification component of the **Yellow Flame** gas log heater. **Removing these tags voids the warranty.**
- **WARNING: Do not allow fans to blow directly into fireplace. Avoid any drafts that alter burner flame patterns.** Do not place blower inside area of firebox. Ceiling fans may create drafts that alter burner flame patterns. Sooting and improper burning may occur. Sooting can settle on surfaces outside the fireplace.

WARNING: Failure to position the parts in accordance with the diagrams in this manual or failure to use only parts specifically approved with this appliance may result in property damage or personal injury.

IMPORTANT

This Yellow Flame Gas Log set is for use only in a fully functioning wood burning fireplace with the damper wide open. The flue must vent all of the products of combustion.

KEEP BURNER AREA CLEAN AND PERFORM AIR INTAKE PORTS CLEANING ANNUALLY

IMPORTANT SERVICE TIP!

Obstructed Pilot Air Intake Ports result in an improper gas/air mixture and a weak pilot flame. **Weak pilot flame is the NUMBER 1 SERVICE ISSUE REGARDING NUISANCE SHUT-OFF.** Using canned compressed air, blow out the opposing air intake ports located at the base of the pilot. (where the gas supply line attaches to the pilot)

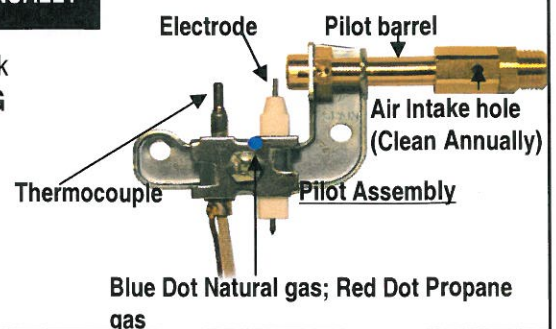

TROUBLESHOOTING

Safety Pilot Lighting Issues

- Check for loose Thermocouple terminal nut connection.
- Check that pilot flame strikes thermocouple—Adjust as needed.
- Check that Valve Knob is fully depressed during pilot lighting operation and held depressed for 30 to 60 seconds with pilot flame lighted.

Nuisance Shutdown of Burner or Pilot/

Pilot Difficult to Light or Unable to Remain Lighted After Months or Years of Use

Most likely cause: Air in the gas line, dust intrusion under the pilot hood, low pilot flame.

Fix: Bleed gas line free of all air, blow out pilot hood, adjust pilot flame. Perform this cleaning annually or as required to prevent nuisance shutdown.

Burner is Excessively Noisy

Please Note: The movement, mixing of air and gas, and combustion will create a low, throaty sound, which is normal.

Excessive gas pressure: Make sure the gas pressure coming into the fireplace does not exceed the maximum pressure allowed with this gas set (refer to the table on pages 5).

Passage of air/gas across irregular surfaces: There may be burrs, paint or other blockages on the burner bar ports. Check these ports and remove any blockage.

Gas Connector: Relieve any tight bends or kinks in the Flex Connector. Switch to a smooth aluminum connector, which can be purchased at hardware or home improvement stores.

Burner Flame is Too High (8-12" Above Top Logs) or Too Low (Below Top Logs)

Incorrect gas supply, pressure, or burner orifice used: 1) Ensure gas type of set is proper for gas type being used. Make sure the gas pressure coming into the fireplace falls between the minimum and maximum pressures allowed with this gas set (refer to the table on page 5).

Blocked ports (low flame only): Free the main burner orifice and burner bar ports of any burrs, paint or other blockage.

Receiver Beeps (SE and RE Models)

Most likely cause: Receiver has become too hot, triggering over-temperature safety feature.

Fix: Move receiver into a cooler area of firebox, onto the hearth, and/or place in accessory RH2 Remote House.

Odor and/or Smoke After Break-in Period (other than Natural Odor of Gas Combustion)

Most likely causes: Lack of fresh air and/or impurities in the room air. Since the appliance is drawing its combustion air from the living area, any odors or impurities present in the room will be recycled through the flame and recirculated back into the room. Such impurities include: pet hair, fresh paint or varnish, paint remover, cigarette smoke, potpourri and incense, cements and glues, new carpet or textiles, dust build-up, and residue from previous wood burning left in the fire-box. and flue, among other things.

Fix: Add fresh air. Remove sources of impurities.

NOTE—The installation of appliances in a manufactured home (U.S. only) or mobile home installation must conform with the Standard *CAN/CSA Z240 MH, Mobile Housing*, in Canada, or with the *Manufactured Home Construction and Safety Standard, Title 24 CFR, Part 3280*, in the United States, or when such a standard is not applicable, *ANSI/NCSBCS A225.1/NFPA 501A, Manufactured Home Installations Standard*.

HOW TO ORDER PARTS

Parts can be ordered through the supplier from whom you purchased your Yellow Flame Log Set or from Rasmussen. When ordering parts, please specify;

1. Model number and Serial number of the Burner (available on the Rating Plate).
2. Model number of the objects set.
3. Type of Gas (natural or propane) and control type (ME, RE or SE; VEI)
4. The name of part with part number (located on parts list, page 3) or specific object throughout manual.

TWO YEAR CONSUMER PRODUCT WARRANTY

The following warranty has been drafted to comply with the MAGNUSON-MOSS WARRANTY ACT applicable to products manufactured after July 4, 1975, It replaces and supersedes any warranty in this package or in any printed literature.

LIMITED WARRANTY:

RASMUSSEN IRON WORKS INC, 12028 E. Philadelphia Street, Whittier California, U.S.A., warrants this Gas Fire Set and accessories against defects in materials and workmanship, and suitable for a particular purpose, for a period of:

- (1) OBJECT CASTING - All logs are guaranteed against burnout in the original installation for 2 years from the date of initial purchase.
- (2) BURNERS, SHEET METAL, SAFETY CONTROLS AND ALL OTHER COMPONENTS - 2 Years from date of initial purchase.

When used in an outdoors or commercial installation, the warranty period shall be six (6) months. Warranty does not extend to corrosion of parts used in outdoor environment.

THIS WARRANTY IS FOR THE BENEFIT OF THE ORIGINAL PURCHASER.

WARRANTY ADJUSTMENT:

- (1) RASMUSSEN agrees to repair or furnish a replacement for, but not remove or install any product or component which proves defective within the above warranty and appropriate time periods stated.
- (2) BUYER notify RASMUSSEN of any defect within this warranty no later than thirty (30) days after a defect is discovered.
- (3) No product will be accepted for return or replacement without written authorization of RASMUSSEN. Before returning merchandise, write to RASMUSSEN Giving us full details of the complaint and a copy of the sales receipt or other evidence of the purchase date. Merchandise returned without proof of purchase date will be serviced out-of-warranty at our prevailing service and parts rates. If merchandise was damaged in transit, the file claim must be addressed as follows:

**RASMUSSEN IRON WORKS INC
12028 E. PHILADELPHIA STREET
WHITTIER, CALIFORNIA 90601**

**Shipping charges must be pre-paid by the buyer.
REPAIR OR REPLACEMENT UNDER THIS WARRANTY
WILL BE SHIPPED FREIGHT COLLECT.**

EXCLUSIONS FROM WARRANTY:

- (1) The foregoing warranty is limited solely as set forth herein and applies only for the designated above.
- (2) RASMUSSEN shall not be liable for any loss, damage incidental or consequential damages of any kind, whether based upon warranty, contract, or negligence, arising in connection with the sale, use or repair of the product. Some states do not allow the exclusion or limitation of incidental or consequential damages, so the above limitation or exclusion may not apply to you.
- (3) The maximum liability of RASMUSSEN in connection with this limited warranty shall not in any case exceed the contract price paid for the product claimed to be defective or unsuitable.
- (4) This warranty does not extend to any product manufactured by RASMUSSEN which has been subjected to misuse, neglect, accident improper installation, or use in violation of instructions furnished by RASMUSSEN. Do not remove Rating Plate/Warning Tags. These tags serve you and any future user as an integral Safety and identification component of the CHILLBUSTER gas log heater. Removing these tags voids the warranty.
- (5) This warranty does not extend to or apply to any unit which has been repaired or altered in any place other than RASMUSSEN IRON WORKS INC. factory, or by persons not expressly approved by RASMUSSEN.
- (6) Components manufactured by any supplier other than RASMUSSEN shall bear only that warranty made by the manufacturer of that product.
- (7) Freight damage, cracking from thermal shock, and color changes occur from causes beyond manufacturer's control and are not covered by any warranty.

THIS WARRANTY GIVES YOU SPECIFIC LEGAL RIGHTS, AND YOU MAY ALSO HAVE OTHER RIGHTS WHICH VARY FROM STATE TO STATE.

RASMUSSEN IRON WORKS, INC. shall be held harmless from any and all claims by the buyer as a result of injury or damage to an ultimate user or other person caused by the product sold herein by the seller to the buyer, whether the injury or damage results from the assembly, product installation, operation, shipment, storage or manufacture of this product. RASMUSSEN IRON WORKS, INC makes no warranties, expressed or implied, other than those expressly stated herein.

CONSUMER RECORD CARD

FOR CUSTOMER RECORDS ONLY.
DO NOT SEND THIS CARD TO MANUFACTURER



LOG MODEL: _____

SAFETY CONTROL: _____

DATE OF PURCHASE: _____

DEALER: _____

INSTALLER: _____