

- Please check your product packaging to make sure the included accessories are in the "list of standard accessories". If any parts are missing, please contact your local dealer immediately.

- Do not allow any sharp objects to come in contact with the cabinet, as it will scratch the surface.

- Continuous and prolonged exposure to direct sunlight may cause discoloration to the wood.

- Do not put any hot appliances directly on or near the cabinet.

- Please avoid using cleaning products that contain bleach or ammonia.

- Wood surfaces should only be cleaned with wood care products such as soapy water or furniture polish.

- Vérifiez l'emballage de votre produit SVP pour assurer que les accessoires fournis sont dans la liste des accessoires standards".

- S'il manque des pièces, veuillez contacter immédiatement votre distributeur sur place.

- Les objets pointus sont interdits de toucher le meuble, car ils gratteront le surface.

- L'exposition continue directement sous le soleil peut provoquer une décoloration du bois.

- Ne placez aucune chose chaude directement sur la table ou à côté du meuble.

- N'utilisez pas des produits de nettoyage qui content de l'eau de javel ni de l'ammoniac.

- Les surfaces ne doivent être nettoyées qu'avec produits d'entretien du bois ou de l'eau savonneuse ou vernis pour meubles.

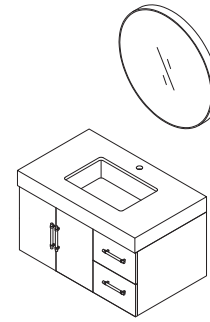

## Main Body Parts/La partie principale du corps

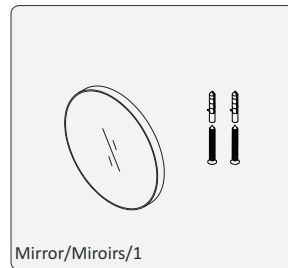
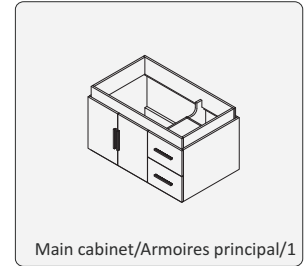
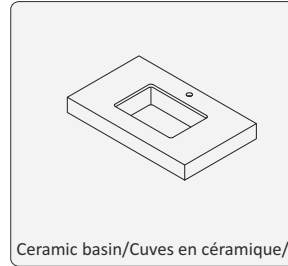

## Installation Parts/Partie d'installation

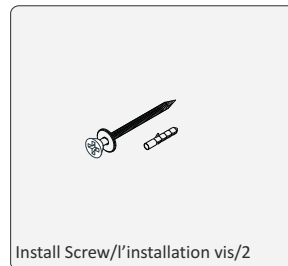

## Installation/l'installation

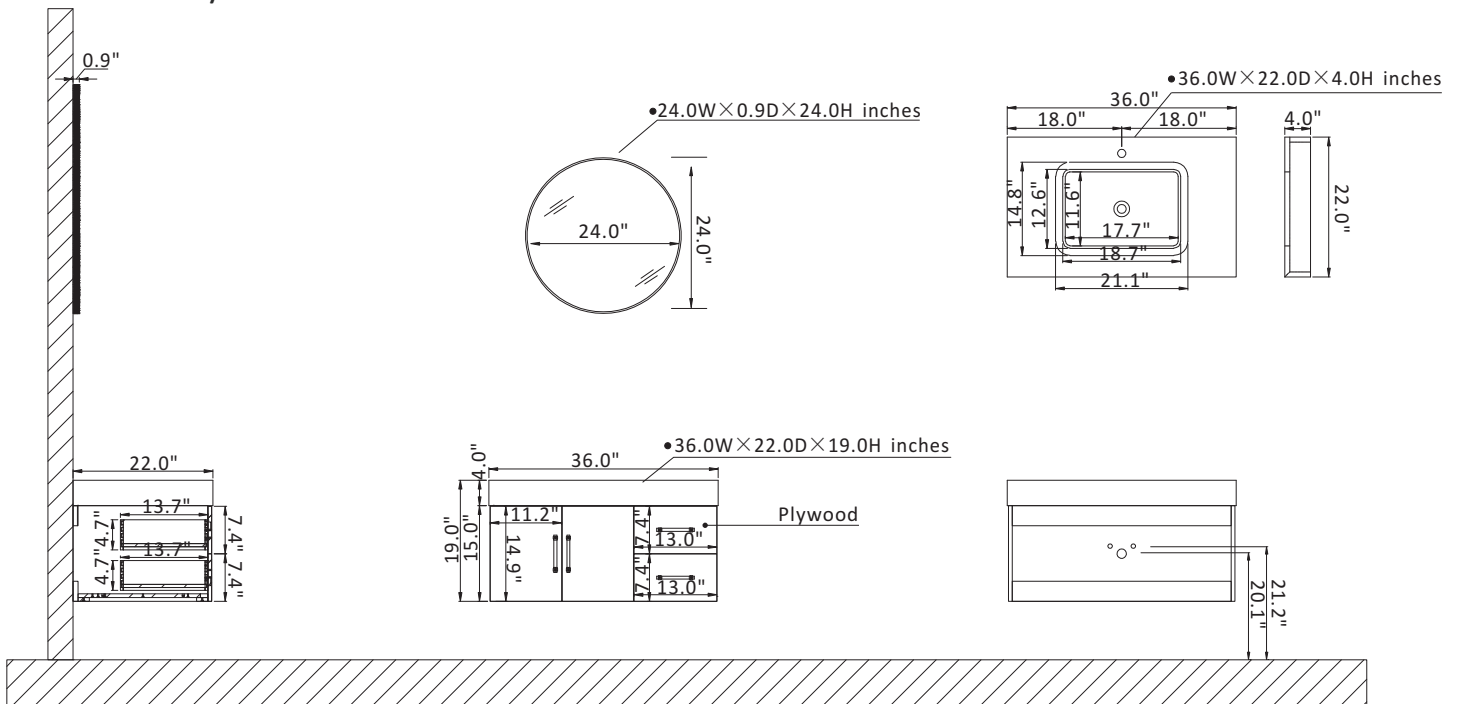

## Erecting Tool/Outils d'assemblage

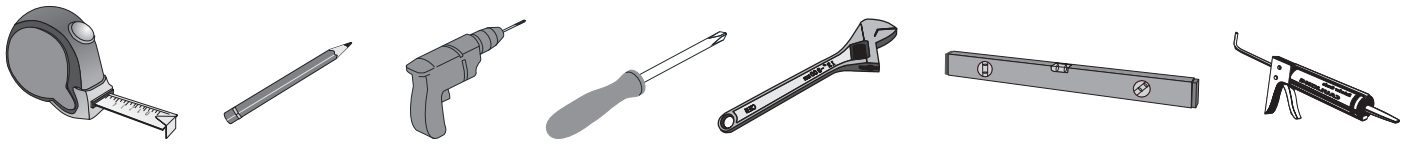

### Install, Remove, Adjust Of Top Fast Loading Hinge / Montage, démontage et réglage de la charnière de chargement rapide



Install/l'installation

Remove/mobiles

Adjust the height/Hauteur de réglage

adjust the lateral/Réglage latéral

Adjust the depth/Profondeur de réglage

### Installation Instruction/Instructions d'installation

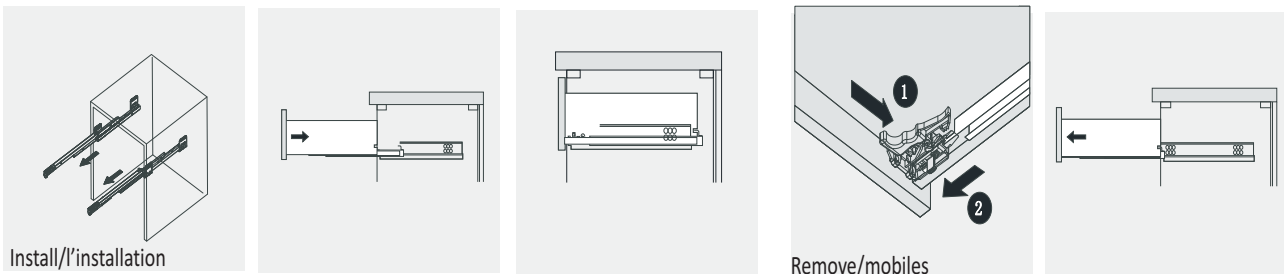

Install/l'installation

Remove/mobiles

### Drawer Adjust/ tiroir ajuster

