

TM

Alfresco™

Open Air Culinary Systems



Care and Use Manual
For all ALXE models

GENERAL SAFETY PRECAUTIONS:

 **DANGER**

IF YOU SMELL GAS:

1. SHUT OFF GAS TO THE APPLIANCE
2. EXTINGUISH ANY OPEN FLAME.
3. OPEN LID.
4. IF ODOR CONTINUES, KEEP AWAY FROM THE APPLIANCE AND IMMEDIATELY CALL YOUR GAS SUPPLIER AND OR FIRE DEPARTMENT.

 **WARNING**

1. DO NOT STORE OR USE GASOLINE OR OTHER FLAMMABLE LIQUIDS OR VAPORS IN THE VICINITY OF THIS OR ANY OTHER APPLIANCE.
2. AN LP CYLINDER NOT CONNECTED FOR USE SHALL NOT BE STORED IN THE VICINITY OF THIS OR ANY OTHER APPLIANCE.

 **DANGER**

S'IL Y A UNE ODEUR DE GAZ:

1. COUPEZ L'ADMISSION DE GAZ DE L'APPAREIL.
2. ÉTENDRE TOUTE FLAME NUE.
3. OUVRIR LE COURVERCLE.
4. SI L'ODEUR PERSISTE, ÉLOIGNEZ-VOUS DE L'APPAREIL ET APPELEZ IMMÉDIATEMENT LE FOURNISSEUR DE GAZ OU LE SERVICE D'INCENDIE.

 **AVERTISSEMENT**

1. NE PAS ENTREPOSER NI UTILISER DE L'ESSENCE NI D'AUTRES VAPEURS OU LIQUIDES INFLAMMABLES DANS LE VOISINAGE DE L'APPAREIL, NI DE TOUT AUTRE APPAREIL.
2. UNE BOUTEILLE DE PROPANE QUI N'EST PAS RACCORDÉE EN VUE DE SON UTILISATION. NE DOIT PAS ÊTRE ENTREPOSÉE DANS LE VOISINAGE DE CET APPAREIL OU DE TOUT AUTRE APPAREIL.

WARNING:

- If the information in this manual is not followed exactly, a fire or explosion may result causing property damage, personal injury or death.
- Do not try lighting this appliance without reading the **LIGHTING INSTRUCTIONS** section of this manual. For outdoor use only.
- This cooking appliance is not intended to be installed in or on recreational vehicles and / or boats.

BEFORE USING THE GRILL:

- Ensure that the grill has been leak tested. (see page 11)
- Remove any packing material.
- Read and understand the instructions in this manual.
- Electric power supply must be plugged-in at all times for barbecue operation; except during any electrical maintenance.

 **WARNING**

ELECTRICAL PARTS AND COMPONENTS
DISCONNECT ALL POWER SUPPLIES AND BATTERIES BEFORE SERVICING.

 **WARNING**

FLAMMABLE GAS
DISCONNECT ALL PROPANE OR NATURAL GAS SUPPLIES TO THIS UNIT BEFORE SERVICING.

 **AVERTISSEMENT**

PIÈCES ÉLECTRIQUES ET COMPOSANTS.

DÉBRANCHER TOUS LES BLOCS D'ALIMENTATION ET LES PILES AVANT DE LES RÉPARER.

 **AVERTISSEMENT**

GAZ INFLAMMABLE

DÉBRANCHER TOUS LES GAZ PROPANE OU GAZ NATUREL DE CET APPAREIL AVANT DE PROCÉDER À L'ENTRETIEN.

TESTED IN ACCORDANCE WITH: *ANSI Z21.58-2018 / CSA 1.6-2018*

The Standard for Outdoor Cooking Gas Appliances.

Installation of this cooking appliance must be made in accordance with local codes. In the absence of local codes, this unit should be installed in accordance with the *National Fuel Gas Code No. Z223.1/NFPA 54, Natural Gas and Propane Installation code CSA B149-1*, or *Propane Storage and Handling Code B149.2*. All Electrical Components must be electrically grounded in accordance with local codes or in the absence of local codes with the *National Electrical Code ANSI/NFPA 70* or *Canadian Electrical code CSA C22.1*

CALIFORNIA PROPOSITION 65 - WARNING

The burning of gas cooking fuel generates toxic by-products, which are on the list of substances which are known by the State of California to cause cancer or reproductive harm. California law requires businesses to warn customers of potential exposure to such substances. To minimize exposure to these substances, always operate this unit according to the use and care manual, ensuring you provide good ventilation when cooking with gas. This warning is issued pursuant to California Health & Safety Code Sec. 25249.6

PASTE SERIAL NUMBER
LABEL IN THIS LOCATION

BARBEQUE SERIAL NUMBER LABEL

SAFETY PRACTICES TO AVOID PERSONAL INJURY

READ THIS CARE AND USE MANUAL CAREFULLY AND COMPLETELY BEFORE USING YOUR GRILL TO REDUCE THE RISK OF FIRE, BURN HAZARD OR OTHER INJURY. KEEP THIS MANUAL FOR FUTURE REFERENCE.

When properly cared for, your *Alfresco*™ Gourmet Grill will give safe, reliable service for many years. However, extreme care must be used since the grill produces intense heat, which can increase accident potential. When using this appliance, basic safety practices must be followed, including but not limited to the following:

- Begin by ensuring proper assembly. A qualified technician should perform all other service.
- Do not repair or replace any part of the grill unless specifically recommended in this manual.
- All other service should be referred to and performed by a qualified technician.
- For personal safety, wear proper apparel while barbecuing.
- Loose fitting garments or sleeves should never be worn while using this appliance.
- Some synthetic fabrics are highly flammable and should not be worn while cooking.
- Never let clothing, pot holders or other flammable materials come in contact with or too close to any grate, burner or hot surface until it has cooled down sufficiently. Fabrics may ignite and result in personal injury.
- Use only dry potholders: moist or damp potholders on hot surfaces may cause personal burns from steam. Do not use a towel or bulky cloth in place of potholders. Do not let potholders touch hot portions of the grill rack.
- Only certain types of glass, heatproof glass ceramic, earthenware, or other glazed utensils are suitable for grill use. These types of materials may break with sudden temperature changes. Use only on low or medium heat settings and according to their manufacturer's directions.
- Grease is flammable. Let hot grease cool before attempting to handle it.
- Avoid letting grease deposits collect in the bottom of the grill by cleaning the grease tray often. Never while grill is on or hot from recent use; pan will not come out.
- Do not use aluminum foil to line the grill racks, nor to line the drip tray. This can severely upset combustion airflow or trap excessive heat in the control area. The result of this can be melted knobs, igniters and increased chance of personal injury. Never grill without the drip pan in place and pushed all the way to the back of the grill. Without the drip pan, hot grease can leak downward creating a fire or explosion hazard.
- Children should not be left alone or unattended in an area where the grill is being used. Never allow them to sit, stand or play on or around the grill. Do not store items of interest to children around or below the grill or in the cart. Never allow children to crawl inside of the cart.
- Do not heat unopened food containers that may cause the container to build-up pressure and burst.
- Protect your hand when opening a hot grill lid. Never lean over an open hot grill.
- When lighting a burner, always pay close attention to what you are doing. Be certain you are depressing the correct igniter button labeled for the burner you intend on using.
- When using the grill: do not touch the grill rack, burner grate, hood or immediate surrounding area as these areas become extremely hot and could cause burns. Use only the handles and knobs provided for operation of the grill.

- For proper lighting and performance of the burners keep the ports clean. It is necessary to clean them periodically for Optimum performance. The burners will only operate in one position and must be mounted correctly for safe operation.
- Clean the grill with caution. Avoid steam burns; do not use a wet sponge or cloth to clean the grill while it is hot. Some cleaners produce noxious fumes or can ignite when applied to a hot surface.
- **INSECT WARNING:** Spiders and insects can nest in the burners of this and other grills, and cause the gas to flow from the front of the burner. This is a very dangerous condition, which can cause a fire to occur behind the valve panel, thereby damaging the grill and making it unsafe to operate. Inspect the grill at least twice a year.
- Be sure all grill controls are turned off and the grill is cool before using any type of aerosol cleaner on or around the grill. The chemical that produces the spraying action could, in the presence of heat, ignite or cause metal parts to corrode.
- Do not use this appliance under overhead combustible surfaces. Use only in well ventilated areas. Do not use in buildings, garages, sheds, breezeways or any enclosed areas.
- Keep the area surrounding the grill free from combustible materials, trash, or combustible fluids and vapors such as gasoline or charcoal lighter fluid. Do not obstruct the flow of combustion gases and ventilation airways.
- Keep the back of the cart free and clear from debris.
- If the unit is stored indoors ensure that it is cool. If propane is used, the cylinder must be unhooked and the propane cylinder stored outside in a well-ventilated area, out of reach of children.
- Never use the grill in windy conditions. If located in a consistently windy area, oceanfront, mountaintop, etc... a windbreak will be required. Always adhere to the specified clearances.
- Keep any electrical supply cord, away from the heated areas of the grill.

⚠ WARNING

**FOR OUTDOOR USE ONLY
NOT TO BE INSTALLED IN OR
ON RECREATIONAL VEHICLES
AND / OR BOATS.**

⚠ WARNING

**NEVER USE A DENTED OR
RUSTED LIQUID PROPANE
TANK. SHUT OFF TANK WHEN
NOT IN USE.**

⚠ AVERTISSEMENT

**POUR UTILISATION À
L'EXTÉRIEUR
NE PAS ÊTRE INSTALLÉ DANS OU
SUR DES VÉHICULES RÉCRÉATIFS
ET / OU DES BATEAUX.**

⚠ AVERTISSEMENT

**N'UTILISEZ JAMAIS DE RÉSERVOIR
DE PROPANE LIQUIDE BOSSELÉ
OU ROUILLÉ. ÉTEINDRE LE RESER-
VOIR LORSQU'IL N'EST PAS UTILI-
SÉ.**

LOCATING AND ASSEMBLING THE GRILL:

When determining a suitable location for your grill, take into account concerns such as exposure to wind, rain, sprinklers, proximity to traffic paths and keeping any gas supply line runs as short as possible.

Locate the grill only in a well-ventilated area. Never locate the grill in a building, garage, breezeway, shed or other such enclosed areas without an approved ventilation system. Never locate the grill over, under or next to unprotected combustible construction. During heavy use, the grill will produce a lot of smoke.

CLEARANCES:

TO NON-COMBUSTIBLE CONSTRUCTIONS:

A minimum of **3-5/8"** clearance from the back of the grill to non-combustible construction is required to allow the hood to be opened fully.

TO COMBUSTIBLE CONSTRUCTIONS:

The minimum clearance of the unit to combustible construction is:

12" FROM SIDES AND 12" FROM BACK.

DO NOT USE THIS APPLIANCE UNDER OVERHEAD COMBUSTIBLE SURFACES.

FOR BUILT-IN APPLIANCES: Only for installation in a built-in enclosure constructed of non-combustible materials or for installation in a built-in enclosure of combustible materials when installed with *Alfresco*[™] Insulating Jackets Part No.:

AIJ-30 (30"), AIJ-36 (36"), AIJ-42 (42") OR AIJ-56 (56")

ASSEMBLY:

BUILT-IN MODELS:

Before locating your *Alfresco*[™] Gourmet Grill into your Non-combustible enclosure, complete the following steps:

1. Remove all packaging materials.
2. Ensure that the burners are positioned correctly on their orifices, and are fully seated onto their supports.
3. Position the briquette trays onto their support ledge.
4. Make the connection to the gas regulator according to the instructions on pages 8 through 11 for your gas type.
5. To comply with safety and service requirements, main gas shut off valve must be accessible from front of grill without using any tools.

CODE REQUIREMENTS:

When installing a grill or other gas appliance into an enclosure (island), the enclosure must be constructed with ventilation at both the top and bottom to avoid accumulation of gas should there be a leak.

Installation of this cooking appliance must be made in accordance with local codes. In the absence of local codes, this unit should be installed in accordance with the *National Fuel Gas Code No. Z223.1/ NFPA 54, Natural Gas and Propane Installation code CSA B149-1*, or *Propane Storage and Handling Code B149.2*.

All Electrical Components must be electrically grounded in accordance with local codes or in the absence of local codes with the *National Electrical Code ANSI/NFPA 70* or *Canadian Electrical code CSA C22.1*

Your *Alfresco*[™] Gourmet Grill has provision for mounting onto a mobile cart if you choose to do so.

Contact your *Alfresco*[™] dealer for the appropriate cart for your grill.

FREE STANDING MODELS:

Complete the following steps:

1. Remove all packaging materials.
2. Ensure that the burners are positioned correctly on their orifices, and are fully seated onto their supports.
3. Position the briquette trays onto their support ledge.
4. Make the connection to the gas regulator according to the instructions on pages 8 through 11 for your gas type.
5. Allow a minimum of 3" clearance around all sides of grill cart for proper air movement.
6. Lock the rear casters to prevent unwanted grill movement.

WARNING:

To prevent harm and ensure proper operation of your grill, it is imperative that the burners are properly installed with respect to the gas orifices. Be certain that the orifice is inserted completely into the burner's inlet and that the burner rests firmly on its support bracket.

The burner should not rock side-to-side nor top-to-bottom if properly installed. If excessive burner movement is present, reseal burner or contact your authorized service provider.

WARNING

IMPORTANT ELECTRICAL INSTRUCTIONS:

THE GRILL'S ROTISSERIE MOTOR AND LIGHTS ARE WIRED TO A SINGLE THREE-PRONG (GROUNDING) PLUG FOR YOUR PROTECTION AGAINST SHOCK HAZARD. THE GRILL SHOULD BE PLUGGED DIRECTLY INTO A PROPERLY GROUNDED GFCI THREE-PRONG RECEPTACLE.

AVERTISSEMENT

INSTRUCTIONS ÉLECTRIQUES IMPORTANTES:

LE MOTEUR ROTISSERIE DE GRILL ET LES LUMIÈRES SONT CÂBLÉES À UNE FICHE UNIQUE À TROIS PRONG POUR TU PROTECTION CONTRE LE DÉCHARGEMENT DES CHOCS. LE GRILLE DEVRAIT ÊTRE PLUGÉ DIRECTEMENT DANS UN RECEPTACLE GFCI TRES PRONG CORRECTEMENT TERRESTRE.

NE PAS COUPER OU RETIRER LE TERRAIN PRONG FROTH CETTE FICHE. GARDEZ LE CORDON ÉLEVÉ À PARTIR DE SURFACES DE GRILLE CHAUFFÉES. RETIRER LE MOTEUR QUAND IL N'EST PAS UTILISÉ

NOTES CONCERNING GFCI USE AND LOCATION:

1. Do not attempt to circumvent using a GFCI receptacle, it is for your safety.
2. Ensure that the GFCI receptacle is located in an easily accessed location.
3. Follow the manufacturer's instructions for installation and testing (must comply with local and national codes).

BRIQUETTE TRAY INSTALLATION:

Remove top grills.

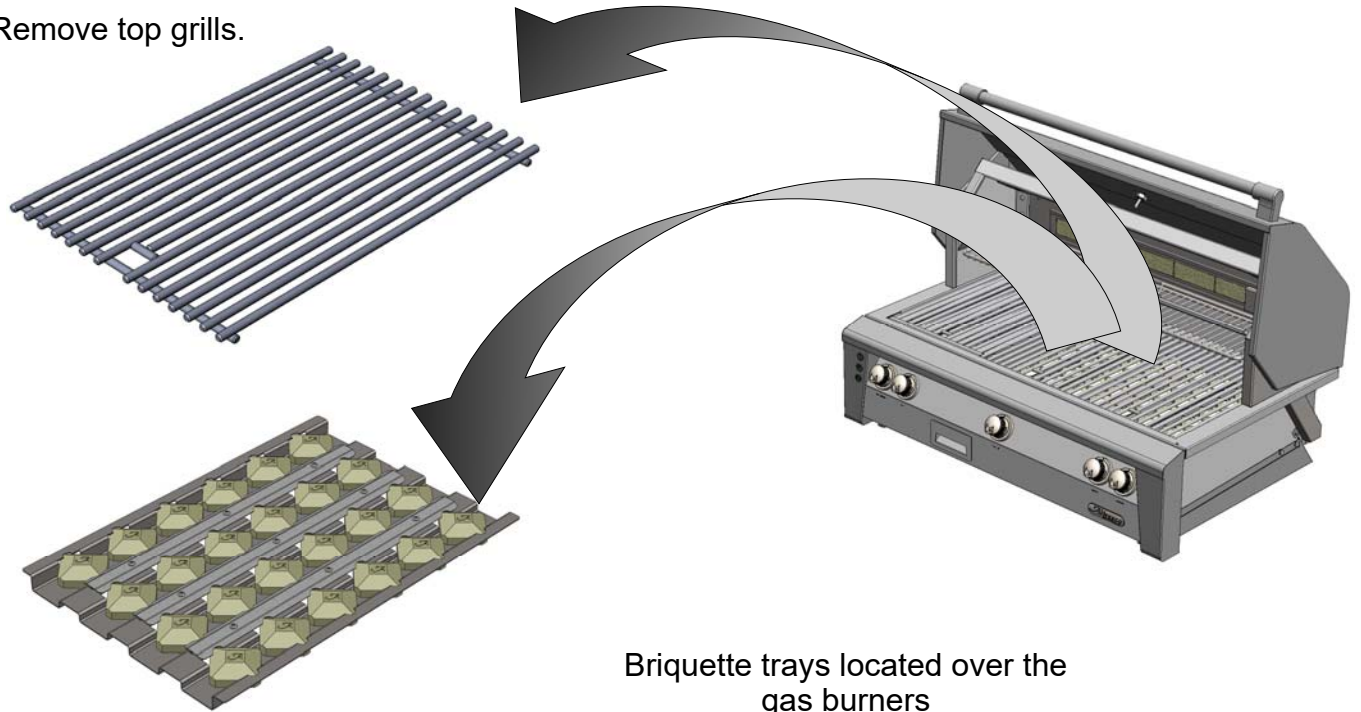

GAS CONNECTIONS:

NEVER CONNECT THE GRILL TO AN UNREGULATED GAS SUPPLY.

Total gas consumption (BTUH) with all burners set on "HI" is as follows:

MODEL:	LP GAS	NG GAS
ALXE-30SZ	63,100	64,200
ALXE-36SZ	82,000	85,800
ALXE-42SZ	84,200	88,200
ALXE-56SZ	122,000	124,000
ALXE-56BFG	116,900	122,900

LIQUID PROPANE (LP):

Before proceeding, ensure the unit is fitted for LP gas. Connecting to an improper gas type will result in poor performance and increased risk of damage or injury.

Installation of this cooking appliance must be made in accordance with local codes. In the absence of local codes, this unit should be installed in accordance with the *National Fuel Gas Code No. Z223.1/ NFPA 54, Natural Gas and Propane Installation code CSA B149-1*, or *Propane Storage and Handling Code B149.2*.

Manifold pressure with LP Operating: 10.0" W.C. Non-operating: 11.2" W.C.

L.P. TANK REQUIREMENTS:

Use only a standard 20 Lb. (5 Gal.) propane gas cylinder (18-1/4" H x 12-1/4" Ø). The tank must be installed in the upright position. Do not use a dented or rusty LP tank as it may be hazardous and should be checked by your LP supplier. Never use a cylinder with a damaged valve.

The LP gas cylinder must be constructed and marked in accordance with the specifications for LP gas cylinders of the U.S. Department of Transportation (DOT). The cylinder must be provided with a shut off valve terminating in an LP gas supply cylinder valve outlet specified, as applicable, for connection type **QCC1** in the standard for compressed gas cylinder valve outlet and inlet connections ANSI/CGA-V-I.

LP GAS CONNECTION TO LP TANKS:

Your *Alfresco*[™] Gourmet Grill for use with LP gas comes equipped with its own regulator, which **MUST NOT** be removed. There is also a secondary high capacity, hose/regulator assembly for connection to a standard 20 Lb. LP cylinder. The LP gas pressure regulator and hose supplied with this unit must be used without alteration.

If this assembly needs to be replaced use only the type specified by *Alfresco*[™] Gourmet Grill for this appliance. 30" grills require at minimum, a 90,000 BTUH regulator / hose assembly. All other sizes require at minimum, a 160,000 BTUH two-stage regulator / hose assembly.

To connect the regulator / hose assembly follow the next steps:

1. Locate the regulator and gas connection point in the rear right side of your BBQ unit (remove the rear panel from the BBQ cart to gain access - in cart mounted models).
2. Attach a 1/2" FPT x 1/2" MPT (male-to-female) elbow to the regulator (see figure # 2).
3. Fasten the hose connection to a 1/2" MPT x 3/8" COMP (compression flare fitting) connected to the elbow. (see figure # 2).

TYPICAL *Alfresco*[™] ALXE

CONVERTIBLE GAS PRESSURE
REGULATOR

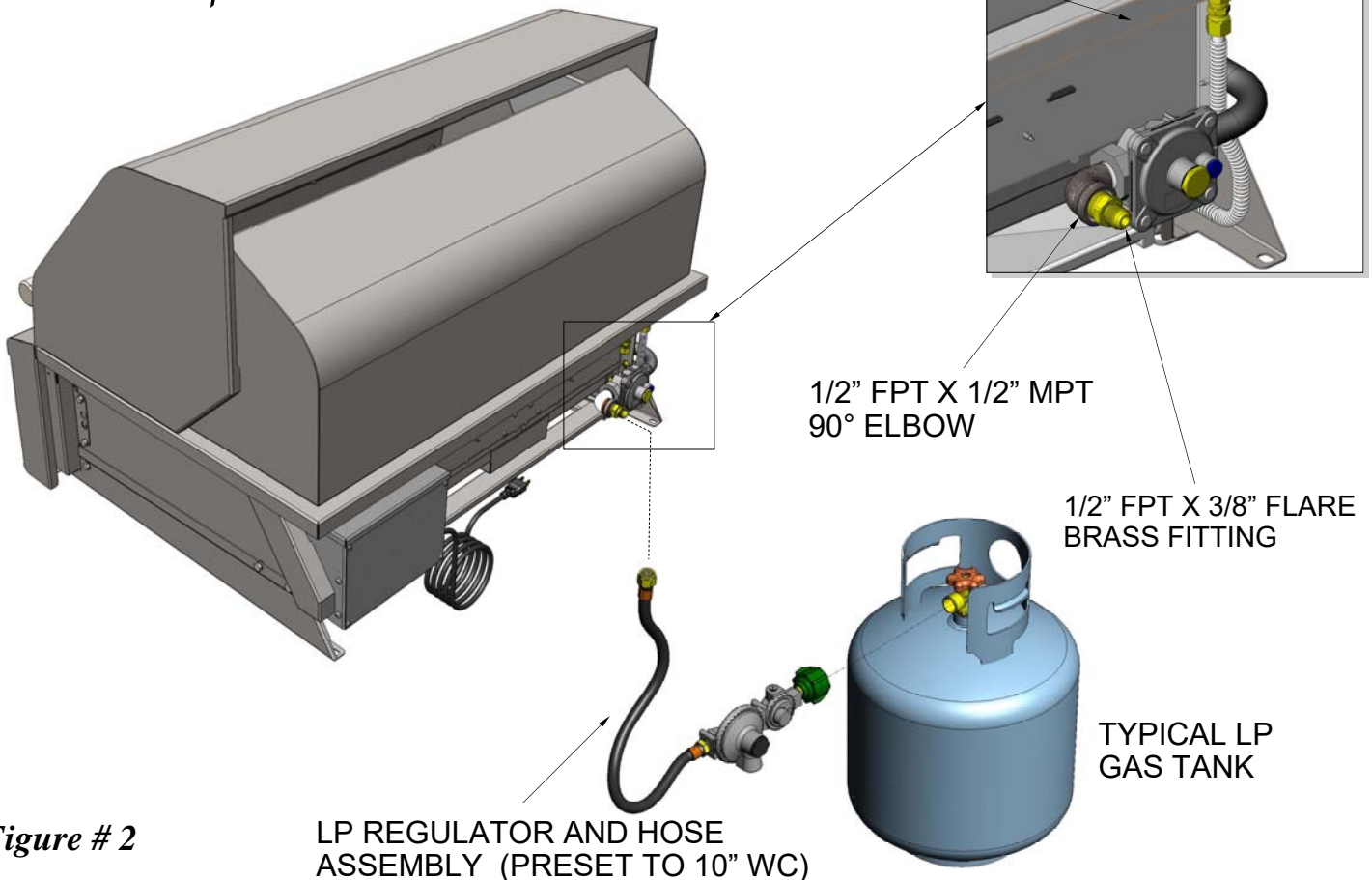

Figure # 2

⚠ WARNING

KEEP ANY ELECTRICAL CORD
AND FUEL SUPPLY HOSE AWAY
FROM ANY HEATED SURFACES.

⚠ AVERTISSEMENT

GARDER TOUT LE CORDON ÉLECTRIQUE ET LE
TUYAU D'ALIMENTATION DE CARBURANT À
L'ÉGARD DE TOUTES SURFACES CHAUF-
FANTES.

⚠ CAUTION

CYLINDERS MUST BE STORED OUTDOORS IN A WELL VENTILATED AREA OUT OF THE REACH OF CHILDREN.

DISCONNECTED LP CYLINDERS MUST HAVE THREADED VALVE PLUGS TIGHTLY INSTALLED, AND MUST NOT BE STORED IN A BUILDING, GARAGE OR ANY OTHER ENCLOSED AREA. THE GAS MUST BE TURNED OFF AT THE SUPPLY CYLINDER WHEN THE UNIT IS NOT IN USE. IF THE APPLIANCE IS STORED INDOORS, THE CYLINDER MUST BE DISCONNECTED AND REMOVED FROM THE APPLIANCE.

⚠ MISE EN GARDE

LE CYLINDRE DOIT ÊTRE STOCKÉ À L'EXTÉRIEUR DANS UN ENDROIT BIEN VENTILÉ ET HORS DE LA PORTÉE DES ENFANTS.

DÉBRANCHER LES BOUTEILLES DE LP DOIVENT AVOIR DES BOUCHONS DE VALEUR VISSÉS HERMÉTIQUEMENT INSTALLÉS, ET NE DOIVENT PAS ÊTRE STOCKÉS DANS UN BÂTIMENT, GARAGE OU TOUT AUTRE ESPACE FERMÉ. LE GAZ DOIT ÊTRE ARRÊTÉ AU NIVEAU DU CYLINDRE D'ALIMENTATION LORSQUE L'APPAREIL N'EST PAS UTILISÉ. SI L'APPAREIL EST ENTREPOSÉ À L'INTÉRIEUR, LE CYLINDRE DOIT ÊTRE DÉBRANCHÉ ET RETIRÉ DE L'APPAREIL.

⚠ WARNING

YOUR ALFRESCO™ GOURMET GRILL'S PRESSURE REGULATOR HAS A **MAXIMUM INPUT PRESSURE OF 14" WC.** (OR APPROX. .5 PSI) , AND A **SAFETY LIMIT OF 69" WC.** (2.5 PSI).

⚠ AVERTISSEMENT

VOTRE RÉGULATEUR DE PRESSION ALFRESCO GOURMET GRILLADES A **UNE PRESSION D'ENTRÉE MAXIMALE DE 14" WC** (OU ENVIRON 0,5 PSI), ET **UNE LIMITE DE SÉCURITÉ DE 69" WC (2,5 PSI).**

⚠ REGULATOR NOTICE

Exposure to pressures above the safety limit of 69" WC. will permanently damage the gas regulator requiring a replacement.

OVER PRESSURE DAMAGE IS NOT COVERED BY YOUR ALFRESCO WARRANTY

LP GAS CONNECTION TO LP PIPED SYSTEMS:

An LP piped system is one with a large central LP tank that feeds the entire household. Those systems are normally equipped with a high pressure regulator by the large LP tank and low pressure regulators close to the home.

For this type of installation:

- **DO NOT** use the LP small tank regulator supplied with the unit shown in Figure # 2.
- Connect the gas line for this type of installation directly to the unit's convertible gas pressure regulator in similar fashion as the NG gas connection (Figure # 3) using a flexible hose connected to a required gas shut-off valve.
- **NOTE:** The convertible gas pressure regulator must be set for LP gas. (Factory pre-set in LP units).

The gas line connectors must comply with the *Standard for Connectors for Outdoor Gas Appliances and Manufactured Homes, ANSI Z21.75 • CAS 6.27*, and suitable for outside installation. The maximum length of the connection shall be 6 Ft. (1.82 m)

GAS CONNECTION - NATURAL GAS (NG)

NEVER CONNECT THE GRILL TO AN UNREGULATED GAS SUPPLY.

Before proceeding, ensure the unit is fitted for natural gas. Connecting to an improper gas type will result in poor performance and increased risk of damage or injury. Installation of this cooking appliance must be made in accordance with local codes. In the absence of local codes, this unit should be installed in accordance with the *National Fuel Gas Code No. Z223.1/ NFPA 54, Natural Gas and Propane Installation code CSA B149-1* , or *Propane Storage and Handling Code B149.2*.

Manifold pressure with NG: Operating: 4.0" W.C. (.14 PSI) Non-operating: 4.5" W.C. (.16 PSI)

NOTE: To ensure proper heating performance of this appliance, verify that the gas line supply pressure is adequate (7.0" W.C. supply pressure is preferred) to maintain 4.5" W.C. manifold pressure. Use a minimum 1/2" ID flex hose to prevent gas starvation.

NATURAL GAS CONNECTION:

Ensure that the service pipe supplying the Grill is fitted with a shut off valve conveniently positioned and easily accessible as an emergency gas shutoff.

Your *Alfresco*[™] Gourmet Grill for use with natural gas comes equipped with its own regulator which **MUST NOT** be removed.

If this regulator needs to be replaced use only the type specified by *Alfresco*[™] Gourmet Grill for this appliance.

To connect the regulator / hose assembly follow the next steps:

1. Locate the regulator and gas connection point in the rear right side of your BBQ unit (remove the rear panel from the BBQ cart to gain access - in cart mounted models).
2. Attach a 1/2" FPT x 1/2" MPT (male-to-female) elbow to the regulator (see figure # 3).
3. Fasten the hose connection to a 1/2" MPT x 3/8" COMP (compression flare fitting) connected to the elbow. (see figure # 3).

Connect flare fitting to gas supply using a 1/2" Ø minimum flexible (semi-rigid) stainless steel gas hose, no more than 48" in length. The hose as well as the connectors must comply with the *Standard for Connectors for Outdoor Gas Appliances and Manufactured Homes, ANSI Z21.75 • CAS 6.27.*

TYPICAL *Alfresco*[™] ALXE
BBQ (36" MODEL SHOWN)

CONVERTIBLE GAS PRESSURE
REGULATOR

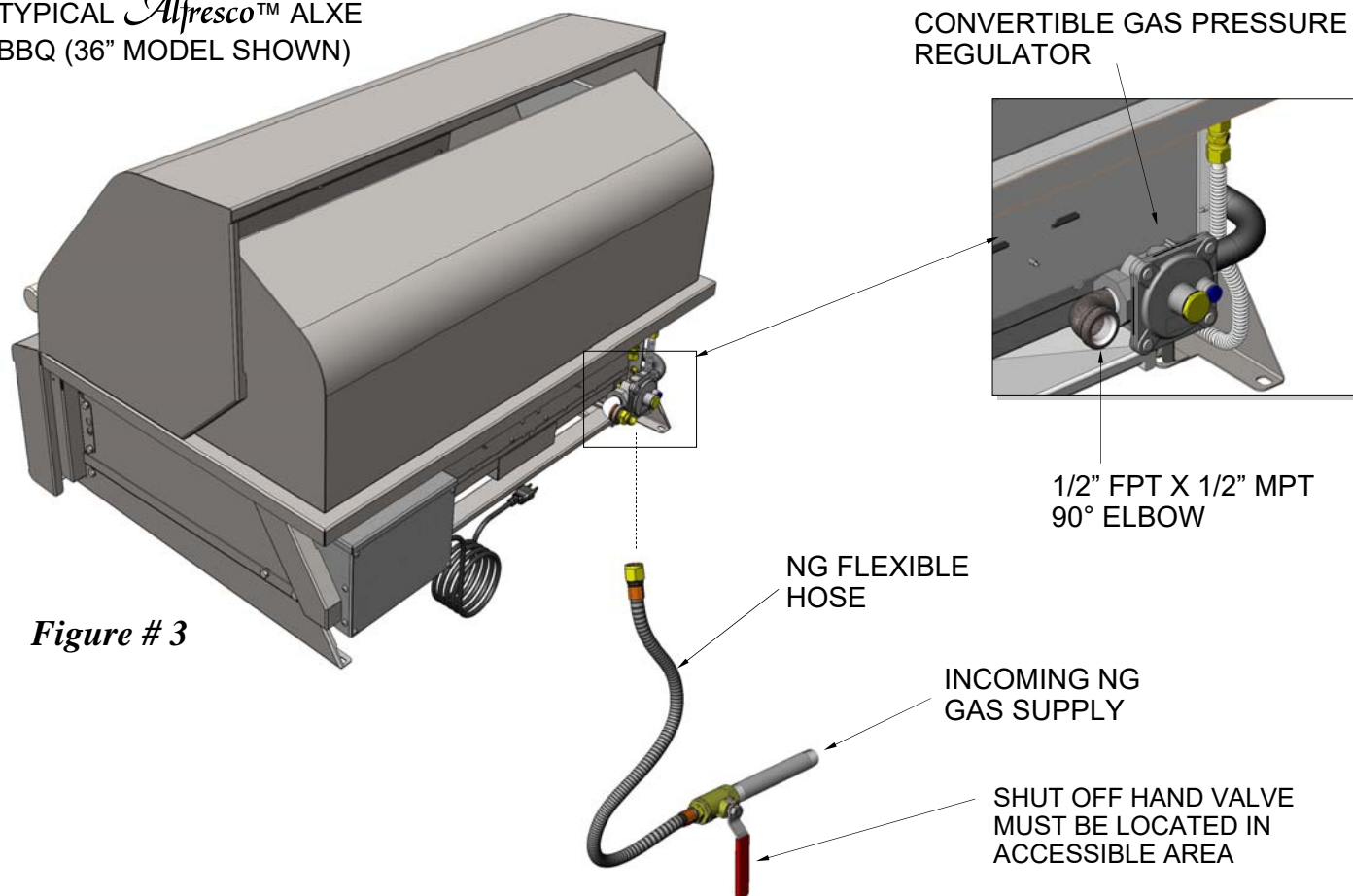

Figure # 3

LEAK TESTING:

GENERAL:

Although all gas connections on your *Alfresco*[™] Gourmet Grill are leak tested at the factory prior to shipment, a complete gas tightness check must be performed at the installation site due to possible mishandling in shipment, or excessive pressure unknowingly being applied to the unit. Periodically check the whole system for leaks, or immediately check if the smell of gas is detected.

BEFORE TESTING:

- Do not smoke while leak testing.
- Never leak test with an open flame.
- Make a soap solution of one part liquid detergent and one part water for leak testing purposes.
- Apply the solution to the gas fittings by using a spray bottle, or brush.
- For LP units, always check with a full cylinder.

TO TEST:

- Make sure all control valves are in the “OFF” position.
- Apply the soap solution described above to all fittings.
- Turn the gas supply on.
- Check all connections from the supply line, or LP cylinder up to and including the manifold pipe assembly.
- Soap bubbles will appear where a leak is present.
- If a leak is present, immediately turn off gas supply, tighten any leaking fittings, turn the gas supply back on, and recheck.
- If you cannot stop a gas leak turn off the gas supply and call your dealer where you purchased your grill.
- Do not use the grill until all connections have been checked and do not leak.

IMPORTANT NOTE:

ALWAYS CHECK FOR LEAKS AFTER EVERY LP TANK CHANGE.

If a leak is present, or if the connection hose shows signs of wear, these conditions must be corrected prior to using your grill. If it is evident there is excessive abrasion or wear, or the hose is cut, it must be replaced prior to the cooking appliance is being put into operation.

The replacement hose assembly is part number: **PROP-KIT-01** which consists of a 36” long hose assembly with dual in-line regulator and a 3/8” ODF connector.

Contact *Alfresco*[™] Grills for replacement.

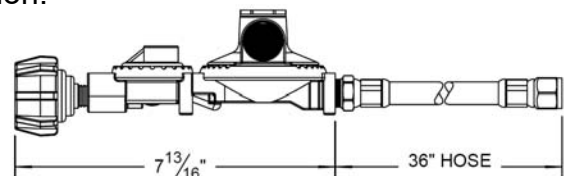

Check all gas supply fittings for leaks before each use. It is handy to keep a spray bottle of soapy water near the shut-off valve of the gas supply line. Spray all the fittings. Bubbles indicate leaks.

LIGHTING INSTRUCTIONS:

BEFORE LIGHTING...

The pressure regulator and hose assembly supplied with the unit must be used. Never substitute regulators for those supplied with the grill. If a replacement is necessary, contact the factory for proper replacement.

Screw the regulator (**Type QCC1**) onto the LP tank. Leak check the hose and regulator connections with a soap and water solution before operating as explained on the LEAK TESTING section of this manual.

⚠ WARNING

HOOD MUST BE OPEN WHEN LIGHTING THE GRILL.

HOOD SHOULD NOT BE CLOSED FOR LONG PERIODS WHEN IR BURNERS ARE IN USE.

⚠ WARNING

DO NOT ATTEMPT TO LIGHT THE GRILL IF THE ODOR OF GAS IS PRESENT.

⚠ AVERTISSEMENT

LE CAPOT DOIT ÊTRE OUVERT LORSQUE L'ALLUMAGE DE LA HOTTE DU GRIL.

NE DOIT PAS ÊTRE FERMÉ PENDANT DE LONGUES PÉRIODES LORSQUE DES BRÛLEURS IR SONT UTILISÉS.

⚠ AVERTISSEMENT

N'ESSAYEZ PAS D'ALLUMER LE GRIL SI L'ODEUR DE GAZ EST PRÉSENTE.

BUTTON SYMBOLS AND LOCATIONS:



IGNITER BUTTON SWITCH
(on the TOP)



LIGHT FIXTURES SWITCH
(in the MIDDLE)



ROTISSERIE SWITCH
(at the BOTTOM)

To ensure that an IR burner is lit, very carefully place your hand 8-10 inches away from the burner surface. If you do not feel the heat of the burner, shut off the gas at the control knob, wait five minutes, and then try again.

LIGHTING THE GRILL'S U-BURNER , SMOKER AND SEAR-ZONE™ BURNERS:

Turn all knobs to "OFF" and then turn on the gas supply.

Adjustable valves are labeled **OFF MAX ► MIN**. Non adjustable valves are labeled **OFF ON**.

Always keep your face and body as far away from the grill as possible when lighting!

Lift the hood, depress the igniter button (see above symbol) and for the burner you are trying to light, immediately push and turn the burner control knob 90° counter-clockwise to:

- "MAX" position (U-Burners and Smoker) or
- "ON" position (Sear-Zone™).

Wait for the burner to light. Adjust the temperature by turning the knob from **MAX** (high setting) to **MIN** (low setting) by turning counter clock-wise.

NOTE: The first burner may take longer to light while air is purged from the gas supply system. If the burner does not light within 4 seconds, turn knobs to "OFF" and wait 5 minutes to allow any accumulated gas to dissipate before trying again.

LIGHTING SIDE BURNERS (MODELS ALXE-56 & 56 SZ):

FRONT BURNER: Push and turn the side burner right hand control knob 90° counter-clockwise to the "MAX" position and immediately depress the right hand igniter button. You'll hear a snapping sound from the spark which will be provided to both side burners. It is necessary to keep the igniter button depressed until the burner is lit.

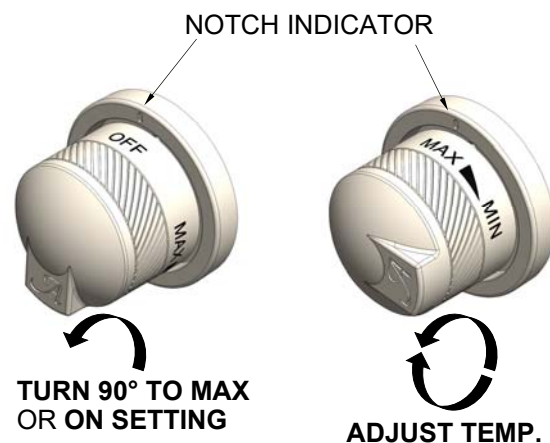

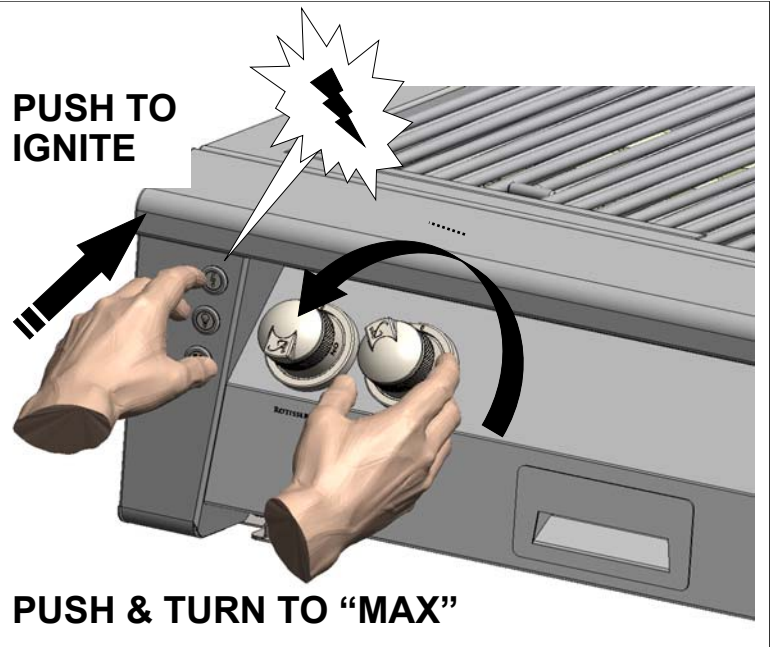
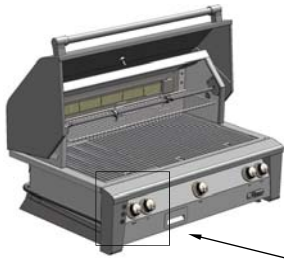

REAR BURNER: Repeat the same operation as explained on the front burner but using the side burner left hand control knob.

If either burner does not light within 4 seconds, turn knob to **"OFF"** and wait 5 minutes to allow any accumulated gas to dissipate before trying again.

NOTE: To ensure proper spark ignition, do not change the gap between the electrode wires and the burners. The optimum gap is preset at the factory between 1/8" and 3/16".

ROTISSERIE BURNER LIGHTING:

Open the hood, press the proper igniter button (see previous page) and then turn the control knob 90° counter-clockwise to the **"ON"** position. If the burner does not light within 4 seconds, turn the control knob to **"OFF"**, wait five minutes and attempt to relight.

After your first use of the rotisserie burner it is likely that the stainless steel adjacent and directly above the burner will darken to a dark blue color. This is a normal property of the corrosion resistant type 304 stainless steel used in manufacturing the Grill and is not detrimental to its operation.

⚠ CAUTION
IN SUNNY ENVIRONMENTS, THE FLAME FROM AN IR BURNER MAY BE IMPOSSIBLE TO SEE.

⚠ MISE EN GARDE
DANS LES ENVIRONNEMENTS SOLEILS, LA FLAMME D'UN BRÛLEUR IR PEUT ÊTRE IMPOSSIBLE À VOIR.

PREHEATING THE GRILL:

U-BURNERS:

Preheating the grill is important for best performance. To preheat the grill when cooking with the U-burners, close the hood after lighting the burners as described above. Set the grill control knobs on **"MAX"** for 15 minutes.

IR-BURNERS:

Preheating the IR burners is important to protect them from food drippings. After lighting the IR burners as described above, allow to preheat on **"ON"** for four minutes before beginning to grill. If your grill is equipped with a SEAR-ZONE™ IR BURNER, light and preheat the U-BURNERS first, then light and preheat the SEAR-ZONE™ IR BURNER.

ROTISSERIE BURNER:

Light the rotisserie burner as described in the lighting instructions. Once lit, the rotisserie burner will reach cooking temperatures in about 1 minute.

BURNER ADJUSTMENTS:

NOTE: *Alfresco* grills are available with both U-burners and IR burners. The following instructions apply only to the U-burners. IR burners do not require adjustment and need only be checked visually for proper performance. On high, an IR burner should glow red evenly over its entire surface.

U-BURNER AIR ADJUSTMENT:

Each grill burner is tested and adjusted at the factory prior to shipment; however, variations in the local gas supply, elevation and other factors might make it necessary to adjust the burners. The flames of the burners should be visually checked and compared with Figure 4.

If any of these conditions exist, check if dirt, debris, spider webs, etc., are blocking the air shutter or burner ports. Proceed with air shutter adjustment.

AIR SHUTTER ADJUSTMENT:

A sheet metal cap at the inlet of the burner called the “AIR SHUTTER” regulates the amount of air that enters into the burner for combustion.

The air shutter is locked in place by a screw, which must be loosened prior to lighting the burner for adjustment. The air shutter adjustment screws are accessible with a screwdriver by removing the burner. Loosen the screw of the air shutter. Reinstall the burner. Make certain that the burners are sitting properly on the orifices taking care not to move or damage the igniter electrode.

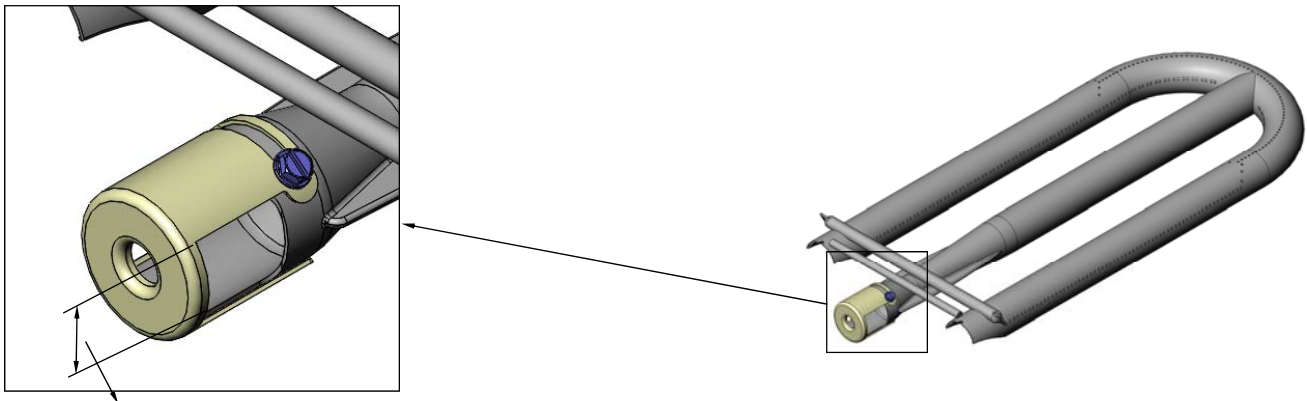

AIR SHUTTER APPERTURE IS FACTORY SET TO APPROXIMATELY 1/2” FOR LP & 5/8” FOR NG - MINOR ADJUSTMENTS MAY BE NECESSARY DUE TO FACTORS SUCH AS HIGH ALTITUDE LOCATIONS.

Light the burners and adjust according to the following directions:

- Turn the valve on “HI”, light the burner and allow it to “WARM UP” for 10 minutes.
- If the flame is yellow, indicating insufficient air, turn the air shutter counter-clockwise to allow more air to the burner. *Caution, see note below.
- If the flame is noisy and tends to lift away from the burner, (*WITH THE BRIQUETTE TRAYS IN POSITION*) indicating too much air, turn the air shutter clockwise to reduce the amount of air to the burner.
- Retighten the locking screw of the air shutter cap.

***NOTE:** Be careful, as the burner may be or will become very hot after lighting it.

Flames should be blue and stable with no yellow tips, excessive noise or lifting.

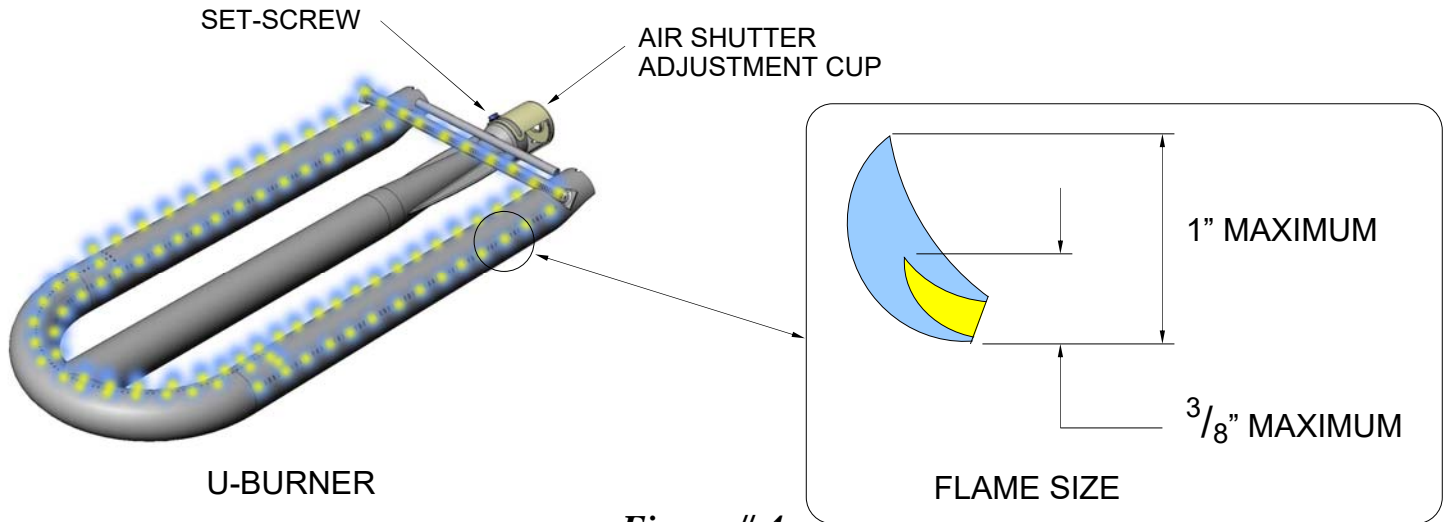

Figure # 4

LOW HEAT SETTING ADJUSTMENT:

NOTE:

THE LOW HEAT SETTING ON YOUR GRILL IS PRESET AT THE FACTORY. ADJUST ONLY IF ALTITUDE OR ENVIRONMENTAL FACTORS ARE CAUSING POOR, LOW HEAT, PERFORMANCE.

⚠ WARNING

NEVER ADJUST THE BURNER SO LOW THAT IT MAY GO OUT DURING USE. DO NOT OPERATE THE GRILL WITH THE LOW HEAT SCREW REMOVED.

GAS CAN ESCAPE AND CAUSE A POTENTIALLY HAZARDOUS CONDITION.

⚠ AVERTISSEMENT

NE JAMAIS AJUSTER LE BRÛLEUR SI BAS QU'IL PEUT S'ÉTEINDRE PENDANT L'UTILISATION. N'UTILISEZ PAS LE GRIL AVEC LA VIS À CHALEUR BASSE RETIRÉE.

LE GAZ PEUT S'ÉCHAPPER ET PROVOQUER UNE CONDITION POTENTIELLEMENT DANGEREUSE.

ADJUSTMENT STEPS:

1. Follow lighting instructions by setting the control knob on "HI" and allow the burner to preheat for 10 minutes.
2. Turn the control knob to "LOW" and wait for the burner temperature to drop and stabilize.
3. **Attempting adjustment at any setting other than LOW can create a dangerous condition.**
4. Remove knob by pulling straight away from control panel.
5. Insert a small blade screwdriver into the valve stem to begin the adjustment. (see figure # 5)
6. Turn counter-clockwise to INCREASE the low heat flame while using pliers to hold the stem securely.
7. Adjust the flames so the burner is fully lit around the perimeter when the knob is in the LOW position. Once proper adjustment is reached, reattach the knob by pushing onto stem.

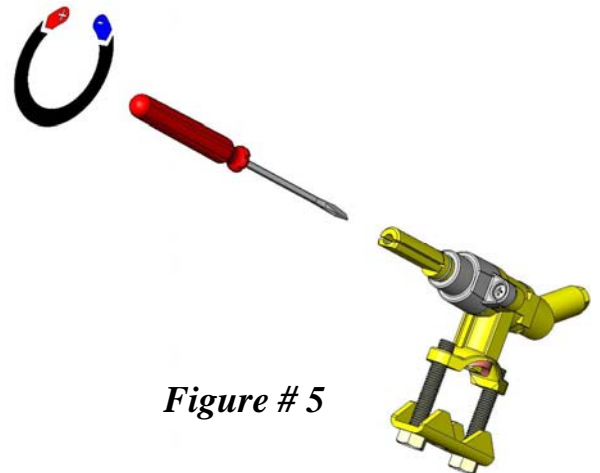

OPERATING THE GRILL:

U-BURNERS:

Each U-burner is rated at 27,500 BTU. (See figure # 6).

The grill burners encompass the entire cooking area and are side ported to minimize blockage from falling grease and debris.

Above the burners there are stainless steel briquette trays with ceramic briquettes. The briquette tray is a fundamental part for the performance of the grill. Do not cook on the grill without them.

Make sure the briquette tray is installed properly before lighting the burner. Each grill burner has its own igniter.

The burners are locked in the proper position within the barbecue unit by the inlet port where the valve orifice stem is located, the shutter adjustment screw notch and the rear mounting bracket at the back of the grill cavity. (See figure # 6a)

Figure # 6

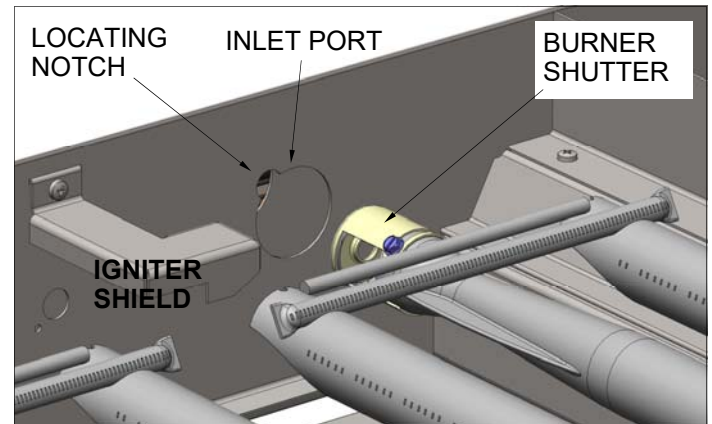
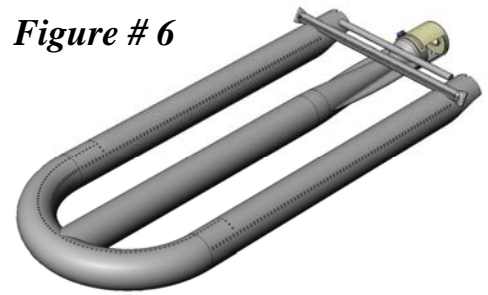

Figure # 6a

USING THE GRILL:

Grilling requires high heat for searing and proper browning. Most foods are cooked at the “HI” heat setting for the entire cooking time. However, when grilling large pieces of meat or poultry, it may be necessary to turn the heat to a lower setting after the initial browning. This method will cook the food through without burning the outside. Foods cooked for a long time or basted with a sugary marinade may need a lower heat setting near the end of the cooking time.

NOTE: The hot grill sears the food, sealing in the juices. The longer the preheat period, the faster the meat browns and the darker the sear marks. Place the food on the grill and cook to the desired brown level. Adjust heat setting, if necessary. The control knob may be set to any position between “HI” and “LOW”. **DO NOT** leave the grill unattended while cooking.

SEAR-ZONE™ - IR BURNERS:

Each U-burner is rated at 27,500 BTU. (See figure # 7).

An IR grill works by producing intense heat which quickly sears the meat. Searing locks in flavor and juices while allowing the outer surface to absorb smoke and food aroma that is produced as grease and drippings are vaporized by the burner. The result is a crisp, flavorful outside with a tender, juicy inside. Just the result you want with most grilled foods. Sear-Zone™ burners are located in their proper position by the inlet port and the rear bracket support of the burner area.

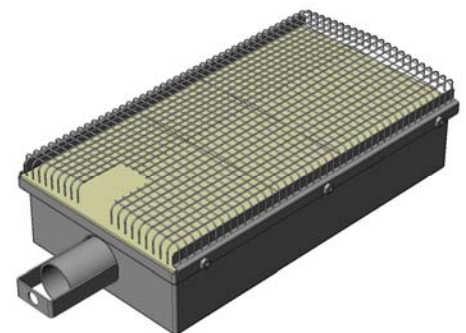

Figure # 7

USING THE GRILL:

Grilling requires high heat for searing and proper browning. The intense infrared heat produced by your *Alfresco*™ Gourmet Grill meets these requirements perfectly. Meat is cooked evenly throughout, while juices, grease and food particles are vaporized upon contact with the burner, giving added flavor to your food.

NOTE: The hot grill sears the food, sealing in the juices. Proper preheating browns the meat and produces darker sear marks. Place the food on the grill and sear both sides as recommended on the “Infrared Grilling Tips” section on page 19. **DO NOT** leave the grill unattended while cooking.

ROTISSERIE BURNERS:

Your *Alfresco*™ Gourmet Grill is capable of performing back burner rotisserie cooking. The location of the rear burner allows the placement of the rotisserie basting pan (included) beneath the food to collect juices and drippings for basting and gravy. To flavor the contents of the basting pan, you can add herbs, onion, garlic, or spices.

 **NOTICE**

AVOID WATER DAMAGE TO BURNER NEVER ALLOW WATER TO CONTACT THE IR BURNER AS DAMAGE TO THE CERAMIC PANEL WILL RESULT.

WATER DAMAGE IS NOT COVERED BY YOUR ALFRESCO WARRANTY

To assure that an IR burner is lit, very carefully place your hand 8-10 inches away from the burner surface. If you do not feel the heat of the burner, shut off control knob, wait five minutes, and attempt to re-light.

ROTISSERIE MOTOR:

The rotisserie motor is capable of turning up to a 50 Lb. cut of meat or poultry, with a maximum diameter of 12". The rotisserie motor is an integral part of the grill, mounted on the rear bottom of the unit. The motor drives a chain and sprocket system to a skewer coupler located your upper cooking area.

The rotisserie motor is electrically grounded by the grill electrical system and plug, therefore the grill must installed in accordance with local codes or, in the absence of local codes, with the National Electrical Code, ANSI/NFPA 70-1990.

SKEWER:

The skewer for the rotisserie is assembled into the skewer coupler (located right side of the grill) by placing the pointed end into the square opening of the coupler. The other end of the skewer (round shaft end) rests between the rotisserie bearing wheels opposite to the skewer coupler, on the left side of the grill.

To load the skewer, slide the meat holders with the prongs facing towards the center the skewer bar. Push the skewer through the center of the food, and then slide the second meat holder (prongs toward the food) onto the skewer.

Center the product to be cooked on the skewer then push the meat holders firmly together. Tighten the thumb nuts of the meat holders with pliers. It may also be necessary to wrap the food with butcher's string (never use nylon or plastic string) to secure any loose portions. Once the food is secure, insert the skewer into the coupler. Start the motor with the switch located on the right side of the control panel.

ROTISSERIE BASTING PAN:

Your *Alfresco*™ Gourmet Grill includes a basting pan for use with the rotisserie. Place the pan onto the grill racks (or, if necessary, directly onto the briquettes if the grill racks are removed to accommodate large cuts of meat). This pan will catch drippings from the meat being cooked, preventing grease build-up on the briquettes or Sear-Zone™ IR Burner.

 **NOTICE**

ALWAYS USE BASTING PAN WITH ROTISSERIE TO KEEP DRIPPINGS OFF BURNERS AND BRIQUETTES.

DO NOT USE WHILE GRILLING.

NOTE: Never use the basting pan when any of the grill burners are lit. Basting pan is for use with the rotisserie burner only.

ROTISSERIE GENERAL COOKING INSTRUCTIONS:

As a general rule, rotisserie cooking will take 15 ~ 20 minutes per pound of meat. Keep the hood closed as much as possible to improve performance.

INFRARED GRILLING TIPS:

Even for an experienced chef, infrared cooking can, at first, present a bit of a challenge. By following these simple tips, you will soon be producing juicier, more flavorful foods than you have ever experienced before. As a general rule, foods will cook in less time than they would take on an ordinary grill.

By turning food frequently (approximately every 2 minutes), excessive charring is simply avoided.

ALFRESCO RECOMMENDS THAT YOU TURN FOOD BEING GRILLED ON A SEAR ZONE™ IR-BURNER EVERY TWO MINUTES DURING THE COOKING PERIOD. NEVER ALLOW FOOD TO COOK MORE THAN 2 1/2 MINUTES WITHOUT TURNING.

SEARING IS THE KEY:

An infrared grill works by producing intense heat which quickly sears meats. Searing locks in flavor and juices while allowing the outer surface to absorb smoke and food aroma that is produced as grease and drippings are vaporized by the burner. The result is a crisp, flavorful outside with a tender, juicy inside. Just the result you want with most grilled foods.

HOW TO GRILL WITH IR:

Properly pre-heat the grill by following the lighting instructions on page 12. Place food on grill grids and turn every 2 to 2 1/2 minutes until food is cooked to desired taste. Do not let food cook more than 2 1/2 minutes without turning. Perfect cross sear marks can be made by rotating food 90° at each turn.

APPROXIMATE SEAR-ZONE™ COOKING TIMES:

FOOD ITEM	APPROXIMATE COOKING TIME (MINUTES) ❖		
	RARE	MEDIUM	WELL
HAMBURGER -1/2" THICK	4	5	6
STEAK - 1" THICK"	6	8	10
CHICKEN BREAST (BONELESS)	8 ~ 10		
CHICKEN BREAST (BONE-IN)	20 ~ 24		

❖ These are recommended times only. Due to the variations on the cuts of meats and personal taste, your cooking times may be different. Use your discretion when cooking with ALFRESCO™ Gourmet Grill Sear-Zone™ IR-Burners.

WOOD CHIP SMOKER:

By using real wood chips in the smoker system of your *Alfresco*™ Gourmet Grill, you can add extra flavor to all of your grilled foods. For good smoke performance, soak the wood chips for not less than 30 minutes, drain excess liquid and fill the smoker tray completely.

HOW TO SMOKE:

1. Fill the smoker tray with thoroughly soaked and drained wood chips.
2. Light the smoker burner according to the instructions on page 12.

Replace the smoker tray into the grill, close the hood and set the smoker burner to high. Smoke should begin in about 20 ~ 30 minutes

One tray of wood chips will usually last about one hour. During extended grilling, chips may need to be added several times. Pull the drawer only partially out of the grill to add chips while in use. Never remove the hot smoker tray completely from the grill. To improve smoke performance, keep the hood closed as much as possible while food is grilling.

NOTE: If not thoroughly soaked, the wood chips will flare up during grilling. To extinguish flames, pull the drawer slowly a few inches out of the grill front and add a small amount of water. The smoker tray can also be filled with water to produce steam which can help keep delicate foods moist during grilling.

TYPES OF WOOD CHIPS TO USE:

- **Alder:** Medium, tart smoke flavor. Excellent on fish, chicken or game.
- **Maple:** Sweet, hearty smoke flavor. Best with fish, jerky or bacon.
- **Apple:** Light, sweet smoke flavor. Superb with poultry, ham or sausage.
- **Hickory:** Heavy smoke flavor. Best with beef, pork or game.
- **Mesquite:** Light smoke flavor. Excellent on fish, poultry or beef.
- **Oak:** Heavy smoke flavor. Best with beef, lamb or pork.
- **Pecan:** Rich, sweet, versatile flavor. Good with any grilled foods.
- **Grapevine:** Strong smoke flavor. Best with beef or poultry.

STEAMER / FRYER (OPTIONAL EQUIPMENT):

This optional accessory brings a new level of versatility to your grill, enabling you to deep fry, steam or boil foods on one side of your *Alfresco*™ Gourmet Grill while grilling on the other. To ensure safe operation and quality results, please follow these instructions:

NOTE: NEVER USE THIS ACCESSORY OVER A SEAR-ZONE™ IR-BURNER.

TO STEAM:

1. Remove the right grate and place the Steamer/Fryer into the grill as shown left. (*figure # 8*)
2. Insert the steaming plate into the Steamer/Fryer, and add water to just below the level of the steaming plate. Be careful not to spill water onto the burner as damage will result.
3. Place lid onto Steamer/Fryer.
4. Follow lighting instructions on page 12 and bring water to a boil.
5. Reduce heat, remove lid and add food to be steamed.

When food is cooked to your desired taste, carefully remove the lid and remove food from Steamer/Fryer with long-handled tongs or a slotted spoon.

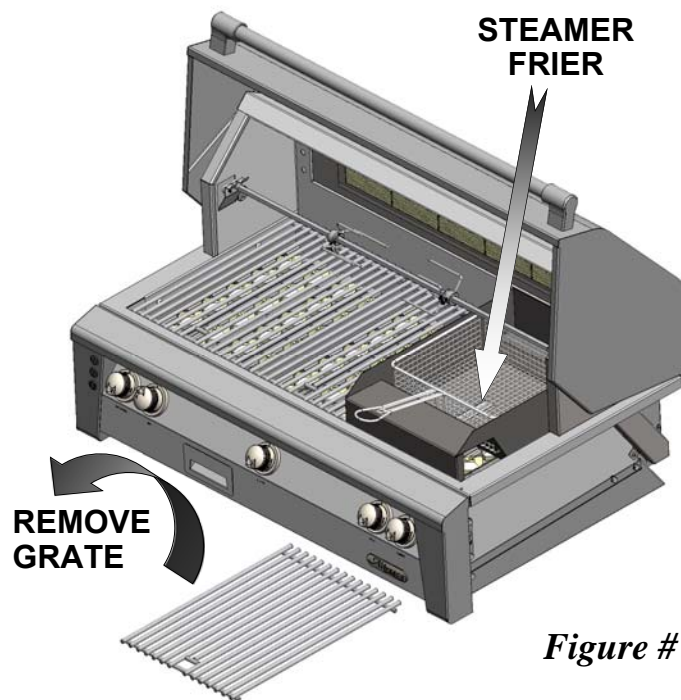

Figure # 8

NEVER ATTEMPT TO REMOVE THIS ACCESSORY FROM THE GRILL WHEN HOT. ALLOW TO COOL COMPLETELY BEFORE MOVING OR CLEANING.

TO BOIL:

Follow instructions for steaming but leave the steaming plate out. Add as much water as necessary to cover the foods being cooked, but never fill the Steamer/Fryer more than halfway.

TO FRY:

1. Remove the right grate and place the Steamer/Fryer into the grill as shown above.
2. Fill the Steamer/Fryer no more than one-third full with oil. Be careful not to spill oil onto the burner as damage and / or fire will result.
3. Follow lighting instructions on page 12. Allow grill to preheat for no more than three minutes, then reduce heat to no more than medium. Use an appropriate thermometer to bring oil to proper frying temperature, usually between 350 °F ~ 375 °F.
4. Place the frying basket into the oil. Carefully add food one piece at a time using long-handled tongs.
5. After food has fried for sufficient time, lift the entire frying basket out of the oil and allow it to drain. Remove food to an appropriate vessel and return the frying basket to the oil. Repeat as needed.

When finished frying, turn off heat and allow the grill, Steamer/Fryer and oil to cool completely before attempting to remove unit. Dispose of used cooking oil appropriately.

NOTE: DO NOT USE LID WHEN FRYING. USE THE LID WHILE STEAMING OR BOILING ONLY. USE ALWAYS THE MINIMUM HEAT SETTING NECESSARY TO MAINTAIN THE PROPER FRYING TEMPERATURE.

⚠ WARNING

HOT OIL AND STEAM CAN BE DANGEROUS

ALWAYS WEAR OVEN MITTS WHEN USING THIS ACCESSORY. ALLOW UNIT TO COOL COMPLETELY BEFORE REMOVING. OIL CAN CATCH FIRE IF OVERHEATED.

NEVER USE THE FRYER WITH A BURNER SET TO HIGH. IF OIL BEGINS TO SMOKE, IMMEDIATELY REDUCE HEAT. IN CASE OF FIRE, TURN BURNER OFF AND EXTINGUISH WITH A CLASS A,B,C OR D FIRE EXTINGUISHER.

NEVER PUT WATER ON HOT OR FLAMING OIL!

⚠ AVERTISSEMENT

L'HUILE CHAUDE ET LA VAPEUR PEUVENT ÊTRE DANGEREUSES

TOUJOURS PORTER DES GANTS DE CUISINE LORSQUE VOUS UTILISEZ CET ACCESSOIRE. LAISSEZ L'APPAREIL REFROIDIR COMPLÈTEMENT AVANT DE LE RETIRER. L'HUILE PEUT S'ENFLAMMER SI ELLE EST SURCHAUFFÉE.

NE JAMAIS UTILISER LA FRITEUSE AVEC UN BRÛLEUR RÉGLÉ SUR HAUT. SI L'HUILE COMMENCE À FUMER, RÉDUIRE IMMÉDIATEMENT LA CHALEUR. EN CAS D'INCENDIE, ÉTEINDRE LE BRÛLEUR ET L'ÉTEINDRE AVEC UN EXTINCTEUR DE CLASSE A, B, C OU D.

NE METTEZ JAMAIS D'EAU SUR DE L'HUILE CHAUDE OU FLAMMING!

⚠ NOTICE

DO NOT CLOSE THE GRILL HOOD WHEN USING THIS ACCESSORY.

DO NOT USE THIS ACCESSORY IN COMBINATION WITH THE GRIDDLE, OR ANY OTHER ACCESSORY THAT WOULD RESULT IN MORE THAN 75% COVERAGE OF THE GRILLING AREA.

OVERHEATING CAN DAMAGE YOUR GRILL.

STAINLESS STEEL CARE:

Stainless Steel is widely used for catering and residential kitchen equipment because of its strength, its ability to resist corrosion and its ease of cleaning. In fact, stainless steel ranks alongside glass and new china in terms of “ease of cleaning” and in percentage removal of bacteria during washing. As a result of these virtues, the metal is often taken for granted and it is assumed that no problems will arise during its usage. However, some care is required to ensure that the stainless steel can live up to this reputation.

DAY TO DAY CARE:

To maintain the original appearance of your *Alfresco*™ Gourmet Grill, a regular cleaning routine should be carried out using the following guidelines:

1. After use, following the safety precautions detailed on page 4 and 5, wipe the Grill with a soft damp soapy cloth and rinse with clean water, preferably warm/hot water. This should remove most substances encountered during the grilling process.
2. For more tenacious deposits, including oil, grease and water-borne deposits, use a multi purpose cream cleanser and apply with a soft damp cloth. Rinsing with fresh water, as described above, should follow as a last step.
3. For really stubborn dirt or burnt-on grease, a nylon-scouring pad may be used in conjunction with the cream cleanser. On no account should “wire wool” pads be used unless they are made of stainless steel.
4. Harsh abrasives and scouring materials should not be used for cleaning stainless steel as they will leave scratch marks in the surface and damage the appearance of the Grill. Likewise do not use wire brushes, scrapers or contaminated scouring pads.
5. Your *Alfresco*™ Gourmet Grill has a directional polished grain, any cleaning with abrasives should be carried out along this grain direction and not across it.
6. After use, always remove wet cleaning aids (such as cloths, pads, containers) from the surface, to avoid formation of water marks or stains.
7. If required, dry the Grill after use with a soft dry cloth or towel.

If the preceding guidelines are adhered to, your *Alfresco*™ Gourmet Grill should offer excellent life and should live up to its reputation of being “stainless”.

Neglect of this practice, however, can lead to deterioration of the surface and, in some extreme cases, corrosion of the steel itself. The two most common types of corrosion that may be encountered, particularly on stainless steel, are rust marks and pitting of the surface.

RUST-BROWN MARKS:

When this type of staining occurs it is unlikely that rusting of the stainless steel itself caused the marks. Similar marks can be found with both porcelain and plastic sinks. The rust marks are more likely to be the result of small particles of “ordinary-steel” which have become attached to the surface; these have subsequently rusted in the damp environment. The most common source of such particles is from “wire-wool” scouring pads, but contamination may also occur from carbon steel utensils and old cast iron water supply pipes.

These brown marks are only superficial stains, which will not harm the Grill; they should be removable using a soft damp cloth and a multi-purpose cream cleanser.

Occasionally, it may be necessary to resort to a proprietary stainless steel cleanser, to return the surface of the Grill to its original condition. To avoid re-occurrence of any “rust-staining” it is essential that the source of the contamination is eliminated.

PITTING:

Another form of corrosion, which occasionally occurs in stainless steel, is pitting of the surface. The reason for this corrosive attack can usually be attributed to certain household products, for example:

Bleaches:

Most common domestic bleaches & sterilizing solutions contain chlorine in the form of sodium hypochlorite. If used in concentrated form, bleaches can attack the stainless steel, causing pitting of the

surface. They should always be used to the strengths prescribed by the manufacturer and should be thoroughly rinsed off with clean water immediately after use. All cleaning agents containing hypochlorite are unsuitable for long term contact with stainless steel and, even when used in the highly diluted form, they can produce pitting under certain conditions.

Foodstuffs:

In general stainless steel is fully resistant to all foodstuffs in common use. Only in isolated cases, such as when concentrated salt and vinegar mixtures are allowed to remain in contact with the steel for a long period, can any surface marking result.

CARE & MAINTENANCE OF YOUR GRILL:

GRILL RACK:

The easiest way to clean the round wire grill racks is immediately after cooking is completed and after turning off the flame. Wear a barbecue mitt to protect your hand from the heat and steam. Dip a brass bristle barbecue brush in hot soapy water and scrub the hot grill rack. Dip the brush frequently in the bowl of water. Steam, created as water contacts the hot grill, assists the cleaning process by softening any food particles. The food particles will fall and burn.

If the grill is allowed to cool before cleaning, then cleaning will be more difficult.

The V-grate used for the IR burner will primarily self-clean during the 5 minute IR burner cleaning period (Rear IR-Burner cleaning below). After the grate has cooled, remove it from the grill and brush off burned debris.

STAINLESS STEEL:

The Grill is made from commercial quality type 304 non-rusting and non-magnetic stainless steel, and the cleaning information shown on Page 29 should be followed.

DRIP TRAY:

The drip tray should be cleaned after every usage of the grill. After allowing the grill to cool completely, remove the drip tray by pulling it out from the grill until it stops, then lifting the front edge about 45° to remove from grill.

Reinstall by placing rear of tray into guides, then lifting front edge 45° to re-insert the tray. Slide completely into the grill.

GRILL BURNERS:

Before removing the burners, make sure that the gas supply is OFF and the control knobs are in the OFF position. Allow grill to cool completely, then lift off the grill racks and briquette trays. To remove burners, lift the rear of the burner out of the bracket.

Angle the burner slightly to clear the igniter electrode and opening at the front of the grill. Slide burner straight off the orifice tip. Great care should be used when installing a burner, as it must be correctly centered and secured on the orifice before any attempt is made to relight the grill. The burner should lie flat and not have any side-to-side movement. Frequency of cleaning will depend upon grill use.

NOTICE

NEVER CLEAN THE V-GRATE WITH ANY TYPE OF LIQUID WHILE IT IS ON THE GRILL. LIQUID CAN PERMANENTLY DAMAGE THE IR-BURNER.

WARNING

DO NOT ALLOW EXCESS GREASE OR LIQUIDS TO ACCUMULATE IN THE DRIP TRAY AS THIS WILL CREATE A FIRE HAZARD.

AVERTISSEMENT

NE PERMETZ PAS D'EXCESSER UNE GRAISSE OU DES LIQUIDES À ACCUMULER DANS LE BANDE DE DÉCHARGE, CELUI-CI CRÉER UN RISQUE D'INCENDIE.

WARNING

DO NOT ATTEMPT TO REMOVE THE DRIP TRAY DURING USE OR WHILE IT IS HOT AFTER USING THE GRILL.

AVERTISSEMENT

NE TENTUREZ PAS DE RETIRER LE BANDE DE DÉCHARGE PENDANT L'UTILISATION OU QU'IL SOIT CHAUD APRÈS UTILISATION DU GRILL.

U-BURNER CLEANING:

Clean the exterior of the burner with a brass wire brush. Clear any stubborn scale with a metal scraper. Clear any clogged ports with a thin wire. Never use a wooden toothpick as it may break off and clog the port. Shake out any debris through the air shutter. Use a flashlight to inspect the burner inlet to ensure it is not blocked, if obstructions can be seen, use a stiff wire to clean out the burner throat.

IR-BURNER CLEANING:

AFTER EACH USE, IT IS NECESSARY TO BURN ALL IR BURNERS WITH THE HOOD OPEN FOR AT LEAST FIVE MINUTES TO VAPORIZE ANY FOOD DRIPPINGS OR PARTICLES. It may occasionally be necessary to brush, blow or vacuum accumulated ash from the burner surface. Do so carefully and only when the burner is cool.

 **NOTICE**
**FAILURE TO PERFORM THIS STEP
WILL DAMAGE THE IR-BURNER**

ORIFICE CLEANING:

With the burner removed, remove the orifice and shine a flashlight through the openings to ensure there is no blockage. Use a needle to clear any debris. Be extremely careful not to enlarge the hole or break off the needle.

TO REASSEMBLE THE BURNERS:

Replace the burner by sliding the air shutter over the brass orifice, centering it in the hole and resting the rear of the burner onto its supporting bracket.

IT IS EXTREMELY IMPORTANT TO CENTER THE BURNER ON THE ORIFICE PROPERLY.

Be careful not to upset the air shutters' original position (unless readjusting). Make sure the burner is level and does not rock. Special care must be taken not to hit or damage the electrode wire while replacing the burners.

ELECTRODE GAPS:

The right gap must be maintained to ensure a proper spark. The gap should be 1/8" to 3/16". To adjust gap, hold the base of the wire rod tightly with a pair of pliers, and with another set of pliers, twist the tip of the wire to achieve the correct gap

NOTE: Rough handling of the electrode can crack the ceramic body, causing all of the igniters to fail. Replace the briquette trays, ensuring that they sit level and do not rock. Light all of the burners and check for proper flame characteristics (see page 15).

CLEANING THE BRIQUETTES AND TRAYS: After allowing the grill to cool completely, turn the briquette assemblies (briquettes and tray) upside-down and operate the grill on high for 30 minutes. After allowing to cool again, return the briquette assemblies to their proper (flat side down) position. The trays can occasionally be scrubbed clean when needed after allowing them to cool completely. Never handle hot trays.

ADDITIONAL CONSIDERATIONS:

Always keep the area around the grill free of obstructions and debris. Maintain at least 3" of space around grill to ensure proper airflow, and keep all ventilation openings clear and free of debris. Visually check flame characteristics and compare to description on page 15. Adjust if needed. Clean appliance after each use, and check for blockages, especially at the burner orifices, after periods of prolonged non-use. To maintain the appearance of your *Alfresco*[™] Gourmet Grill for many years, keep it covered when not in use. Backyard environments are harsh on your grills' finish. Long exposure to sun, water, yard chemicals and the elements will reduce the appearance of the stainless steel. This is especially applicable in ocean front locations, or locations subject to sea mists.

Alfresco[™] Gourmet Grills strongly recommends that you cover your Grill when not in use.

TROUBLESHOOTING:

BEFORE CALLING FOR SERVICE:

If your ALFRESCO™ Gourmet Grill does not function properly use the following checklist before contacting your dealer for service. You may save the cost of a service call and the inconvenience of being without your grill. Additional troubleshooting tips can be found on our website at www.alfrescogrills.com.

SPIDER AND INSECT WARNING:

Spiders and insects can nest in the burners of this or any other grill, and cause the gas to flow from the front of the burner. This is a very dangerous condition, which can cause a fire to occur behind the valve panel, thereby damaging the grill and making it unsafe to operate.

WHEN TO LOOK FOR SPIDERS: You should inspect the burners at least twice a year or immediately if any of the following conditions occur:

1. The smell of gas in conjunction with the burner flames appearing yellow.
2. The Grill does not reach temperature.
3. The Grill heats unevenly.
4. The burners make popping noises.

GRILL WON'T LIGHT:

First determine if the spark igniters are functioning properly. A rapid snapping sound should be heard when the igniter button is depressed. If no sound is heard, check power supply. Is the power cord connected? Has GFCI tripped? If power supply is okay, then ensure that the proper gap exists between the burner and electrode wire, according to the procedure on page 24.

If the spark igniters are working correctly, next determine if gas is reaching the burners. Ensure the gas supply is turned on, and that there are no leaks according to the procedure on page 11. Attempt to match-light a burner.

If the burner will light with a match, then the spark igniter may not be functioning correctly, or may not be adjusted correctly. Adjust according to the procedure on page 24 or call for service. If the burner will not match light, and the gas supply has been confirmed, then check the burner for blockages according to the procedure on page 24.

FLAME IS YELLOW / GAS SMELL:

IF YOU SMELL GAS WHILE THE GRILL IS OPERATING, IMMEDIATELY TURN OFF ALL BURNERS. Perform a leak test and check for blockages according to the procedure on page 24. Also check the air shutter adjustment according to the procedure on page 15.

NOTE: If the grill is operating in a dusty area or if heavy grease is present, some orange tips on the burner flame should be considered normal.

LOW / INSUFFICIENT HEAT:

Ensure that adequate preheat time has elapsed. U-burners should preheat for at least 15 minutes with the hood closed (20 ~ 25 minutes for high heat); IR burners should be allowed to preheat for at least five minutes with the hood open.

If adequate preheat time was allowed, check the gas supply for a damaged and/or kinked supply line. Replace if necessary. On LP units, a mostly empty tank may not have sufficient pressure to run the grill at high heat. Replace with a full tank. Make sure that the regulator/hose assembly being used is the unit supplied with the grill. On NG units, ensure that the flexible supply line is at least 1/2" diameter.

Check the gas supply pressure to ensure at least 7" W.C. for NG and 11" W.C. for LP.

If gas supply is adequate, check burners for blockages according to the procedure described above. Check flame characteristics according to the procedure on page 15 and adjust air shutter if needed.

Check that there is no pressure being applied to the regulator attached to the back of the grill. This regulator contains a flexible diaphragm and should not touch the grill body or any surrounding objects.

Check to make sure that the burners and the drip tray are clean and free from obstructions.

Clean if necessary.

NOTE: No part of the grill should ever be lined with aluminum foil as it will interfere with airflow and can cause a low heat condition in the firebox and a high heat condition inside the control panel.

BURNER BLOWS OUT:

First determine if the problem is being caused by location. If location is subject to high winds, reposition grill to provide some protection by placing the back of the grill toward the wind. Check the gas supply and flame characteristic according to the procedure under Low / Insufficient Heat. Check to ensure that burners are correctly positioned in the grill according to the procedure on page 5. Correctly installed burners should be seated firmly with no side-to-side movement.

ROTISSERIE WON'T LIGHT:

Follow the same procedure as "grill won't light", on page 14, to diagnose problems with the Rotisserie IR burner. The IR burner flame may be hard to see in bright sunny conditions.

SMOKER BURNER WON'T LIGHT:

Follow the same procedure as "grill won't light", on page 14, to diagnose problems with the Smoker burner. Remove the wood chip tray to better see the smoker burner flame. When using the smoker with the main grill burners, the smoker burner should be lit first and allowed to preheat before lighting the grill burners.

GRILL GETS TOO HOT:

IF THE GRILL GETS TOO HOT, TURN IT OFF IMMEDIATELY AND ALLOW IT TO COOL. Perform a leak test according to the procedure on page 11. If leaks cannot be corrected, call for service before attempting to use the grill.

LIGHTS DON'T WORK:

Check that power is connected and that the GFCI has not tripped.

LIGHT BULB REPLACEMENT:

NOTE: Disconnect all power to your *Alfresco*™ Gourmet grill before any service or light bulb replacement is performed. There are two types of lights on your ALXE grill, incandescent in the cooking area (*Figure #9*) and LED panel lights under the control panel bullnose (*Figure #10*). The Bullnose lighting system requires replacing the entire LED array as an assembly.

Incandescent light bulbs are located on the left and right side of the rear hood above the cooking area. The area around the light fixtures and the light fixtures themselves become extremely hot during grill operation with or without the lights being turned on.

BEFORE REPLACING ANY INCANDESCENT LIGHT BULBS, ALLOW SUFFICIENT TIME FOR THE FIXTURES TO COOL DOWN IF THE LIGHTS OR THE GRILL WAS TURNED ON, OR BOTH.

Incandescent Light bulbs can reach several hundred degrees when operating, so allow plenty of time for them to cool down.



Figure # 9

G940120-G9 BASE
40W-120 VAC
Part# 210-0317



Figure # 10

LED ASSEMBLY	
BBQ MODEL:	PART NUMBER:
ALXE-30	510-0998
ALXE-36	510-0962
ALXE-42	510-1000
ALXE-56	510-1001
ALXE-56 BFG	510-1002

INCANDESCENT LIGHT BULB REPLACEMENT:

Should you need to replace the light bulbs in your *Alfresco*™ Gourmet Grill, please refer to the following steps :

REMOVE THE LIGHT COVER

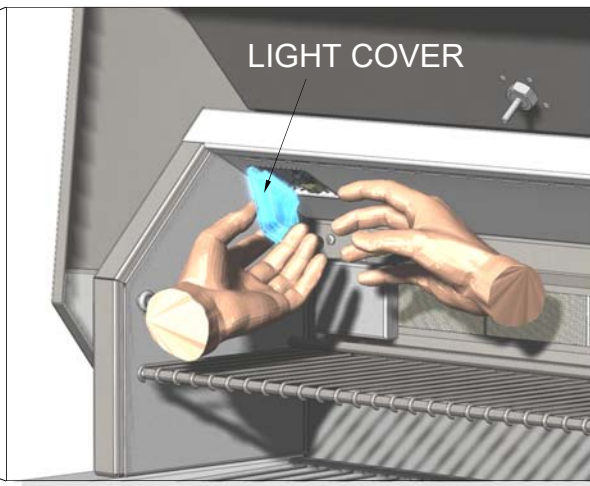
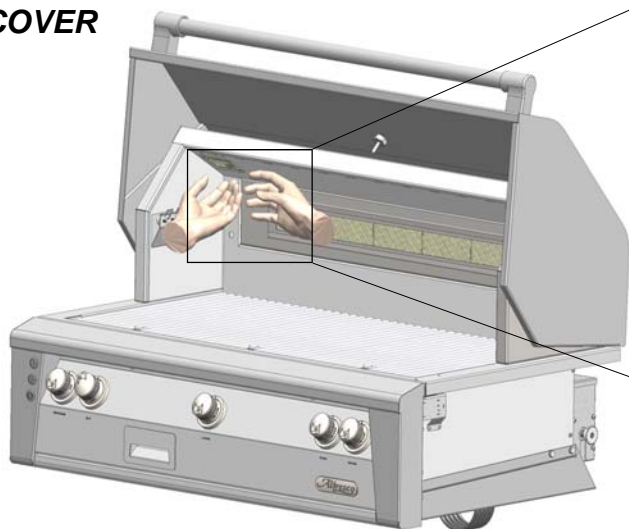

The light covers are supported by a spring mechanism on the light fixture. Simply pry open the light cover from the left or right sides by hand only.

DO NOT USE ANY TOOLS as you might chip the tempered glass cover.

REMOVE THE LIGHT BULB

Reach inside the light fixture and remove the light bulb by pulling it straight out of the socket.

INSTALLING A NEW LIGHT BULB:

NOTE: When replacing light bulbs, use a soft clean cloth (cotton or paper towels) when handling lights.

Always keep halogen lights free of fingerprints and grease when replacing. Because of the light bulb's very high operating temperature, grease or fingerprints left on the light bulb might reduce the bulb's life.

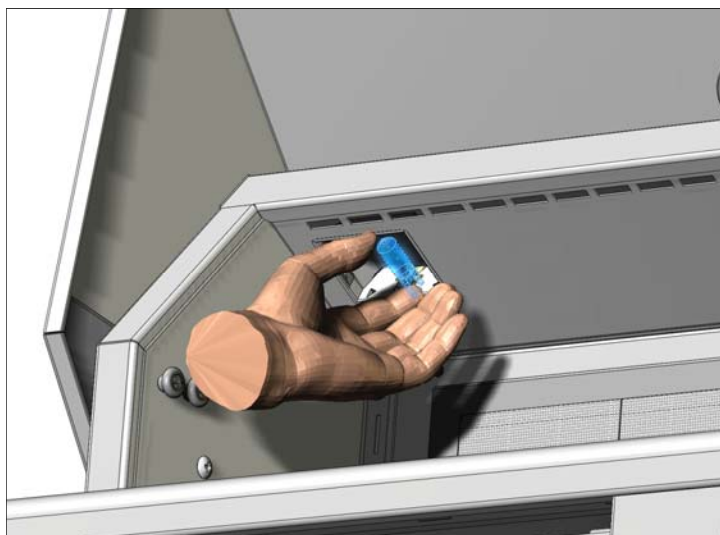

Insert a new light bulb using a clean cloth and do not force the light bulb in the socket. Very little effort is required for the bulb to "SNAP" and lock into place.

Look at the bulb and verify that no fingerprints are left on it. Wipe off any fingerprints and or grease that might have accidentally come in contact with the glass of the light bulb.

Replace the light cover by inserting it into the light fixture at a slight angle until it "SNAPS" into place.

Power up your *Alfresco*™ Gourmet Grill and verify the light bulb operation by turning on the light

FRONT PANEL LED LIGHTING REPLACEMENT:

To replace an LED light, simply detach the light assembly rail located at the under the bullnose of the front control panel of your *Alfresco*™ Gourmet Grill.

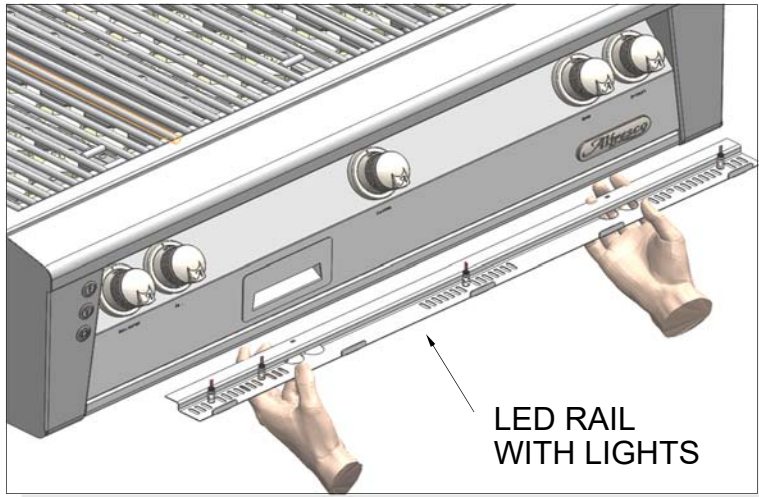
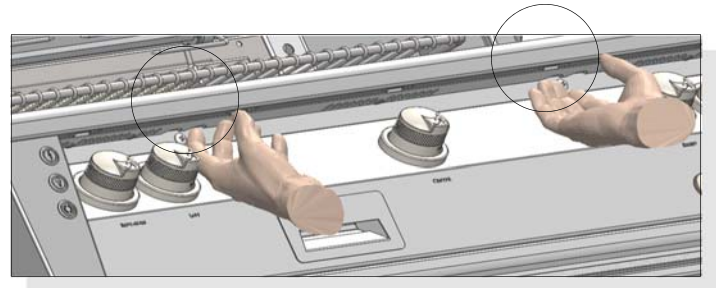
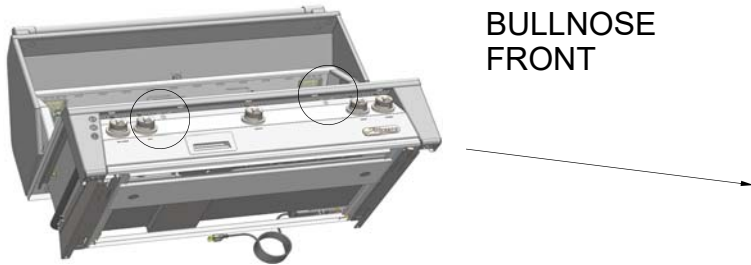

STEPS:

1. Pull Out (SNAP OUT) and Down.
2. Drop of the panel carefully ensuring the LED panel comes down with the electrical plug connector on the left side.
3. Disconnect the plug and completely remove the light assembly

- To re-install, repeat these steps in the reversed order .

TIP: Very little effort is required to SNAP OUT and re-install the LED assembly into place.

To ease the effort, all knobs may be temporarily removed. Test by powering up our *Alfresco*™ Gourmet Grill and turning ON the light switch.

APPENDIX:

CART MOUNTED UNITS — CART SECUREMENT:

To prevent your *Alfresco* Cart and Barbeque from rolling on a leveled or uneven floor, secure the cart's caster wheels located on the front of the cart.

The caster wheels are accessible by opening the doors and using the wheel's side lever to **LOCK** or **UNLOCK** the backing system of the wheels as shown to the right.

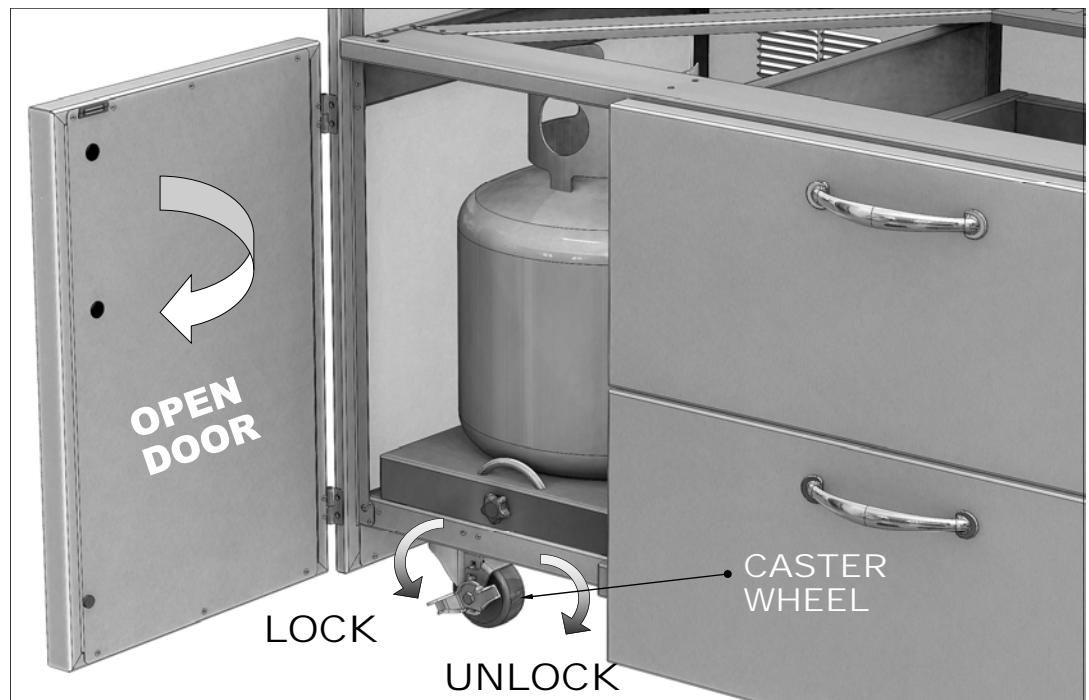

ADDITIONAL IMPORTANT CLEANING AND STORAGE CONSIDERATIONS:

In order to maintain your grill in clean working order, it will be necessary, under certain conditions, to take additional precautions:

- If your grill is located in a coastal area, it will be exposed to salty air which is corrosive.
- If it is located close to a swimming pool or Jacuzzi with chlorinated water, then it will be exposed to dilute hydrochloric acid which can be formed as a result of chlorine compounds used in the pool causing chlorine to be combined with hydrogen and water in the atmosphere.
- Muriatic acid (another name for hydrochloric acid) is used to maintain the correct pH balance in the pool water. Chlorine is an oxidizing agent, and as such can promote rapid corrosion or other oxidizing processes which can damage various materials.

Type 304 stainless steel is highly resistant to corrosion but given enough exposure to such corrosive conditions might succumb to some degree, such that pitting or rusting may occur.

Our barbecue materials have been tested in saline solutions with higher salinity than sea water, and they have been tested in highly chlorinated solutions. They have also been tested by exposure to highly acidic foods. During and after these tests, we found these materials were able to withstand exposure over prolonged periods of time. However, the above mentioned corrosive substances, along with neglect, can lead to a situation whereby conditions might combine to cause some damage to occur.

Therefore, we suggest that you always keep your barbecue clean, dry and covered when not in use. This is even more important when long term storage is intended; always store the grill clean, dry and covered with your *Alfresco* Barbecue Cover.

Do not allow any food particles or grease to be left inside your barbecue, as this will attract rodents which, in addition to being undesirable from an hygienic standpoint, are likely to cause physical damage to your barbecue. Rodents are known to chew on the insulation of wiring which will eventually cause permanent damage to the wiring and possibly electrical components.

One final consideration for barbecues located either along the coast or in a desert community: Wind driven sand is highly abrasive, therefore constant exposure will eventually pit and scratch almost anything; one more reason to keep your barbecue covered when not in use.

By routinely caring for your barbecue as outlined in this manual, you can enjoy many years of service from it and keep it looking the way it should.

In the event that any light rusting is found on the stainless steel, it will usually not be the stainless steel which is corroding but iron particles which have somehow been deposited on the surface. For more information on this subject, please request our "Rust removal bulletin".

As a first course of action though, we recommend "Bar Keepers Friend", available from many supermarkets and hardware stores. This product, if used as directed, will usually solve the problem. Note though, when using this product on textured surfaces such as your barbecue, always rub in the direction of the grain; never across the grain, since doing so will damage the finish.

Refer also to pages 22 ~ 23 for additional Stainless Steel Care tips.

AlfrescoTM # # Gourmet Grills Limited Warranty

GRILLS (Residential use only)

LIMITED LIFETIME WARRANTY

Alfresco will repair or replace any stainless steel part including all fabricated stainless steel components, stainless steel burners and standard round grill grates (excluding what is covered in the Five Year Limited Warranty) to be defective from workmanship and when subjected to normal residential use and service. This warranty excludes surface corrosion, scratches, discoloration, weather and atmospheric related staining, and minor surface rust and oxidation which are normal conditions. Labor to remove and replace defective parts is not covered after first year of ownership. Shipping and handling cost will apply. Alfresco recommends that you use an authorized Alfresco servicer to perform such service.

LIMITED FIVE-YEAR WARRANTY

Alfresco warrants the stainless steel briquette trays, gas valves and drip pans, to be free from defects in materials and workmanship under normal residential use for a period of five years from the original date of purchase. Labor to remove and replace defective parts is not covered after first year of ownership. Shipping and handling cost will apply. All service provided by Alfresco under this warranty must be performed by an authorized Alfresco servicer.

FULL TWO YEAR WARRANTY

For two years from the date of original purchase, your Alfresco grill warranty covers all parts and labor to repair or replace, under normal residential use, any part of the product that proves to be defective in materials or workmanship. All service provided by Alfresco under this warranty must be performed by an authorized Alfresco servicer, unless otherwise specified by Alfresco. Service will only be provided during normal business hours.

TERMS APPLICABLE TO EACH WARRANTY

The warranty applies only to products installed for normal residential use. The warranty applies only to products installed in any one of the fifty states of the United States, the District of Columbia or the ten provinces of Canada. This warranty does not cover any parts or labor to correct any defect caused by negligence, accident or improper use, maintenance, installation, service or repair.

SERVICE & REPLACEMENT PARTS

For quicker and easier results visit our website at: <http://www.alfrescogrills.com> or, call 866-203-5607 to report service problems and/or to obtain replacement parts for your Alfresco Grill. Replacement parts are shipped F.O.B. City of Industry, California 91745. Before calling for service, please make sure you have the following information: **Model number, serial number, date of purchase, and proof of purchase** by original owner.

Limitations & Exclusions: 1. Alfresco's warranty applies only to the original purchaser and may not be transferred. 2. Alfresco's warranty is in lieu of all other warranties, expressed or implied and all other obligations or liabilities related to the sale or use of its grill products. 3. Alfresco's warranty shall not apply and Alfresco is not responsible for damage resulting from misuse, abuse, alteration of or tampering with the appliance, accident, hostile environment, flare-up fires, improper installation, or installation not in accordance with the instructions contained in the User Manual, or the local codes. 4. Alfresco shall not be liable for incidental, consequential, special or contingent damages resulting from its breach of this written warranty or any implied warranty. 5. Some states do not allow limitations on how long an implied warranty lasts, or the exclusions of or limitations on consequential damages. This warranty gives you specific legal rights and you may have other rights, which vary from state to state. 6. No one has the authority to add to or vary Alfresco's warranty, or to create for Alfresco any other obligation or liability in connection with the sale or use of its products.

Alfresco shall not be responsible for and shall not pay for the following: 1. Installation or start-up. 2. Service by an unauthorized service provider. 3. Damage or repair due to service by an unauthorized service provider or use of unauthorized parts. 4. Improper installation. 5. Damage caused by accidents, abuse, alteration, misuse, installation that is not in accordance with the instructions contained in the User Manual, or local codes. 6. Units installed in non-residential applications such as retirement homes, restaurants, hotels, schools, etc. 7. To correct normal adjustments or settings due to improper installation, commissioning or local gas supply properties. 8. Shipping and handling costs, export duties, or installation cost. 9. The cost of service calls to diagnose trouble; or removal or re-installation cost.

Alfresco™

Open Air Culinary Systems