

INSTALLING VANITY WITH TWO PEOPLE IS HIGHLY RECOMMENDED
L'INSTALLATION DE LA VANITÉ AVEC DEUX PERSONNES EST FORTEMENT RECOMMANDÉE

Box Contents/Contenu de la boîte

- Ceramic Basin/Countertop
Bassin/comptoir en céramique
- Vanity Base/Cabinet
Base de vanité/Cabinet
- Vanity Mirror/Aluminum Frame Mirror
Miroir de courtoisie/Miroir à cadre en aluminium

Main Body Parts/La partie principale du corps

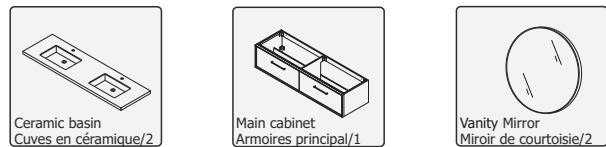

Installation Tips/Conseils d'installation

- Add silicone to attach frame/
Ajouter du silicone pour fixer le cadre
- Secure the countertop to the main cabinet/
Fixez le comptoir à l'armoire principale

Main Cabinet Installation Instructions/Instructions d'installation de l'armoire principale

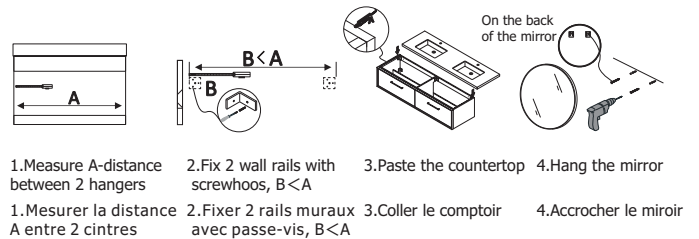

Installation too/Outil d'installation

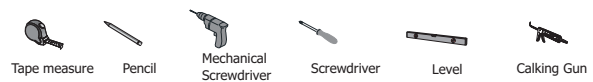

Recommended tools/Outils recommandés

- Tape measure/
mètre à ruban
- Pencil/
Crayon
- Screwdriver (Manual/Mechanical)/
Tournevis (manuel/mécanique)
- Level/Niveau
- Calking & Calking Gun/
Pistolet à calfeutrer et à calfeutrer

Installation Instruction/Instructions d'installation

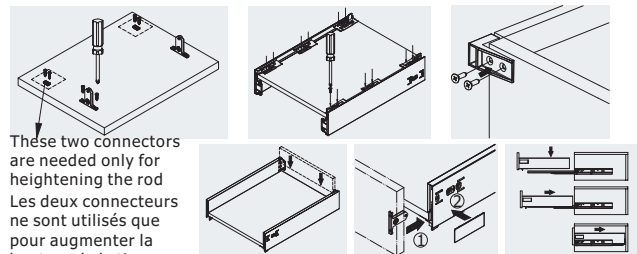

The drawer is adjusted
Le tiroir est réglé

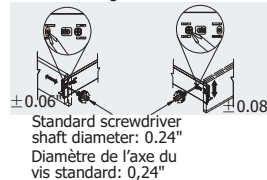

Heightening rod installation, adjustment and removal
Installation, réglage et retrait de la tige de surélévation

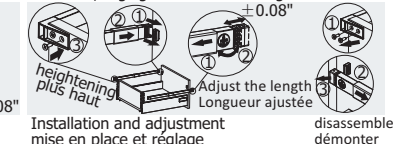

• Please check your product packaging to make sure the included accessories etc.

Diagram Specifications

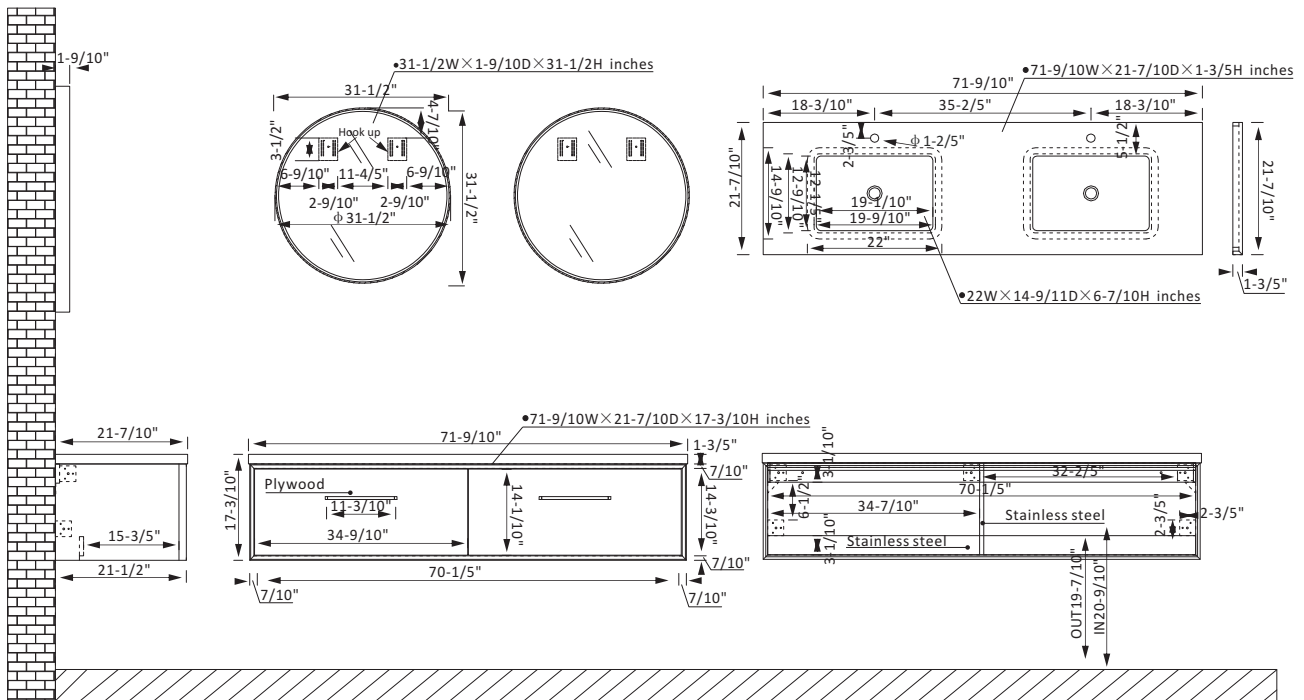

Vanity Care Guide

Vanity Care

- Avoid direct contact of sharp objects as they can cause exterior damage.
- Do not expose directly to the sun as it can cause aging and cosmetic damage.
- Avoid placing hot objects onto the vanity surface.

Countertop Care

- Kindly note that all our tops are sealed before shipping but may stain, scratch, or chip because they are porous by nature.
- Do not place hot items directly on the countertop as it can damage it.
- To prevent ring marks or staining, dry immediately.
- Place table mats beneath objects that can potentially scratch the surface.
- Use a clean, soft fabric to dust the vanity.
- Occasionally wash with a cloth dampened in warm water. If needed, apply a small amount of mild dishwashing liquid or stone soap to clean. Dry with a soft cloth.
- Refrain from using chemical cleaners, sprays, abrasive cleaners, or products that contain lemon, vinegar, or other acids.
- We advise to reseal top annually or when necessary.

Cleaning and maintenance

- Avoid using cleaning products that contain Bleach or Ammonia.
- Please use wood-friendly products on wooden base vanities.
- To adequately clean exterior surfaces, use natural cleaning solutions or soap

WARNING

This product can expose you to chemicals including Nickel compounds, which is known to the State of California to cause cancer. For more information visit [www. P65Warning. ca. gov](http://www.P65Warning.ca.gov)

WARNING

This product can expose you to Glass wool fibers (inhalable and biopersistent), which is known to the State Of California to cause cancer. For more information, go to www. P65Warnings. ca. gov

WARNING

Serious or fatal crushing can occur from furniture tip over . To prevent tip over this furniture must be used with the wall attachment device(s) provided.

Screw(s) and plug(s) for the wall are not included. Use screw(s) and plug(s) suitable for your walls. If you are uncertain, seek professional Advice. Read and follow each step of the instruction carefully.