



sensory play



imaginative play



for ages 3+

Poles



A 2 pcs



B 6 pcs



C 2 pcs



D 2 pcs



E 2 pcs



F 2 pcs



G 2 pcs



H 2 pcs



I 2 pcs



J 1 pcs

Joins

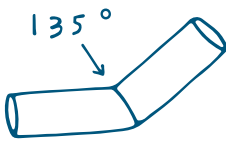

K 2 pc

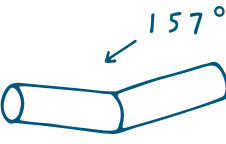

L 2 pc

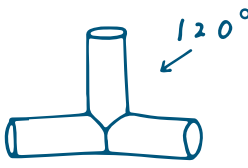

M 4 pc

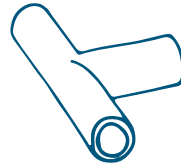

N 8 pc

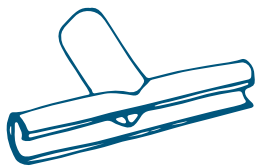

O 2pc

House Cloth

1 pcs

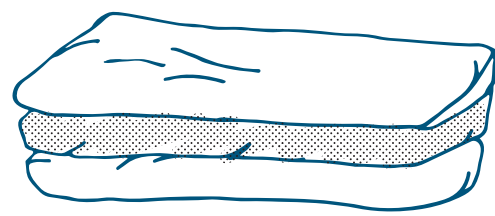



Step 1

Assemble the base pieces of the camperva using the join pieces.

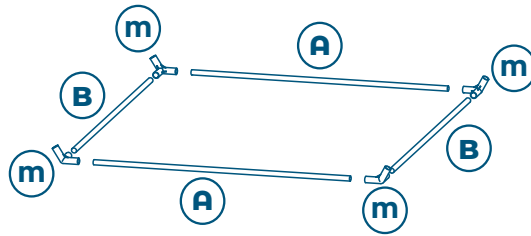

Step 2

Add the first upright poles to the base using the join pieces.

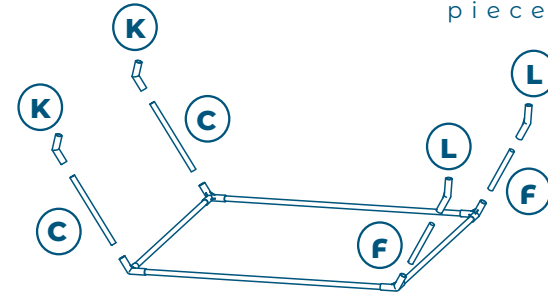

Step 3

Add the next set of poles to the joins.

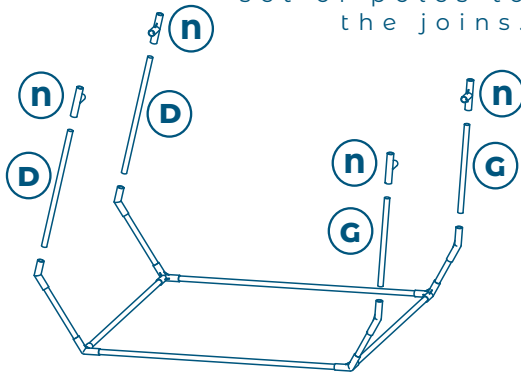

Step 4

Use crossbars to connect both sides of the campervan.

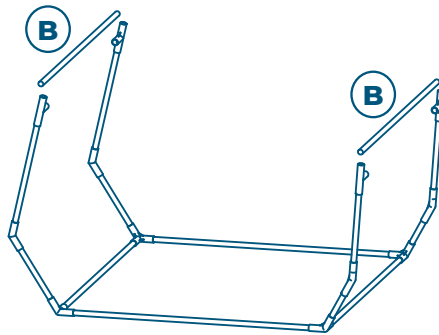

Step 5

Add curved pieces on top corners.

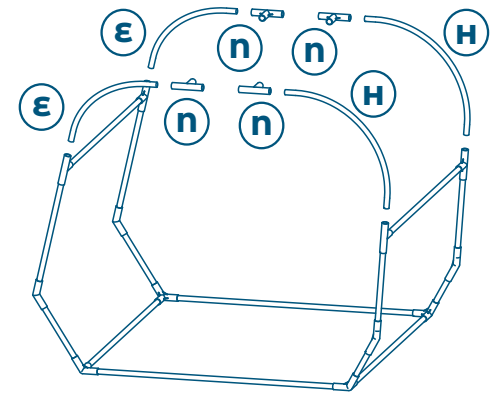



Step 6

Use crossbars to join frame through centre.

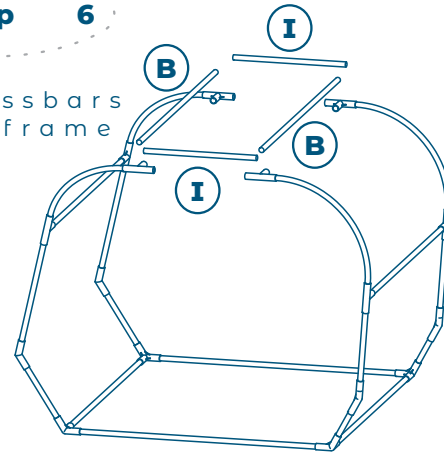

Step 7

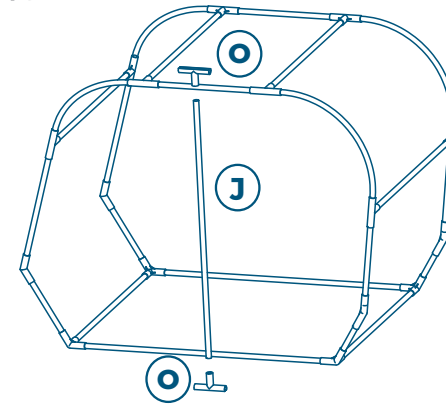

Step 8

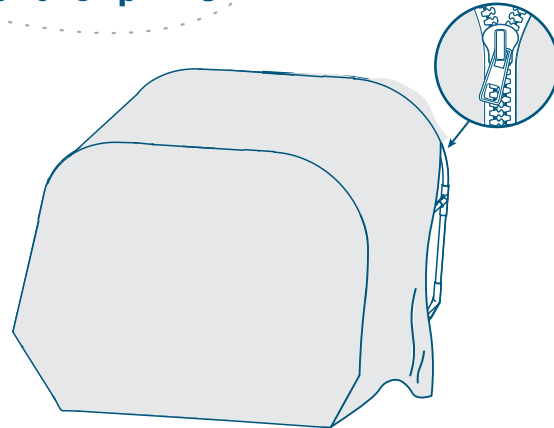

Step 9

