



PRODUCT MANUAL



Thank you for your purchase.

Visit www.shopjourney.com for many more ways to live life to the fullest.



- 1. Instructions.....3
- 2. Precautions for Safe Use.....4-11
- 3. Structure and Performance.....12-13
- 4. Specifications.....14
- 5. Installation, Folding and Troubleshooting.....15-16
- 6. Use and Operation.....17-21
- 7. Glitch Diagnosis.....21
- 8. Safety Devices and Accident Treatment.....22
- 9. Maintenance.....22-24
- 10. Storage.....25
- 11. Opening and Checking25
- 12. Warranty.....26

1. Instructions

Read and follow all instructions, warnings and notes in this manual before attempting to operate your Journey Air for the first time.

If there is any information in this manual that you do not understand, or if you require additional assistance for assembly or operation, please contact your authorized local provider. The symbols just below in the box are used in this manual to indicate warnings or information important to your safety. Please be sure you fully understand all warnings and cautions. It is strongly recommended that you should read and understand them completely.



WARNING! Failure to heed the warnings in the manual may result in personal injury.



ATTENTION! Failure to heed the cautions in the manual may result in damage to the Journey Air

1.1 This Journey Air integrates advanced technology with modern style. The structural design is especially convenient in that it allows for quick and easy disassembly and reassembly—so important for transporting the chair in the trunk of your vehicle when traveling, as well as for storage when not in use. The design features, excellent performance and trouble-free operation of your personal electric vehicle will add convenience, comfort and confidence to your daily life.

1.2 This personal electric vehicle is suitable for the elderly, the infirm who have difficulty walking, and for anyone who wants an easier way to get from place to place. The maximum user weight is 240 lbs (108.8 kg). 1.3 This personal electric vehicle is suitable for a broad range of indoor operations, as well as for use along level streets or paved areas near buildings, but is not designed for use on grass or graveled areas; on slopes, hills or inclines; or for roads with motorized traffic. It is unsuitable for any outdoor use on rainy or snowy days.

2. Precautions for Safe Use



WARNING! To ensure your safety, please read and understand this manual. You must be on high alert to ensure safety when driving any mobility unit.



WARNING! Please read the following warning carefully to avoid damage or personal injury caused by improper operation. Journey Air users should take appropriate safety measures and obey local pedestrian traffic rules. The company is not responsible for personal injury and/or product damage caused by improper operation. When you sit in the personal electric vehicle, it may be difficult for others to see you. Use of safety equipment such as reflectors, reflective clothing, lights and safety signs is critical to your safety.



WARNING! Please consult your health care professional regularly to ensure that there are no health or physical conditions that limit or compromise your safe operation of the personal electric vehicle. If you are taking prescription or over-the-counter medications, or if physical activity is limited, please consult your physician. Some medications and medical conditions may impair your ability to operate the personal electric conditions.



WARNING! Do not operate your personal electric vehicle while drunk. Drinking may affect your safe operation of the personal electric vehicle.
WARNING! All personal electric vehicles are not the same. Please take the time to learn the specifics of operating this one before driving it.
WARNING! Always remember that operating a personal electric vehicle safely, skillfully and confidently takes time and practice.



WARNING! Please do not use the personal electric vehicle for purposes other than mobility transportation. It is not designed for activities such as weight training, sports and athletics, traction, or moving or dragging objects—any of which could cause the chair excess stress and constitute a safety hazard.
WARNING! This personal electric vehicle is for one person only. The maximum weight load is 240 lbs (108.8 kg) with no passengers allowed. To avoid overloading and possible rollover, do not attempt to carry any additional weight.



WARNING! We strongly recommend that you do not smoke in the personal electric vehicle. If you decide to smoke in the chair, be careful with ashes, keeping them away from the personal electric vehicle seat. Be sure your cigarette is completely extinguished before discarding it.



WARNING! When getting in the personal electric vehicle, sit back as far as possible on the seat. When getting out, sit back and avoid putting too much weight at the front of the chair. Unbalanced weight distribution can cause an overturn and result in injury.

WARNING: The armrests are not transfer bars. Do not use them to push or lift yourself from the chair as such use may cause injury to you and damage to the chair.

WARNING: DO NOT concentrate all your weight on the footrest as the chair may overturn, causing personal injury.



WARNING: Do not use the personal electric vehicle in manual mode without an accompanying person to push it along. Trying to propel yourself while sitting could cause personal injury.

WARNING! Do not make any alterations to the personal electric vehicle without permission. Adding accessories may change some of the personal electric vehicle specifications such as total weight, size or center of gravity. Please be aware that unauthorized alterations or accessories may damage the chair and/or negatively affect your personal safety.



WARNING: Be extremely careful when using oxygen near electrical circuits or combustible materials. Please contact your oxygen supplier for information on the safe use of oxygen.



ATTENTION! Do not change the controller settings. Please ask your service provider to check the controller settings every 6-12 months. If you notice any changes in your ability to control the personal electric vehicle, please contact your service provider.



WARNING! It is possible that the personal electric vehicle could stop suddenly at any time during operation. If you sense or see anything unusual or irregular in its performance, immediately cease operation. If necessary, contact your service provider.



WARNING! Do not place the personal electric vehicle on an incline or slope when it is in manual mode as it could move forward/backward on its own.



WARNING! If you expect to sit in a fixed position for a long time, turn off the power to prevent accidental movement of the personal electric vehicle.



WARNING! Avoid any accessory that might interfere with the operation of the joystick, as accidental contact could cause the personal electric vehicle to move unexpectedly.



WARNING! Keep yourself, clothing and other objects away from the wheel while the personal electric vehicle is moving. Do not pull anything behind the personal electric vehicle while driving. Loose clothing and other items can get sucked into tires and/or turning gears.



ATTENTION! Do not connect any other devices to the electronic system or turn on any other devices with the personal electric vehicle battery.
ATTENTION! When disconnecting the wiring harness, hold the terminal to prevent damaging it. Do not pull the wiring harness directly out.



WARNING! Keep all charger connector terminals clean and dry, away from damp sources to prevent damage to electrical system and/or personal injury.



ATTENTION! The storage temperature of the personal electric vehicle is -59°F~104°F. Long-term storage in lower or higher temperatures will damage the chair's functioning.



ATTENTION! Always check electrical components for corrosion. Check all brakes for any looseness, wear or damage. Check wiring harnesses and terminal posts for breakage. If necessary, please contact your service provider.



ATTENTION! Please ensure the safety of personal electrical vehicles and batteries during transportation. Never transport personal electrical vehicles or batteries with combustible materials.



ATTENTION! Please use the battery under the supervision of service technicians authorized by the company. Battery connectors, terminals and related accessories contain lithium, lead and lead components.



ATTENTION! Do not connect the cable directly to the battery terminal/clip for charging.
ATTENTION! Do not remove the fuse from the battery harness. If the fuse is damaged, please contact your supplier for replacement.



WARNING! Do not operate the personal electric vehicle with a dead or dying battery. Do not let the battery get so low that you might get stranded.
WARNING: Please slow down when turning and avoid making sharp turns. To prevent rollover, keep the center of gravity stable when making turns.



WARNING! When climbing a hill or elevation, drive straight on up. Both front wheels should reach the top at the same time. Never go up an incline at an angle as that approach could result in overturning. Always be particularly careful when climbing slopes.



WARNING! Do not drive on potentially dangerous roads or slopes, including but not limited to roads covered with snow, ice, cut grass or wet leaves.



WARNING! Keep the personal electric vehicle moving when climbing. If you need to stop, restart slowly and speed up carefully.



WARNING! Please drive down a slope at the minimum speed. If the descent speed is faster than expected, release the joystick lever to stop the personal electric vehicle, and then press the lever lightly to control the descent speed.



WARNING! The recommended maximum climbing angle (see parameter table) was tested in a controlled environment. Your personal electric vehicle's ability to climb is affected by factors such as your weight, the speed of your personal electric vehicle and the angle at which you approach the slope.



WARNING! Reversing is possible only on flat roads. When reversing, please operate smoothly at low speed. Please stop frequently and check to make sure there are no obstacles on the road.



WARNING! When sitting in a personal electric vehicle, avoid any position or movement that can change your center of gravity. This may cause the personal electric vehicle to tilt.



WARNING! Do not put all your weight on one side of the personal electric vehicle deck as such an unbalance could cause the chair to tilt or tip over.
WARNING! Do not put your hands above the seat or tilt your body. This may damage the backrest and cause you to fall down.



WARNING! Even if your personal electric vehicle can cross high obstacles, we recommend that you do not try to cross a height exceeding 1 inch. Such an attempt may cause the personal electric vehicle to be unstable. Riding a personal electric vehicle over an obstacle of such height can cause a rollover and severe personal injury. If you have any concerns about safely crossing an obstacle, do not attempt to do so without asking for help. Please keep in mind the extent of your operating skills and any physical limitations. You may need to remove or cover sills and install ramps at exits and entrances.



WARNING! Do not attempt to climb over obstacles on slopes.
WARNING! Do not rely on one wheel to get you over an obstacle. The accompanying “tilt” may cause a tip over.



WARNING! Never operate the personal electric vehicle near railroad tracks or crossings.



WARNING! Do not drive the personal electric vehicle along the edge of a stream, lake or sea. Please do not attempt to drive the personal electric vehicle into or across water.



WARNING! Do not expose the personal electric vehicle to open flames.



ATTENTION! Keep your personal electric vehicle in a dry and clean environment. Don't take the personal electric vehicle to shower, bath, pool or sauna. Rain, snow, salt, fog and spray conditions, as well as frozen surfaces can cause personal electric vehicle screws and some fixtures to rust in untimely fashion.



ATTENTION! Avoid exposing the personal electric vehicle to prolonged excessively hot or cold environments. Excessive heat or cold may damage cushioned and non-cushioned parts of the chair, as well as the battery and battery components.



ATTENTION! Do not pull or drag the personal electric vehicle behind any vehicle. Dragging may exceed the chair's own speed threshold, causing damage to key parts.



ATTENTION! Be extremely careful when transporting an idle personal electric vehicle up and down stairs. To accomplish this, the personal electric vehicle should be folded and carried, requiring the participation of several physically capable people.



WARNING! Do not cross stairs or escalators with the personal electric vehicle.



WARNING! Do not sit on a personal electric vehicle while it is in any transport vehicles.



WARNING! For safer handling, be sure the power is off before moving/transporting the personal electric vehicle. Failure to do so may result in an accidental contact with the joystick that would cause the chair to move unexpectedly. Make sure the brakes are locked as well, to prevent the chair from moving during handling. This personal electric vehicle can be driven into an elevator, where you must turn off the power and sit firmly to ensure the personal electric vehicle will not move inside the elevator space.



WARNING! Do not place the folded personal electric vehicle on the front seat of a transporting vehicle as the chair may shift position and disturb the driver.



ATTENTION! Please contact your service provider if any spare parts on the seating systems are loose. Replace worn or damaged padding immediately.

WARNING! Radio wave sources such as radio and television stations, amateur radio transmission, two-way radios and mobile or cell phones can affect your personal electric vehicle control.

The following warnings should reduce the possibility of severe injury due to unintended braking or accidental movement of the personal electric vehicle:



1. Do not turn on portable personal communication devices such as citizen band (CB) radios and cell phones (mobile phones) when the personal electric vehicle is powered on.
 2. Pay attention to nearby transmitters such as radio or television stations and cell phone towers and try to avoid approaching them.
 3. In the event of unexpected movement or unanticipated brake release, the personal electric vehicle should be turned off as soon as is safely possible.
 4. Please note that adding accessories or parts or modifying your personal electric vehicle in any way may make it more susceptible to interference from radio wave sources. (Note: There is no easy way to assess the influences of such modifications on the chair's overall immunity from radio wave sources.)
- Do report all accidents involving unexpected movement or unanticipated brake release to the chair's manufacturer, noting and reporting nearby radio sources and other relevant information to the manufacturer as well.

3. STRUCTURE AND PERFORMANCE

3.1 Structure of the Journey Air

The main parts of this personal electric vehicle include the frame, two front wheels, two drive wheels, controller, motor with mechanism, armrests, push handles, backrest, seat base, footrest, battery case and charger. These parts are all identified and located in Fig. 1.

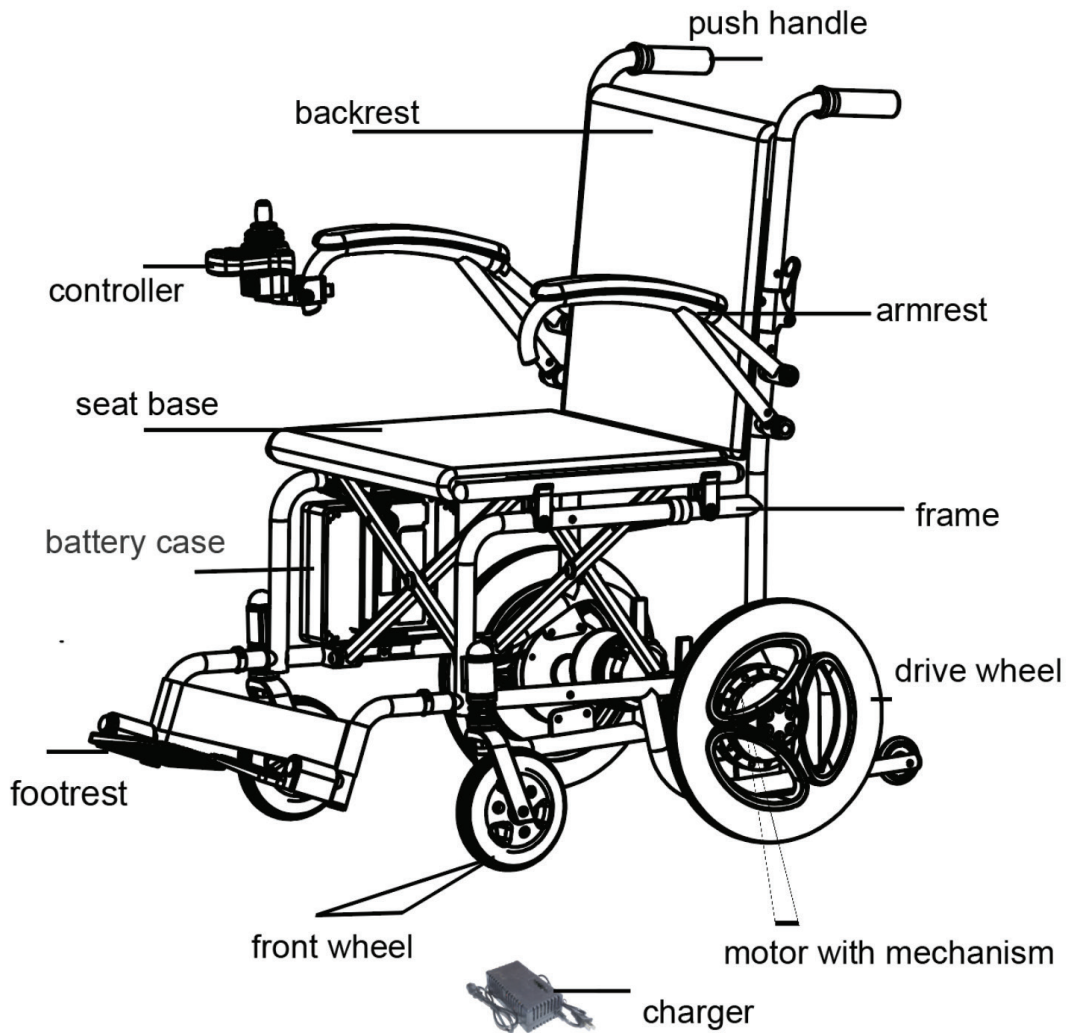

Fig. 1.

3.2 Product characteristics of the personal electric vehicle
Your personal electric vehicle has an internal power supply, an anti-shock classification, and a rated voltage and frequency of DC 24 V.

Fig. 2 below is an electrical diagram.

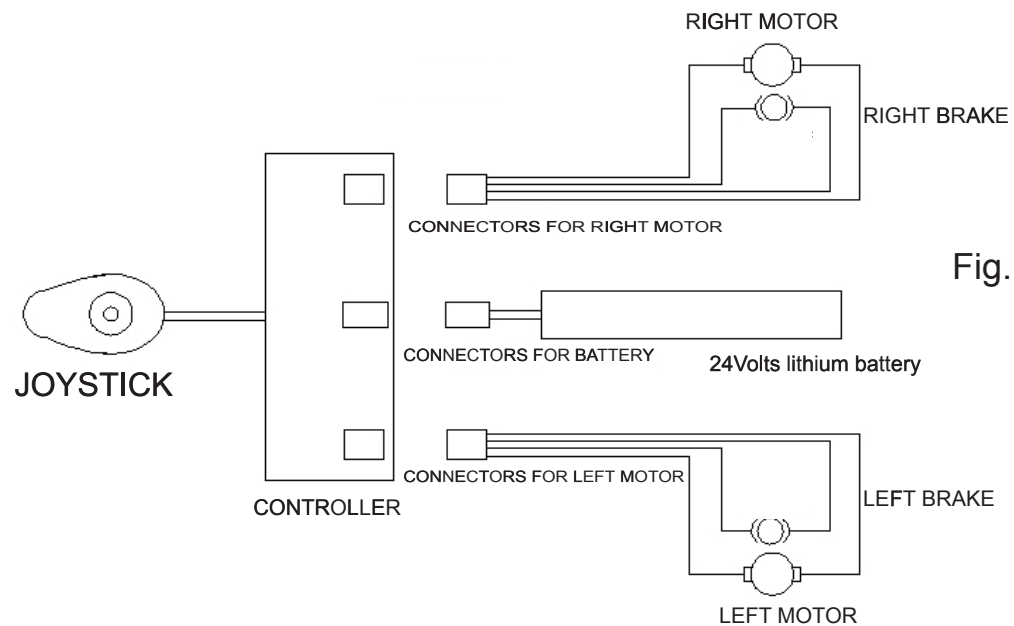

Fig. 2.

3.3 Product Software Version

Software Version of Journey Air 08643 is V1.0.

4. Specifications

The main specification includes dimension and weight.

Overall Dimensions	36.22 x 22 x 35 in
Seat Height	18 in
Seat Width	16.53 in
Seat Depth	15.74 in
Arm Height	9.84 in
Seatback Height	16.53 in
Personal Electric Vehicle Weight	37.47 lbs
Maximum Speed	≤ 2.8 mph
Braking Distance (on a level surface)	≤ 39.3 in
Minimum Turning Radius	≤ 35.4 in
Weight Capacity	240 lbs
Theoretical Travel Ranging	≥ 10 miles
Static Stability	$\geq 6^\circ$
Dynamic Stability	$\geq 3^\circ$
Slope Performance	6°
Climbing Ability	$\geq 3^\circ$
Motor Type	24V/150W*2
Lithium Battery Type	24V/6Ah
Max. Output Current of Controller	35A
Max. Output Current of Charger	2A
Front Wheel	Flat-Free Tire, O.D. 6 in
Rear Wheel	Flat-Free Tire, O.D. 12 in

Theoretical Travel Ranging is tested on flat road with average speed. It will vary due to drive surface, operation habits, etc.

5. Installation, Folding and Troubleshooting

5.1 Installation

5.1.1 Remove personal electric vehicle from packing box and set it on the ground. Push the chair frame apart to the left and right, and press the two tubes on both sides of the seat base down into the grooves on both sides of the frame (Fig. 2).

5.1.2 Pull up the handlebars and lock the folding device. (Fig. 3).

5.1.3 Put the controller on the armrest and pull down the tightening spanner on the controller to fasten and secure the controller (Fig. 4).

5.1.4 Install the footrests to the frame and fasten them down (Fig. 5).

5.1.5 Before powering the personal electric vehicle, the battery must be affixed onto the left frame. Set the battery upon the rail and press down to the bottom until you hear a “click” sound (Fig. 6).

5.1.6 Remove the anti-tipper assembly and insert it into the sleeve. Then affix it with the pin, aligning it to the hole (Fig. 7).

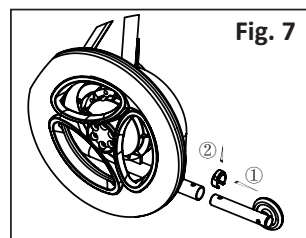
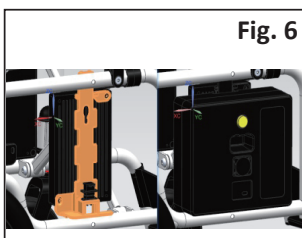
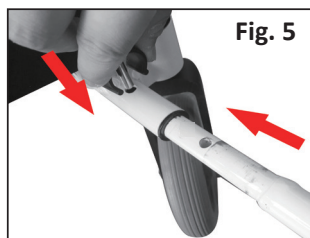

5.2 Folding and Storage

Please follow the instructions below if transporting or preparing the personal electric vehicle for storage.

1. Put the wheelchair on level ground and turn off the power supply.
2. Turn the footrest upwards by 90° (Fig. 8).
3. Press the buttons on both sides of the seatback to turn down the seatback (Fig. 9).
4. Pull up the seat cushion (Fig. 10) so that the chair frame can be folded from both sides, and pull up the two handle straps under the seat cushion (Fig. 11). Then turn on the switch button that will supply the power to the personal electric vehicle.

5.3 Troubleshooting Tips

5.3.1 When the brake lever has been moved upward and the personal electric vehicle is in electric mode, it cannot be pushed by hand. To push and move the personal electric vehicle, move the lever downward to manual mode (Fig. 13).

5.3.2 To turn on the battery indicator light, press the power switch on the joystick.

5.3.3 Rotate the joystick lever toward front to the end, observe the rotation of personal electric vehicle wheels, and then rotate other direction to observe if there is rotation for the wheels.

5.3.4 When you release the joystick lever, it will return to the middle position. At that point the wheels will have stopped turning.

5.3.5 The armrests can be flipped up—a more convenient position for getting on and off the personal electric vehicle (Fig. 12).



Fig. 8



Fig. 9



Fig. 10



Fig. 11



Fig. 12



Fig. 13

6. Use and Operation

6.1 Use

6.1.1 Controller: This is the key component of your personal electric vehicle. All the electronics for operating the chair are housed in this box (Fig. 16). Usually the controller is installed on one of the armrests and connected to the motor and the battery through the power box.



Fig. 16

- **Switch button:** This switch provides the power to the system that controls the personal electric vehicle's electronic equipment—the equipment that supplies the power for the chair's motor. Do not use the switch button to stop the chair unless in an emergency situation. Such misuse may shorten the life of the personal electric vehicle drive components.

----	0 - 2.8 mph
----	0 - 2.5 mph
----	0 - 2.2 mph
----	0 - 1.9 mph
----	0 - 1.6 mph

- **Joystick:** The joystick is used mainly to control the motion of the personal electric vehicle, including its speed and direction (forward, backward, left or right, etc.). The farther you push the joystick from its central position, the faster the personal electric vehicle moves. When you release the joystick, it will automatically return to the center position, and the brake will be automatically activated to stop the personal electric vehicle's movement.
- **Reversing alarm** can be shut off by pressing the buttons of speed-down and horn simultaneously for 3 seconds (Fig. 16). If need to turn it on, press the buttons of speed-up and horn for 3 seconds at the same time, and then the sound will be on.



WARNING! If your personal electric vehicle moves accidentally, please immediately release the joystick, and the chair will stop automatically.

- **Battery Charger:** This can be used with this personal electric vehicle only. Do not use the battery charger to supply power to any other electrical equipment; otherwise, the personal electric vehicle's control system or its E.M.C. (electromagnetic tolerance) performance may be damaged.



CAUTION!

If you connect any devices other than the supplied battery charger into the socket, causing damage to the control system, then the warranty is invalid.

6.1.2 Battery Charging and Use

If you will fully charge your new battery prior to its initial use, this first charge will bring the battery up to about 90% of its peak performance level.

Operate the personal electric vehicle at that level, checking the battery indicator light periodically, and when a re-charge is indicated, give the battery another full charge (for 6-8 hours) and operate the personal electric vehicle again. The battery will now be performing at over 90% of its potential. After four or five such charging cycles, the battery will top off at 100% charge and last for an extended period. Please replace the battery when necessary.



CAUTION!

Do not use your personal electric vehicle when the temperature is less than -77°F or above 122°F.

Battery specification	
Type	Lithium battery
Dimension	L x W x H: 18.8 x 5.3 x 16.5cm
Power	24V

6.1.3 Charging the battery

The battery charger is an important part of the personal electric vehicle operation. The off-board charger attached to the personal electric vehicle can charge the battery quickly and easily, preventing downtime or stress.



CAUTION!

The battery must be charged only by the manufacturer-supplied charger. Any other types of chargers could cause damage or injury.

6.1.4 Battery Removal

Press and hold the button and at the same time pull the battery box up to remove it (Fig.17).

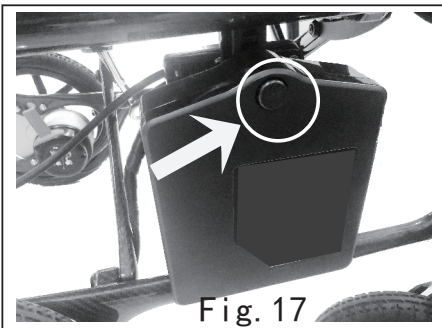

6.1.5 There are two methods for charging the battery: Method 1: Connect the charger to the charging port on the controller. Method 2: Remove the battery from the personal electric vehicle and charge it directly (Fig. 18).

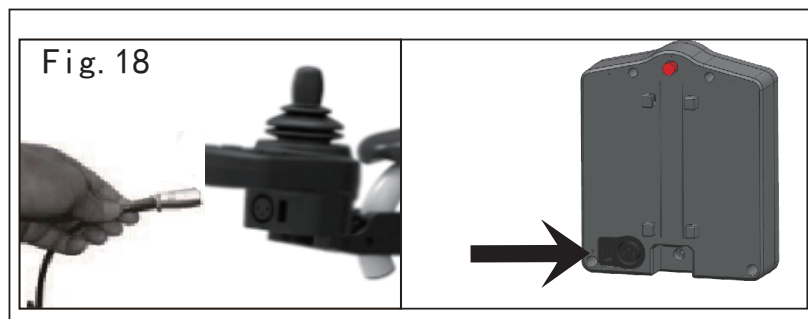

WARNING!



Please charge the battery at an environment temperature of 0-95°F . Charging at a lower/higher temperature could cause personal injury and battery damage.

6.1.6 Safety Belt

For your safety, the safety belt must be fastened before you drive the personal electric vehicle.



6.2 Operation

6.2.1 Preparations before operation

- Do not turn on the power switch when you're just using the personal electric vehicle to sit on, not to ride. Do not turn the power switch off as you're in the process of getting off the chair. Be sure it's turned off and in a full stop before you attempt to get off.
- Fold back the footrests first and then hold the armrest steady to sit on the personal electric vehicle. Do not get off the personal electric vehicle by stepping onto the footrests as that is dangerous and may cause the chair to overturn.

6.2.2 Practice before operation

- Find a spacious paved area with no traffic and have someone there to assist you as you first practice driving your personal electric vehicle. Practice until you feel confident enough that you can operate it safely and comfortably.
- Be sure to turn down the power when you go up or down an incline, and set an appropriate and comfortable speed using your speed adjustment button.
- We recommend that you set the electric personal electric vehicle at its lowest speed until you can operate it skillfully.
- To practice stopping (whether moving forward or backward), just push the handle.
- First, be sure that the personal electric vehicle is operating at the lowest speed when you practice driving it forward. After you've improved your skills, you can practice an "S" turn, meaning that you simply drive the chair through turns in the shape of a "S." Having mastered that, you can practice moving in reverse—again paying attention to your speed control setting. Your backward speed should always be lower than your forward speed.

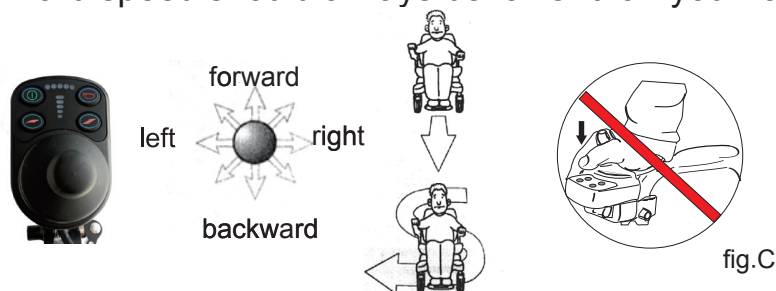

WARNING! When getting on and off the personal electric vehicle, be careful to avoid contact with the joystick to prevent setting the chair in motion and causing an accident.

6.2.3 Operation

Please note these precautions before operating personal electric vehicle:

WARNING! Do not use your personal electric vehicle when it is in manual mode UNLESS you have someone to assist you; otherwise, personal injury may result.

 **Do not put your personal electric vehicle in manual mode and attempt to move it by yourself when you are seated in the chair. Please ask an assistant to help you. Otherwise, personal injury may result.**

Do not put your personal electric vehicle in manual mode when it is located on an incline; otherwise the chair could go out of control and roll down the incline by itself, resulting in personal injury.

7. Glitch Diagnosis

This product has an automatic malfunction warning to give you a convenient alert that something is amiss. When there is a problem, the LEDs on the controller will flash with a horn alarm. You can find where the problem is located from information on the chart below.

2 Warning Tones & 1 Fault Sound	Communication failure; To check the wiring
2 Warning Tones & 2 Fault Sound	Failure of right motor or a poor connection of the related plug
2 Warning Tones & 3 Fault Sound	Failure of the right brake or a poor connection of the related plug
2 Warning Tones & 4 Fault Sound	Failure of the left motor or a poor connection of the related plug
2 Warning Tones & 5 Fault Sound	Failure of the left brake or a poor connection of the related plug
2 Warning Tones & 6 Fault Sound	The controller at the overcurrent, or the motor short-circuited or overloaded
2 Warning Tones & 7 Fault Sound	Failure of the controller lever, such as the lever failing to reset properly, or a poor connection
2 Warning Tones & 8 Fault Sound	Failure of the controller
2 Warning Tones & 9 Fault Sound	Battery voltage inadequate or battery fault

8. Safety devices and accident response

8.1 Overload protector: Refer to instruction manual 6.1.5

8.2 Safety belt: Refer to instruction manual 6.1.6

8.3 Please release the joystick whenever there is a personal electric vehicle problem, and the personal electric vehicle will then stop.

9.1 Maintenance

Like other motorized vehicles, your personal electric vehicle requires routine maintenance. Some checks and maintenance you can perform yourself; others will require assistance from your service agent. Preventive maintenance is very important. If you perform the maintenance and checkups in this section, your personal electric vehicle will give you years of trouble-free operation. If you have any questions or doubts about your personal electric vehicle's care or operation, please contact your service agent or our after-sale service department.

9.1.1 Humidity

Your personal electric vehicle, like most electrical and mechanical equipment, is susceptible to external conditions. In any case, do not expose the personal electric vehicle to a damp environment. Direct or prolonged exposure to water or dampness could cause the personal electric vehicle electronic and mechanical malfunction. Water can expose both the chair's electrical components and the chair's frame to corrosion.

9.1.2 Temperature

- Some parts of your personal electric vehicle are susceptible to temperature extremes.
- In extremely cold temperatures, the battery can become frozen, including battery components (sealed lead-acid batteries or gel batteries). Extreme temperatures may cause some other components to freeze up, too, such as the charger.
- Temperature above 131°F may cause a reduction in your personal electric vehicle's speed.

9.1.3 General Guidelines

- Avoid abusing the controller, especially the joystick. Treat your personal electric vehicle well, and it will have a long life.
- Avoid prolonged exposure of your personal electric vehicle to extreme weather conditions, such as extreme heat, cold or a moist environment.
- Keep the controller clean and dry.
- Check all electric connections periodically, including the cable and charger connectors, ensuring that they are all tight and secure.
- If there are only red LEDs showing on the Battery Gauge lights, then the batteries are close to running out of charge. Recharge the batteries as soon as possible. We recommend charging the battery for 8-12 hours.
- Check the inflation of the rear tires, and if the inflation seems insufficient, they should be inflated as soon as possible.
- The frame surface has been sprayed with a clear sealant coating. You can apply a light coat of car wax to help the surface keep a high gloss.
- Check all your cable connections, ensuring that they are fastened and not corroded. The battery must be contained in the battery area, fully in place and flat, with the battery plug inward.
- All wheel bearings have been lubricated and sealed. There is no need for further lubrication.
- Check for loose parts in the wheel hub, drive device and in the chair itself. If anything appears to be loose, please screw it tightly in place as soon as possible.

9.1.4 Maintenance after use

- Turn off the power when the chair is not in use, and disconnect all the connectors if the personal electric vehicle will not be in use for a long time.
- Children, people who are drinking, those who suffer from blackouts, and others ineligible to drive a car should also not drive your personal electric vehicle.
- Store the personal electric vehicle in normal temperatures to prevent damage, so that it will perform at top level for a long time.
- Clean the personal electric vehicle with a clean, soft, damp cloth and dry it thoroughly. Never use any chemicals to clean it, as discoloration may result.
- Remove the cloth cover of the seat backrest and wash it when it becomes soiled; then dry it for reuse.

9.1.5 Daily Checks

In order to keep your personal electric vehicle in good condition, you should check it out before each use. To maintain the proper weekly, monthly, semi-annual checkups, see the chart below.

Components to Inspect	At any time	Weekly	Monthly	Six monthly
All parts			●	
Joystick	●			
Brake System	●			
Connection		●		
Battery Condition	●			
Tire Condition			●	
Frame Condition				●
Front Wheel Condition		●		
Overall Condition				

9.1.6 Cleaning

Clean the personal electric vehicle as below:

- Never wash your personal electric vehicle with water or expose directly to water.
- Since the surface of the chair's frame has been coated with a protective coating, it is very easy to wipe it clean with a damp cloth. Never use any chemicals to clean the vinyl on the seat and armrests, as chemicals may make them slippery and cause them to become rough. Just use a damp cloth and soapy water to clean them, and then them dry thoroughly.

10. Storage

Your personal electric vehicle should be stored in a dry environment free from sources of extreme temperature and dampness. Remove the battery from the personal electric vehicle prior to storage; otherwise the frame may rust and the electronics may be damaged.

11. Opening and Checking

Open the packing box and check to determine whether anything is missing or damaged.

Packing List

No.	Name	Quantity	Remark
1	Journey Air	1pc	08643
2	Charger	1pc	Model: 24V/2A QL-09005-B2402000F
3	Instruction Manual	1pc	
4	footrest	2pc	
5	Controller	1set	

12. Limited 12 Month Warranty

Journey Health & Lifestyle warrants the frame, mechanical and electrical components including the motor to be free from defects in materials and workmanship for a period of twelve (12) months from the original purchase date. The originally supplied battery, tires, fabric seat and seat back and the seat cushion are all warranted to be free from defects in materials and workmanship for a period of six (6) months from the original purchase date. If within such warranty period any such component or part shall be proven to Journey Health & Lifestyle's satisfaction to be defective, the product shall, at Journey Health & Lifestyle's option, be repaired or replaced with new or refurbished product components. In some cases an installation kit may be provided to the owner to facilitate installation of a replacement product component. This warranty does not provide for any labor charges incurred in product component installation. The warranty period of the repaired or replaced product shall terminate with the termination of the warranty period for the original product. Journey Health & Lifestyle's sole obligation and your exclusive remedy under this warranty shall be limited to such repaired or replaced product. Contact Journey Health & Lifestyle before sending any product for warranty repair or replacement. Do not send any product without the prior consent of Journey Health & Lifestyle.





Limitations and Exclusions:

This warranty does not cover damage, deterioration or malfunction resulting from accident, negligence, misuse, abuse, use by combined rider plus cargo weight above that specified in this User Manual; improper storage; the normal gradual reduction in battery performance due to heavy use; improper operation or failure to follow instructions according to this User Manual; damage in shipment of the product (claims must be presented to the carrier); repair, attempted repair or modifications made by anyone other than Journey Health & Lifestyle; any unit on which the serial number has been defaced, modified or removed; normal wear items including but not limited to inner tubes and grips; any periodic maintenance; deterioration due to perspiration, corrosive atmosphere or ground covering such as pine needles or crushed limestone dust, or other external causes such as punctures, extremes in temperature and humidity; damages related to lightning, flood or circumstances beyond Journey Health & Lifestyle control; or products subjected to commercial or institutional use.

This warranty applies in North America only and is extended only to the original purchaser of the Journey Air or Journey Air Elite product when purchased directly from Journey Health & Lifestyle (USA) or its authorized distributors and is nontransferable. If you purchased a Journey Air or Journey Air Elite from one of Journey Health & Lifestyle's authorized dealers, your first remedy for warranty claims is through the dealer from which the Journey Air or Journey Air Elite was purchased. This warranty gives you specific legal rights and you may also have other legal rights which may vary from place to place.

The foregoing warranty is exclusive and in lieu of all other express warranties, implied warranties, if any including but not limited to the implied warranties of merchantability and fitness for a particular purpose, and shall not extend beyond the duration of the express warranty provided herein. Journey Health & Lifestyle shall not be liable for any consequential or incidental damages whatsoever and disclaims any liability beyond the initial purchase price of the Journey Air or Journey Air Elite product.

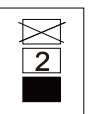
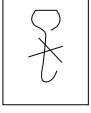
The name and symbols of the signs

No.	Sign	Meaning
1		Fragile objects inside this package. Please handle with care.
2		Keep the package upright during transporting and delivery
3		Avoid exposing the package to rain or other precipitation.
4		Do not stack more than two of these packages, one above the other.
5		Do not use hand hooks to carry or transport this package.
6		Application type B
7	IPX1	Avoid temperatures conducive to condensation; moisture could damage electrical contents.
8		ATTENTION!



 **journey**
HEALTH & LIFESTYLE

 **journey**
air

If you have any questions, call us at our toll free number:

1-800-958-8324