

THREADED FLOW THRU DIAPHRAGM SEAL

Reotemp's Threaded Flow Thru Diaphragm Seals are ideal for installation in applications requiring little interruption to process flow. It is available in threaded connections up to 2" NPT.



W540

FEATURES / BENEFITS

- Welded Diaphragm for Maximum Durability
- Wide Variety of Diaphragm and Material Options
- Continuous Flow Design Reduces Clogging Potential; Ideal for Slurries or High Viscosity Fluids
- Easy Cleanout of Diaphragm Cavity without Compromising Filled System

SPECIFICATIONS

| | |
|----------------------|---|
| Diaphragm | 316SS, Hast C-276, Tantalum, Monel, or others |
| Lower Housing | 316SS, Hast C-276, Monel, or others |
| Gasket | PTFE, Grafoil, or Klinger |
| Upper Housing | 316SS Standard |

Process

Temperature Limits

| | | W540 |
|----------------|----------------|------------|
| Metallic Lower | PTFE Gasket | -110/350°F |
| | Klinger Gasket | -110/450°F |
| | Grafoil Gasket | -40/600°F |

Ambient Temperature Limits Determined by the pressure instrument.

Minimum

Recommended Span

| | | W540 |
|---|--|------------------------------------|
| 2.5" & 3.5" Gauges | | 15 psi |
| 4", 4.5", & 6" Gauges | | 30 psi |
| Transmitter (Gauge Pressure) | | 150" H ₂ O |
| Transmitter (Differential Pressure) | | 300" H ₂ O _d |
| Differential Pressure Gauge (D40/42 Only) | | N/A |

Maximum Working Pressure at 100°F:

| | Bolts | Grade 5 | Grade 8 | 18/8SS | 316SS |
|----------------|-------|-----------|-----------|-----------|-----------|
| Metallic Lower | W540 | 2,500 psi | 2,500 psi | 1,500 psi | 1,500 psi |

Weight

| | |
|----------------|---------|
| Metallic Lower | 4.5 lbs |
|----------------|---------|

THREADED FLOW THRU DIAPHRAGM SEAL

HOW TO ORDER: Choose options to build a part number. For example: **W540T1XXXSSS-SKDTD-AS-PP**

| SEAL TYPE | INSTRUMENT CONNECTION | SEALING TYPE | PIPE SIZE | MUST INCLUDE | DIAPHRAGM MATERIAL | LOWER HOUSING | UPPER HOUSING |
|--|--|---------------------|---|--------------|---|---|--|
| W540 = Threaded Flow Thru Welded Diaphragm Seal | 2 = 1/2" FNPT 4 = 1/4" FNPT W = Low Volume Transmitter Connection | T = Threaded | 0 = 1/2" T = 3/4" 1 = 1" H = 1.5" 2 = 2" | XXX | S = 316SS U = Tantalum M = Monel (A400) D = Carpenter 20 H = Hast C-276 Y = Inconel (625) N = Nickel (201) 2 = Duplex (2205) J = Titanium* *Requires Titanium Upper Housing Wetted | S = 316SS M = Monel (A400) D = Carpenter 20 H = Hast C-276 Y = Inconel (625) N = Nickel (201) 2 = Duplex (2205) J = Titanium Wetted | S = 316SS F = 304SS J = Titanium* *Requires Titanium Diaphragm |

DIAPHRAGM SEALS

| BOLTING | GASKET | INSTRUMENT MOUNT | SYSTEM FILL FLUID | OPTIONS |
|---------|--------|------------------|-------------------|---------|
|---------|--------|------------------|-------------------|---------|

-8 = Carbon Steel (Grade 8)
-T = Stainless Steel (18/8)
-S = Stainless Steel (316)

K = Klinger (C-4401)
T = PTFE
G = Grafoil

Direct Mount
DTD = Direct Mount, Threaded
DWD = Direct Mount, Welded
RTR = 6" Cooling Tower
STW = 3" Cooling Standoff
Remote Mount
A?? = Armored Capillary, Threaded
B?? = Armored Capillary, Welded
P?? = PVC Coated Armor, Threaded
W?? = PVC Coated Armor, Welded

Note: ?? = Length in feet (e.g. 05 = 5 feet)

Tree Mount
LVC = Low Volume Goal Post Assembly; Vertical Mount; Gauge/Switch
MVG = Compact Tree Assembly; Vertical Mount; Gauge/Switch
YYY = Dry Seal, No Instrument

See Page 61 for Complete Mounting Guide

Common Fills
-AS = Silicone DC200
-AG = Glycerin USP
-BP = Propylene Glycol
-XX = No Fill Fluid

See Page 64 for Complete Fill Guide

-PP = Pulse Plus™ (Pulsation Protection)
-OX = Cleaned for Oxygen Service
-AU = Gold-Plated Diaphragm
-TC = Teflon-Coated Diaphragm
-TS = SS Tag (1-10 Character)
-PM = Positive Material Identification Certification
-MR = Mill Test Report
-HT = Hydrostatic Test per ASME B31.3

SMART TRANSMITTER ATTACHMENT

HOW TO ORDER: Unbalanced System Example

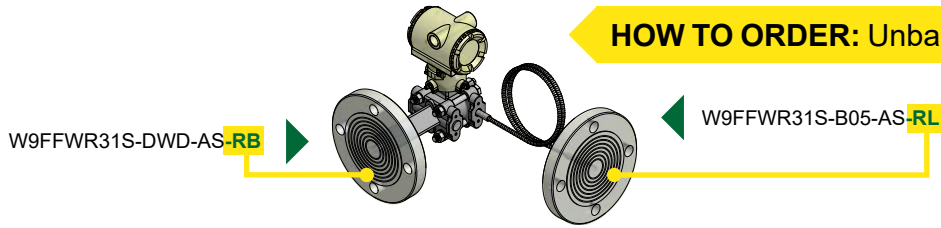

DIFFERENTIAL PRESSURE ASSEMBLY

Balanced System A complete assembly with one part number that includes two diaphragm seals, two capillaries, two fills, and one complete assembly calibration certificate.

Unbalanced DP System Where seal, mount, capillary, or fill is not identical. A complete assembly includes one diaphragm seal on the HP side AND one diaphragm seal on the LP side.

DIAPHRAGM SEALS

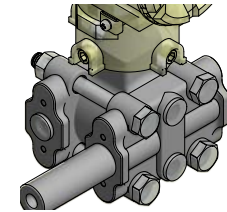
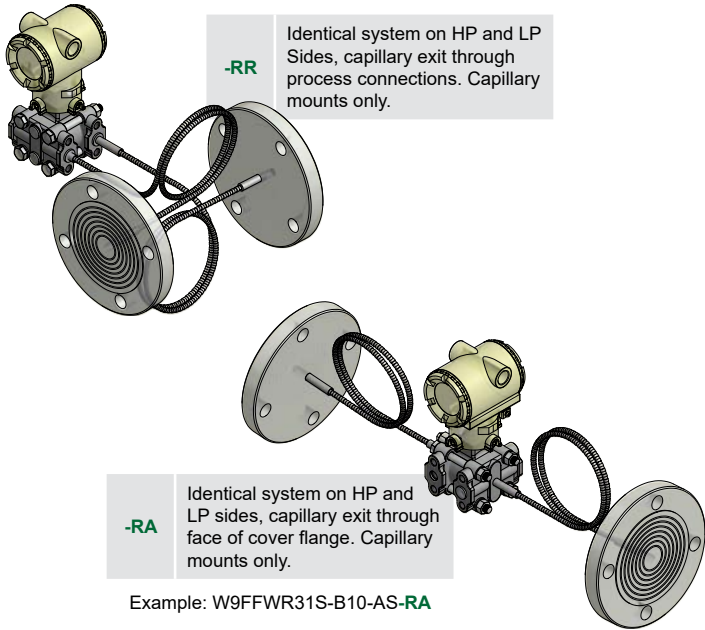

-RH Mount via Process Connections
Side High Pressure

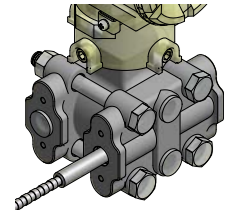

-RL Mount via Process Connections
Side Low Pressure

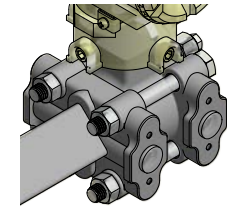

-RB Mount via Face of Cover Flange
Side High Pressure

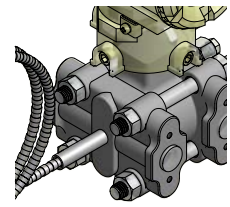

-RC Mount via Face of Cover Flange
Side Low Pressure

GAUGE PRESSURE ASSEMBLY

In Line Pressure Transmitter

Traditional Mount for Gauge Pressure Seal mount on one side only, other side is vented.



-R1 Mount to In-Line Gauge Pressure Transmitter. Direct or remote mount.

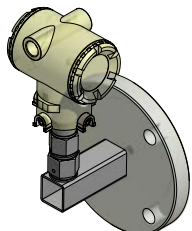

-R4 Horizontal Mount (Tank Mount) to In-Line Gauge Pressure Transmitter. Direct mount only.

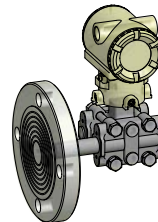

-R2 Instrument mount through process connections, HP Side. Use "R3" if mounting to LP side

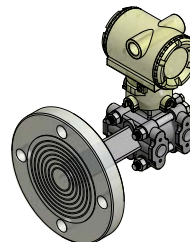

-R8 Instrument mount through face of cover flange, HP Side. Use "R9" if mounting to LP Side

DIAPHRAGM SEAL ASSEMBLY TO SMART TRANSMITTERS

Reotemp specializes in the unique craft of assembling diaphragm seals to field transmitters for the purpose of measuring pressure, differential pressure, level, and flow. As a trusted supplier to many of the world's leading transmitter manufacturers, Reotemp can assemble a diaphragm seal system to virtually any make or model transmitter. Every transmitter mount includes the features below to ensure superior performance and durability for every assembly. Reotemp also offers repair, refurbishment or replacement of used transmitters with remote seals.

STANDARD FEATURES ON ALL REOTEMP ASSEMBLIES

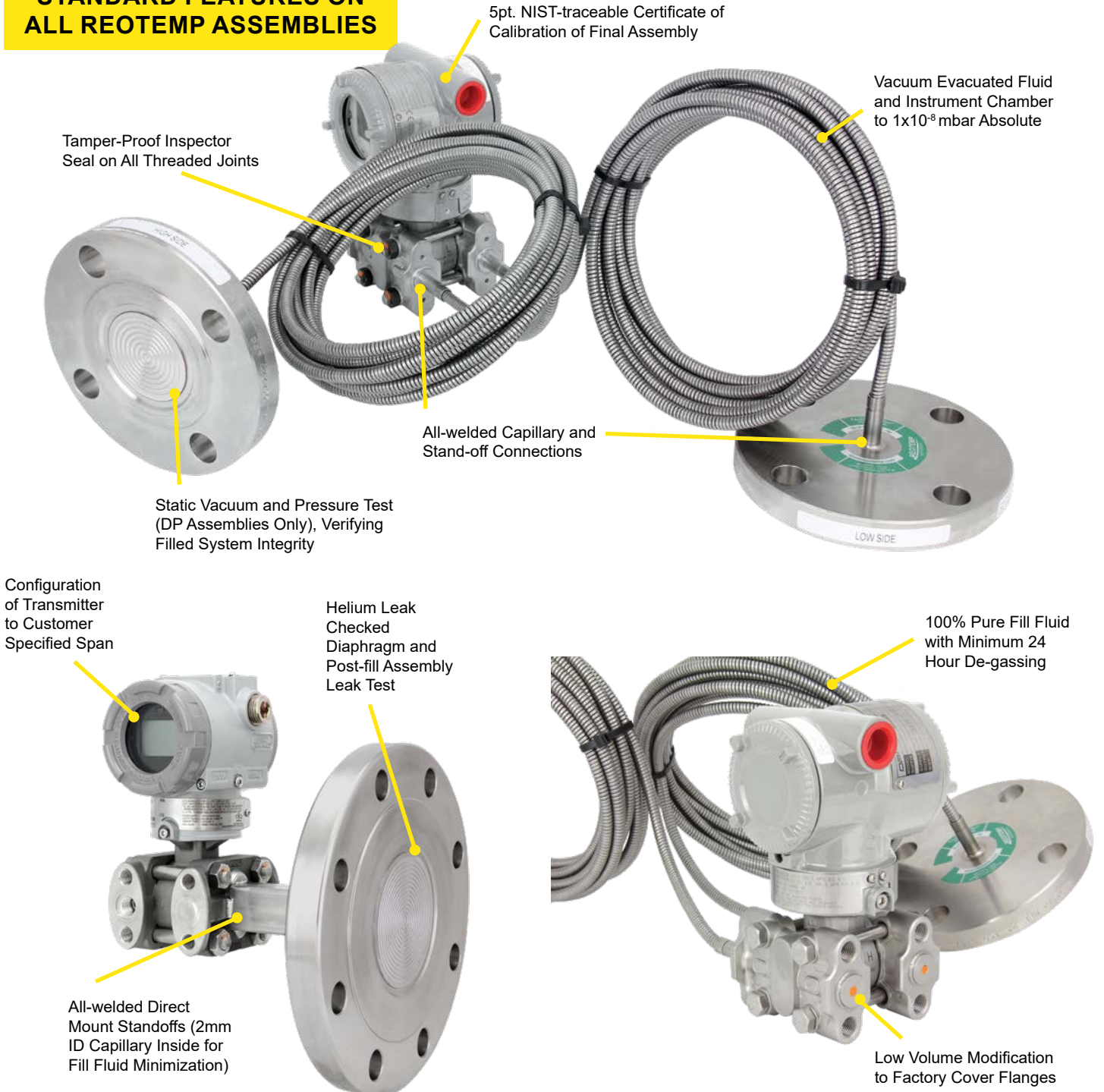

INSTRUMENT MOUNTING CONFIGURATIONS

DIRECT MOUNT

Direct Mounting a pressure gauge, switch, or transmitter is the most common diaphragm seal assembly.

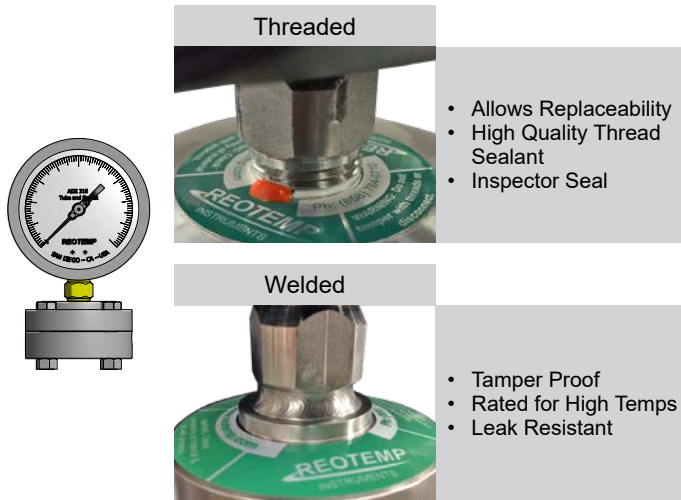

- Allows Replaceability
- High Quality Thread Sealant
- Inspector Seal

- Tamper Proof
- Rated for High Temps
- Leak Resistant

| Code | Description | Max. Temp |
|------|--------------------------------|-----------|
| -DTD | Threaded Instrument Connection | 400°F |
| -DWD | Welded Instrument Connection | 600°F |

Assembly Notes: Welded connection recommended for pressure exceeding 1,500 psi for purposes of leak prevention.

COOLING ELEMENTS

Used in either high temp or cold temp applications, Cooling Elements mounted above diaphragm seals quickly normalize fluid temperature toward ambient. This protects the pressure instrument while still maintaining the convenience of a direct mount.

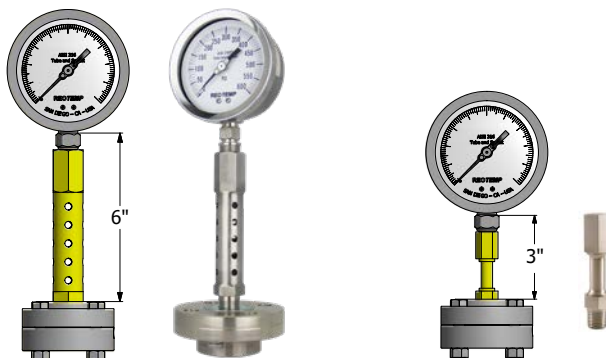

-RTR

-STW

| Code | Description | Max. Temp |
|------|---------------------|-----------|
| -RTR | 6" Cooling Tower | 750°F |
| -STW | 3" Cooling Standoff | 600°F |

Assembly Notes: Cooling elements are welded to diaphragm seal. Instruments are threaded to cooling element unless specified. All lengths are nominal.

REMOTE MOUNT

Remote Mounting a pressure instrument using flexible capillary is a common mounting method when the point of measurement is in a hazardous or inconvenient location.

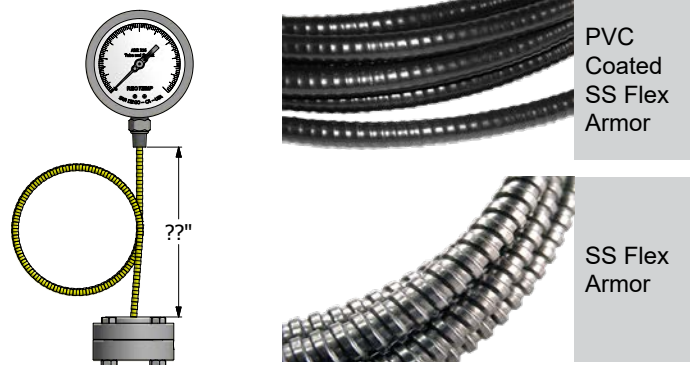

| Code | Description | Max. Temp |
|------|---------------------------------------|-----------|
| -P?? | PVC Coated SS Armor, Threaded to Seal | 400°F |
| -W?? | PVC Coated SS Armor, Welded to Seal | 600°F |
| -A?? | SS Flexible Armor, Threaded to Seal | 400°F |
| -B?? | SS Flexible Armor, Welded to Seal | 750°F |

Note: ?? = Length in feet (e.g. 05 = 5 feet)

Assembly Notes: Capillary has a 2mm inner diameter unless specified differently by customer. Ambient temp limit of PVC coated armor is 250°F. Standard instrument connection is threaded (Smart Transmitters are welded), unless specified by customer.

TREE ASSEMBLIES

Tree Assemblies offer the ability to mount two pressure instruments onto one diaphragm seal, allowing the user to gain both a local indication and a remote signal without adding an additional pipe insertion.

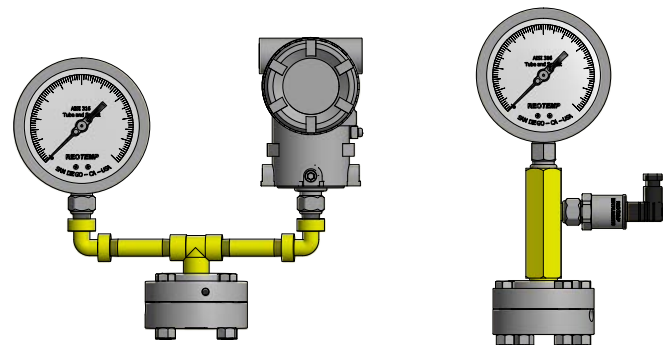

-TRE & -TRX

-TRM

| Code | Description | Max. Temp |
|------|---|-----------|
| -TRE | Goal Post, Low Pressure Assembly (Max. 150 psi) | 400°F |
| -TRX | Goal Post, Heavy Duty (Max. 3,000 psi) | 600°F |
| -TRM | Compact Tree Assembly (Max. 3,000 psi) | 600°F |

Assembly Notes: Threaded joints are fully welded for consistent instrument orientation. Instrument connections are threaded unless specified by customer. Diaphragm seal must displace enough fluid to drive both instruments.

FILL GUIDE

Diaphragm seals are designed to protect pressure instruments from hot process media and corrosive chemicals while minimizing any negative effect on instrument accuracy and durability. A well-made diaphragm seal can achieve this goal only if it is properly assembled, filled, and tested. Reotemp's highly trained technicians use state-of-the-art equipment so that every diaphragm seal assembly is filled and tested to assure optimal instrument performance:

- ✓ 24-hour Minimum Fluid De-gassing
- ✓ Evacuated Instrument Chamber Up to 10⁻⁸ mbar Absolute
- ✓ Complete Fill Integrity Check
- ✓ Fill-port Leak Test
- ✓ Post-fill Static Test
- ✓ Verification of Instrument Calibration
- ✓ High-temp Pipe Sealant Used on All Threaded Joints
- (Welded Joints Upon Request)
- ✓ Tamper-proof (Inspection Seal) Lacquer used on All Threaded Joints
- ✓ Sturdy Diaphragm Packaging Protection



| Part Number Code | Name | Description | Temperature Range (Vacuum Service <5psia) | Pulse+™ | Viscosity cst @ ~77°F | Specific Gravity @ ~77°F | Thermal Expansion cc/cc°C |
|--|------------------------------|---|---|---------|-----------------------|--------------------------|---------------------------|
| STANDARD FILL FLUID | | | | | | | |
| AS | Silicone DC200 ¹ | This is the standard fill fluid for most diaphragm seal applications. | -40°F to 400°F (-40°F to 250°F) | Yes | 20 | 0.94 | .00104 |
| HIGH TEMP SILICONE | | | | | | | |
| BH | Silicone DC704 ¹ | Standard for Smart Transmitters and capillary systems. Performs well in applications with high temperature and a deep vacuum. | 0°F to 650°F (0°F to 450°F) | No | 44 | 1.07 | .00077 |
| B1 | Silicone DC710 ¹ | Highest temperature rating; ideal for gauge seal assemblies. Too thick for capillary assemblies. Response time can become very slow in cold conditions. | 50°F to 750°F (50°F to 400°F) | Yes | 500 | 1.11 | .00043 |
| C8 | Syltherm 800 ² | Low viscosity allows it to perform well in both low and high temperatures. Not recommended for vacuum service or at high temperatures when under low static pressure. | -40°F to 750°F (-40°F to 150°F) | No | 9.5 | 0.93 | .00136 |
| B5 | Silicone DC705 ¹ | Performs very well in high temperatures when under vacuum. The high viscosity and freezing point of this fluid makes it a poor choice for cold or outdoor installations without heat tracing. | 50°F to 675°F (50°F to 550°F) | Yes | 175 | 1.09 | .00096 |
| B2 | Silicone DC550 ¹ | Similar high temperature performance as DC705, however it performs better at lower temperatures. | -40°F to 575°F (-40°F to 400°F) | No | 125 | 1.07 | .00076 |
| FOOD GRADE | | | | | | | |
| AG | Glycerin USP | This is the standard fill fluid for most gauge seal assemblies for food, beverage, and pharmaceutical applications. Its high viscosity will cause very slow response at times in low temperature and outdoor installations. | 60°F to 450°F (Not Suitable) | Yes | 1100 | 1.26 | .00061 |
| BN | NEOBEE M20 ⁷ | Low viscosity and a wide temperature range makes this the standard sanitary fill fluid for Smart Transmitters and capillary systems. | -10°F to 400°F (-10°F to 200°F) | No | 10 | 0.92 | .00101 |
| BS | Food Grade Silicone | Highest temperature limit for food grade fluids. Because of its high viscosity it does not perform well in low temperatures. | 20°F to 550°F (20°F to 250°F) | Yes | 350 | 0.97 | .00096 |
| BP | Propylene Glycol | This is the fill fluid used when Glycol is called for on the customer specification. It has a very narrow temperature range. | 0°F to 200°F (Not Suitable) | No | 2.85 | 1.03 | .00073 |
| INERT (TYPICALLY FOR CHLORINE AND OXYGEN APPLICATIONS OR IN SILICONE-FREE ENVIRONMENTS) | | | | | | | |
| C1 | Fomblin Y06 ⁴ | Ideal inert fluid for transmitter applications. Relatively high vapor pressure above 200°F. Not recommended for use in high temperature situations with low static pressure. | -40°F to 450°F (0°F to 250°F) | No | 71 | 1.88 | .00086 |
| C2 | Halocarbon 6.3 ³ | Standard inert fluid used in gauge seal assemblies. | -40°F to 400°F (-40°F to 200°F) | Yes | 6.3 | 1.87 | .00084 |
| C3 | Halocarbon 1.8 ³ | Typically used in low temperature applications because of its low viscosity. | -110°F to 220°F (-100°F to 100°F) | No | 1.8 | 1.82 | .00084 |
| C4 | Fluorolube FS-5 ⁵ | Similar performance to Halocarbon 6.3, however not suitable for vacuum service. | -40°F to 450°F (Not Suitable) | No | 5 | 1.86 | .00087 |
| SPECIALTY | | | | | | | |
| CK | Krytox 1506 ⁶ | Specialty fill fluid, inert. | -40°F to 350°F (-40°F to 300°F) | No | 62 | 1.88 | .00095 |
| BE | Ethylene Glycol | Occasionally used in annular (O-ring) seal assemblies. | -25°F to 320°F (Not Suitable) | No | 30 | 1.10 | .00062 |

1 Trademark Dow Corning

3 Trademark Halocarbon Product Corporation

5 Trademark Hooker Chemical Company

7 Trademark Stepan Specialty Products

2 Trademark The Dow Chemical Company

4 Trademark AUSIMONT S.P.A

6 Trademark The Chemours Company FC, LLC

Note: PulsePlus™ fill fluids may have different physical properties than specified. Chemical composition and temperature ranges do not vary.

DIAPHRAGM SEAL OPTIONS



Visit reotemp.com

- ✓ Check Stock
- ✓ Get Price
- ✓ Configure Part #
- ✓ Download PDF Data Sheets

DIAPHRAGM SEALS

| | | MS4 MS6 MS8 | W5 W6 W7 | T5 T6 V5 | W9FF W9FR | W9XT | W9FP | DSTC75 | DSTC15 AND LARGER | DSTF05 | DSTF75 AND LARGER | OR | DXFR |
|--|--|-------------------|----------------|----------------|--------------|------|------|--------|-------------------------|--------|-------------------------|-----|------|
| PULSATION PROTECTION (ONLY AVAILABLE WITH REOTEMP PRESSURE GAUGE MOUNTED TO SEAL) | | | | | | | | | | | | | |
| -PP | Pulse Plus™ | ✓ | ✓ | ✓ | ✓ | ✓ | N/A | N/A | ✓ | N/A | ✓ | ✓ | N/A |
| DIAPHRAGM COATING | | | | | | | | | | | | | |
| -AU | Gold Plated Diaphragm | N/A | ✓ | N/A | ✓ | ✓ | ✓ | ✓ | ✓ | ✓ | ✓ | N/A | N/A |
| -TC | Teflon Coated Diaphragm PTFE | N/A | ✓ | N/A | ✓ | ✓ | ✓ | N/A | ✓ | N/A | ✓ | N/A | N/A |
| -EP | Electropolished Diaphragm | N/A | N/A | N/A | N/A | N/A | N/A | ✓ | ✓ | ✓ | ✓ | N/A | N/A |
| FILL | | | | | | | | | | | | | |
| -FW | Fill Port Welded Closed | STD ¹ | ✓ | ✓ | ✓ | ✓ | ✓ | ✓ | ✓ | ✓ | ✓ | N/A | N/A |
| -VF | Fill for Vacuum Service | N/A | ✓ | N/A | ✓ | ✓ | ✓ | N/A | ✓ | N/A | ✓ | N/A | N/A |
| CLEANING AND FINISH | | | | | | | | | | | | | |
| -DG | Degreased, Shipped in Sealed Bag | ✓ | ✓ | ✓ | ✓ | ✓ | ✓ | ✓ | ✓ | ✓ | ✓ | N/A | ✓ |
| -OX | Cleaned for Oxygen Service per ASME B40.1 | ✓ | ✓ | N/A | ✓ | ✓ | ✓ | ✓ | ✓ | ✓ | ✓ | N/A | ✓ |
| -OY | Cleaned for Oxygen Service per MIL-STD-1330D | ✓ | ✓ | N/A | ✓ | ✓ | ✓ | ✓ | ✓ | ✓ | ✓ | N/A | ✓ |
| PLUG FOR FLUSH PORT | | | | | | | | | | | | | |
| -GS | 1/4" SS Plug Installed | STD | STD | STD | N/A | N/A | N/A | N/A | N/A | N/A | N/A | N/A | ✓ |
| -JS | 1/2" SS Plug Installed | N/A | STD | STD | N/A | N/A | N/A | N/A | N/A | N/A | N/A | N/A | ✓ |
| -GH | 1/4" Hast C Plug Installed | ✓ | ✓ | ✓ | N/A | N/A | N/A | N/A | N/A | N/A | N/A | N/A | ✓ |
| -JH | 1/2" Hast C Plug Installed | N/A | ✓ | ✓ | N/A | N/A | N/A | N/A | N/A | N/A | N/A | N/A | ✓ |
| -GM | 1/4" Monel Plug Installed | N/A | ✓ | ✓ | N/A | N/A | N/A | N/A | N/A | N/A | N/A | N/A | ✓ |
| -JM | 1/2" Monel Plug Installed | N/A | ✓ | ✓ | N/A | N/A | N/A | N/A | N/A | N/A | N/A | N/A | ✓ |
| TAG OPTION | | | | | | | | | | | | | |
| -TS | Stainless Steel Tag (1-10 Characters) | | | | | | | | ✓ | | | | |
| -TM | Stainless Steel Tag (11-80 Characters) | | | | | | | | ✓ | | | | |
| -TP | Paper Tag | | | | | | | | ✓ | | | | |
| CERTIFICATION OPTIONS | | | | | | | | | | | | | |
| -NC | Certificate of NACE Compliance | ✓ | ✓ | N/A | ✓ | ✓ | ✓ | N/A | N/A | ✓ | ✓ | N/A | ✓ |
| -CM | General Material Conformance | ✓ | ✓ | ✓ | ✓ | ✓ | ✓ | ✓ | ✓ | ✓ | ✓ | ✓ | ✓ |
| -MR | MTR - Mill Test Report Certificate | ✓ | ✓ | ✓ | ✓ | ✓ | ✓ | ✓ | ✓ | ✓ | ✓ | N/A | ✓ |
| -PM | PMI - Positive Material Identification Certificate | ✓ | ✓ | ✓ | ✓ | ✓ | ✓ | ✓ | ✓ | ✓ | ✓ | N/A | ✓ |
| -HT | Hydrostatic Test per ASME B31.3 | ✓ | ✓ | ✓ | ✓ | ✓ | ✓ | ✓ | ✓ | ✓ | ✓ | N/A | N/A |
| -HL | Helium Leak Test Certificate | ✓ | ✓ | N/A | ✓ | ✓ | ✓ | ✓ | ✓ | ✓ | ✓ | N/A | N/A |

✓ Indicates that the option is available
 N/A Indicates the option is not available

¹ Standard on MS8, available on MS4 & MS6.