

# Byggeveiledning

# Deleliste



4 stk  
nylonskruer  
m3x8



3 stk  
nylonskruer  
m3x12

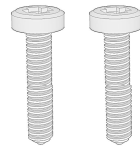

2 stk  
nylonskruer  
m3x18

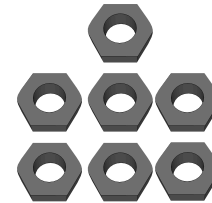

7 stk  
nylonmuttere  
m3

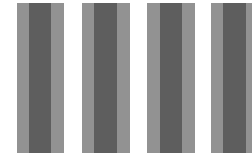

4 stk  
avstandstykker  
m3x20

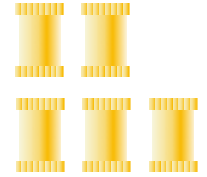

5 stk  
ruglete  
tønnemuttere

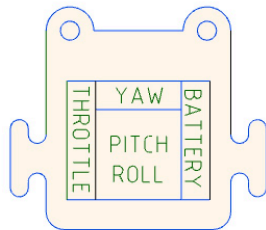

fjernkontroll-  
holder

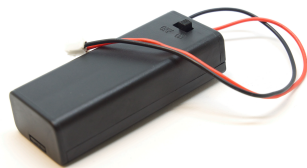

1 stk  
batteriboks



1 stk  
stor gummiring

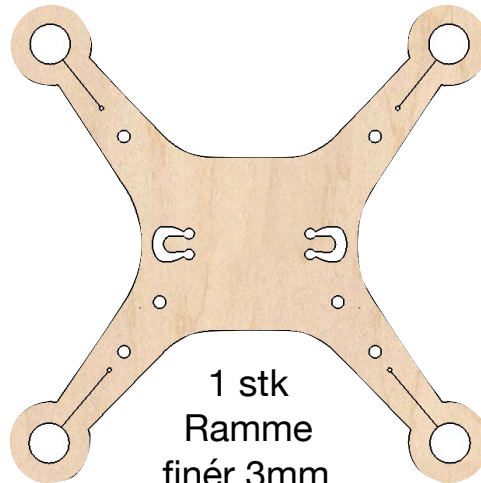

1 stk  
Ramme  
finér 3mm



1 stk Lithium  
(LiPo)-batteri

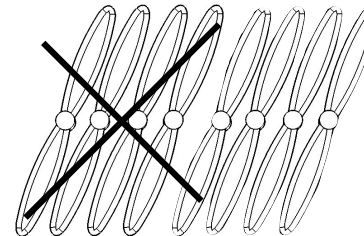

8 stk  
propeller CW/CCW

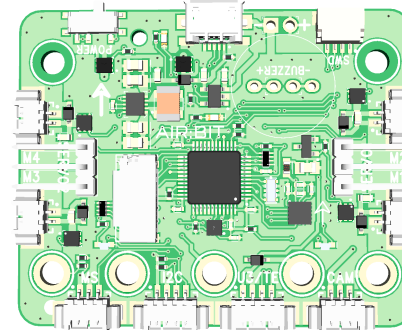

1 stk  
Styrekort



1 stk  
strikk

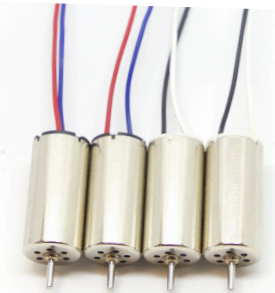

2 stk CW (rød/blå)  
2 stk CCW (hvit/sort)  
motorer



4 stk spiler

# Montering av fjernkontroll

Verktøy: Mellomstor stjernetrekker

## Deler:



2 stk

nylonskruer m3x8



2 stk

nylonmuttere m3

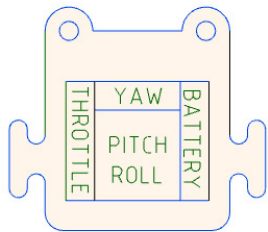

fjernkontroll-  
holder



1 stk

stor gummiring

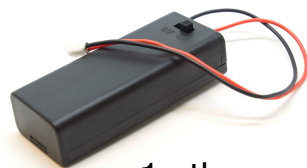

1 stk

batteriboks AAA (evt AA)

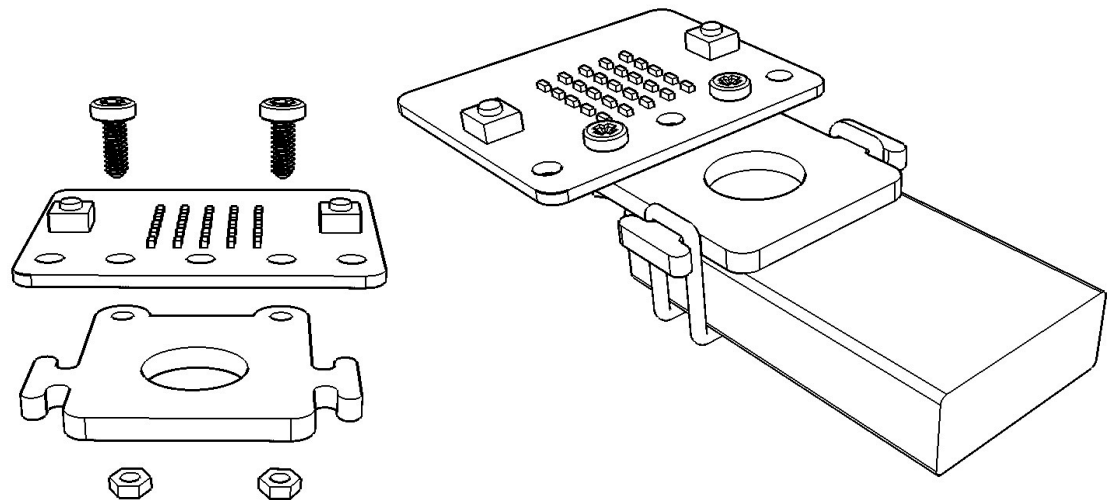

- Skru fast micro:bit til holderen med de lange skruene (1)
- Montér batteriboksen med gummiringen (2)
- Ulike batteribokser kan brukes

# Montering av ramme

Verktøy: Mellomstor stjernetrekker

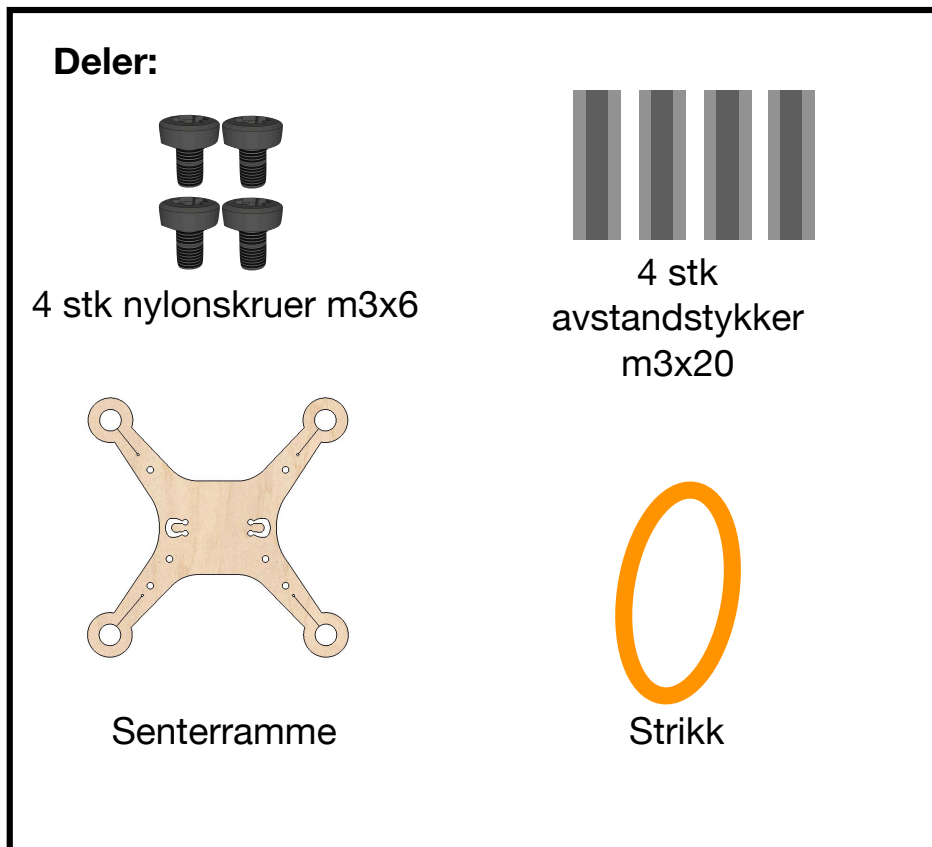

- Skru fast avstandstykkene med skruene som vist på bildene
- Montér strikken fra den høyre kroken, over platen, ned forbi den venstre kroken, under platen, tilbake til den høyre kroken
- Strikken vil da



# Montering av motorer

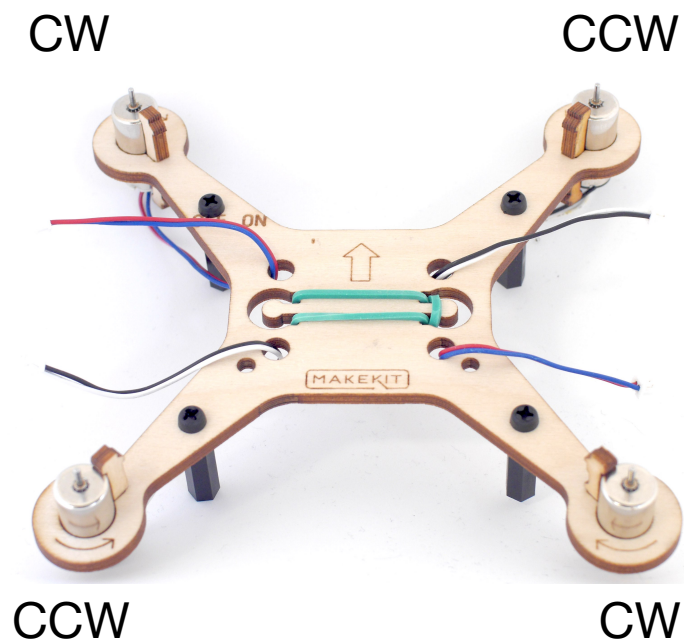
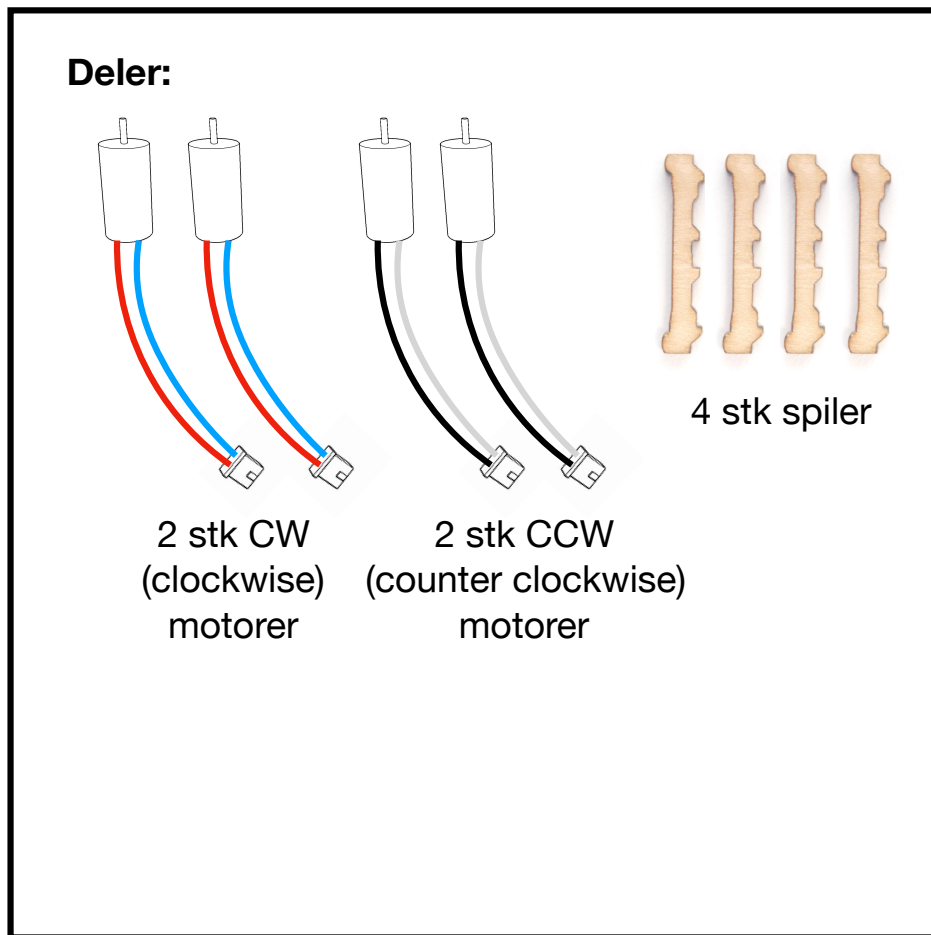

- Motorene (CW og CCW) skal plasseres slik bildet viser.
- Montér motorene på rammen med hver sin spile: Først settes spilen inn, deretter klikkes motoren på plass
- Trekk motorkablene opp gjennom hullene

# Micro:bit og tønne-muttere

Verktøy: Mellomstor stjernetrekker

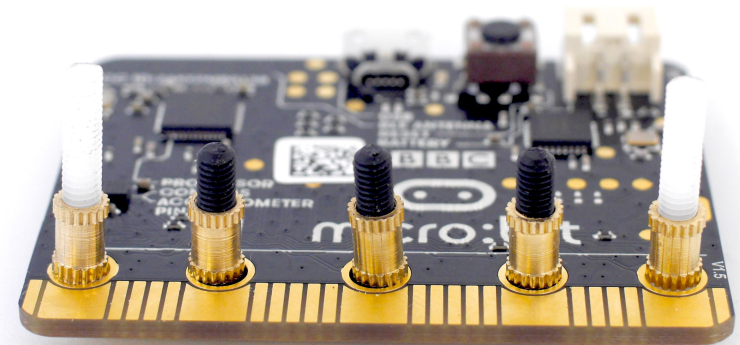
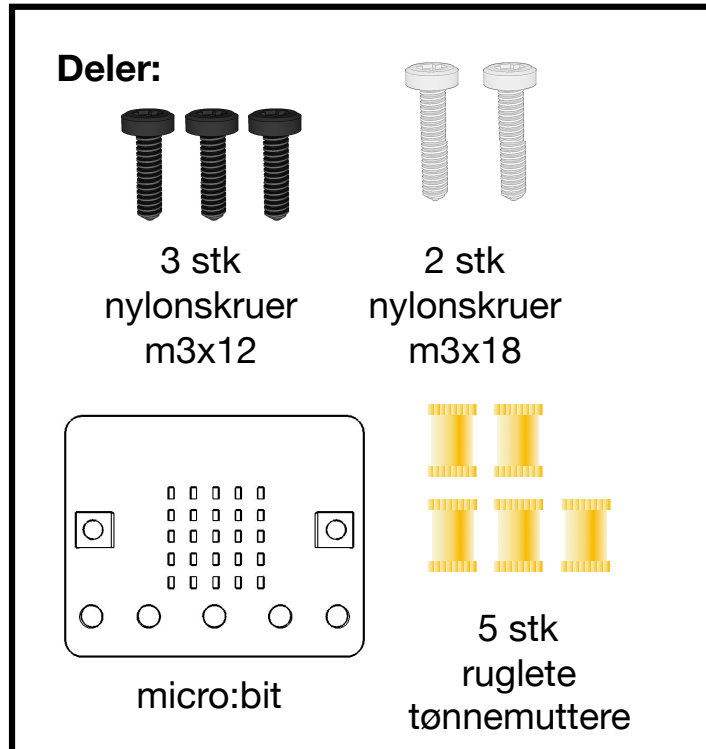

m3x18 - m3x12 - m3x18

- Skru fast tønne-mutterene med hhv. m3x18 og m3x12. De skal skrues passe hardt fast:
- Hardt nok til at det blir strømførende kontakt med micro:bit,
- Ikke så hardt at skruen eller micro:biten skades.

# Styrekort

**Verktøy:** Mellomstor stjernetrekker, pipenøkkel 5.5mm

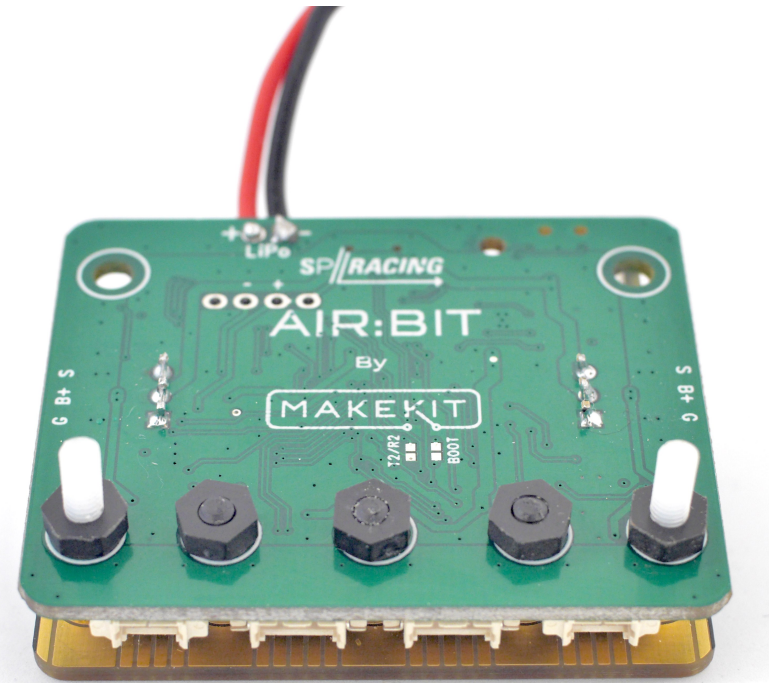
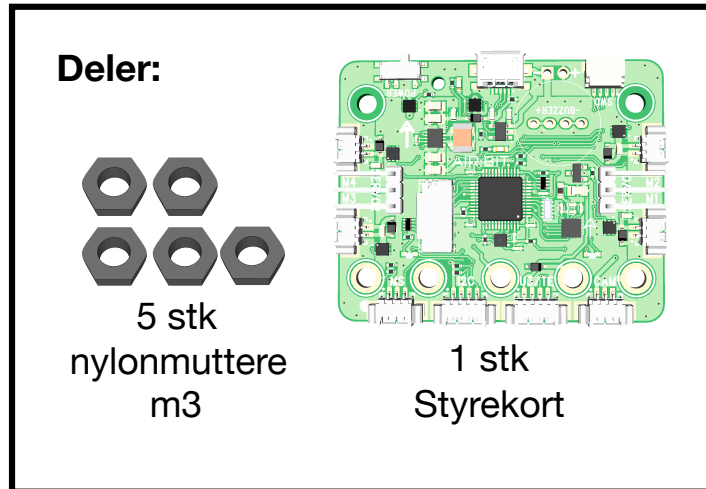

- Plasser styrekortet på skruene som vist på bildet.
- Skru fast en mutter på hver skru
- Hardt nok til at det blir strømførende kontakt
- Ikke så hardt at mutter eller styrekort skades.

# Montere styrekort og motorer

Verktøy: Pipenøkkel 5.5mm

Deler:



2 stk  
nylonmuttere  
m3

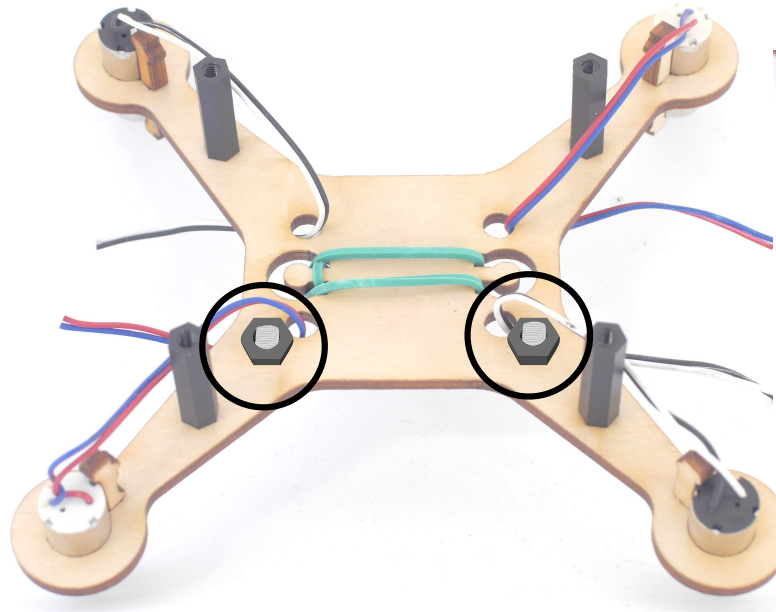

- Skru fast styrekort med to nylonmuttere på undersiden

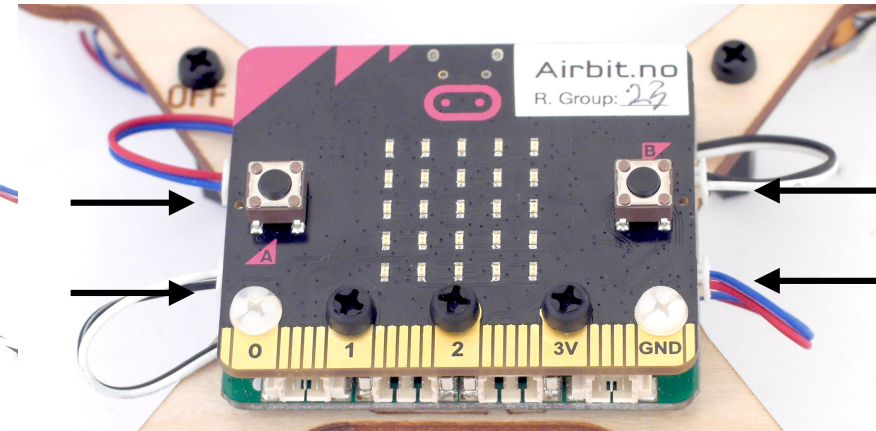

- Snu quadkopteret rett vei
- Plugg i de fire motorene på siden av kortet

# Batteri

Deler:



1 stk Lithium  
(LiPo)-batteri

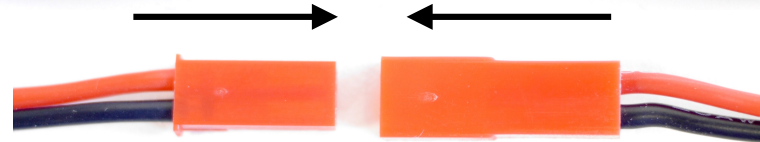
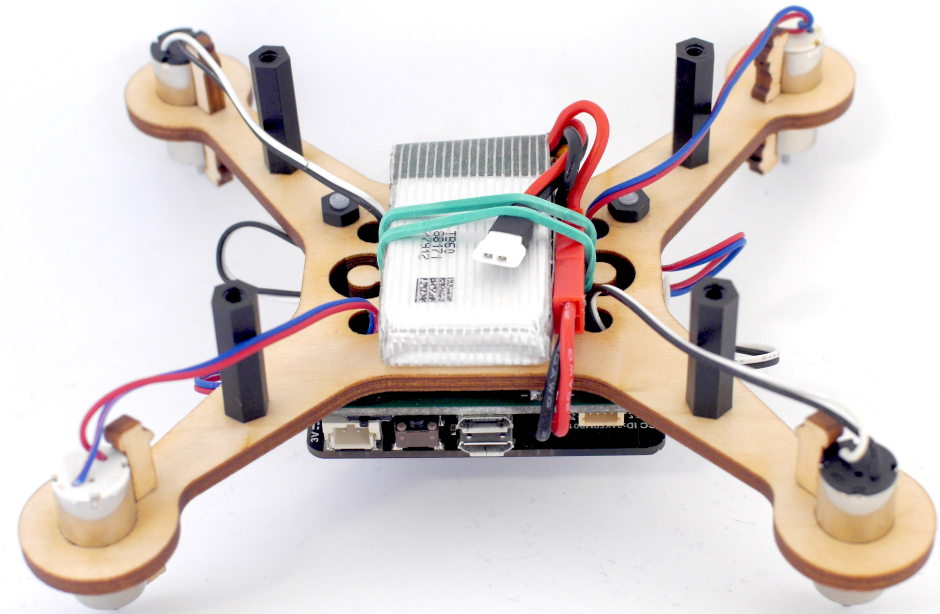

Rett



Feil



- Fest batteriet under stikken
- OBS! Rød kabel til rød kabel, sort til sort.



# Propeller

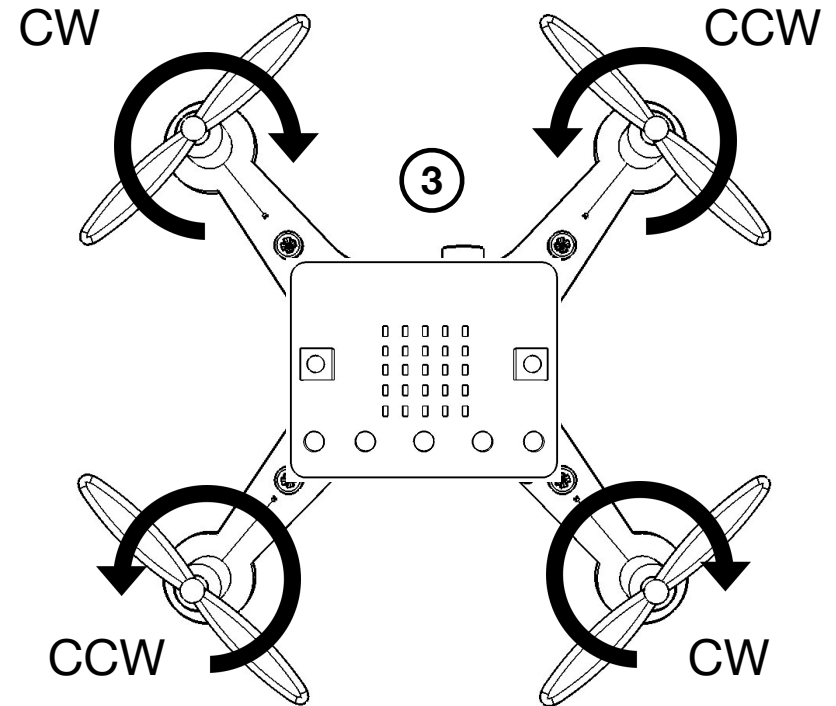
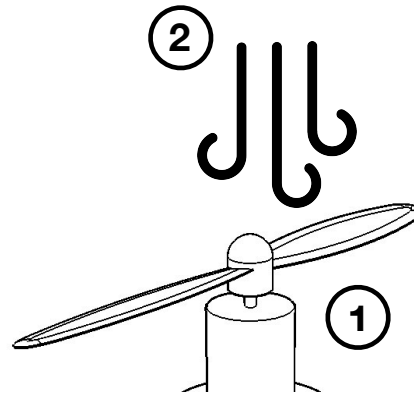
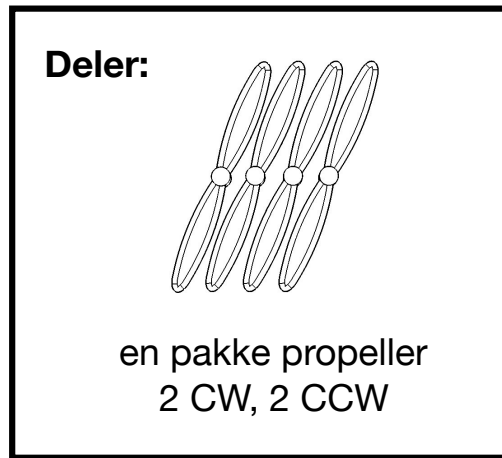

- Åpne en pakke propeller. Der finnes det 2 CW og 2 CCW propeller
- Finn fram den første propellen og plasser den på et bord eller på en motor (1)
- Blås nedover propellen (2)
- Om den roterer **med klokka**, er det en **CW** propell.
- Om den roterer **mot klokka**, er det en **CCW** propell.
- Plassér alle fire propellene korrekt i henhold til oversikten (3)

**Spørsmål? Ikke nøl med å kontakte oss!  
Bruk gjerne vår facebook-chat**



[www.makekit.no](http://www.makekit.no)



henning@makekit.no



makekit



gomakekit (også twitter)