

CVO FIRE 



RIBBON GAS FIRES

FIRE RIBBON®

CVO BRITISH MANUFACTURING: We are a UK gas fire manufacturing company with a range of products to meet every installation requirement. CVO fire has been at the forefront of gas fire design since 1999, using cutting edge technology to create unique, desirable gas fires. All of our **FIRE RIBBON™** gas fireplaces are handmade at our UK factory at Newton Aycliffe in the North East of England using locally sourced materials. Every gas fire is given a 40-point test at the factory to ensure that it performs exactly as designed ensuring a long and reliable service.

UNIQUE BURNER DESIGN: CVO Fire created the **FIRE RIBBON™** gas burner technology in 2003. We have supplied our ribbon fireplaces to properties in the UK, Europe, USA and Australia. We design our fires to have a beautiful flame with reliability and quality built in from the start. Our Fire Ribbon fireplaces can be found in hotels around the World being used for long periods of time for many months of the year. Our client list includes Companies such as Hilton, Crowne Plaza and Fairmont who demand high quality products for their properties. The **FIRE RIBBON™** was featured on the Channel 4 program Grand Designs.

CHOICE: Our range includes ribbon gas fires from 520mm wide to 1500mm wide, there are multiple design styles, installation styles and material options. Fires are available for use with either Natural Gas or LPG (Propane).

EASY INSTALLATION: Our **FIRE RIBBON™** gas fires have been designed to allow the most cost effective installation. All fires have a minimum depth requirement which will allow installation into both old and new properties. All of our designs can be used in a new build property with a flue liner and false chimney breast construction. There are versions of RIBBON, RIVER, ESSENCE, FR520 & FR850 that can be installed in a class 2 chimney or using only a 127mm flue liner and no requirement for an air vent in the room. None of our ribbon fires, when installed as instructed, will require a fan system or expensive flue routing. The only requirement is a flue system and gas supply.

THERMOSTATIC REMOTE: All of our ribbon gas fires are operated by a thermostatic remote control system which is powered by batteries. By selecting a desired room temperature on the hand set, the remote system will adjust the flame to maintain the room temperature. This creates a more comfortable environment and also helps to reduce energy bills. The handset also has a sleep timer should you wish to run the fire for a fixed period of time before switching off automatically.

CE CERTIFICATION: Our **FIRE RIBBON™** gas fires are tested to the latest CE approval standard. This approval includes tests for reliability, safety and function. The CE test standard is very strict and once awarded it allows us to manufacture our gas fires in the UK and then sell throughout Europe.

RIBBON BURNER TRAYS: For trade customers we have a wide range of Fire Ribbon burner trays available for use in custom made fireplace designs. To discuss bespoke fireplaces, call sales to discuss your requirements.

FIREVAULT SHOWROOM: We have a fireplace showroom within our factory with ribbon gas fires on live display. The showroom is open Monday to Saturday, 9am to 6pm.

TECHNICAL INFORMATION: We can supply all the technical information you require to decide the suitability of the product for your home prior to ordering. Most information is available from the technical section of the web site www.cvo.co.uk. We can also email install booklets, technical sheets and drawings.

PRICES & ORDERING: To get the latest prices and special offers call sales. Prices are also available online at our web store at www.cvo.co.uk. Sales are direct from our factory and selected distributors in the UK and across Europe. To discuss our gas fires in greater detail and to place your order call sales on **01325-301020**, Monday to Saturday, 9am to 6pm. For trade and volume customers call to set up a trade account.

CONTENTS:

Page 2 : **About CVO Fire**

Page 4 : **FIRE WAVE™** – 1500mm wide, trimless or with fascia trim.

Page 6 : **FIREBREAK** – 1600mm wide with stone fascia.

Page 8 : **STELA** – 1200mm wide trimless or with fascia trim.

Page 10 : **FIRE RIBBON™** – 1345mm wide with stone fascia.

Page 12 : **FIRE RIVER™** – 850mm wide, trimless or with fascia trim.

Page 14 : **BORDINO** – 817mm wide with stone shelf.

Page 16 : **COMPACT** – 978mm wide with stone fascia

Page 18 : **ESSENCE** – 657mm wide with metal fascia trim.

Page 20-23 : **BURNER TRAYS** – A selection of our burner trays.

Our range includes many styles of gas, bio-ethanol and wood burning fireplaces. Each product range has a separate brochure. If our fire ribbon designs are not suitable we have products for all installation requirements available. To discuss your requirements in detail call sales on **01325-301020**, Monday to Saturday.



“ Their award winning designs look amazing ”

The Telegraph.





Fire Wave[®]

DESCRIPTION

The FIRE WAVE™ widescreen gas fireplace has a stunning ribbon of flame and overall width of 1500mm. This modern gas fire has been designed to allow installation into the majority of properties and only requires a class 1 chimney or 178mm flue liner to operate. Supplied to site as a complete package installation is easy requiring only a gas supply and flue connection.

There are six enclosure styles available with different opening sizes, either 265mm or 1745mm high, and either black, brushed or polished steel finishes. This fire has an attractive “letterbox” look that can be installed “frameless” or with a trim from a choice of metal and natural stone finishes. The fire can be used with either a clean ribbon of flame or add logs or pebbles.

The FIRE WAVE™ has a 10.7Kw power rating and is operated by a thermostatic remote control which can be used to control the room temperature to a desired level by automatically adjusting the flame. This fire has been installed in many homes, hotels and restaurants around the World, typically with a TV above to create a stunning wall feature.

SPECIAL FEATURES

- 1500mm wide, 10.7Kw Landscape Fireplace.
- Minimum Chimney and Depth Requirement.
- Supplied as a Complete Package for Easy Install.
- Thermostatic Remote Control

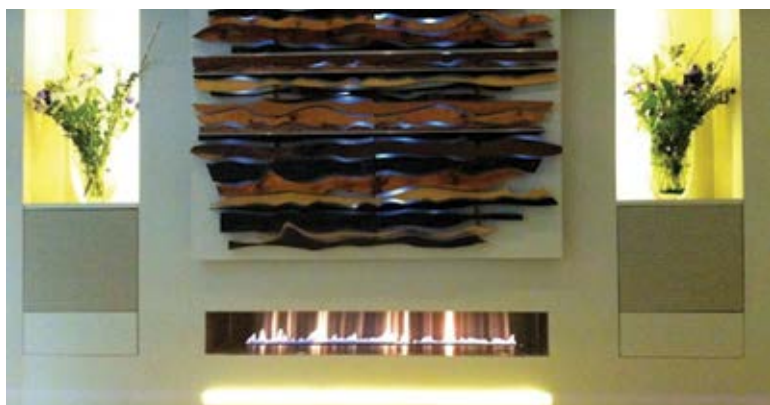

TECHNICAL DATA

Model	FIREWAVE (175)	FIREWAVE (265)
Power (kw)	10.7	
Chimney	Class 1	
Flue Size (mm)	178	
Min Length (m)	2.5	
Opening (mm)	1500 x 175	1500 x 265
Air Vent	Yes	Yes
Gas Types	Natural Gas or LPG/Calor	
Ignition	Thermostatic Remote	
Power	Battery	
Approval	CE-EN509	
Installation	Europe Wide	
Ceramics	Clean Flame, Logs or Pebbles	
Enclosure	Black, Brushed or Polished	
Trim	No Trim, Black, Brushed or Stone	
Design	Single or Double Sided	

NOTE: The (265) version has a small glass panel at the top of the enclosure.

FRONT ONLY

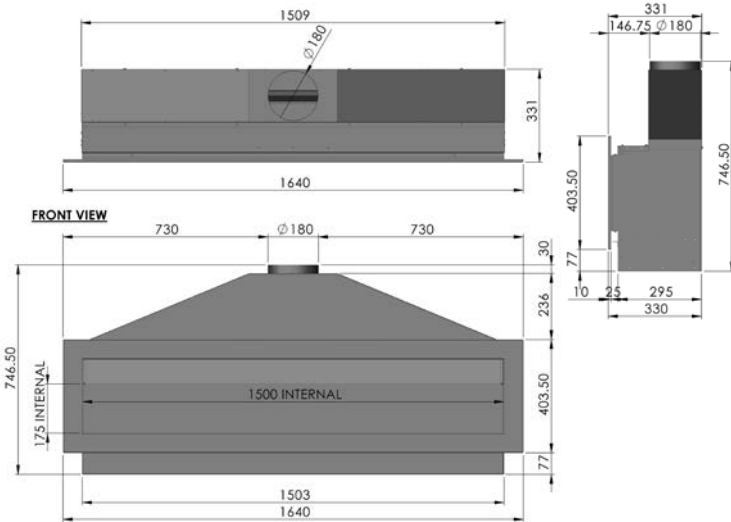

DOUBLE SIDED

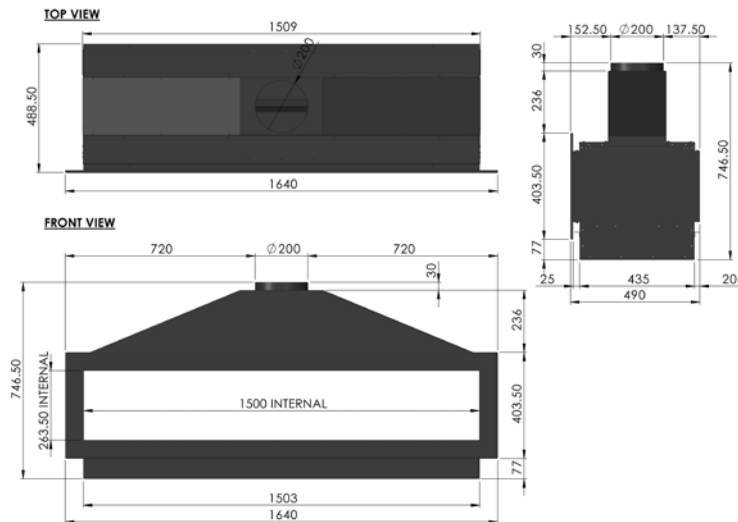



Firebreak

DESCRIPTION

The FIRE BREAK 1600mm Wide Ribbon Gas Fire is a truly glamorous Hole in the Wall gas fireplace with a 1100mm wide enclosure, 1500mm wide floating hearth and our stunning ribbon burner. The fire is supplied with a steel fire box and gather to make installation easy and a full natural stone enclosure in either Limestone or Black Granite. This is a large and impressive fireplace built to a very high standard. A polished bronze version is available upon request.

This modern, CE approved, ribbon gas fire, is operated by an RF remote system with a handset. The remote is programmable and includes a thermostat to control room temperature.

The Fire Break is available for use with either Natural Gas or LPG/Propane and can be installed in the UK, Ireland and all other European Countries. The Fire Break has been designed to be installed in most properties.

SPECIAL FEATURES

- Many Styles and Finishes Available
- Minimum Chimney and Depth Requirements
- Large Flame
- Thermostatic Remote Control



TECHNICAL DATA

Model	FIREBREAK
Power (kw)	10
Chimney	Class 1
Flue Size (mm)	178
Min Length (m)	3
Opening (mm)	1200 x 265
Air Vent	100cm ² Free Air Required
Gas Types	Natural Gas or LPG/Calor
Ignition	Thermostatic Remote
Power	Battery
Approval	CE-EN509
Installation	Europe Wide
Ceramics	Clean Flame, Logs or Pebbles
Enclosure	Black / Limestone or Bronze
Trim	Black / Limestone or Bronze
Design	Single Sided

DRAWING 1

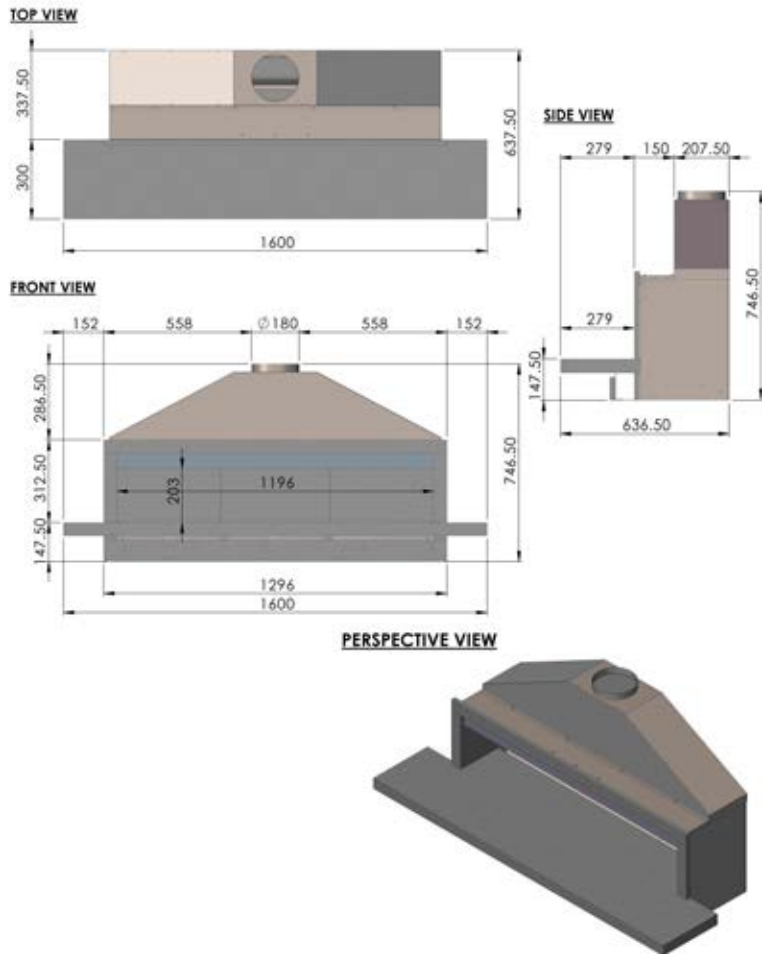

DRAWING 2

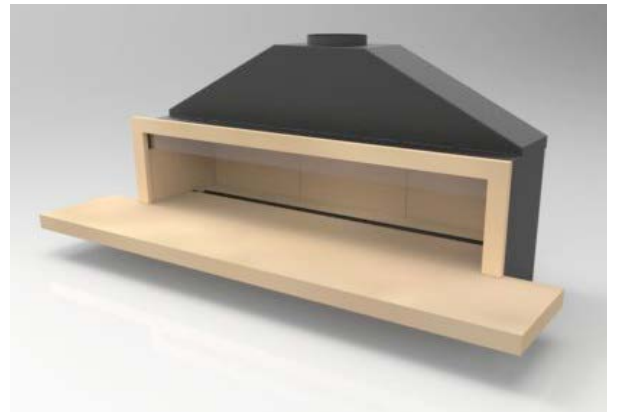
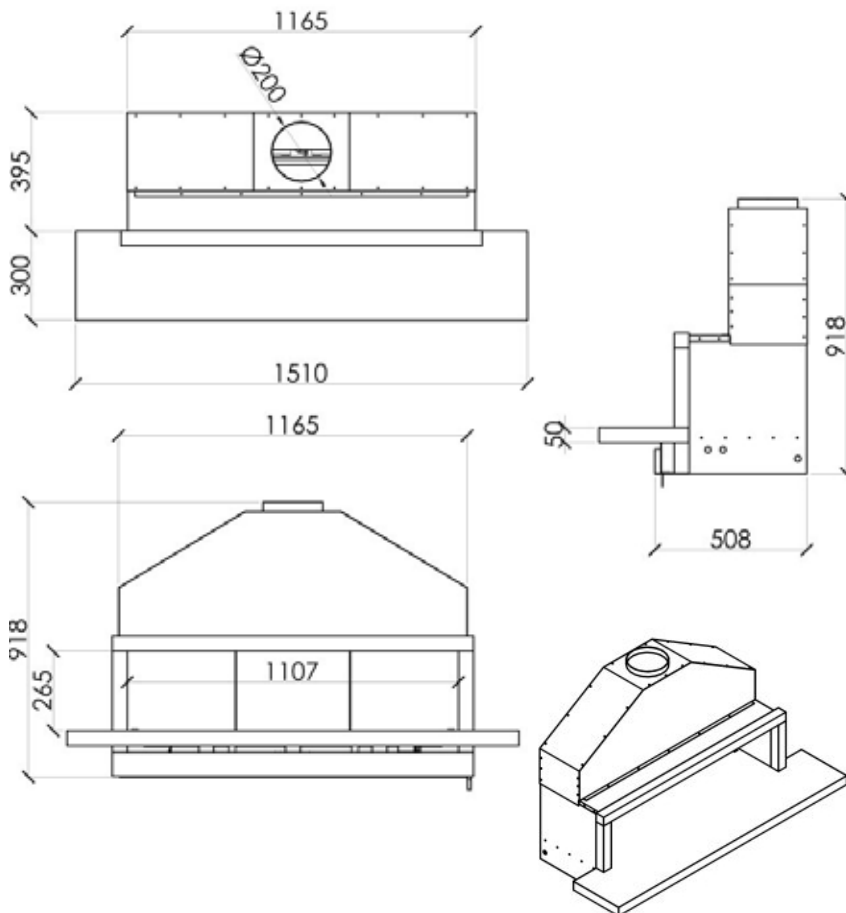



Stela

DESCRIPTION

The STELA 1200mm Wide is part of our ribbon gas fire range. This 10Kw gas burner has a dancing ribbon of flame and a wide range of enclosure options – with or without a trim. The STELA ribbon gas fire has minimal depth (320mm) and is available with either brushed stainless, black, polished or natural stone interior. There is an option to add either logs or pebbles if desired.

This modern, CE approved, ribbon gas fire, is operated by an RF remote system with a handset. The remote is programmable and includes a thermostat to control room temperature.

The STELA is available for use with either Natural Gas or LPG/Propane and can be installed in the UK, Ireland and all other European Countries. The fireplace is supplied as a complete package including a gather unit with a 180mm spigot. The STELA has been designed to be installed in most properties.

SPECIAL FEATURES

- Many Styles and Finishes Available
- Minimum Chimney and Depth Requirements
- Thermostatic Remote Control



TECHNICAL DATA

Model	STELA
Power (kw)	10
Chimney	Class 1
Flue Size (mm)	175
Min Length (m)	3
Opening (mm)	1200 x 265
Air Vent	100cm ² Free Air Required
Gas Types	Natural Gas or LPG/Calor
Ignition	Thermostatic Remote
Power	Battery
Approval	CE-EN509
Installation	Europe Wide
Ceramics	Clean Flame, Logs or Pebbles
Enclosure	Black, Brushed or Polished
Trim	Black / Brushed Steel or Stone
Design	Single or Double Sided

FRONT ONLY

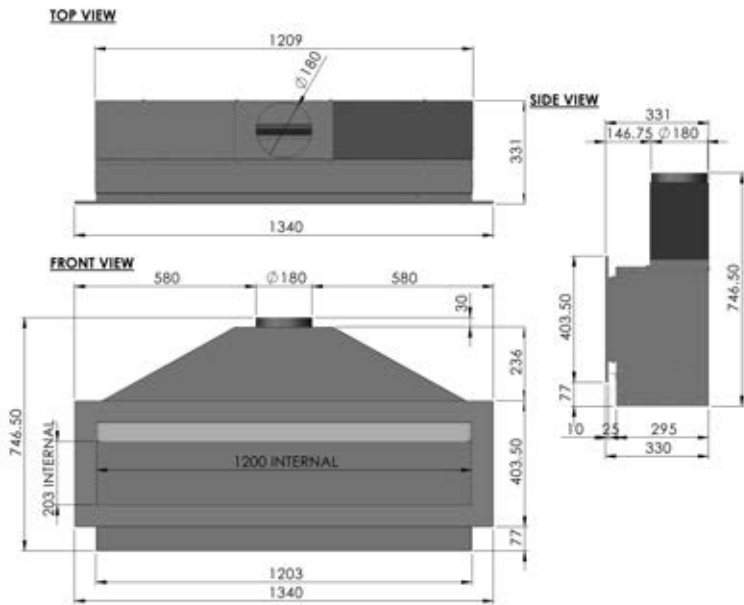

DOUBLE SIDED

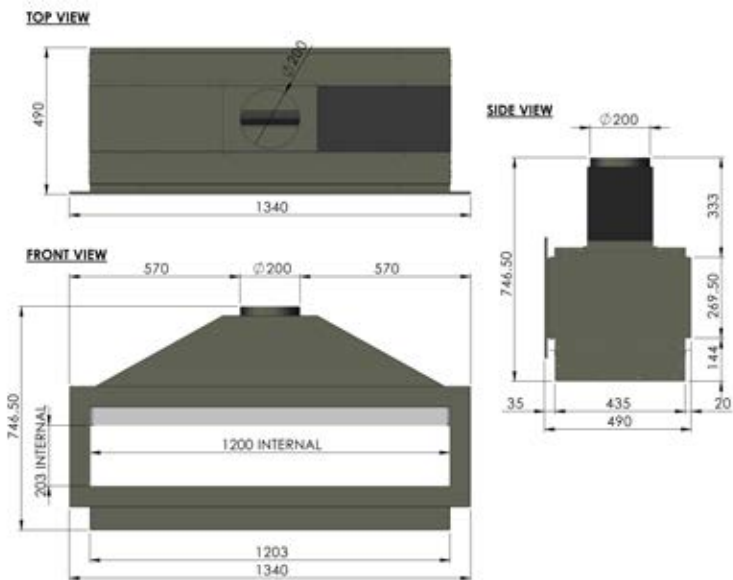



Fire Ribbon[®] with Stone Fascia

DESCRIPTION

The FIRE RIBBON™ is an example of exquisite, contemporary design featuring our trademark fire ribbon gas burner technology with a large dramatic flame. The Fire Ribbon features a beautiful natural stone fascia which is 1345mm wide. There are over 20 different stone types to choose from and along with a choice of polished, brushed or black enclosure it is possible to create a unique design feature within the room.

The fire has been designed to allow installation into most old and new properties with a wide range of chimney options and minimal depth required. When choosing the special NV version of the gas fire only a class 2 or 127mm flue liner is required and there is no need for any air ventilation into the room. Choose from either single sided or double sided versions.

With a 7.4Kw remote control gas burner operated by a thermostatic remote control it is possible to set the room temperature on the hand set and the fire will adjust the flame to maintain the room temperature at a comfortable level. This helps to reduce energy bills.

SPECIAL FEATURES

- Beautiful Natural Stone Fascia
- Minimum Chimney and Depth Requirements
- No Air Vent Required (NV Version)
- Thermostatic Remote Control



TECHNICAL DATA

Model	RIBBON (NV)	RIBBON
Power (kw)	7.4	7.4
Chimney	Class 2	Class 1
Flue Size (mm)	127	178
Min Length (m)	3	2
Opening (mm)	850 x 265	
Air Vent	No	Yes
Gas Types	Natural Gas or LPG/Calor	
Ignition	Thermostatic Remote	
Power	Battery	
Approval	CE-EN509	
Installation	Europe Wide	
Ceramics	Clean Flame, Logs or Pebbles	
Enclosure	Black, Brushed or Polished	
Trim	Various Natural Stone	
Design	Single or Double Sided	

NOTE: The (NV) version has a small glass panel at the top of the enclosure to allow the fire to be fitted without an air vent.

FRONT ONLY

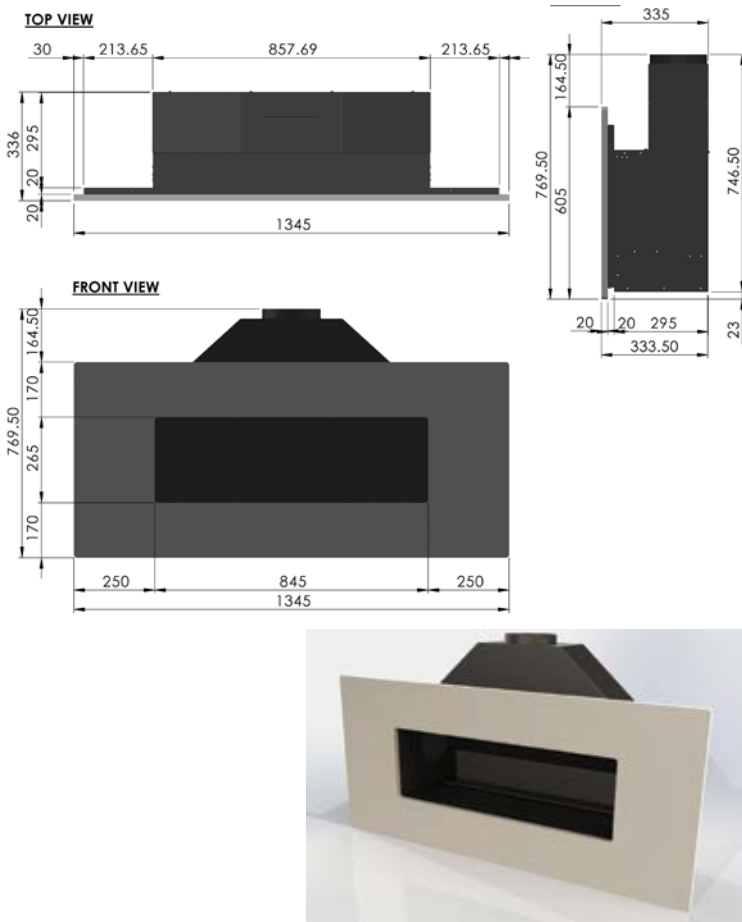

DOUBLE SIDED

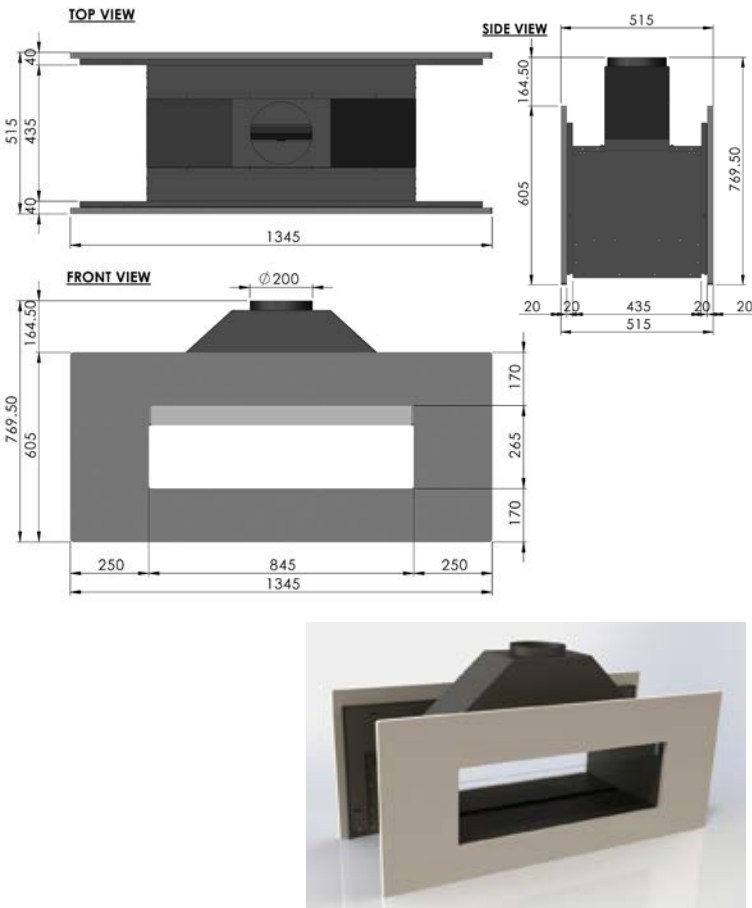



Fire River®

DESCRIPTION

The FIRE RIVER™ gas fire has been designed to allow installation into the majority of old and new properties with either a chimney or a flue liner. The Fire River uses a 7.4kw gas burner which showcases a beautiful, dancing, ribbon of flame. The standard fire has been designed with a trimless opening size of 850mm x 265mm creating a sleek letterbox style feature fireplace. When purchasing the NV version of the fire it can be installed using a class 2 chimney or larger and there is no requirement for an air vent in to the room.

Choose from many design styles and finishes, enclosures are available in black, brushed or polished steel, trims can be supplied in either black, brushed or natural stone and the burner can either be operated with a clean ribbon of flame or the addition of fireplace logs or pebbles.

The fire is operated by a thermostatic remote control that can be used to control the room temperature this increases the fuel efficiency helping to reduce energy bills.

SPECIAL FEATURES

- Many Styles and Finishes Available
- Minimum Chimney and Depth Requirements
- No Air Vent (NV Version)
- Thermostatic Remote Control

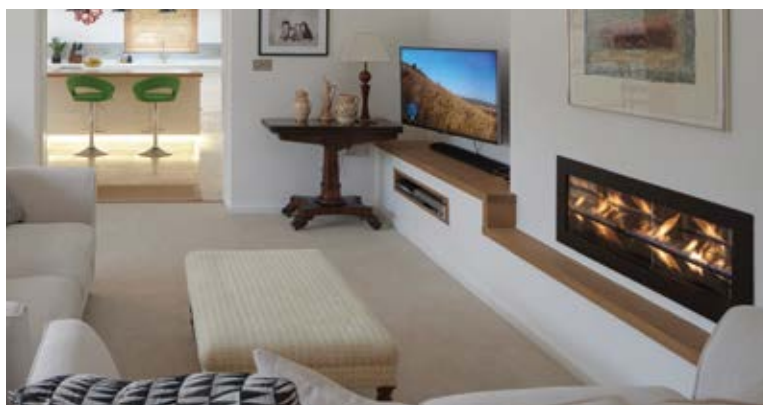

TECHNICAL DATA

Model	RIVER (NV)	RIVER
Power (kw)	7.4	7.4
Chimney	Class 2	Class 1
Flue Size (mm)	127	178
Min Length (m)	3	2
Opening (mm)	850 x 265	
Air Vent	No	Yes
Gas Types	Natural Gas or LPG/Calor	
Ignition	Thermostatic Remote	
Power	Battery	
Approval	CE-EN509	
Installation	Europe Wide	
Ceramics	Clean Flame, Logs or Pebbles	
Enclosure	Black, Brushed or Polished	
Trim	No Trim, Black, Brushed or Stone	
Design	Single or Double Sided	

NOTE: The (NV) version has a small glass panel at the top of the enclosure to allow the fire to be fitted without an air vent.

FRONT ONLY

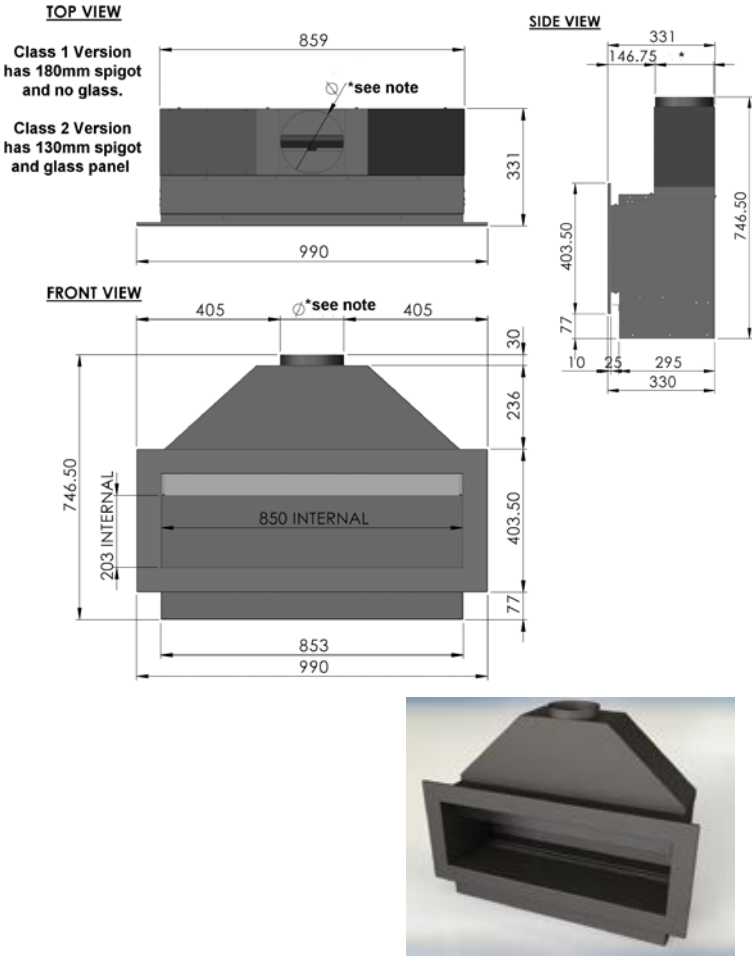

DOUBLE SIDED

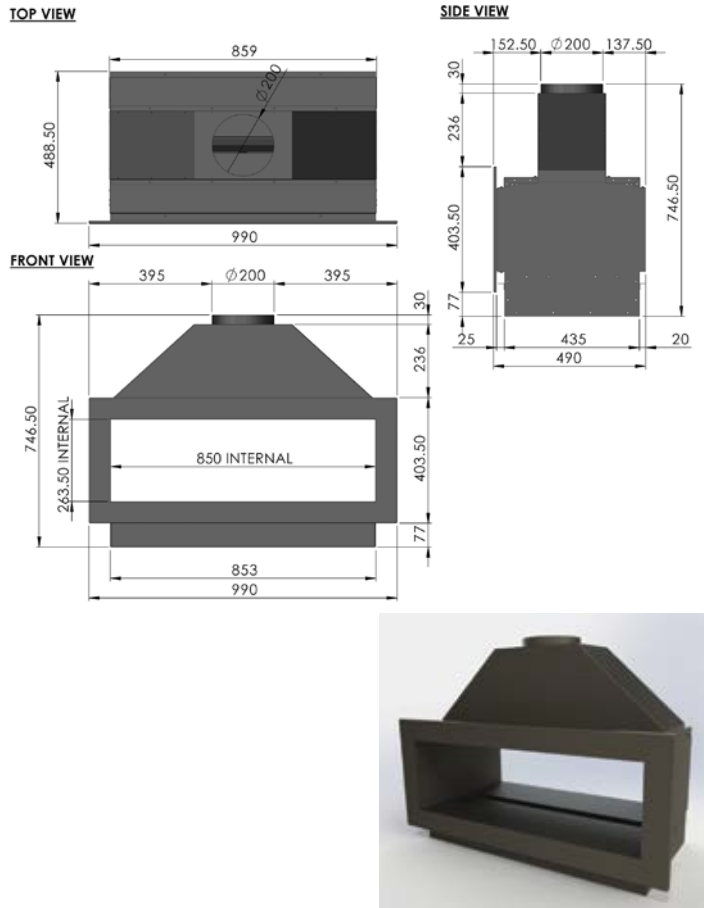



Bordino

DESCRIPTION

The BORDINO “Hole-in-the-Wall” gas fireplace with a floating shelf features our dancing flame ribbon gas burner. The 5.7Kw gas fire is designed with minimum depth of only 318mm allowing installation into most properties. The fire does not need an air vent in the room and can be used with any chimney or flue liner system.

To ensure easy installation the fire is supplied as a package with gas burner, remote control, steel enclosure, stone lining. There is also an optional gather.

Unique Technology - This fire is operated by a thermostatic remote control built into the handset. The digital handset can be set to the desired room temperature. Once set the handset will monitor the room temperature and adjust the flame up or down to keep the room at a steady temperature. this saves money and reduces energy use and gas bills.

SPECIAL FEATURES

- Easy Installation
- Minimum Chimney and Depth Requirements
- No Air Vent
- Thermostatic Remote Control



TECHNICAL DATA

Model	BORDINO
Power (kw)	5.7
Chimney	Class 1 / 2
Flue Size (mm)	178
Min Length (m)	3
Opening (mm)	512 x 265
Air Vent	100cm2 Free Air Required
Gas Types	Natural Gas
Ignition	Thermostatic Remote
Power	Battery
Approval	CE-EN509
Installation	Europe Wide
Ceramics	Clean Flame
Enclosure	Various Natural Stone
Trim	Various Natural Stone
Design	Single Sided

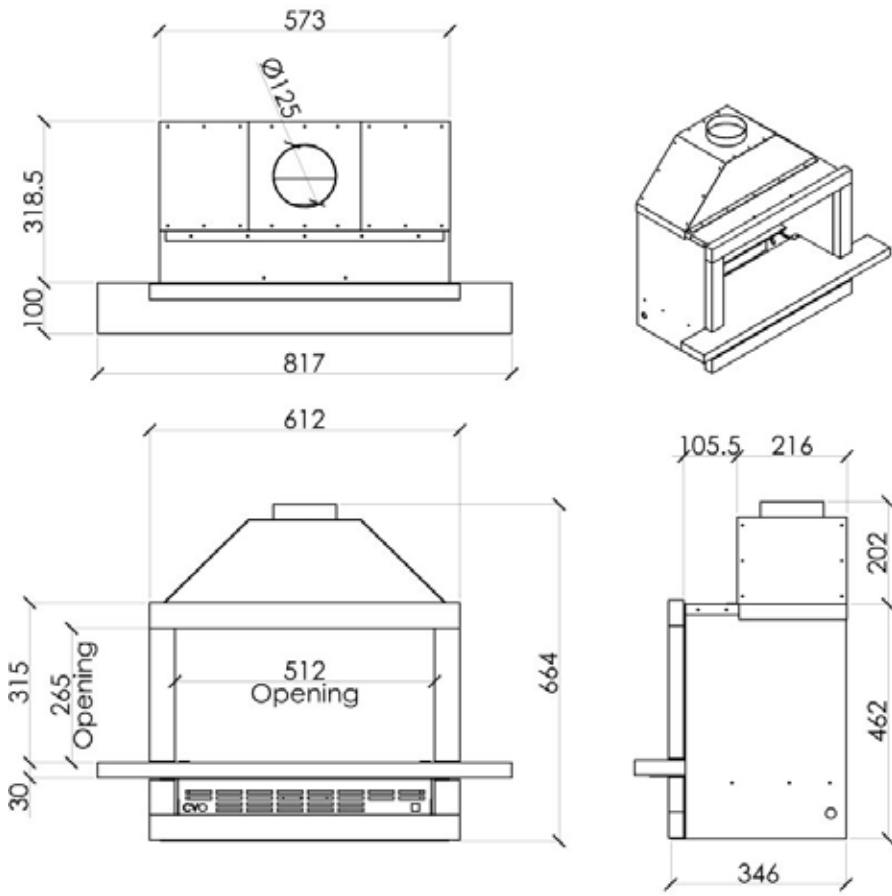



Compact Fire Ribbon

DESCRIPTION

The COMPACT FIRE RIBBON 520mm WIDE GAS FIRE is a smaller version of our popular Fire Ribbon with the same mesmerising and dramatic dancing ribbon of flame. The gas fire is supplied as a complete fireplace package including gas ribbon burner, enclosure, remote control and natural stone fascia. The fascia is available in a wide range of stone types.

The 5.7Kw gas burner is operated by a thermostatic remote control with digital handset. The fire is designed with minimal depth, 317mm, to allow installation into most properties. The fire requires only a gas supply and can be used with any chimney or flue liner system. No air vent is required with this modern contemporary fireplace design.

Unique Technology - Thermostatic Remote Control : This fire is operated by a thermostatic remote control built into the handset. The digital handset can be set to the desired room temperature. Once set the handset will monitor the room temperature and adjust the flame up or down to keep the room at a steady temperature. this saves money and reduces energy use and gas bills.

SPECIAL FEATURES

- Many Styles and Finishes Available
- Minimum Chimney and Depth Requirements
- Thermostatic Remote Control

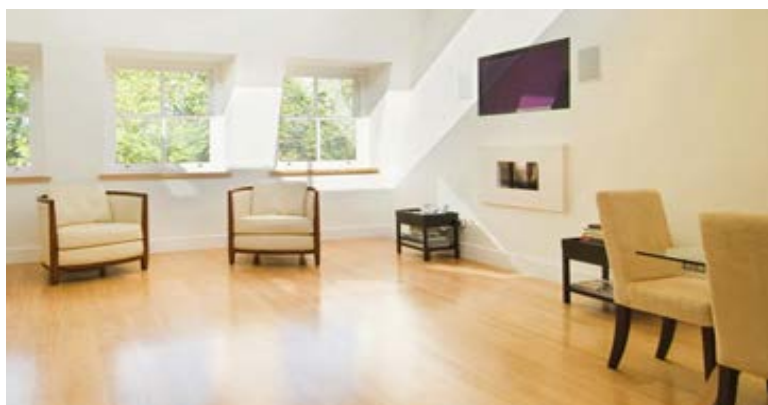

TECHNICAL DATA

Model	COMPACT RIBBON
Power (kw)	5.7
Chimney	Class 1 / 2
Flue Size (mm)	178
Min Length (m)	3
Opening (mm)	517 X 220
Air Vent	100cm2 Free Air Required
Gas Types	Natural Gas
Ignition	Thermostatic Remote
Power	Battery
Approval	CE-EN509
Installation	Europe Wide
Ceramics	Clean Flame
Enclosure	Various Natural Stone
Trim	Various Natural Stone
Design	Single Sided

FRONT ONLY

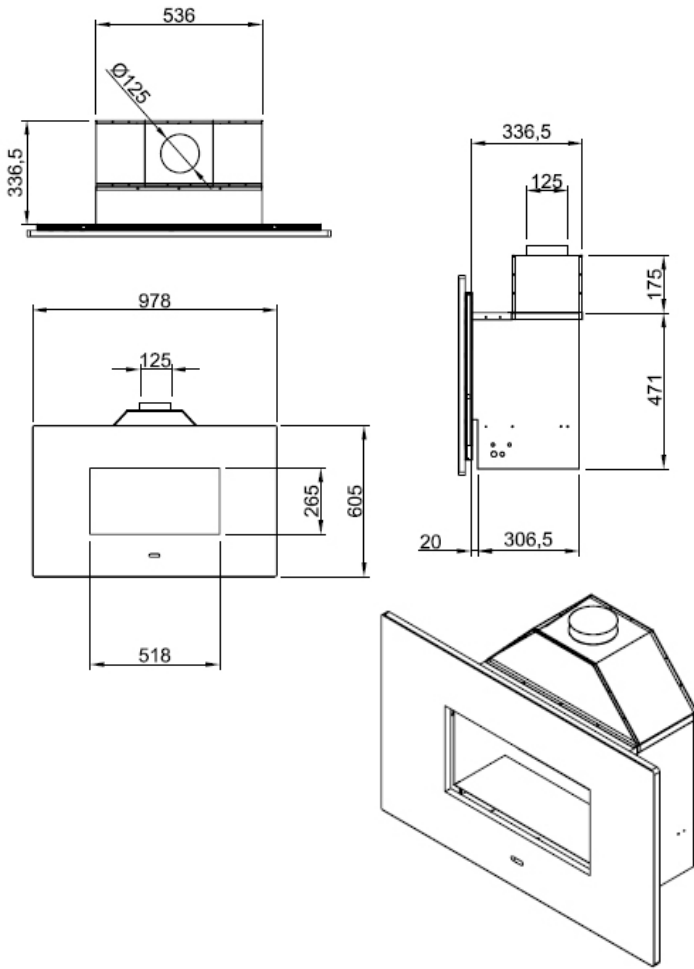

DOUBLE SIDED

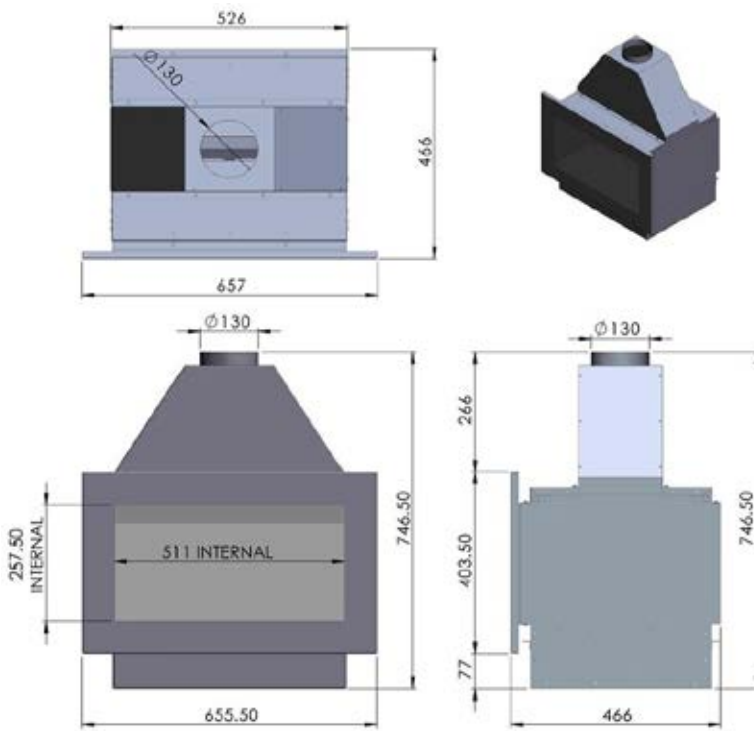



Essence

DESCRIPTION

The ESSENCE has been designed for rooms where a smaller feature fireplace is required. Using our trademark fire ribbon gas burner technology this petite fire has the same dancing flame effect as our other ribbon fires.

The fire is supplied with either a black or brushed steel trim and an enclosure in black steel with stainless shelves. This creates a stunning flame effect with multiple reflections. The standard fire has a clean ribbon of flame however logs or pebbles can be added if desired.

With an opening size of 517mm x 265mm and a 5.7Kw gas burner the essence can be used with most existing chimneys or a 127mm flue liner. There is no requirement for an air vent into the room. The fire is operated by thermostatic remote control that can be set to a desired room temperature to control the flame. It also has a sleep timer amongst other useful functions. This increases efficiency and usability of this petite fireplace and helps to reduce energy bills.

SPECIAL FEATURES

- Small Size, 5.7Kw, No Air Vent Required.
- Minimal Depth and Chimney Requirement.
- Thermostatic Remote Control.
- Tested to the Latest CE Approval.



TECHNICAL DATA

Model	ESSENCE
Power (kw)	5.7
Chimney	Class 1
Flue Size (mm)	127
Min Length (m)	3
Opening (mm)	517 x 265
Air Vent	No
Gas Types	Natural Gas
Ignition	Thermostatic Remote
Power	Battery
Approval	CE-EN509
Installation	Europe Wide
Ceramics	Clean Flame, Logs or Pebbles
Enclosure	Black, Brushed or Polished
Trim	Black or Brushed Steel
Design	Single or Double Sided

NOTE: The essence has a small glass panel at the top of the enclosure.

FRONT ONLY

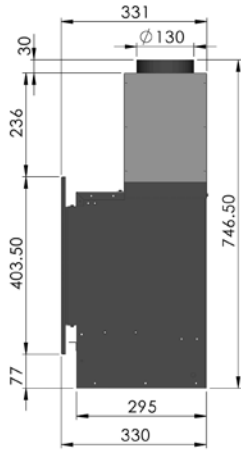
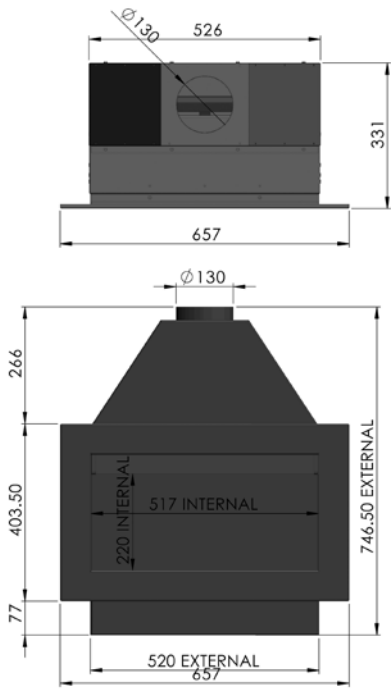

DOUBLE SIDED

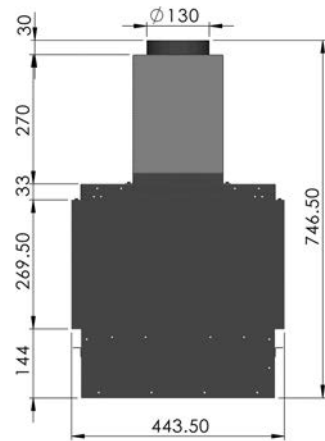
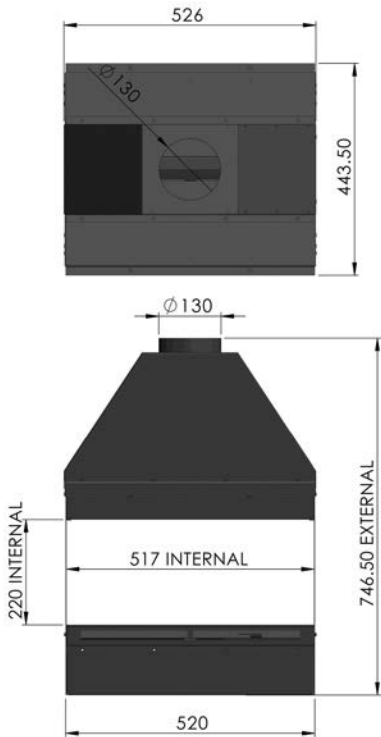

BB520

MAIN FEATURES

The BB520 is 520mm wide with a 5.7Kw Fire Ribbon burner operated by a battery powered thermostatic remote control with burners are available for Natural Gas. The burner tray is available in various styles and finishes. The standard model has a clean ribbon of flame however fireplace log or pebbles can be added if desired. Choose from either Single or Double Sided burners with either metal or stone shelves. Each burner type has a standard canopy which is available as an optional extra. (Read Technical Specification Sheet before Ordering).

VERSIONS

- BB520-S : Single Sided with Brushed or Black Stainless Steel.
- BB520-DS : Double Sided with Brushed or Black Stainless Steel.
- BB520-S-ST : Single Sided with either Limestone or Black Granite.
- BB520-DS-ST : Double Sided with either Limestone or Black Granite.

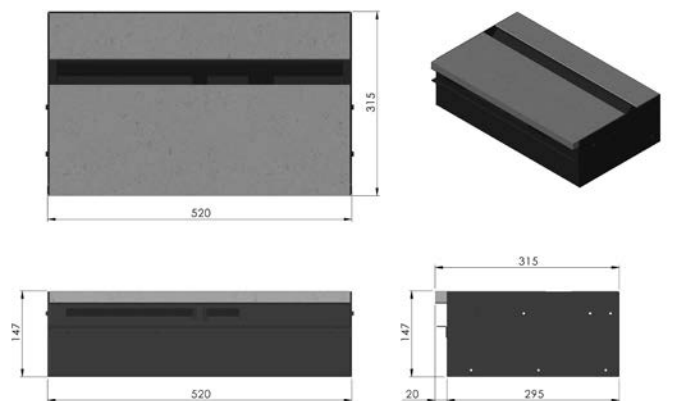
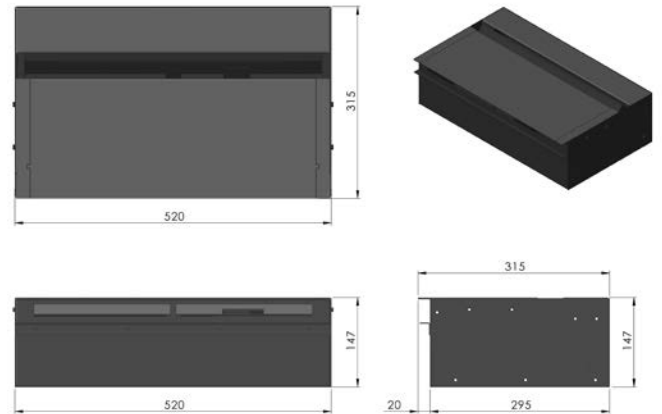

BB850

MAIN FEATURES

The BB850 is 850mm wide with a 7.4Kw Fire Ribbon burner operated by a battery powered thermostatic remote control with burners are available for either Natural Gas or LPG/Propane. The burner tray is available in various styles and finishes. The standard model has a clean ribbon of flame however fireplace log or pebbles can be added if desired. Choose from either Single or Double Sided burners with either metal or stone shelves. Each burner type has a standard canopy which is available as an optional extra. (Read Technical Specification Sheet before Ordering).

VERSIONS

- BB850-S : Single Sided with Brushed, Polished or Black Stainless Steel.
- BB850-DS : Double Sided with Brushed, Polished or Black Stainless Steel.
- BB850-S-ST : Single Sided with either Limestone or Black Granite.
- BB850-DS-ST : Double Sided with either Limestone or Black Granite.

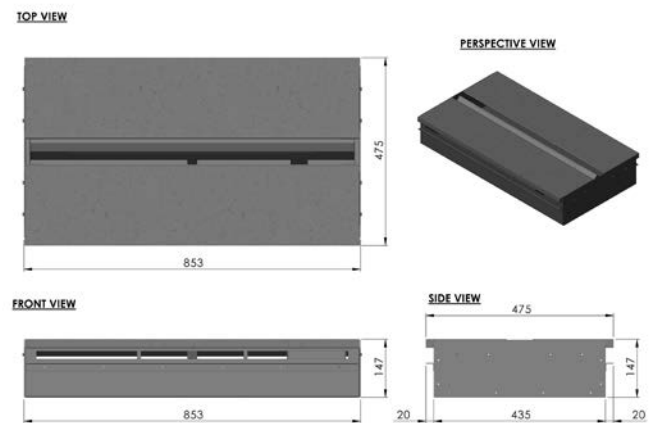
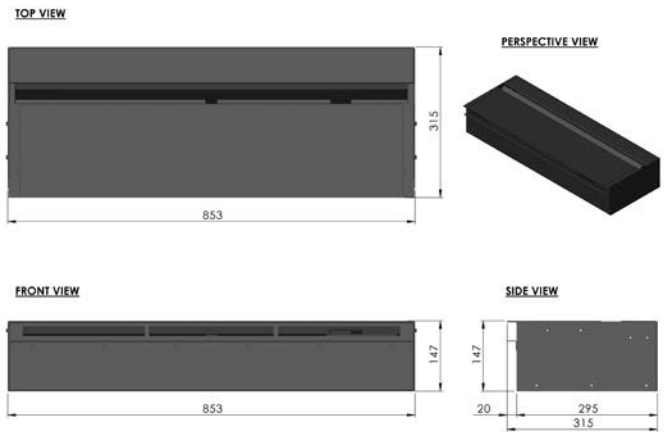

BB1200

MAIN FEATURES

The BB1200 is 1200mm wide with a 10.0Kw Fire Ribbon burner operated by a battery powered thermostatic remote control with burners are available for either Natural Gas or LPG/Propane. The burner tray is available in various styles and finishes. The standard model has a clean ribbon of flame however fireplace log or pebbles can be added if desired. Choose from either Single or Double Sided burners with either metal or stone shelves. Each burner type has a standard canopy which is available as an optional extra. (Read Technical Specification Sheet before Ordering).

VERSIONS

- BB1200-S : Single Sided with Brushed, Polished or Black Stainless Steel.
- BB1200-DS : Double Sided with Brushed, Polished or Black Stainless Steel.
- BB1200-S-ST : Single Sided with either Limestone or Black Granite.
- BB1200-DS-ST : Double Sided with either Limestone or Black Granite.



TOP VIEW



PERSPECTIVE VIEW

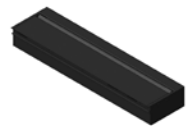

FRONT VIEW



SIDE VIEW

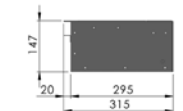

TOP VIEW

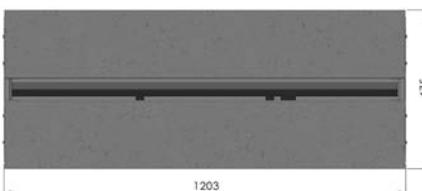

PERSPECTIVE VIEW



FRONT VIEW



SIDE VIEW



BB1500

MAIN FEATURES

The BB1500 is 1500mm wide with a 10.7Kw Fire Ribbon burner operated by a battery powered thermostatic remote control with burners are available for either Natural Gas or LPG/Propane. The burner tray is available in various styles and finishes. The standard model has a clean ribbon of flame however fireplace log or pebbles can be added if desired. Choose from either Single or Double Sided burners with either metal or stone shelves. Each burner type has a standard canopy which is available as an optional extra. (Read Technical Specification Sheet before Ordering).

VERSIONS

- BB1500-S : Single Sided with Brushed, Polished or Black Stainless Steel.
- BB1500-DS : Double Sided with Brushed, Polished or Black Stainless Steel.
- BB1500-S-ST : Single Sided with either Limestone or Black Granite.
- BB1500-DS-ST : Double Sided with either Limestone or Black Granite.

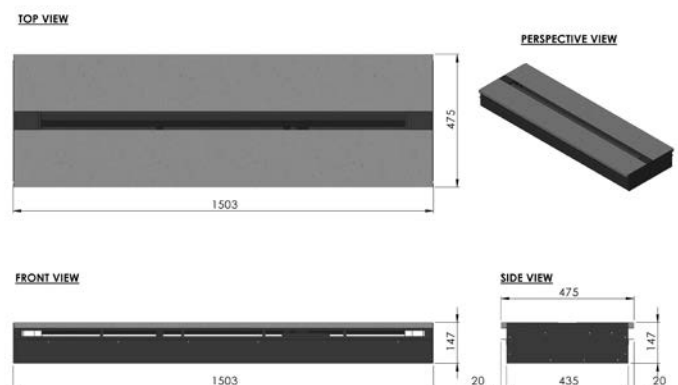
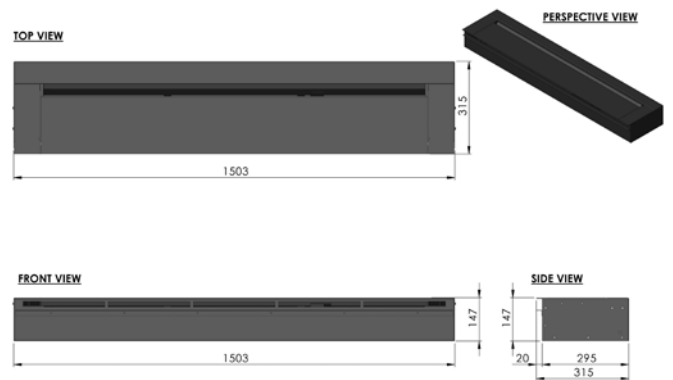

CVO FIRE

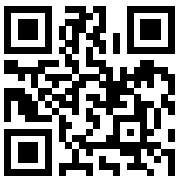

For additional details, technical specifications and prices call
Sales: Monday to Saturday, 9am to 6pm
or email: sales@cvo.co.uk

CVO FIRE is a brand of Spirit Fires Limited
4 Beaumont Square, Aycliffe Industrial Park
Newton Aycliffe, Co. Durham DL5 6XN

Call: 01325 301020
Email: sales@cvo.co.uk
Web: www.cvo.co.uk

 /CVOFIRE

 @cvo_fires

Class 1 Ribbon Gas Fires



RETAIL PRICE LIST

SKU	Product Name	RRP (inc VAT)
X-SFR-01	Convert Fire River/Ribbon to Class 2 (No Air Vent) - NATURAL GAS ONLY	69.99
X-DFR-04	Double Sided Fire Ribbon - Polished Steel Enclosure & 2x 4pc Black Granite Fascia (with Gather) - Natural Gas	3,699.00
X-DFR-03	Double Sided Fire Ribbon - Polished Steel Enclosure & 2x 4pc Limestone Fascia (with Gather) - Natural Gas	3,499.00
X-DFR-02	Double Sided Fire Ribbon - Polished Steel Enclosure & 2x 4pc Madre Perle Fascia (with Gather) - Natural Gas	3,499.00
X-SFR-09	Double Sided Fire River - Brushed Steel Enclosure (with Gather) - Natural Gas	2,818.80
X-SFR-18	Double Sided Fire River - Brushed Steel Trim (with Full Glass Panel)	428.00
X-SFR-22	Double Sided Fire River - Matt Black Enclosure (with Gather) - Natural Gas	2,828.00
X-SFR-11	Double Sided Fire River - Polished Steel Enclosure (with Gather) - Natural Gas	3,347.80
X-SFR-19	Double Sided Fire River - Satin Black Trim (with Full Glass Panel)	338.00
X-FW-02	Double Sided Fire Wave (265) - Brushed Steel Enclosure (with Gather) - Natural Gas	4,299.00
X-FW-07	Double Sided Fire Wave (265) - Brushed Steel Trim (with Full Glass Panel)	648.00
X-FW-32	Double Sided Fire Wave (265) - Matt Black Enclosure (with Gather) - Natural Gas	4,647.00
X-FW-36	Double Sided Fire Wave (265) - Satin Black Steel Trim (with Full Glass Panel)	548.00
X-DST-01	Double Sided Stela Fire - Brushed Steel Enclosure (with Gather) - Natural Gas	3,781.00
X-DST-04	Double Sided Stela Fire - Brushed Steel Trim (with Full Glass Panel)	608.00
X-DST-02	Double Sided Stela Fire - Matt Black Enclosure (with Gather) - Natural Gas	4,089.00
X-DST-03	Double Sided Stela Fire - Satin Black Trim (with Full Glass Panel)	518.00
X-FR-50	Fire Ribbon - Matt Black Enclosure & 1pc Black Granite Fascia (without Gather) - Natural Gas	3,292.90
X-FR-06	Fire Ribbon - Polished Steel Enclosure & 1pc Black Granite Fascia (without Gather) - Natural Gas	3,192.90
X-FR-07	Fire Ribbon - Polished Steel Enclosure & 1pc Creme Travertine Fascia (without Gather) - Natural Gas	3,092.90
X-FR-05	Fire Ribbon - Polished Steel Enclosure & 1pc Limestone Fascia (without Gather) - Natural Gas	3,067.90
X-FR-14	Fire Ribbon - Polished Steel Enclosure & 4pc Black Granite Fascia (without Gather) - Natural Gas	2,842.90
X-FR-12	Fire Ribbon - Polished Steel Enclosure & 4pc Limestone Fascia (without Gather) - Natural Gas	2,792.90
X-FR-17	Fire Ribbon - Polished Steel Enclosure & 4pc Madre Perle Fascia (without Gather) - Natural Gas	2,792.90
X-SFR-14	Fire River - 4pc Black Granite Fascia (including bracket)	475.00
X-SFR-13	Fire River - 4pc Limestone Fascia (including bracket)	425.00
X-SFR-15	Fire River - 4pc Madre Perle Fascia (including bracket)	425.00
X-SFR-04	Fire River - Brushed Steel Enclosure (with Gather) - Natural Gas	1,896.80
X-SFR-03	Fire River - Brushed Steel Enclosure (without Gather) - Natural Gas	1,647.80
X-SFR-48	Fire River - Matt Black Enclosure (with Gather) - Natural Gas	2,075.80
X-SFR-47	Fire River - Matt Black Enclosure (without Gather) - Natural Gas	1,826.80
X-SFR-16	Fire River - Polished Steel Enclosure (with Gather) - Natural Gas	2,445.80
X-SFR-10	Fire River - Polished Steel Enclosure (without Gather) - Natural Gas	2,196.80

SPIRIT FIRES LIMITED

Printed: 22/09/2021

SKU	Product Name	RRP (inc VAT)
P-CC084	Fire River Brushed Steel Trim - Rev 6	279.00
P-CC101	Fire River PCS Black Steel Trim - Rev 6	189.00
X-FW-01	Fire Wave (175) - Brushed Steel Enclosure (with Gather) - Natural Gas	3,299.00
X-FW-35	Fire Wave (175) - Matt Black Enclosure (with Gather) - Natural Gas	3,697.00
X-FW-09	Fire Wave (175) - Polished Steel Enclosure (with Gather) - Natural Gas	3,898.00
P-CC355	Fire Wave (175) Brushed Steel Trim - Rev 2	399.00
P-CC325	Fire Wave (175) PCS Black Trim - Rev 2	299.00
X-FW-31	Fire Wave (265) - 4pc Black Granite Fascia (including bracket)	849.00
X-FW-30	Fire Wave (265) - 4pc Limestone Fascia (including bracket)	549.00
X-FW-06	Fire Wave (265) - 4pc Madre Perle Fascia (including bracket)	549.00
X-FW-20	Fire Wave (265) - Brushed Steel Enclosure (with Gather) - Natural Gas	3,398.00
X-FW-34	Fire Wave (265) - Matt Black Enclosure (with Gather) - Natural Gas	3,796.00
X-FW-23	Fire Wave (265) - Polished Steel Enclosure (with Gather) - Natural Gas	3,997.00
P-CC058	Fire Wave (265) Brushed Steel Trim - Rev 1	399.00
P-CC057	Fire Wave (265) PCS Black Trim - Rev 1	299.00
X-FB-02	Firebreak Fire - Black Granite Suite (with Gather) - Natural Gas	4,508.50
X-FB-01	Firebreak Fire - Limestone Suite (with Gather) - Natural Gas	4,158.50
P-KC190	FR1200/Stela 30pc Pebble Set [Mixed]	119.00
X-BOX-104	FR1500 Single Sided Gas Burner with Polished Steel Shelves -NG [spec 87]	2,487.00
P-KC175	FR1500/Fire Wave 19pc Log Set [BL-6/3/3/10/14/8/6/15/5/13/11/4/8/17/14/16/10/9]	227.20
P-KC188	FR1500/Fire Wave 45pc Pebble Set [Mixed]	139.00
P-KC167	FR850/Fire River 20pc Pebble Set [Mixed]	89.99
P-CC412	FR850/Fire River/Ribbon PCS Black Gather (125 & 175) - Rev 2	249.00
P-KC168	FR850/FR920HE/FR1200 14pc Log Set [BL4,3,9,13,14,17,5,8,15,11,16,6,10,12a]	179.00
P-CC106	Stela Brushed Steel Trim - Rev 1	299.00
X-ST-01	Stela Fire - Brushed Steel Enclosure (with Gather) - Natural Gas	2,864.00
X-ST-03	Stela Fire - Matt Black Enclosure (with Gather) - Natural Gas	3,113.00
X-ST-02	Stela Fire - Polished Steel Enclosure (with Gather) - Natural Gas	3,413.00
P-CC105	Stela PCS Black Trim - Rev 1	299.00

Note: Only the Natural Gas version is shown on the price list however fires are also available for use with LPG/Propane. To calculate the price of the LPG/Propane version add £44. Prices valid for 30 days from published date below and include VAT @ 20%. For the latest offers and to place your order **Call Sales on 01325-301020, Monday to Saturday 9am to 6pm**. For images, videos and technical specifications visit our web site at www.cvo.co.uk. Fires are available for all installation types and fuel types – gas, wood, bioethanol and electric. To receive information on our other ranges, call sales. Trade accounts are set up upon application.

Spirit Fires Ltd, Unit 4, Beaumont Square, Durham Way South, Newton Aycliffe, County Durham, DL5 6XN

Class 2 Gas Fires



RETAIL PRICE LIST

SKU	Product Name	RRP (inc VAT)
P-KC009	Bailey/FR520 7pc Log Set [BL3a:6a:8a:10a:11a:14a:15a][FE026]	99.99
X-BOR-001	Bordino Fire - Black Granite Suite (without Gather) - Natural Gas	2,198.00
X-BOR-002	Bordino Fire - Rigel Suite (without Gather) - Natural Gas	1,999.00
X-CS-04	Cast Slit Fire - Satin Black Enclosure & Brushed Steel Flat Trim - Natural Gas	1,898.00
X-CS-03	Cast Slit Fire - Satin Black Enclosure & Satin Black Flat Trim - Natural Gas	1,798.00
X-CS-10	Cast Slit Fire - Satin Black Enclosure (Trimless) - Natural Gas	1,698.00
P-CC115	Cast Slit PCS Black Gather - Rev 3	199.00
X-CFR-06	Compact Fire Ribbon - Polished Steel Enclosure & 1pc Black Granite Fascia (without Gather) - Natural Gas	2,399.00
X-CFR-12	Compact Fire Ribbon - Polished Steel Enclosure & 1pc Creme Travertine Fascia (without Gather) - Natural Gas	2,299.00
X-CFR-05	Compact Fire Ribbon - Polished Steel Enclosure & 1pc Limestone Fascia (without Gather) - Natural Gas	2,299.00
X-CFR-09	Compact Fire Ribbon - Polished Steel Enclosure & 4pc Black Granite Fascia (without Gather) - Natural Gas	2,099.00
X-CFR-08	Compact Fire Ribbon - Polished Steel Enclosure & 4pc Limestone Fascia (without Gather) - Natural Gas	1,999.00
X-CFR-10	Compact Fire Ribbon - Polished Steel Enclosure & 4pc Madre Perle Fascia (without Gather) - Natural Gas	1,999.00
X-CFR-13	Compact Fire Ribbon - Polished Steel Enclosure & 4pc Rigel Fascia (without Gather) - Natural Gas	1,899.00
X-MAD-18	Double Sided Madini Fire - Brushed Steel Enclosure (with Gather) & Log Set - Natural Gas	2,331.99
X-MAD-11	Double Sided Madini Fire - Brushed Steel Enclosure (with Gather) & Pebble Set - Natural Gas	2,232.99
X-MAD-06	Double Sided Madini Fire - Brushed Steel Trim (with Full Glass Panel)	449.00
X-MAD-17	Double Sided Madini Fire - Matt Black Enclosure (with Gather) & Log Set - Natural Gas	2,131.99
X-MAD-07	Double Sided Madini Fire - Matt Black Enclosure (with Gather) & Pebble Set - Natural Gas	2,089.00
X-MAD-08	Double Sided Madini Fire - Matt Black Trim (with Full Glass Panel)	449.00
X-MAD-19	Double Sided Madini Fire - Polished Steel Enclosure (with Gather) & Log Set - Natural Gas	2,481.99
X-MAD-20	Double Sided Madini Fire - Polished Steel Enclosure (with Gather) & Pebble Set - Natural Gas	2,382.99
X-ESS-08	Essence Fire - Brushed Steel Enclosure & Brushed Steel Trim (with Gather) - Natural Gas	1,797.00
X-ESS-07	Essence Fire - Brushed Steel Enclosure & Brushed Steel Trim (without Gather) - Natural Gas	1,598.00
X-ESS-06	Essence Fire - Brushed Steel Enclosure & Satin Black Trim (with Gather) - Natural Gas	1,797.00
X-ESS-05	Essence Fire - Brushed Steel Enclosure & Satin Black Trim (without Gather) - Natural Gas	1,598.00
X-ESS-11	Essence Fire - Matt Black Enclosure & Brushed Steel Fascia (without Gather) - Natural Gas	1,399.00
X-ESS-10	Essence Fire - Matt Black Enclosure & Satin Black Fascia (with Gather) - Natural Gas	1,598.00
X-ESS-09	Essence Fire - Matt Black Enclosure & Satin Black Fascia (without Gather) - Natural Gas	1,399.00
P-CC076	FR520/Essence/Compact Fire Ribbon PCS Black Gather - Rev 1	249.00
P-CC134	Madini Brushed Steel Flat Trim - Rev 1	189.00
X-MAD-16	Madini Fire - Brushed Steel Enclosure (with Gather) & Log Set - Natural Gas	1,687.00
X-MAD-05	Madini Fire - Brushed Steel Enclosure (with Gather) & Pebble Set - Natural Gas	1,588.00

SPIRIT FIRES LIMITED

Printed: 27/09/2021

SKU	Product Name	RRP (inc VAT)
X-MAD-15	Madini Fire - Brushed Steel Enclosure (without Gather) & Log Set - Natural Gas	1,487.00
X-MAD-04	Madini Fire - Brushed Steel Enclosure (without Gather) & Pebble Set - Natural Gas	1,388.00
X-MAD-13	Madini Fire - Matt Black Enclosure (with Gather) & Log Set - Natural Gas	1,637.00
X-MAD-02	Madini Fire - Matt Black Enclosure (with Gather) & Pebble Set - Natural Gas	1,538.00
X-MAD-12	Madini Fire - Matt Black Enclosure (without Gather) & Log Set - Natural Gas	1,437.00
X-MAD-01	Madini Fire - Matt Black Enclosure (without Gather) & Pebble Set - Natural Gas	1,338.00
P-CC498	Madini PCS Black Flat Trim - Rev 1	149.00
P-KC181	Madini/FR520 15pc Pebble Set [Mixed]	89.99

Note: Only the Natural Gas version is shown on the price list however fires are also available for use with LPG/Propane. To calculate the price of the LPG/Propane version add £44. Prices valid for 30 days from published date below and include VAT @ 20%. For the latest offers and to place your order **Call Sales on 01325-301020, Monday to Saturday 9am to 6pm**. For images, videos and technical specifications visit our web site at www.cvo.co.uk. Fires are available for all installation types and fuel types – gas, wood, bioethanol and electric. To receive information on our other ranges, call sales. Trade accounts are set up upon application.

Spirit Fires Ltd, Unit 4, Beaumont Square, Durham Way South, Newton Aycliffe, County Durham, DL5 6XN