

## NATIVA

### Installation manual

Dimensions:

120x180 cm

150x180 cm

150x200 cm

200x200 cm

200x250 cm

Handedness:

Right



# Leave space for better assembly

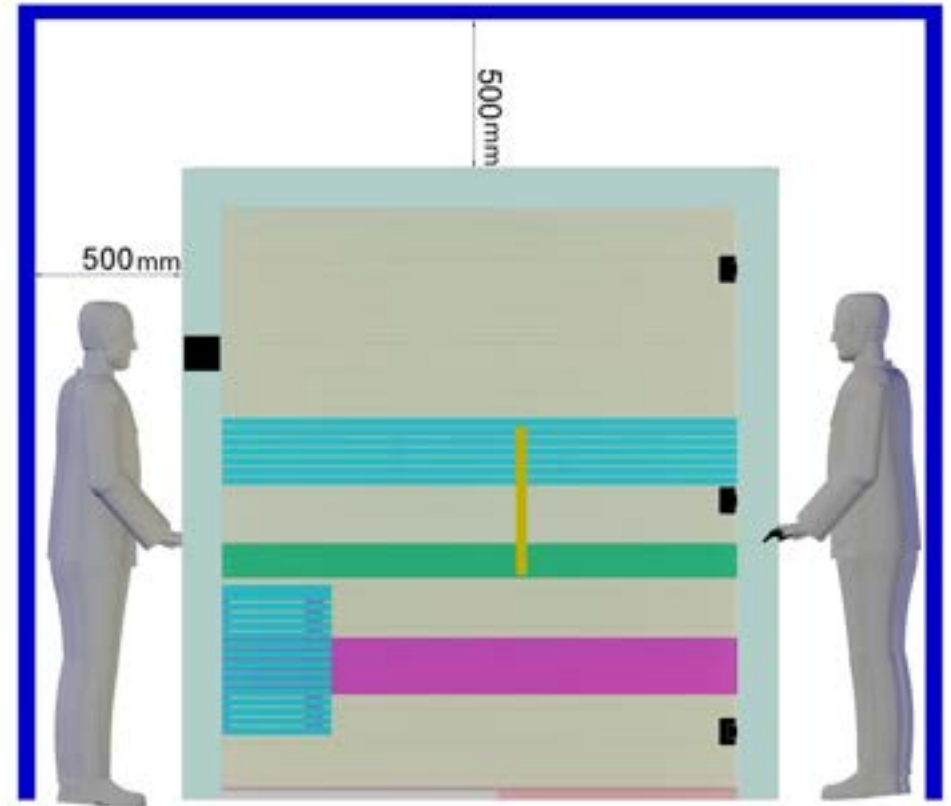
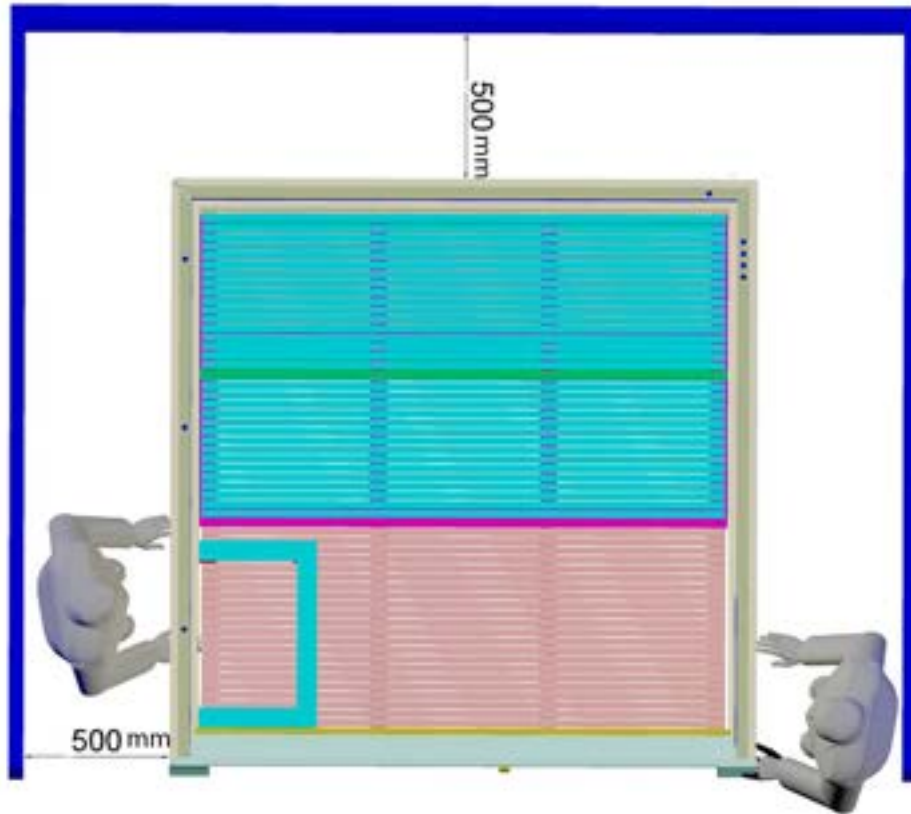

# Tools



# 1. Base frame

	x (mm)	y (mm)
120x180 cm	2088	1746
150x180 cm	2267	1746
150x200 cm	2424	1946
200x200 cm	2752	1946
200x250 cm	3126	2446

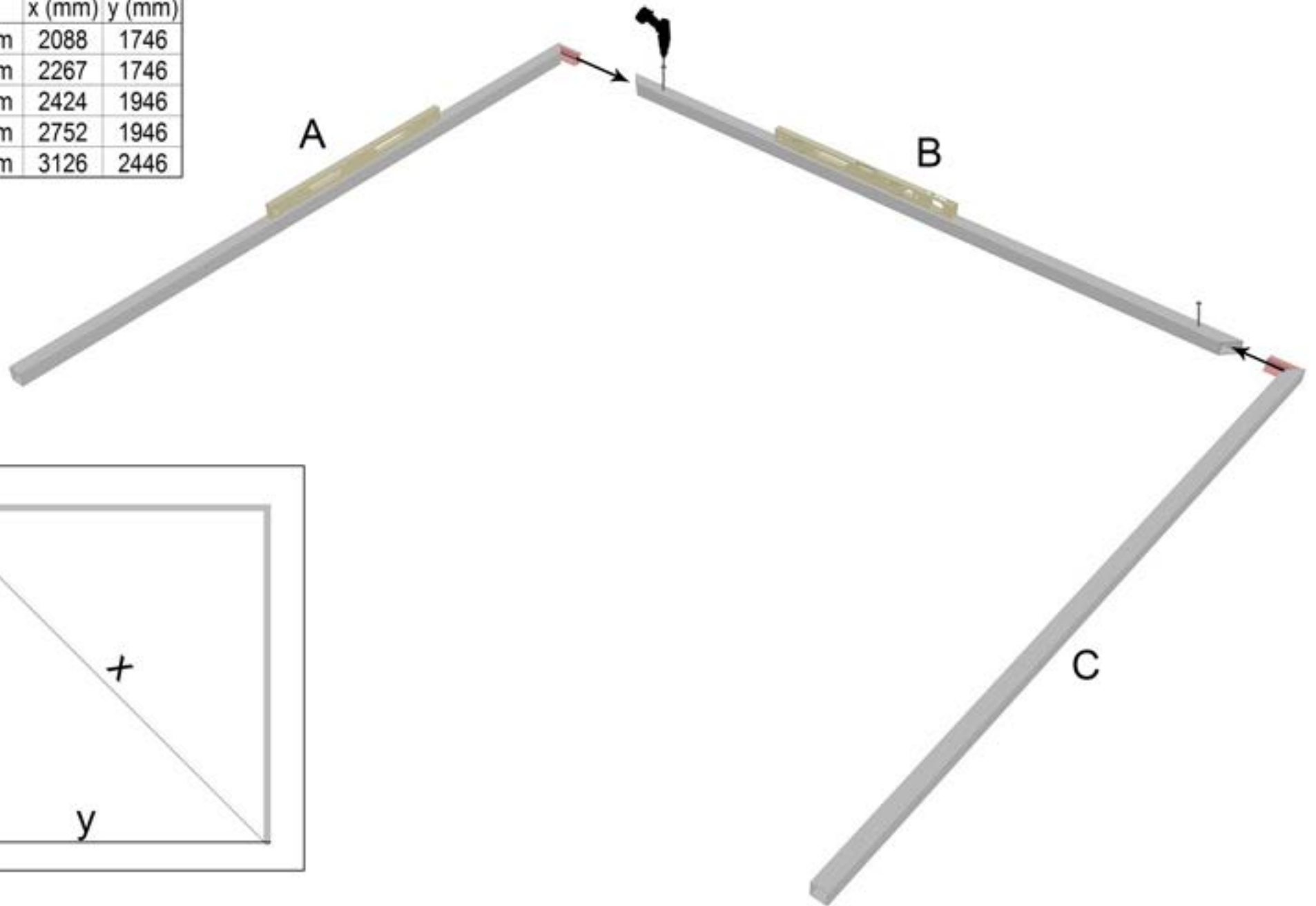

## 2. Walls

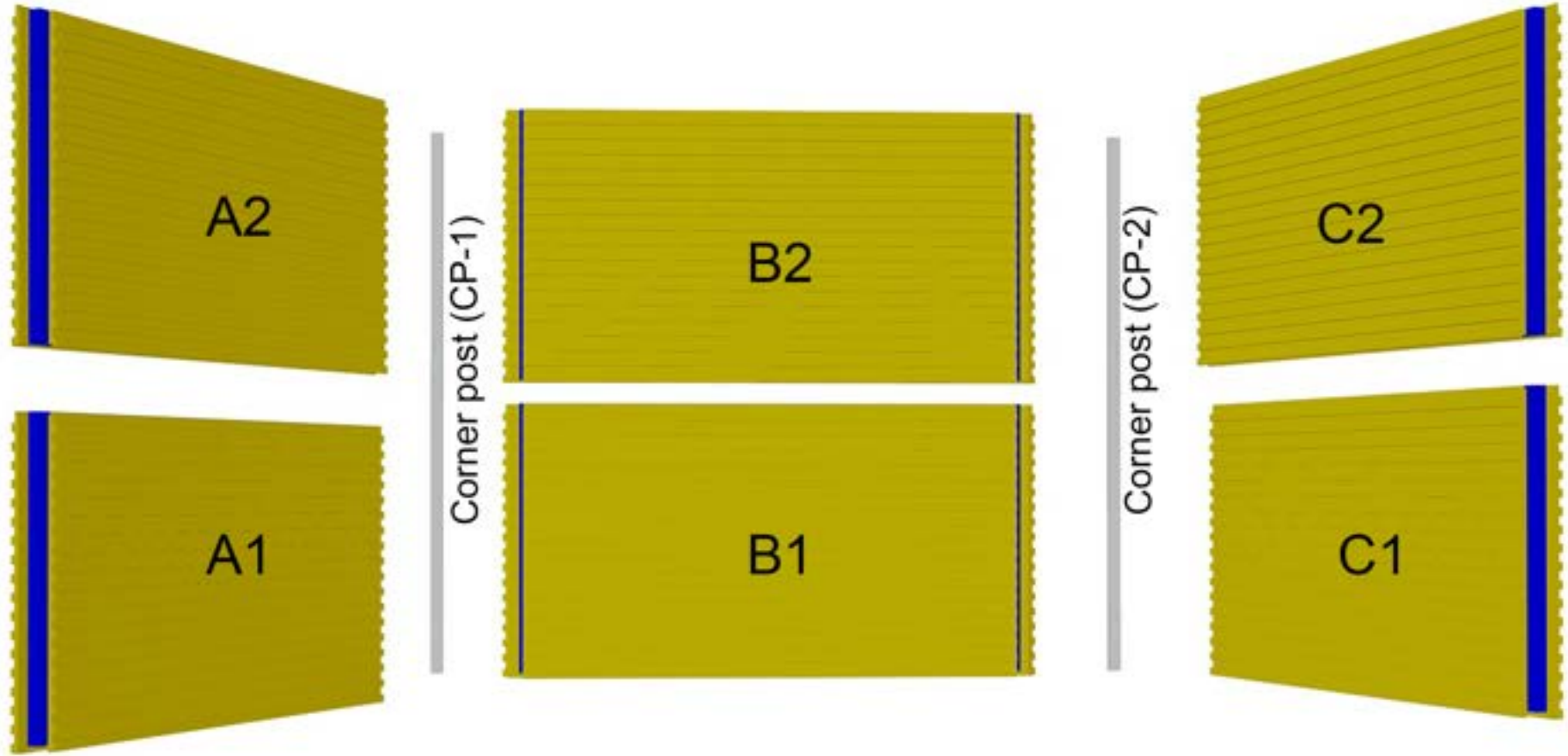

### 3. Multiclip closing system

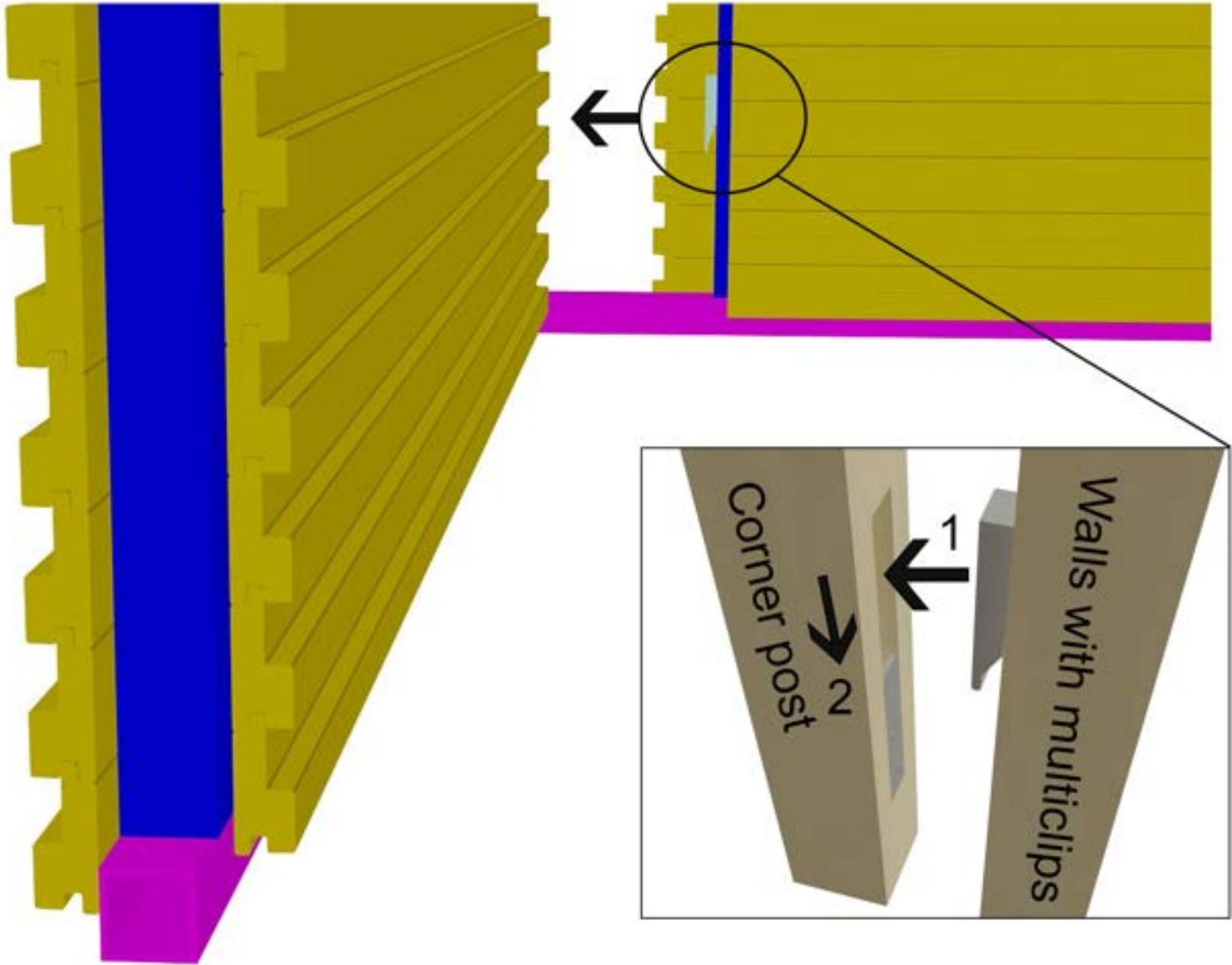

## 4. Fixing walls A1 & B1

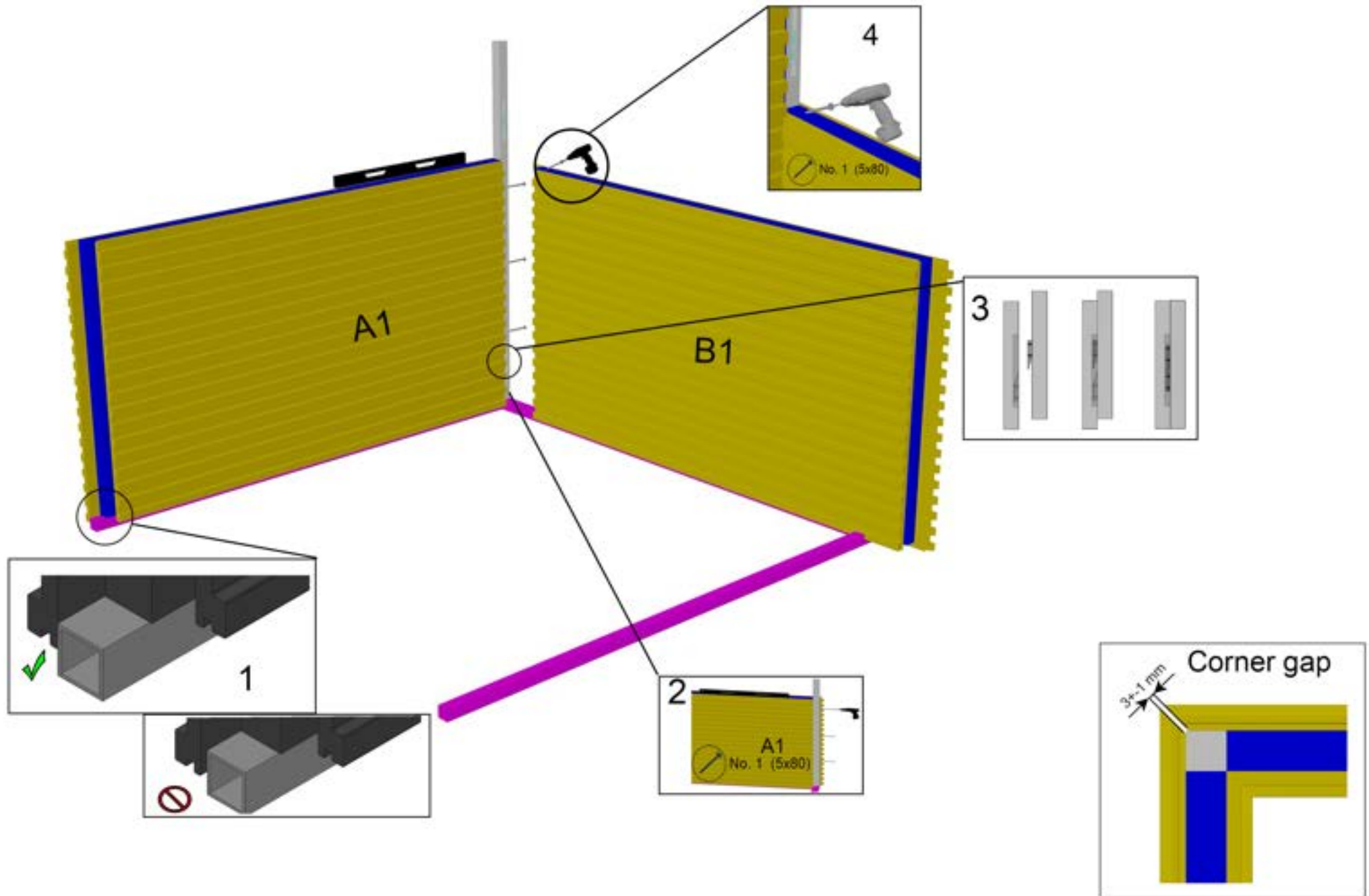

## 5. Fixing walls A2 & B2

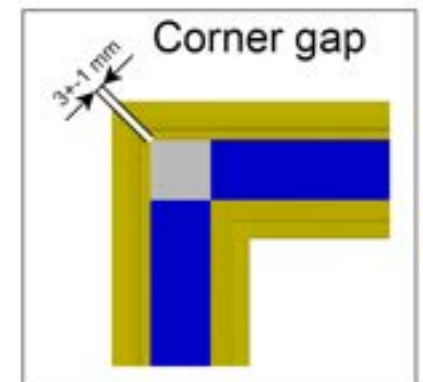
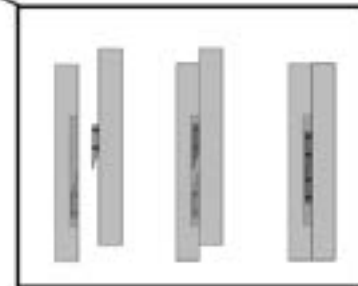
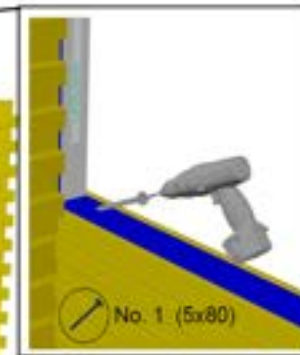
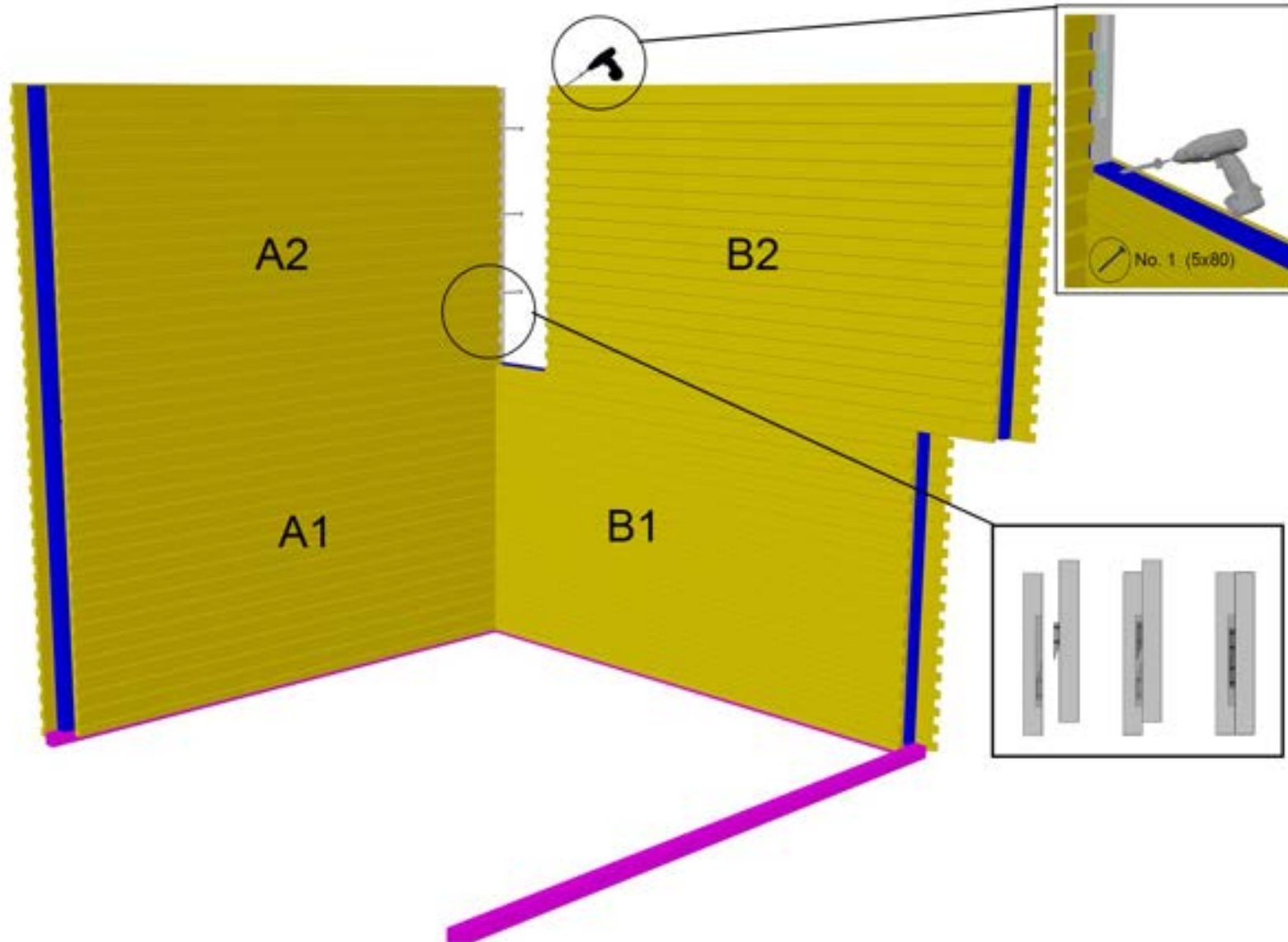



## 6. Fixing walls C1 & C2

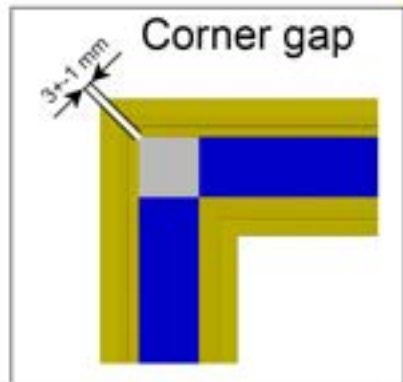
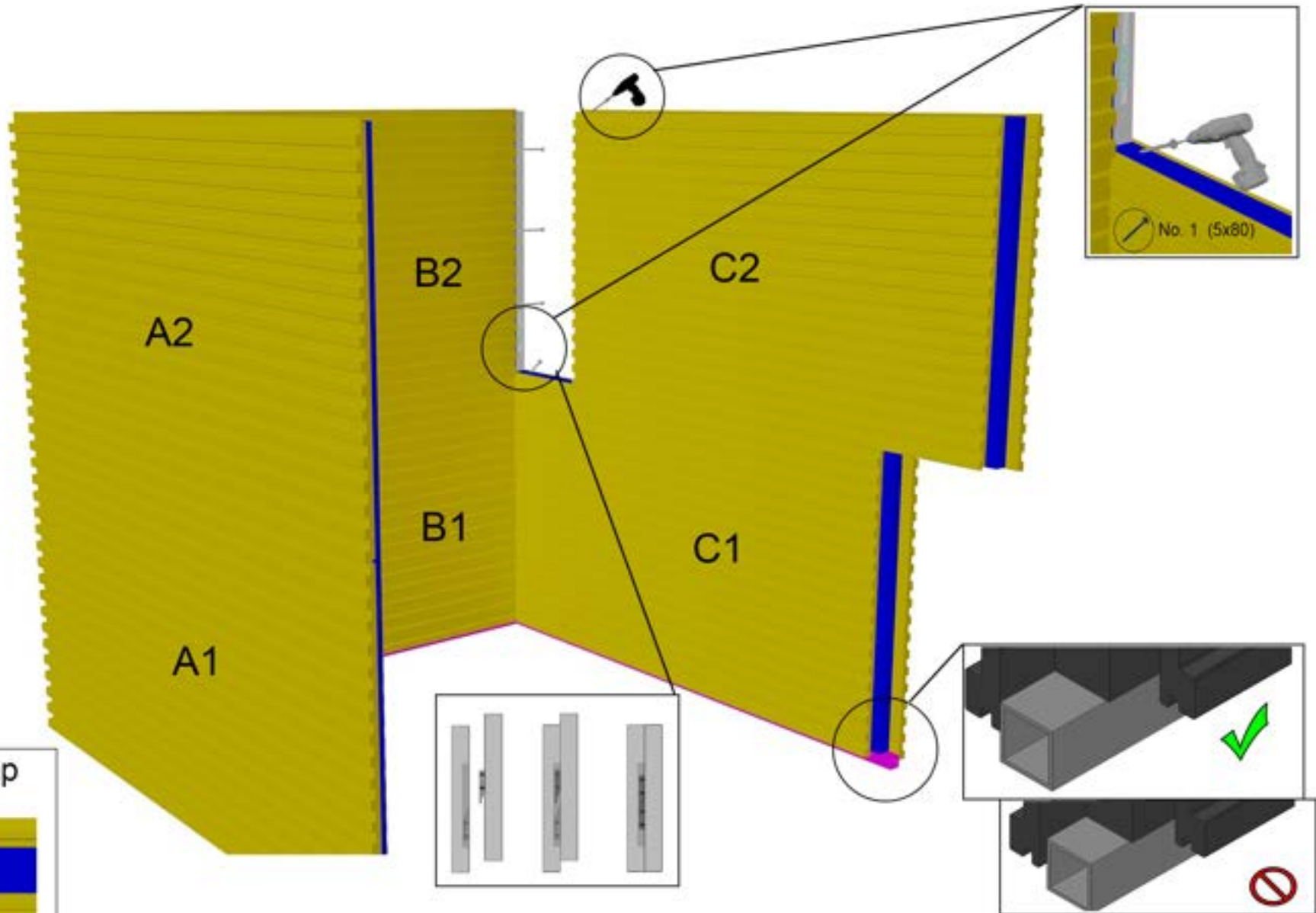

# 7. Fixing ceilings

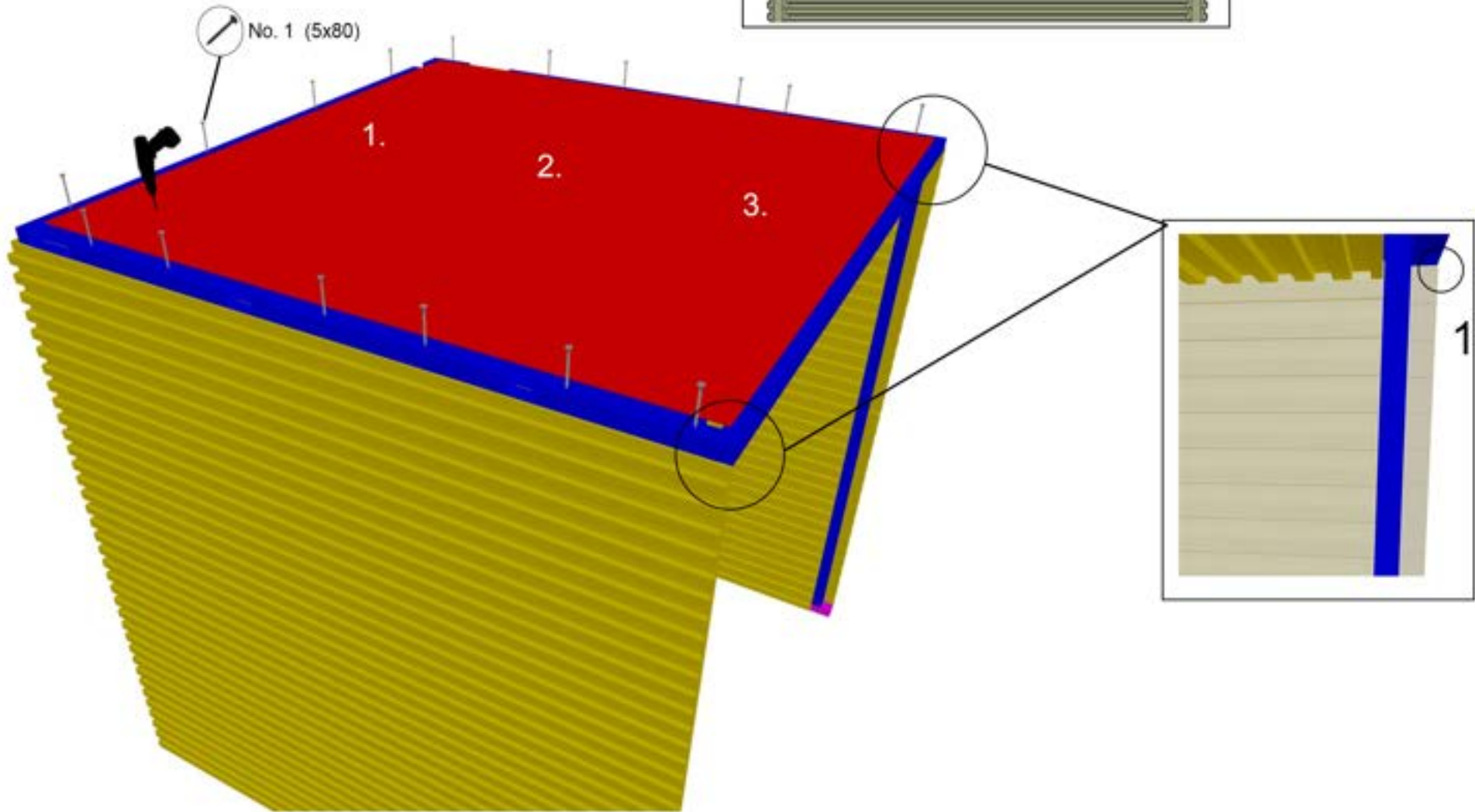
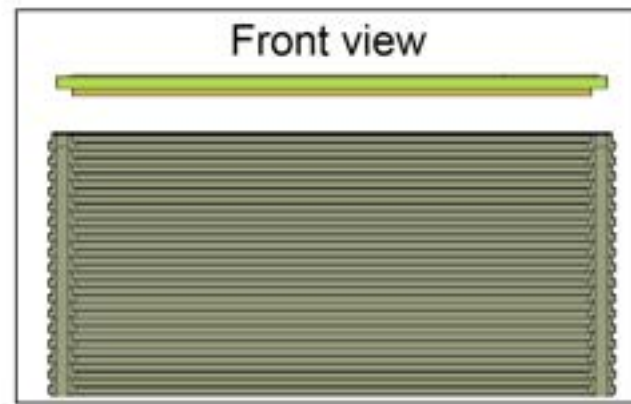

## 8. Interior 200x200 cm

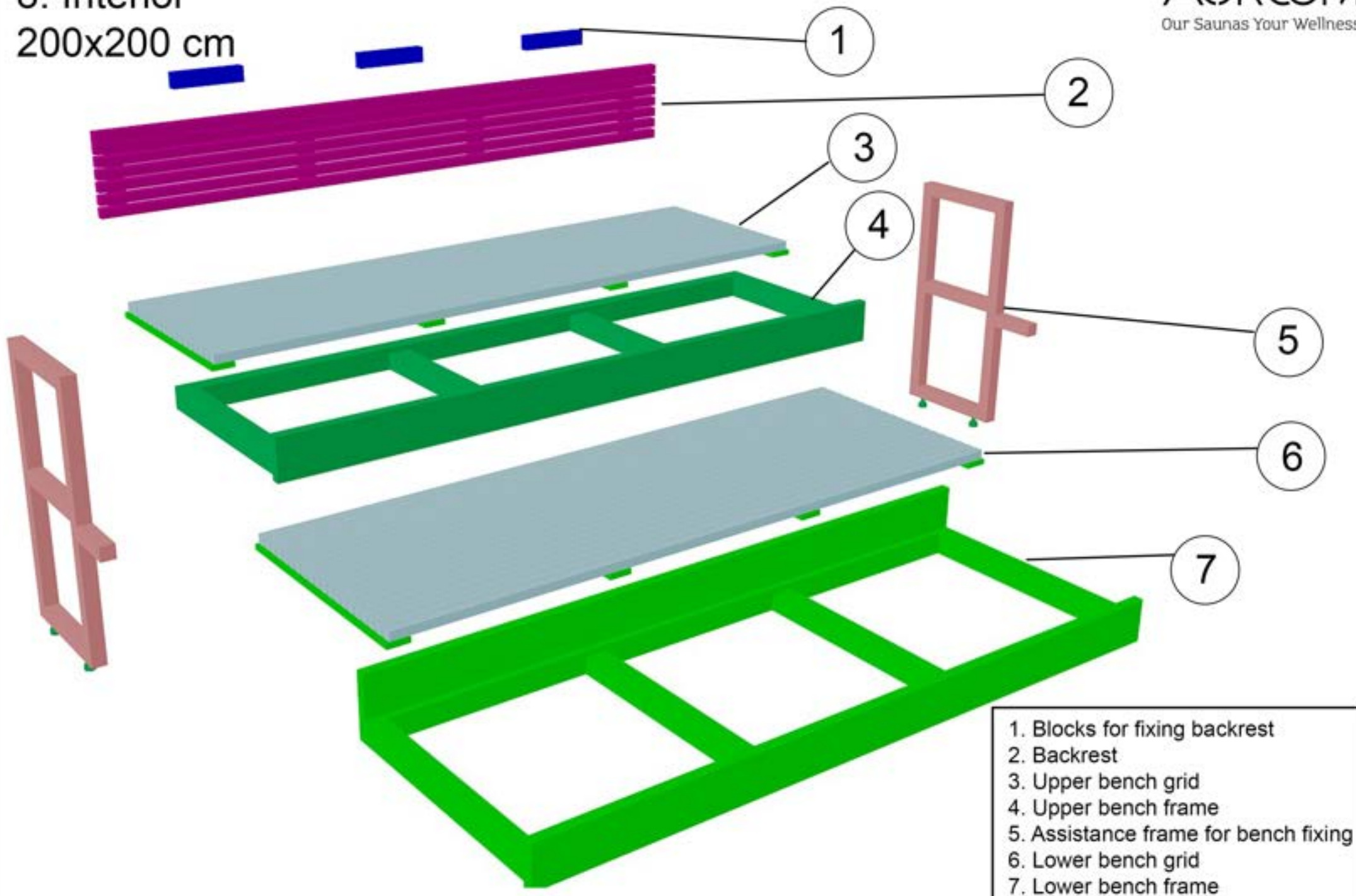

## 8.1 Interior 120x180 cm

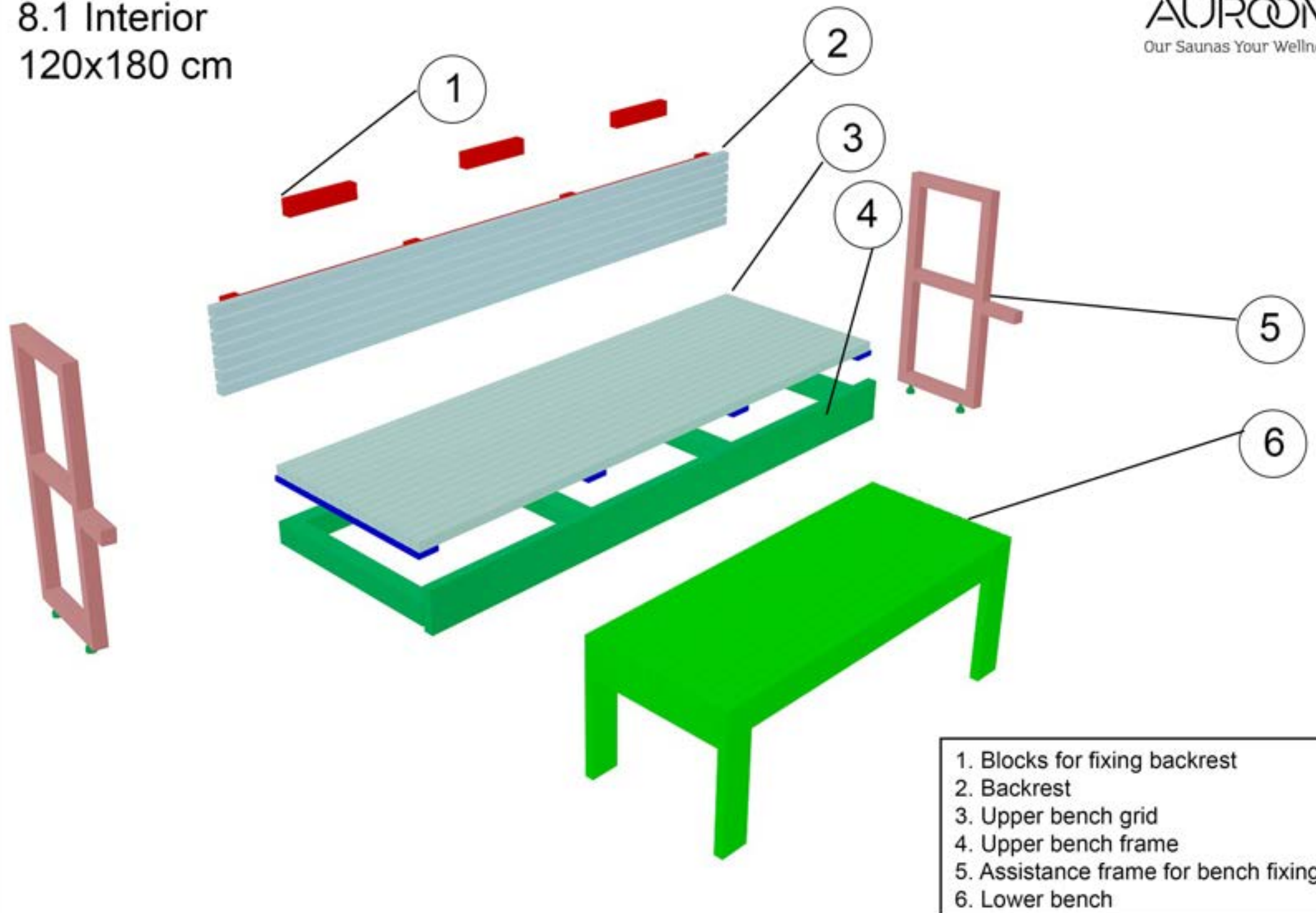

8.2 Interior  
150x180 cm  
150x200 cm

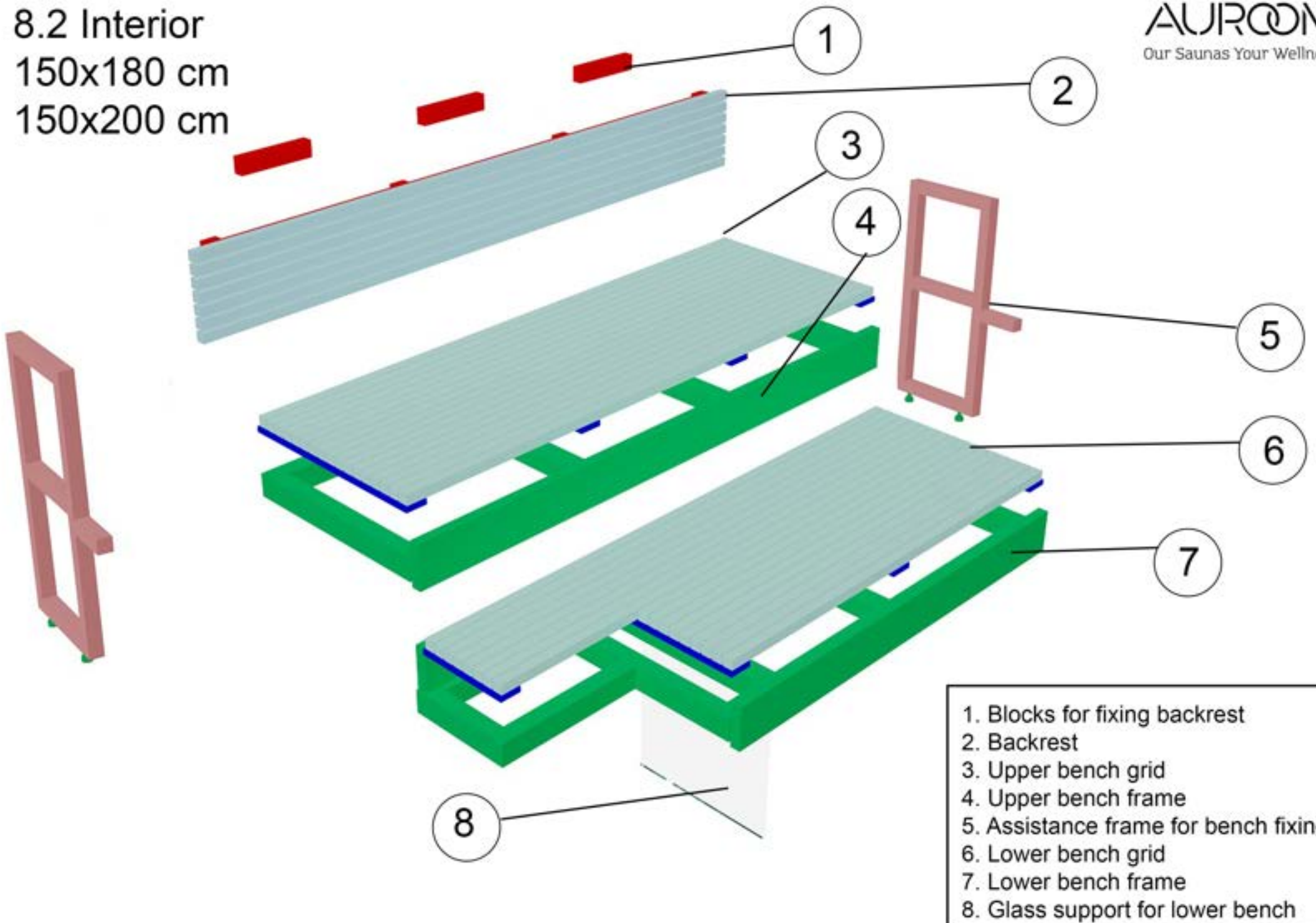

- 1. Blocks for fixing backrest
- 2. Backrest
- 3. Upper bench grid
- 4. Upper bench frame
- 5. Assistance frame for bench fixing
- 6. Lower bench grid
- 7. Lower bench frame
- 8. Glass support for lower bench

## 8.3 Interior 200x250 cm

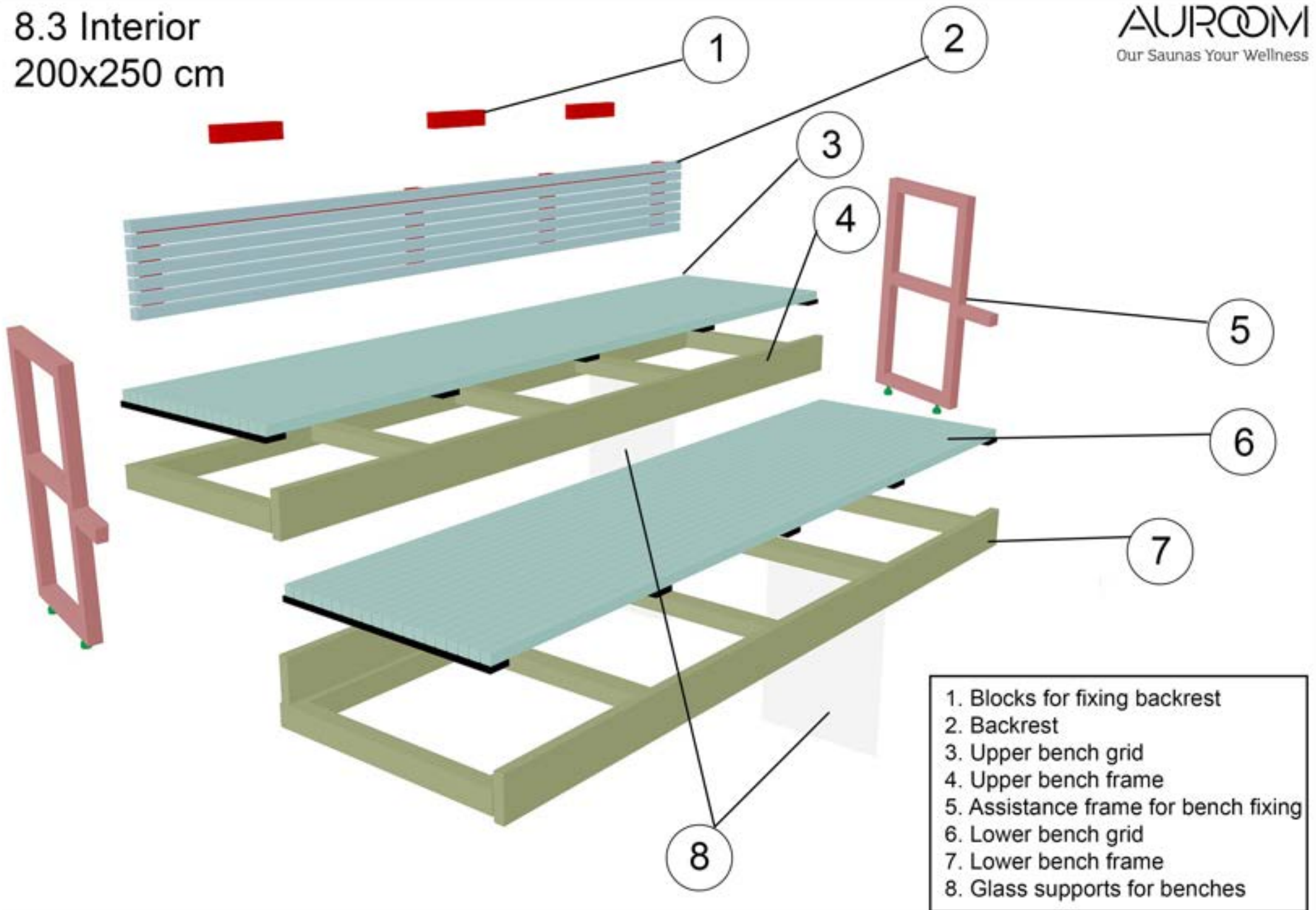

# 9. Assistance frames

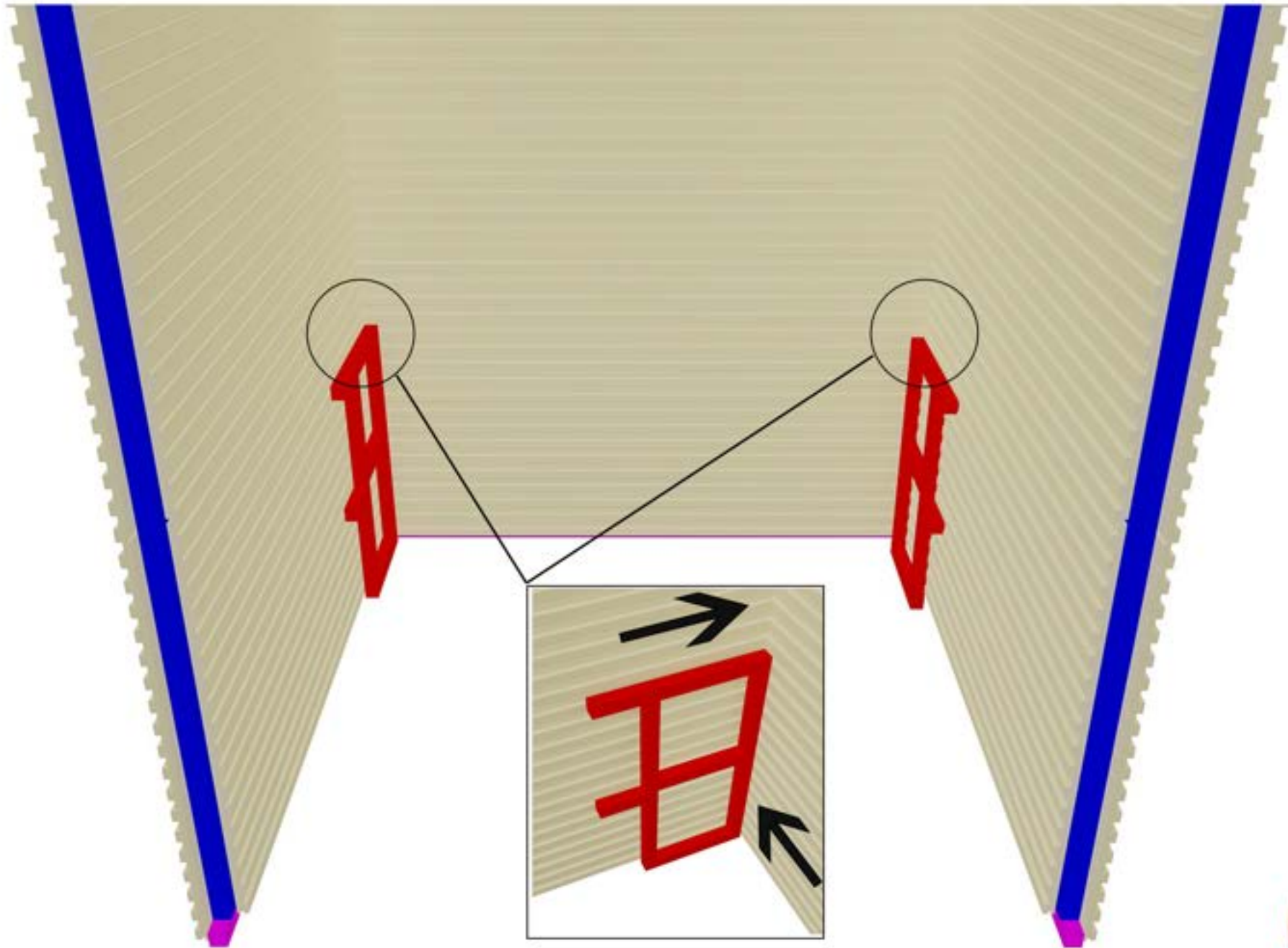

# 10. Bench frames and backrest blocks

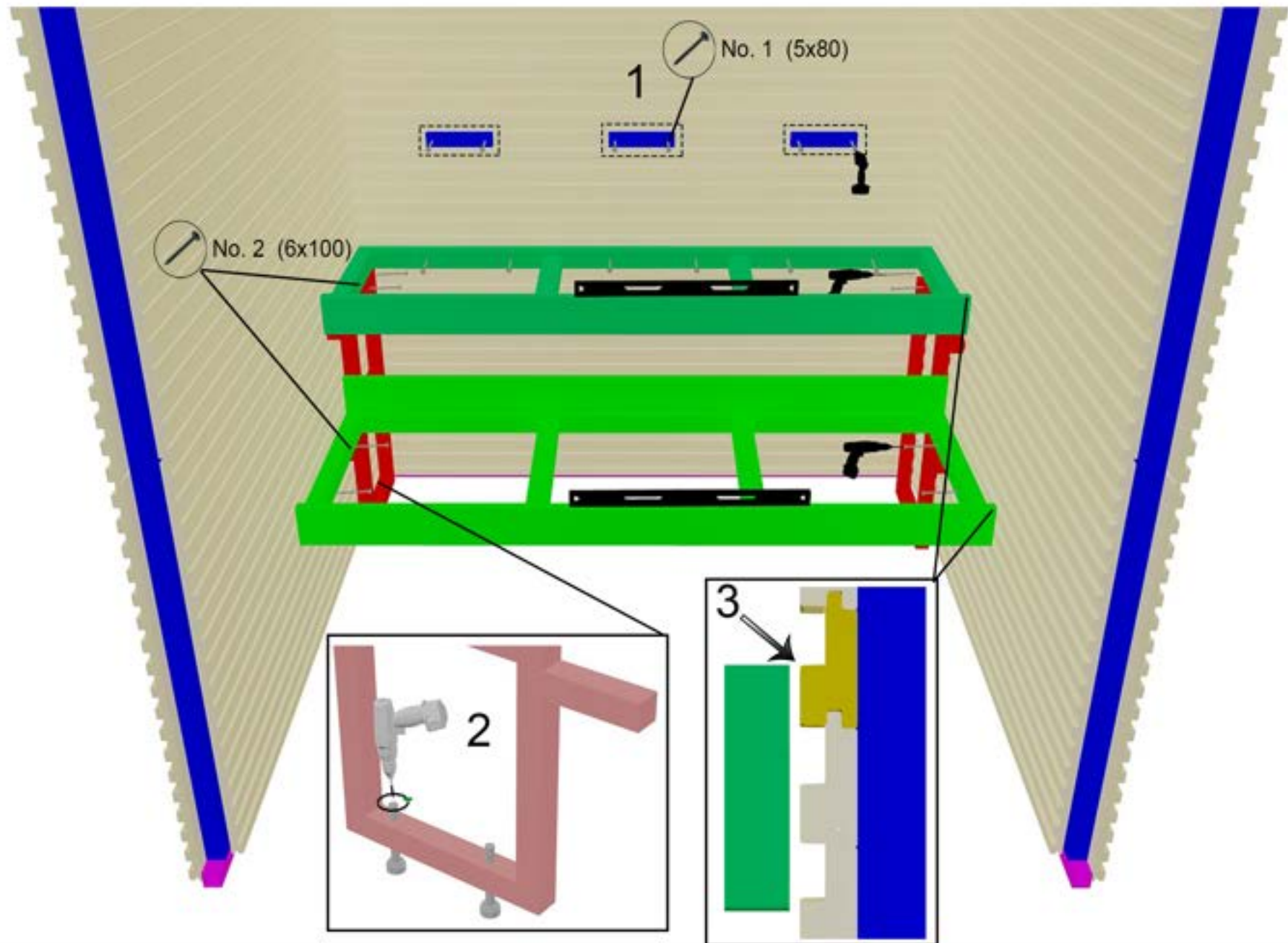



# 11. Removing assistance frames

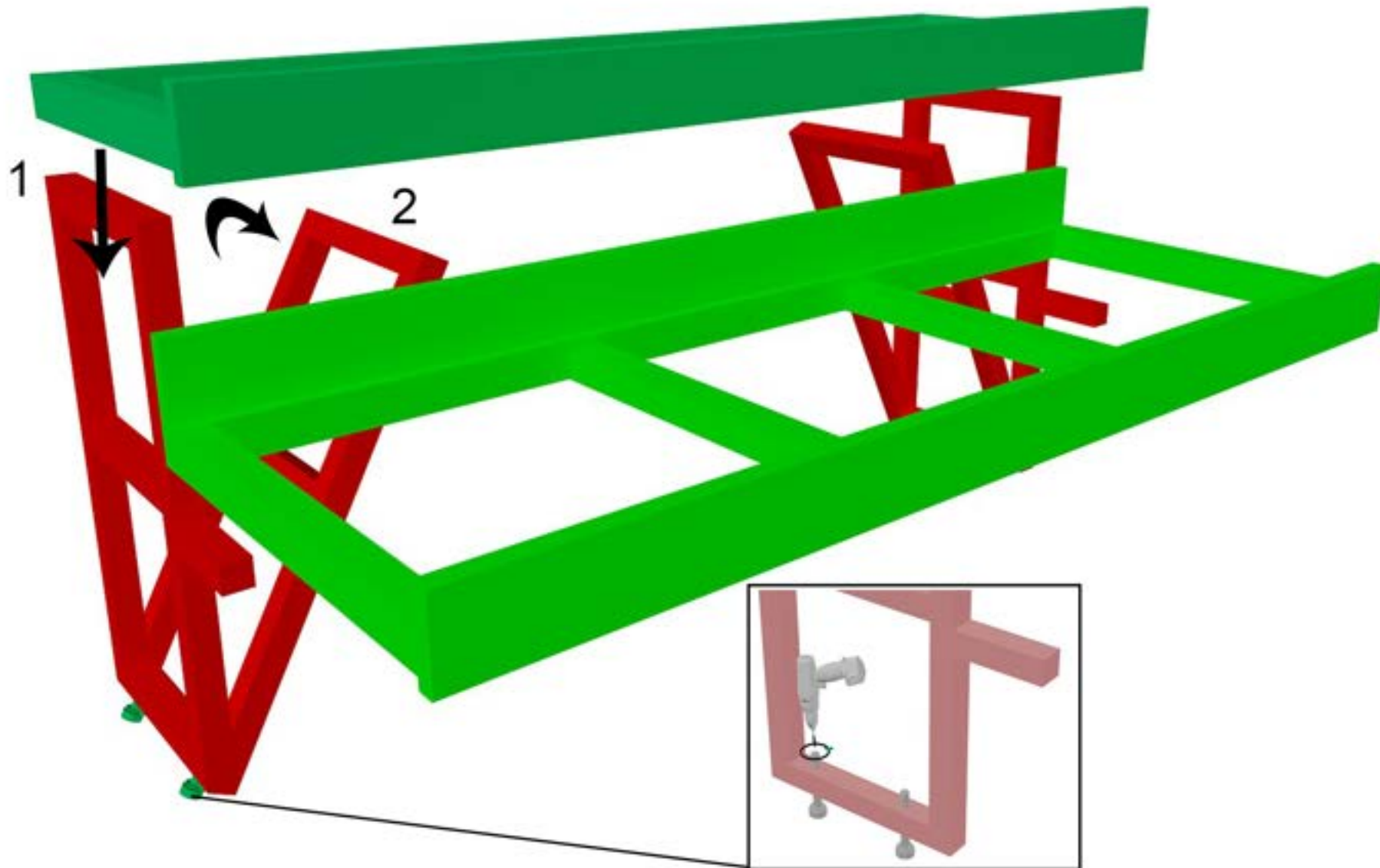

## 12. Wiring inside walls

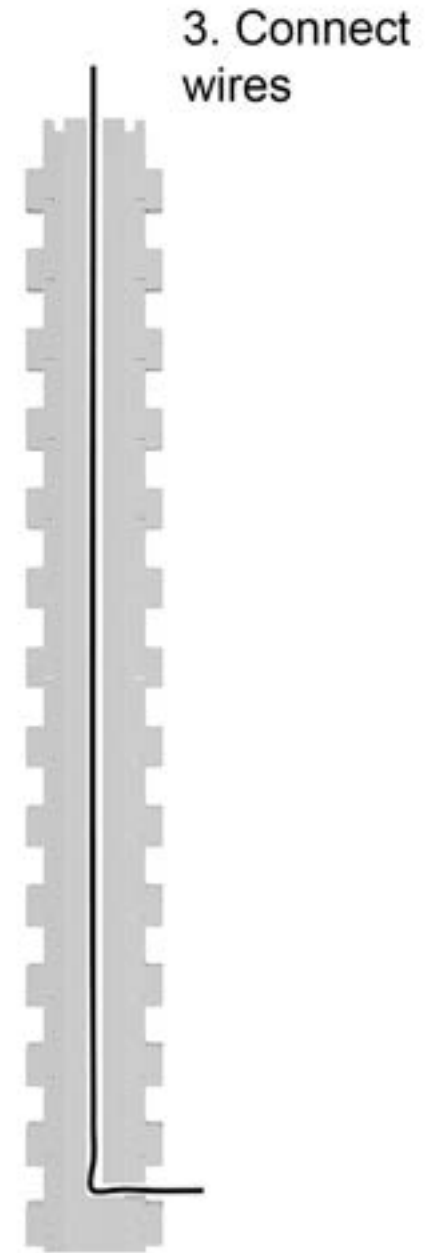
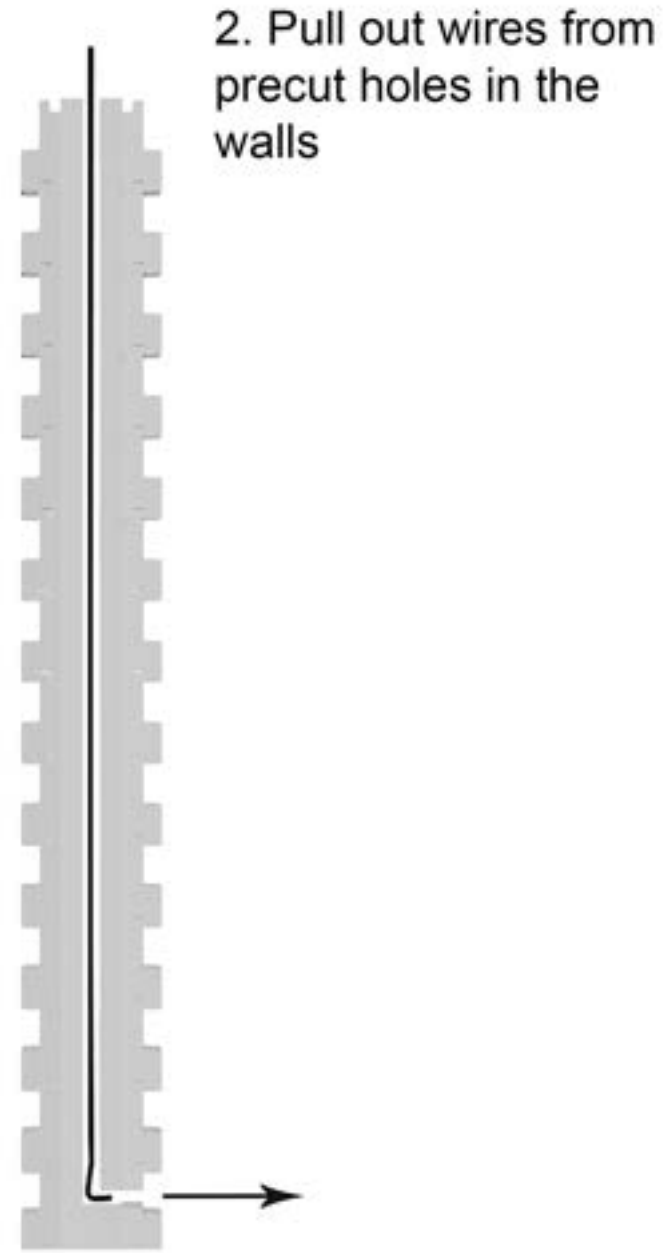
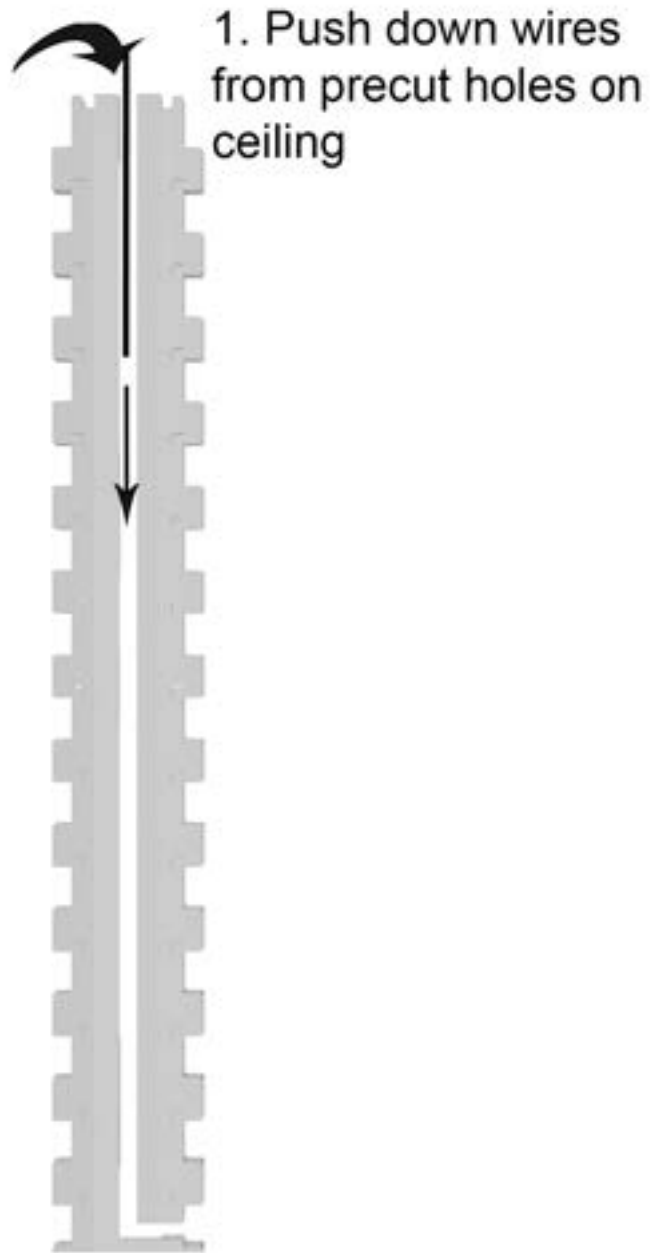

# 13. LED-strip connections

! Always use certified electrician

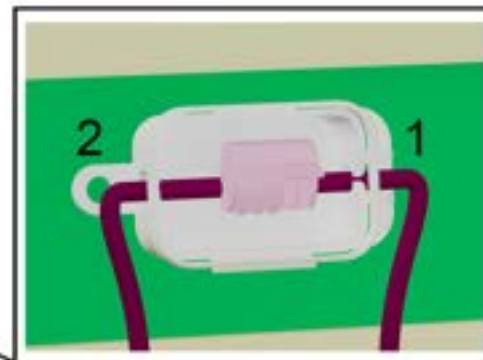
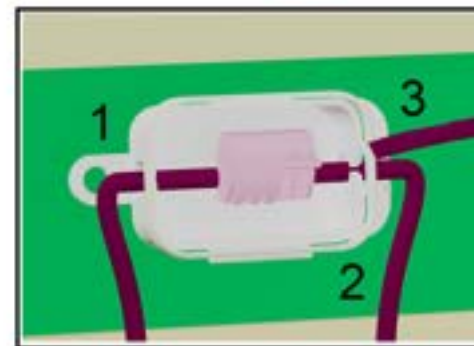
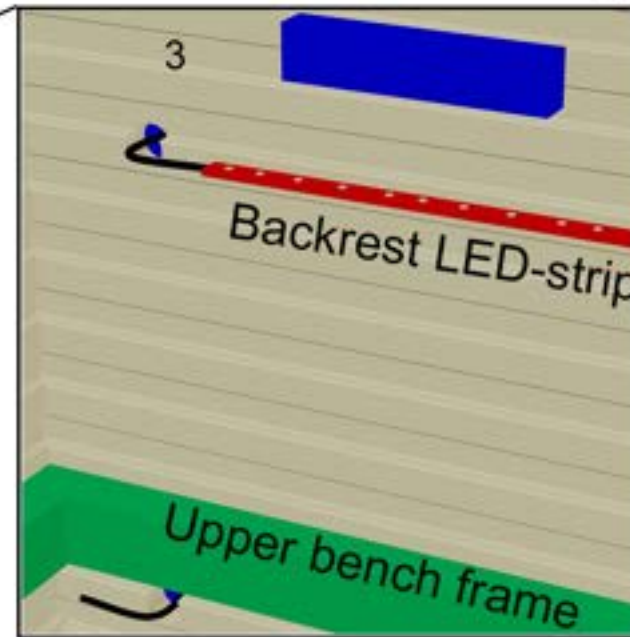
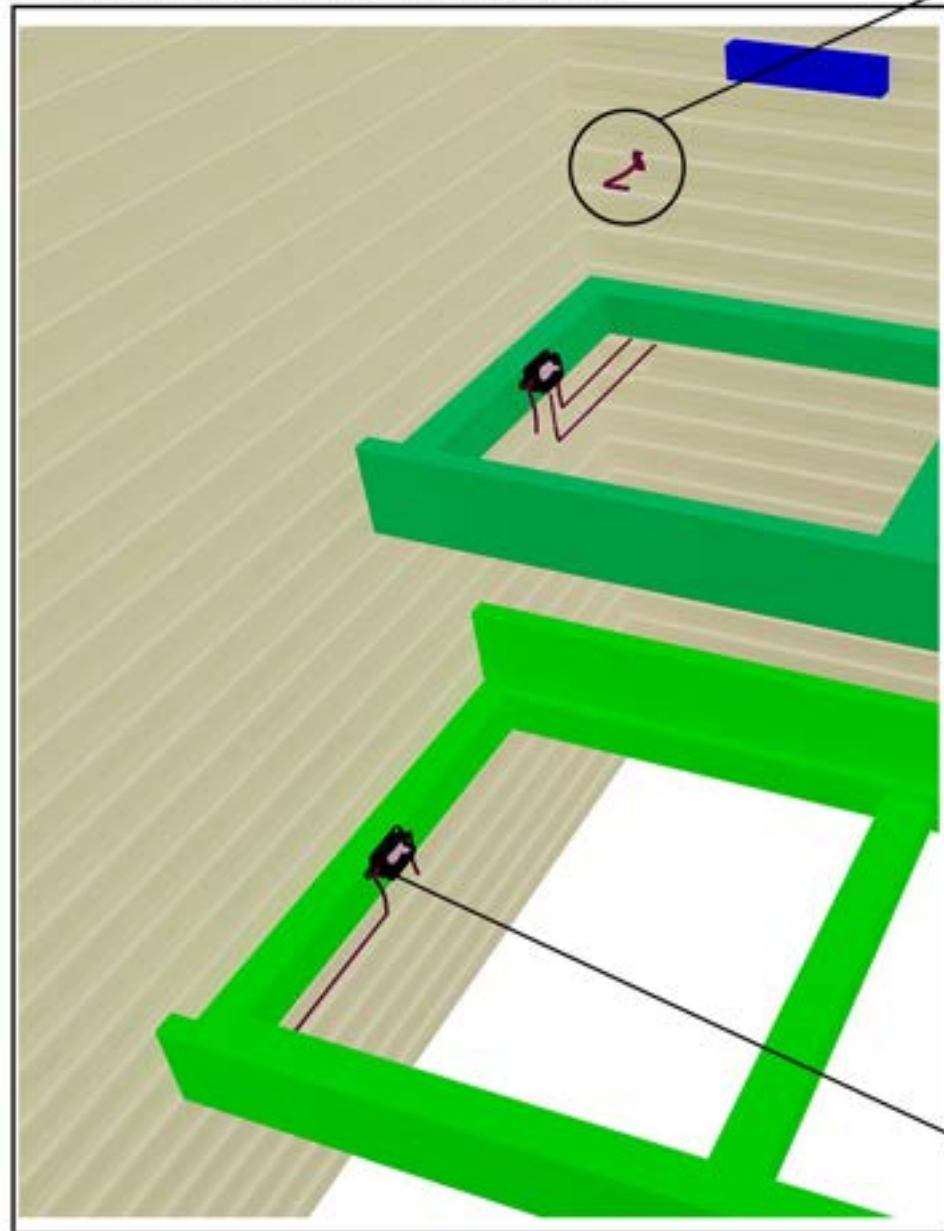

- 1. Wires from the ceiling
- 2. Bench LED-strip wires
- 3. Backrest LED-strip wire

# 14. Backrest & bench grids

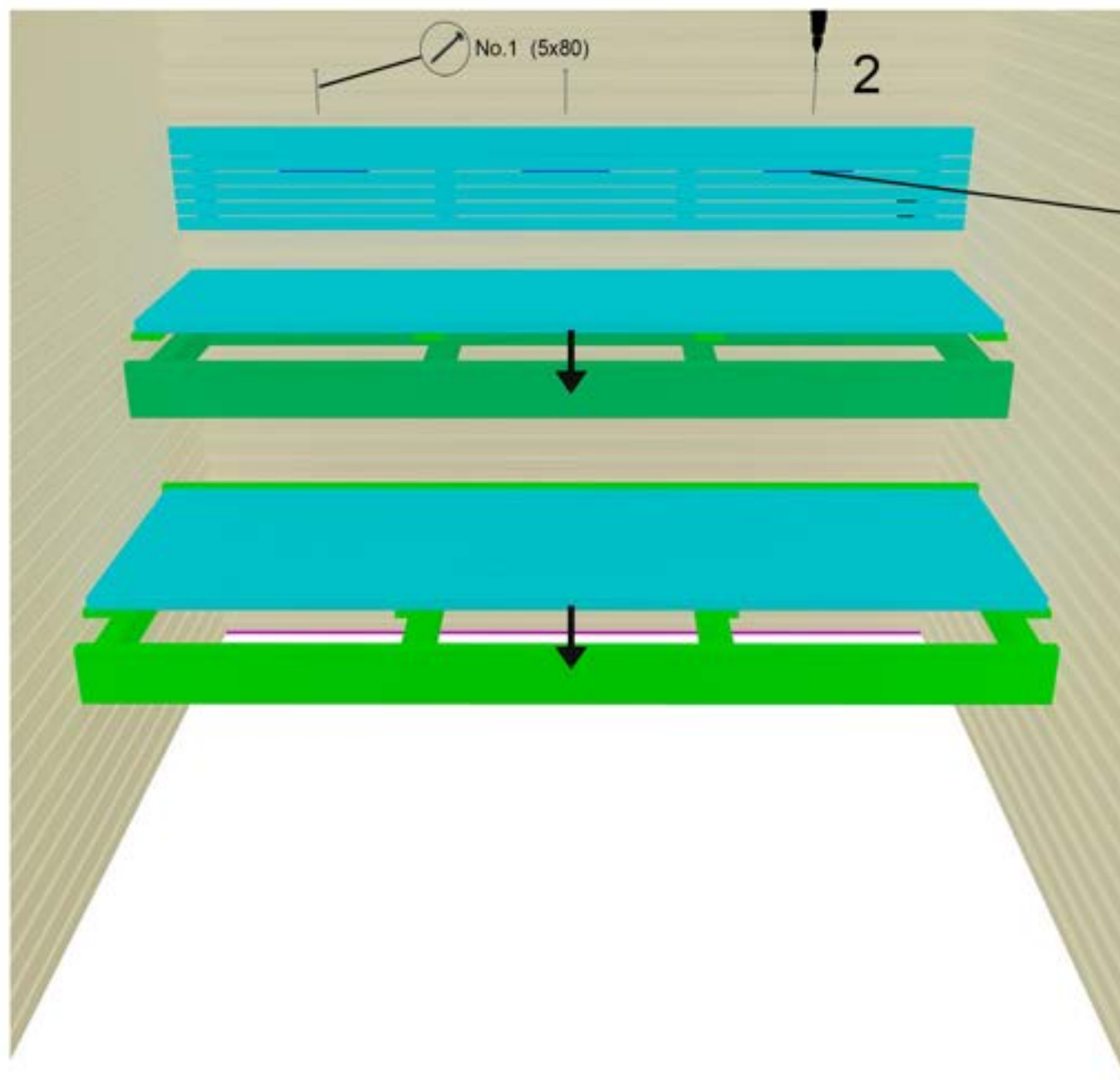

3. Fix LED-strip on top of backrest with glue (covers screws)

# 14.1 Fixing glass supports

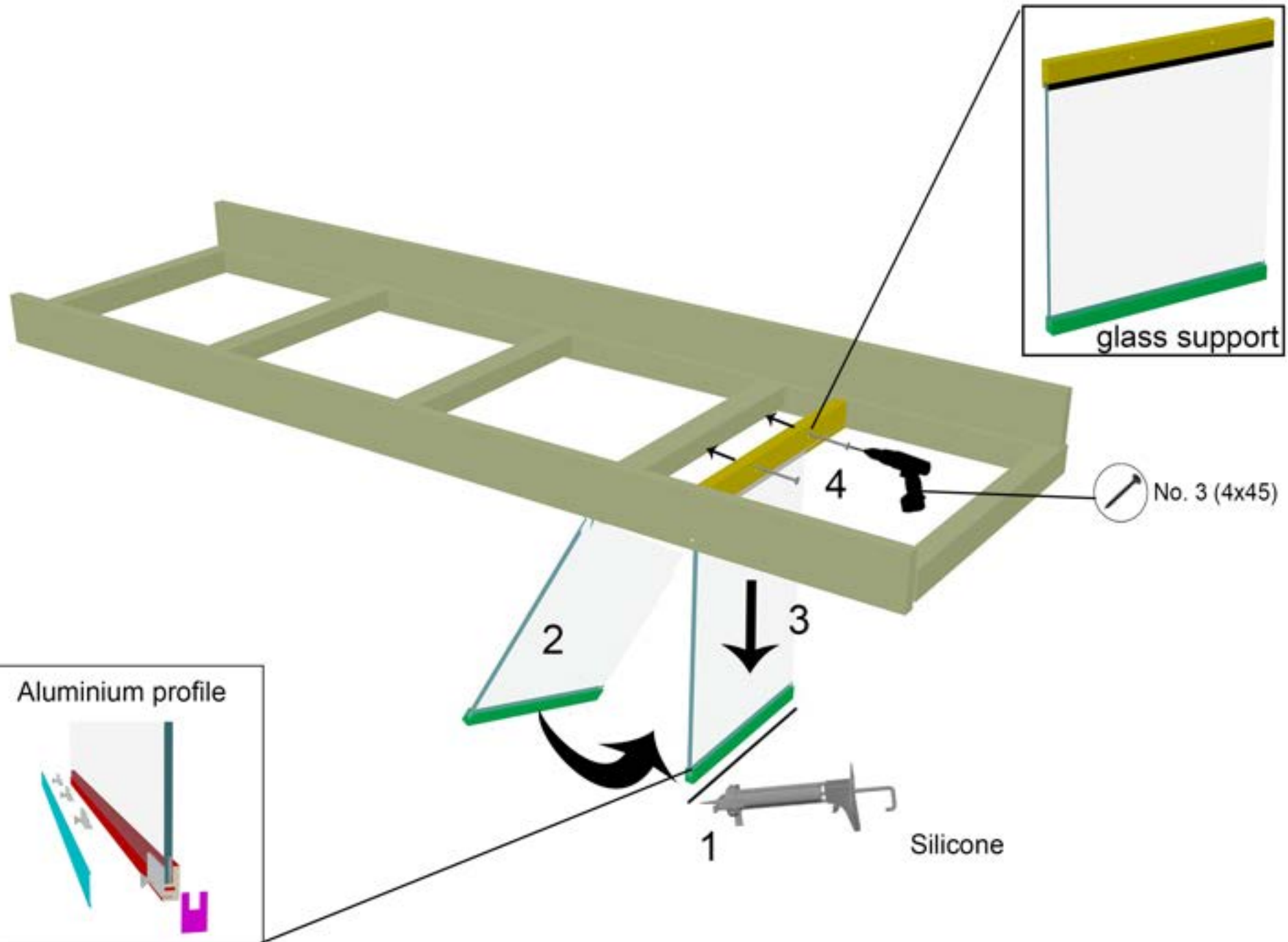

# 15. Interior II

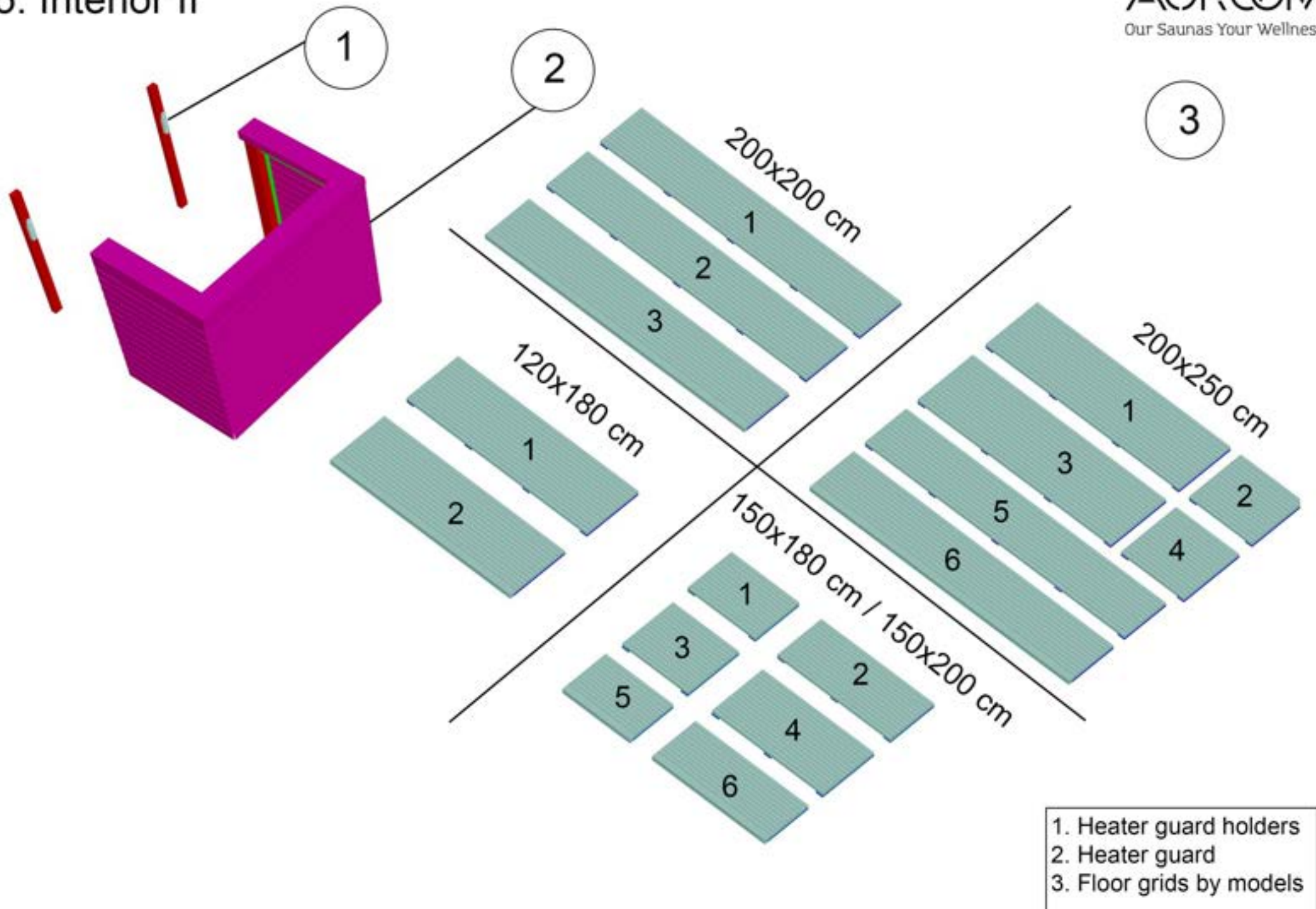

# 16. Heater guard

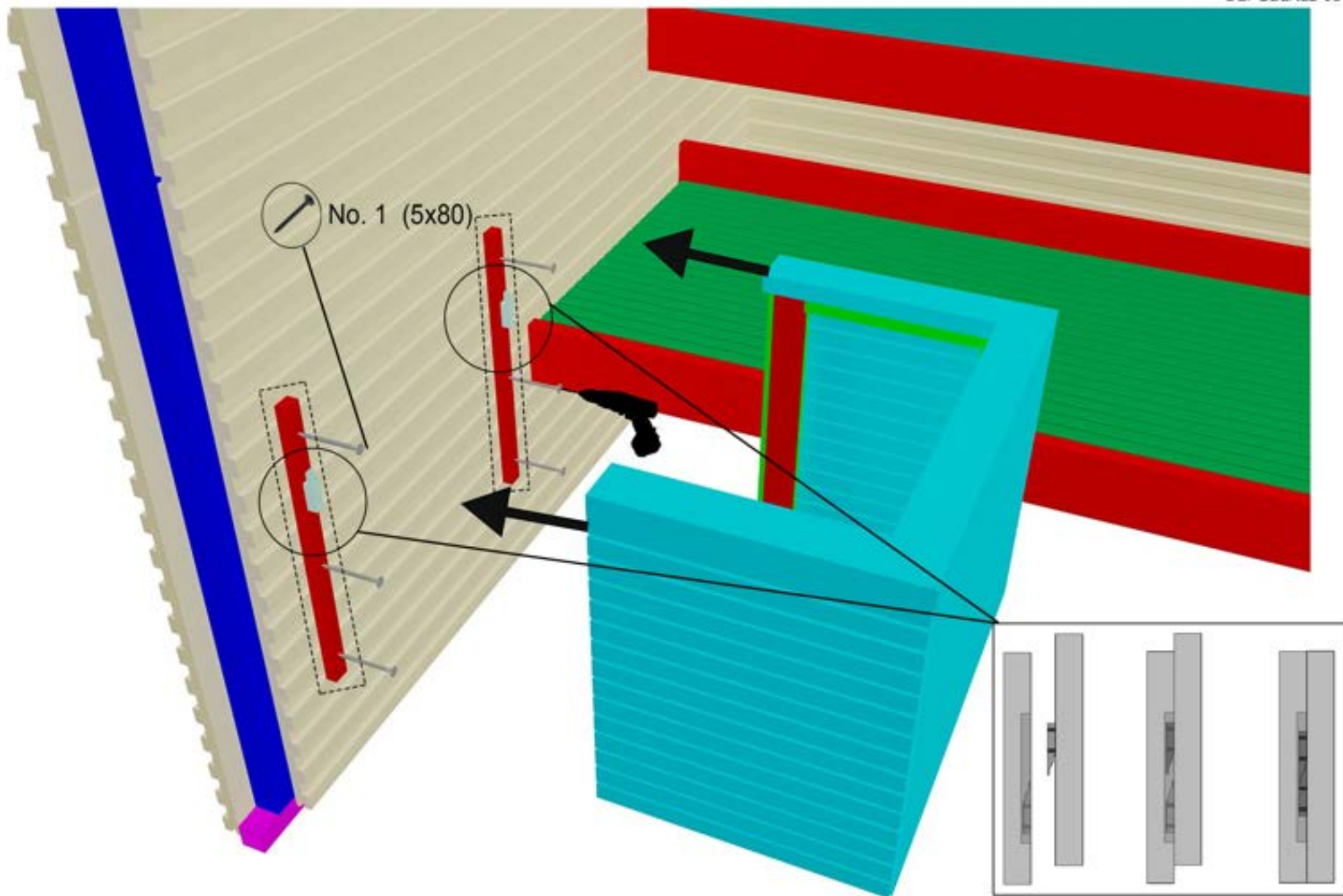

# 17. Door and glass wall

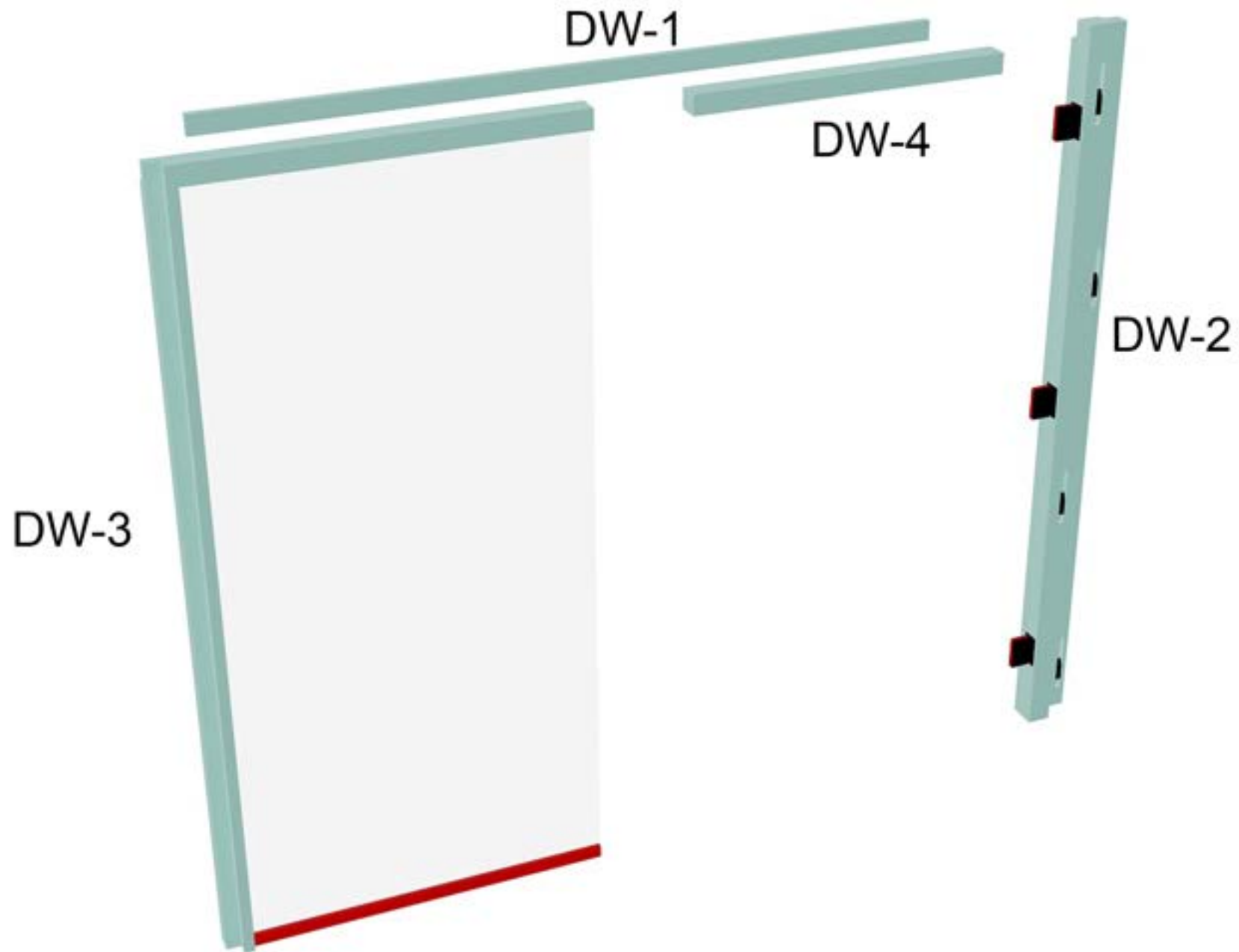



# 18. Fixing door & glass wall frame

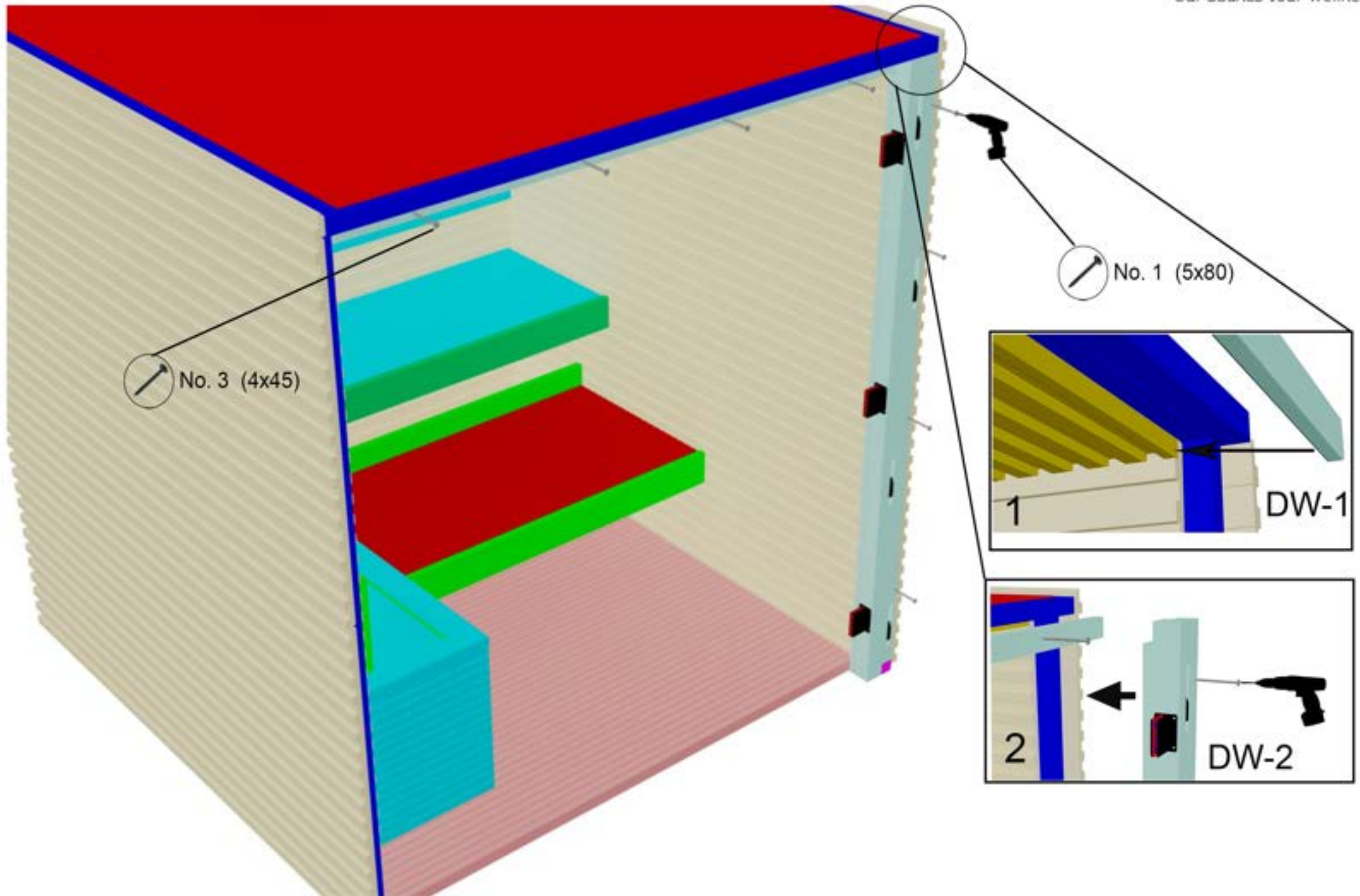

## 19. Aluminium profile fixing under glass wall

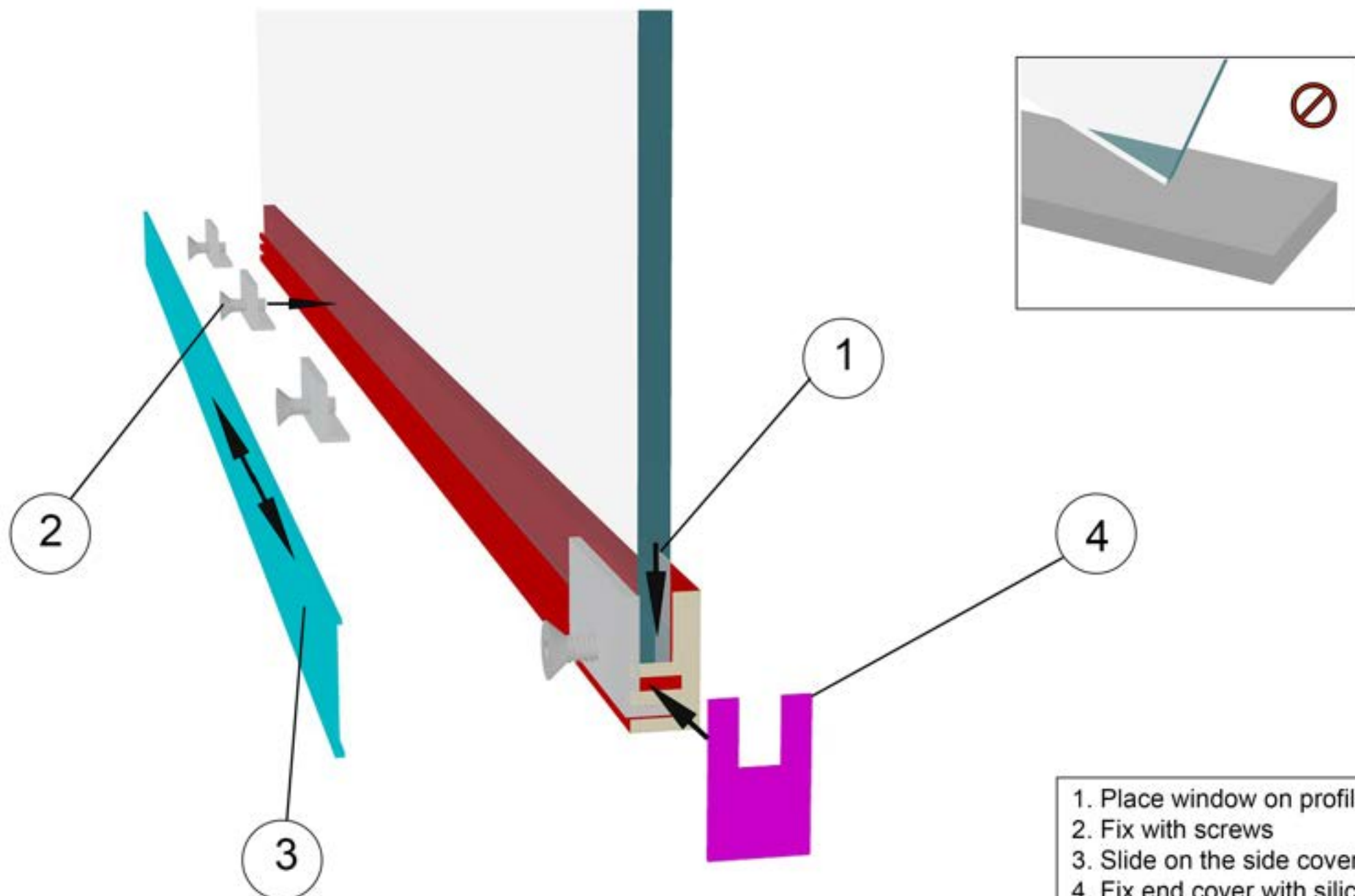

1. Place window on profile
2. Fix with screws
3. Slide on the side cover
4. Fix end cover with silicone

## 20. Fixing door & glass wall frame

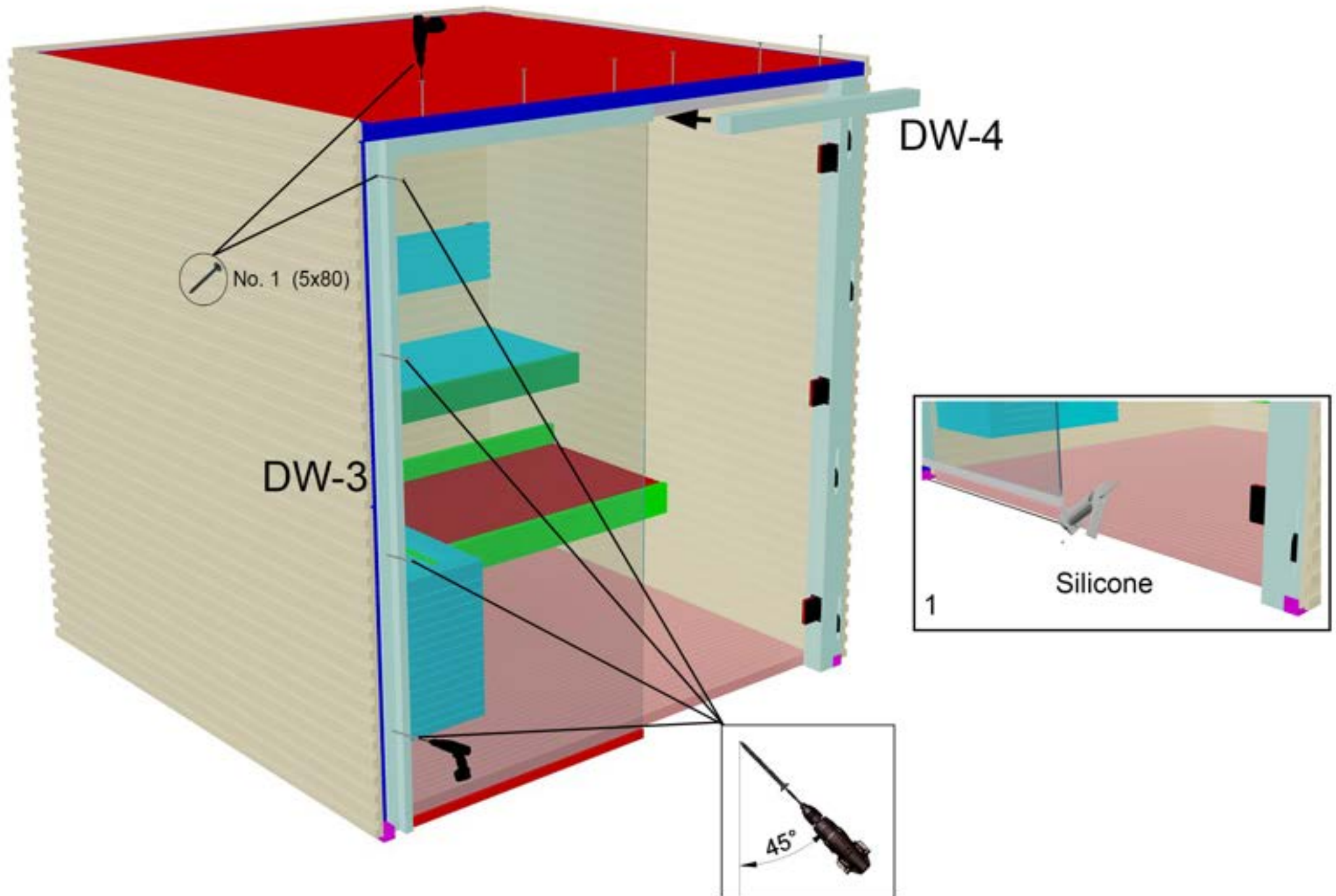

## 21. Adjusting glass wall

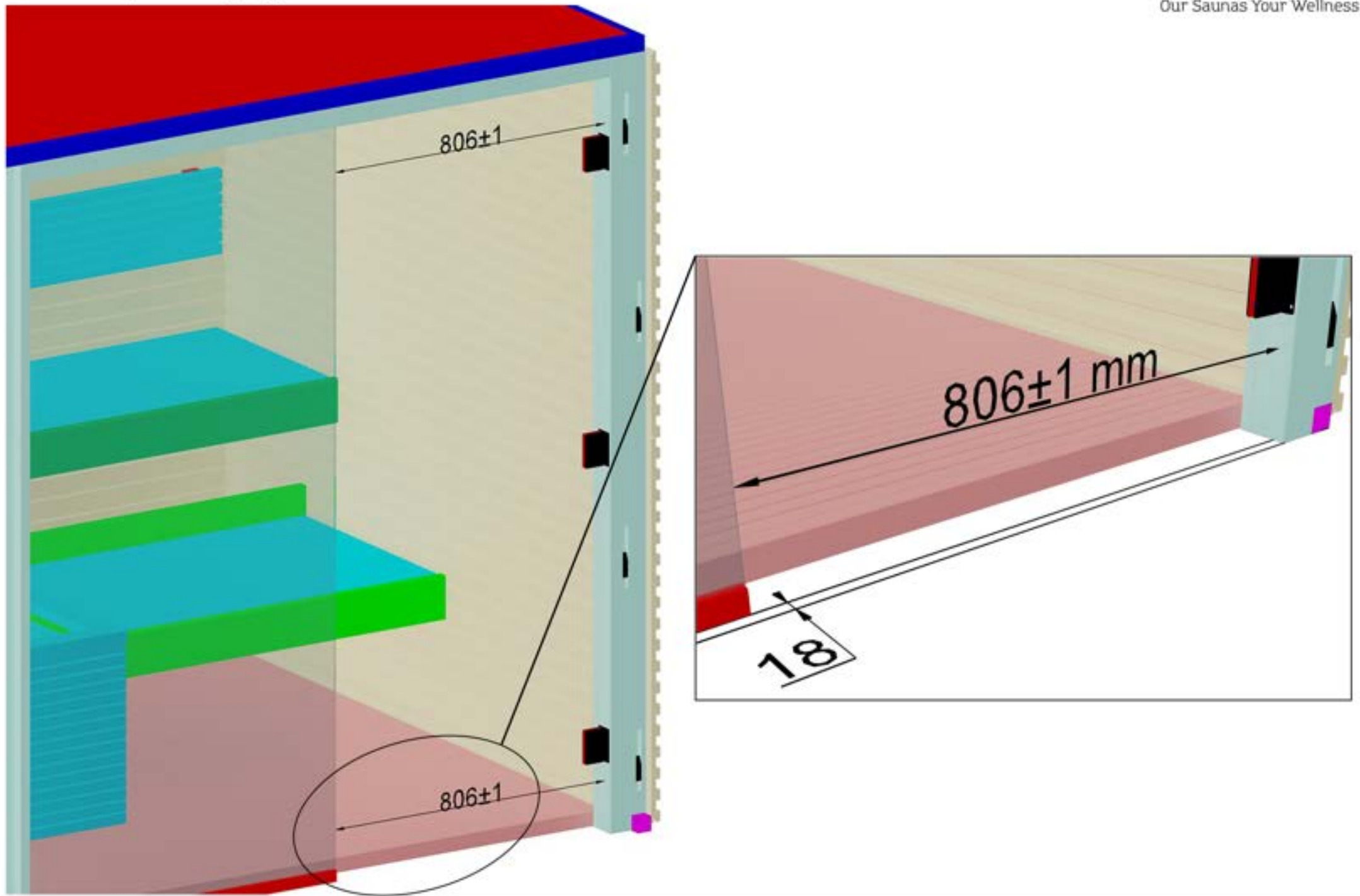

## 22. Fixing Detail 1

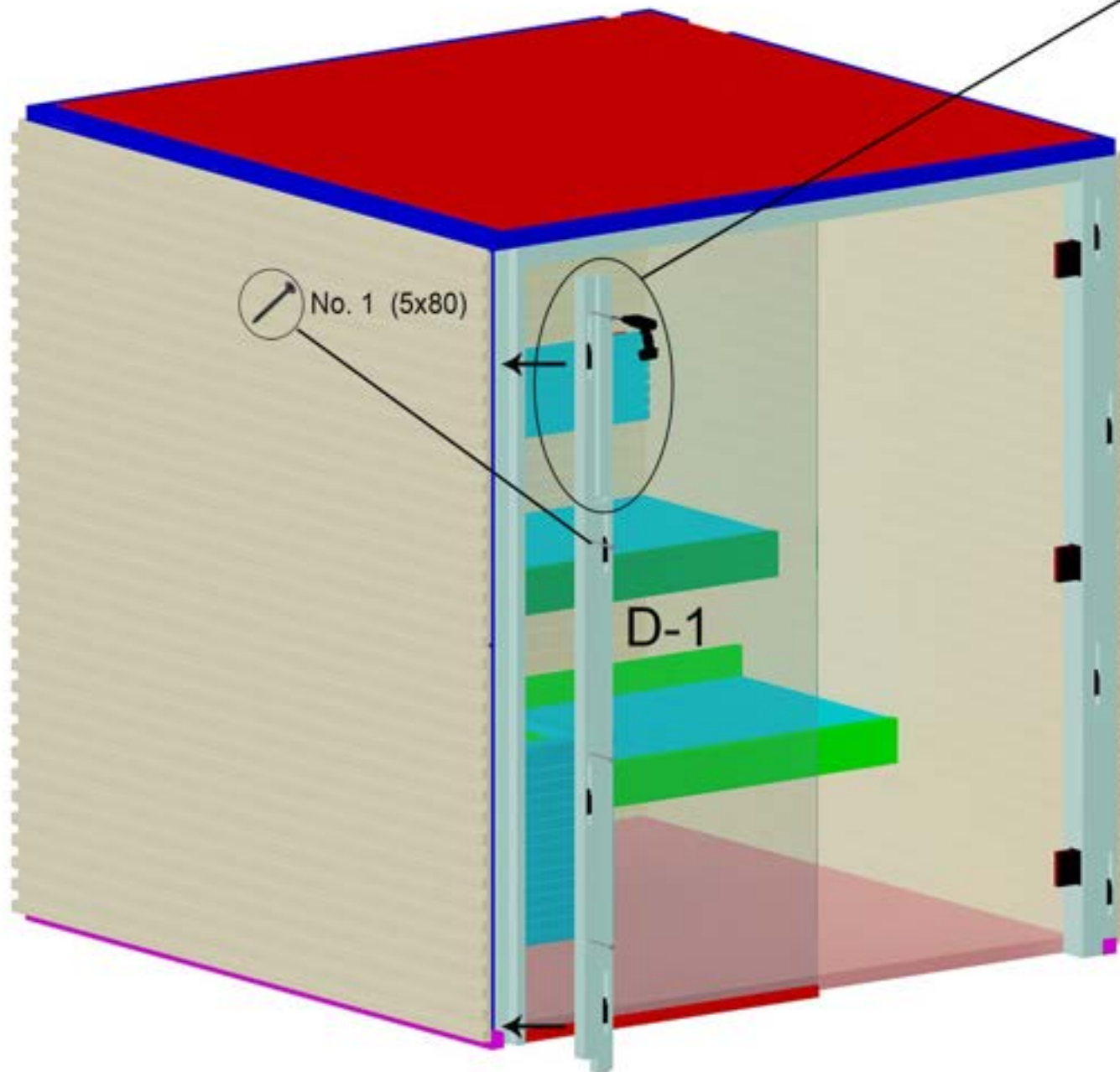

1

1. Cut out for control unit cable

# 23. Upper frame

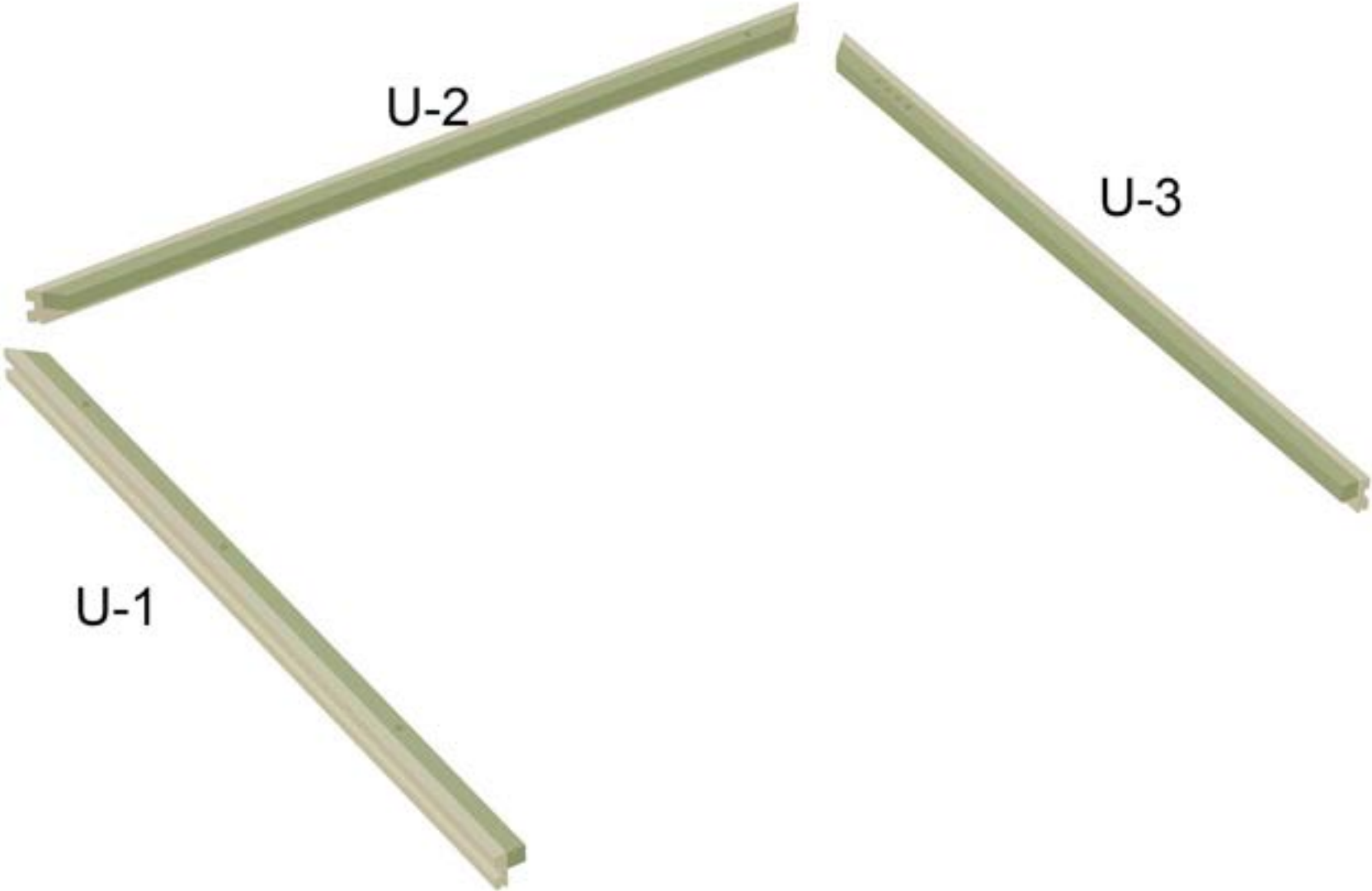

## 24. Fixing upper frame

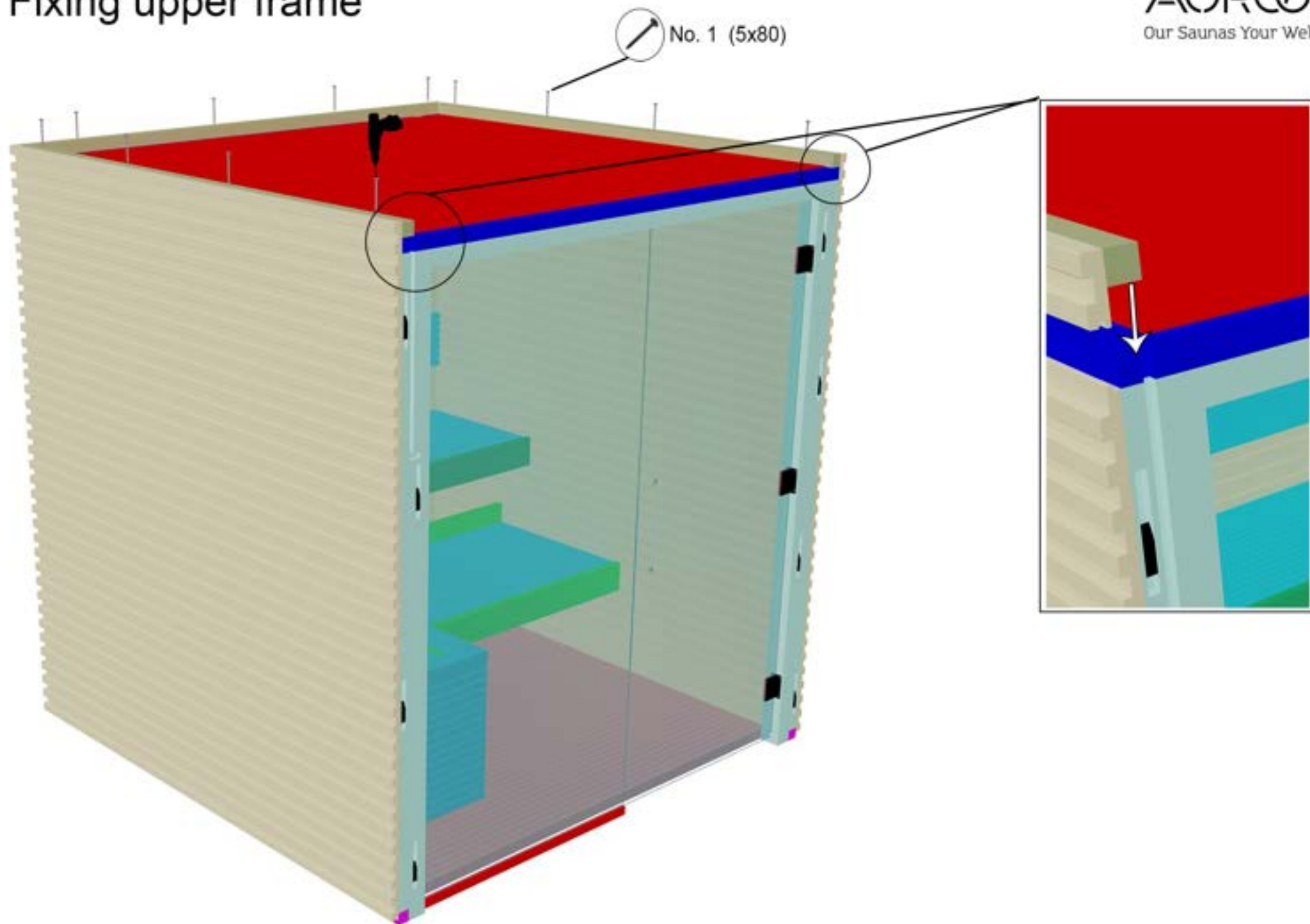

## 25. Door hinges and handle

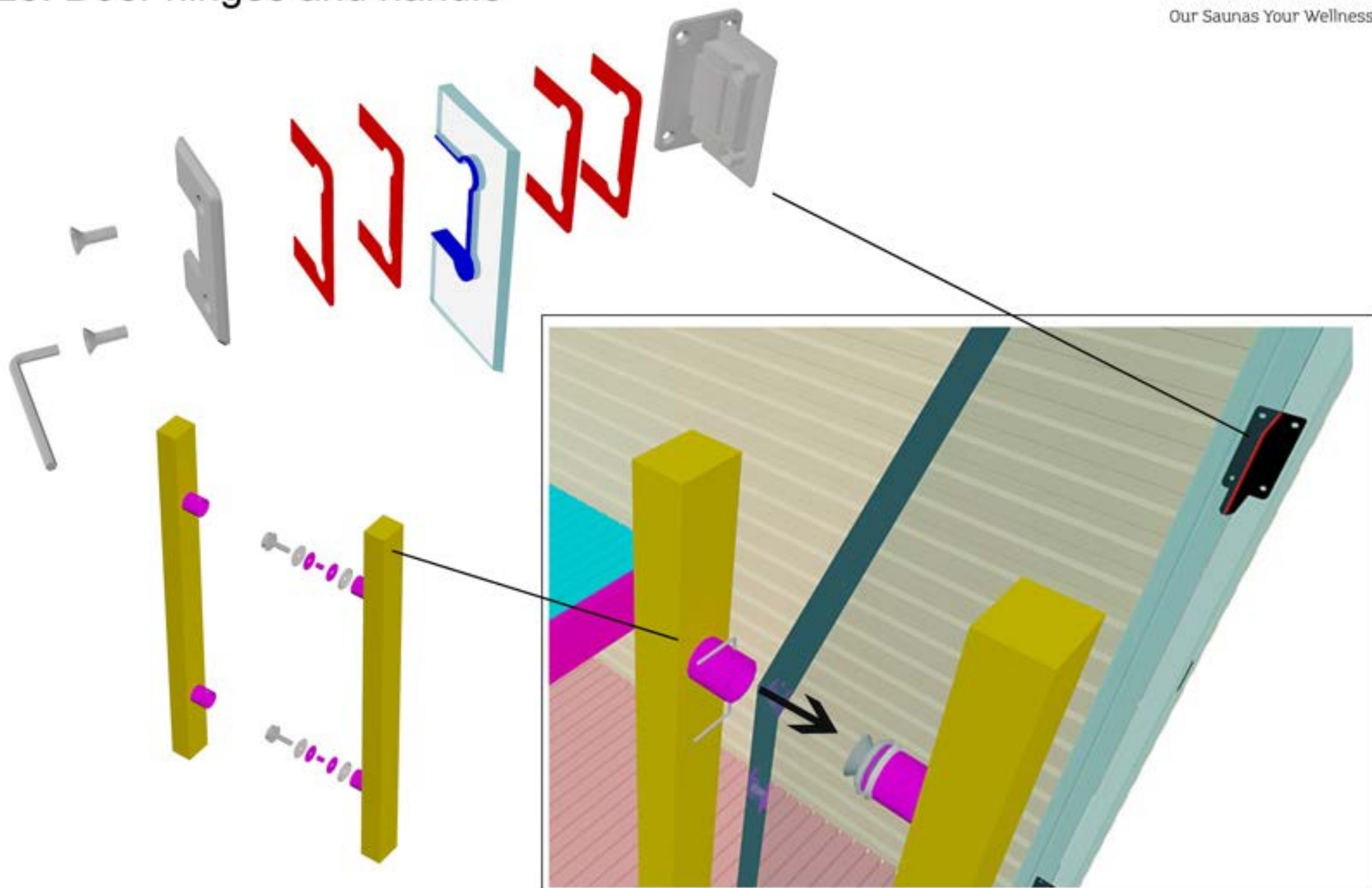



## 26. Control unit cable mounting

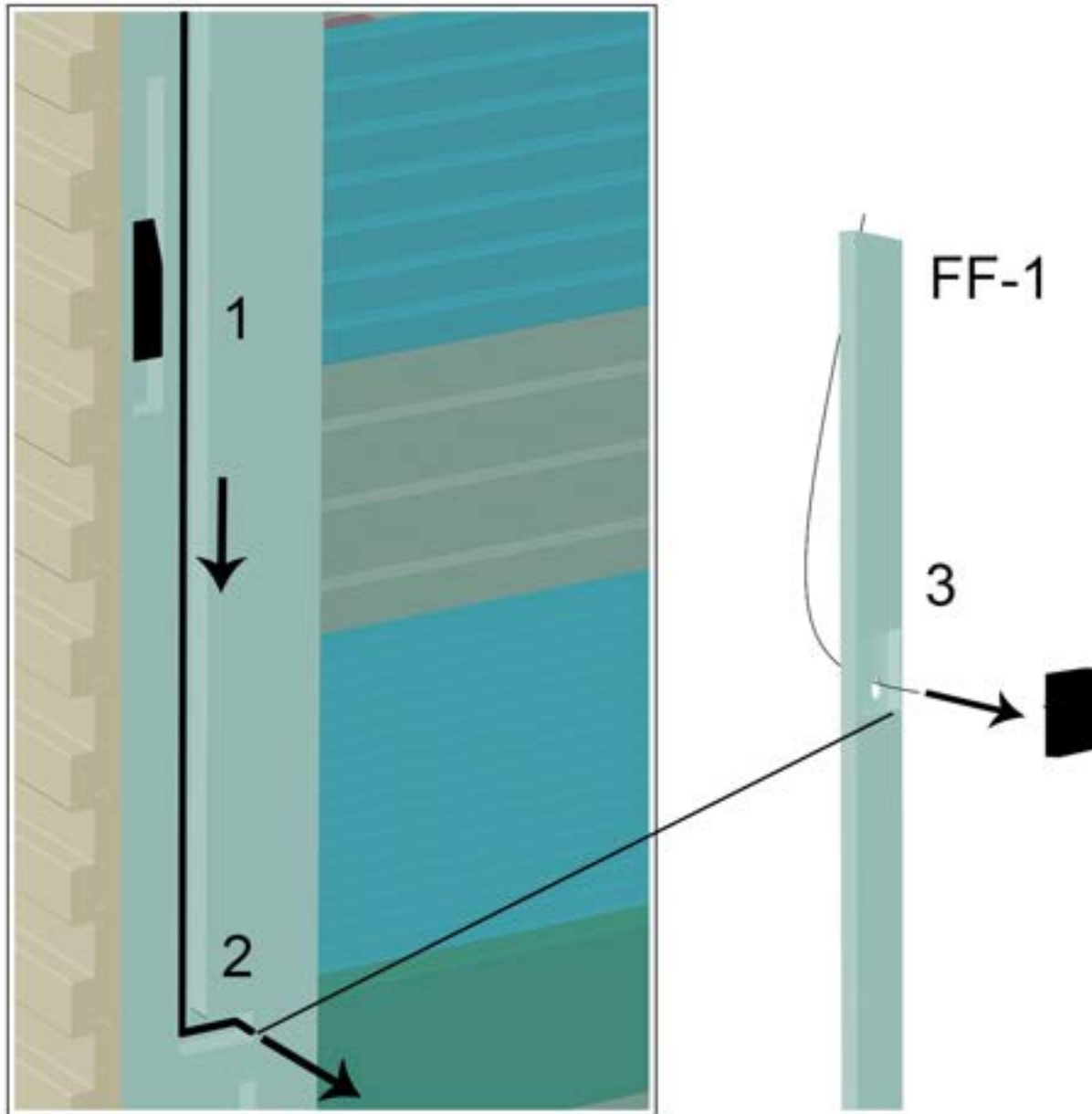

1. Put control unit cable inside (D-1) precut
2. Make sure cable stays in precut and install front frame detail (FF-1)
3. Pull out cable from hole in front frame

## 27. Front frame

FF-1



FF-2

FF-3

## 28. Fixing front frame

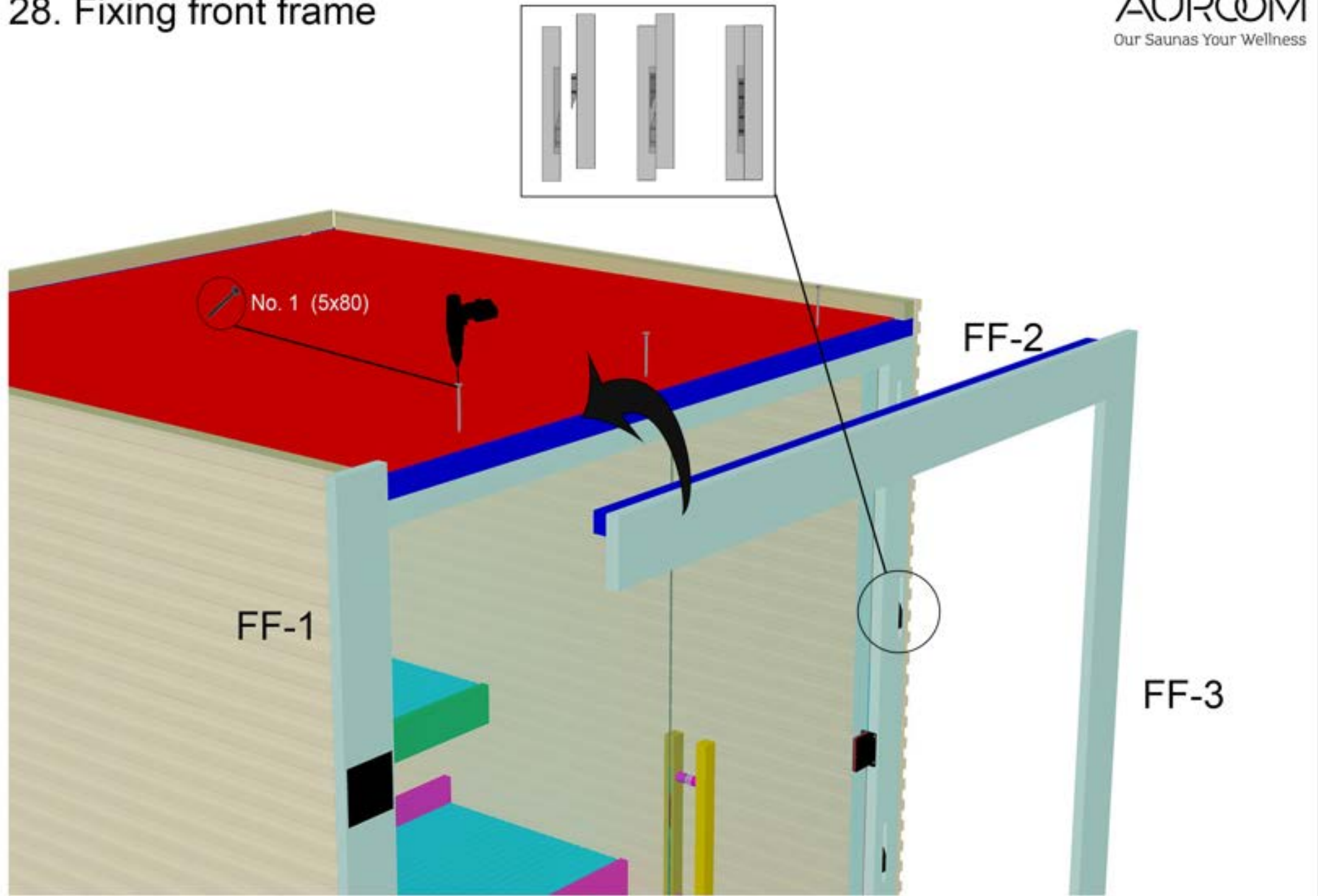

## 29. Wiring on ceiling

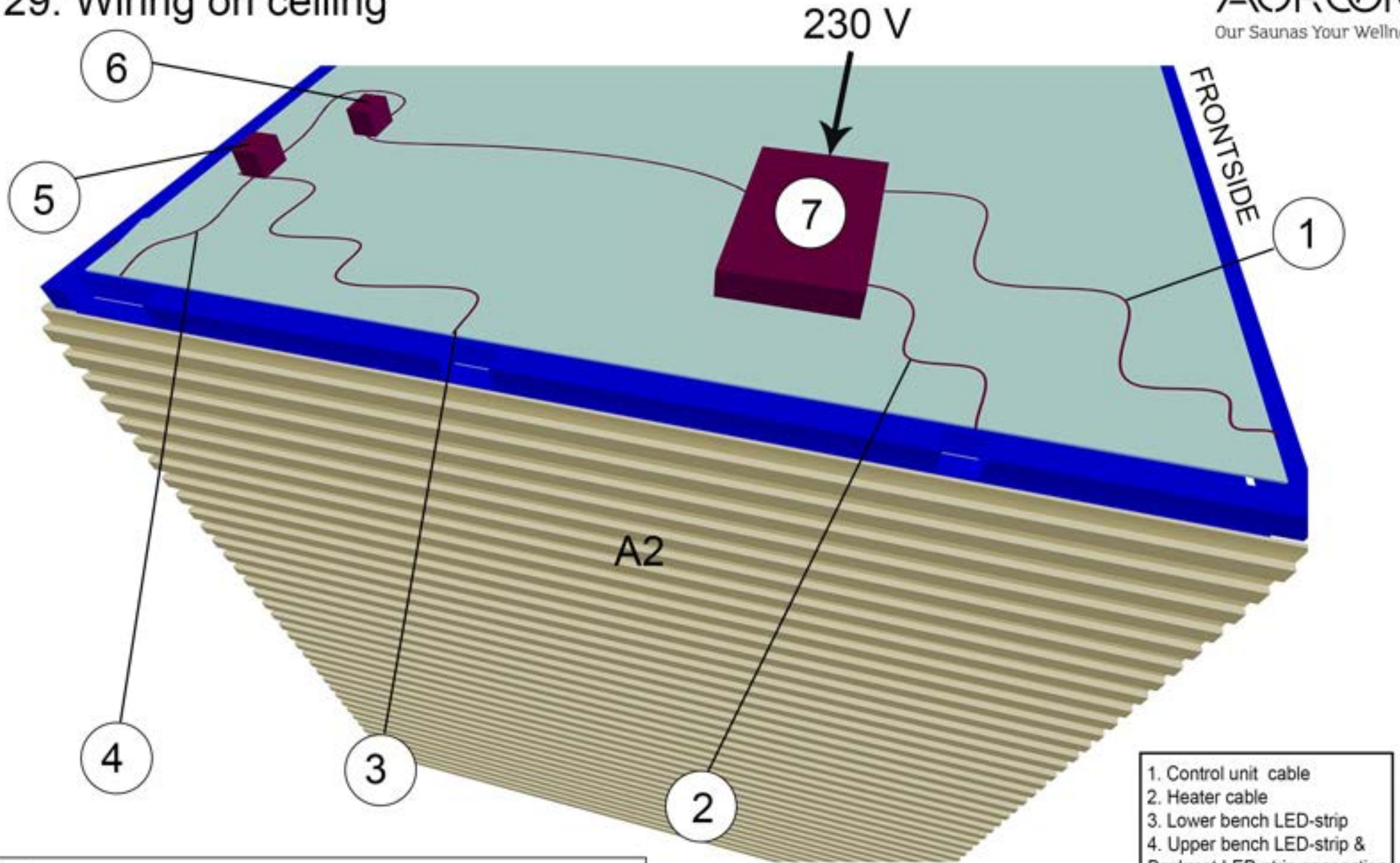

**!** Always use a certified electrician