

NATIVA

Installation manual

Dimensions:

120x180 cm

150x180 cm

150x200 cm

200x200 cm

200x250 cm

Handedness:

Left



Leave space for better assembly

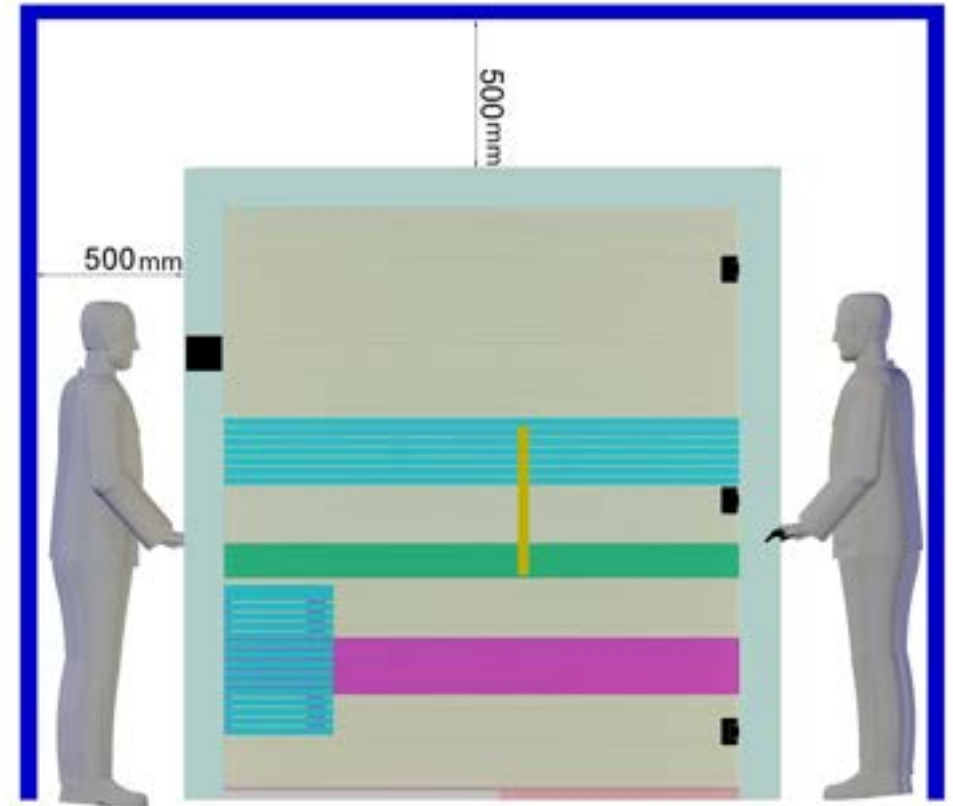
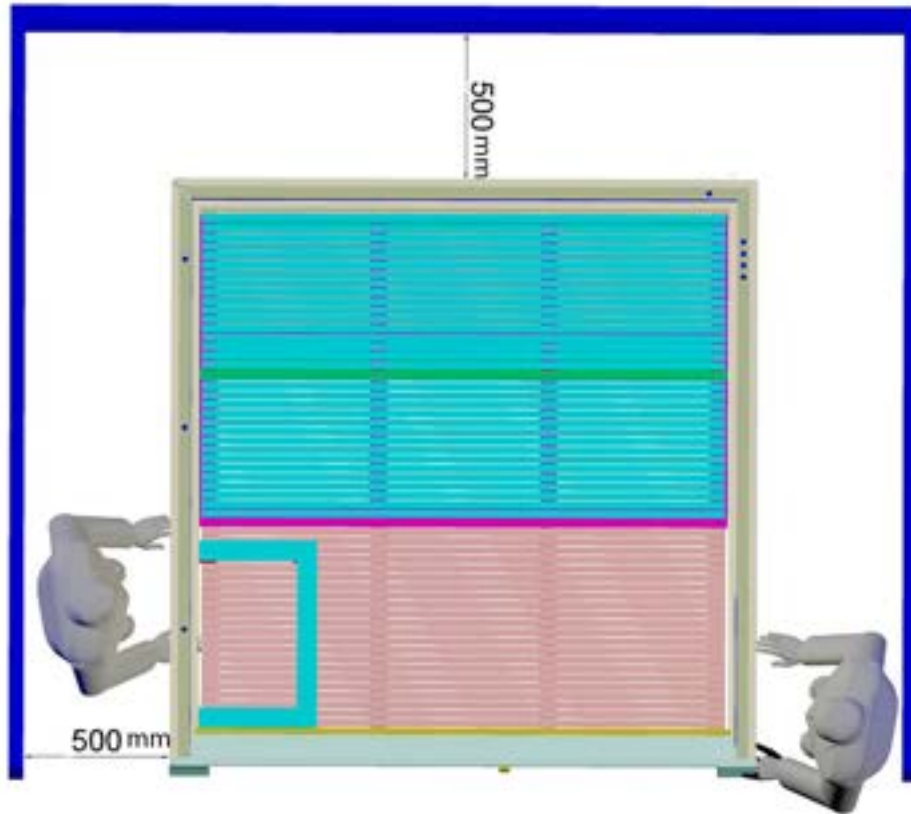

Tools



1. Base frame

	x (mm)	y (mm)
120x180 cm	2088	1746
150x180 cm	2267	1746
150x200 cm	2424	1946
200x200 cm	2752	1946
200x250 cm	3126	2446

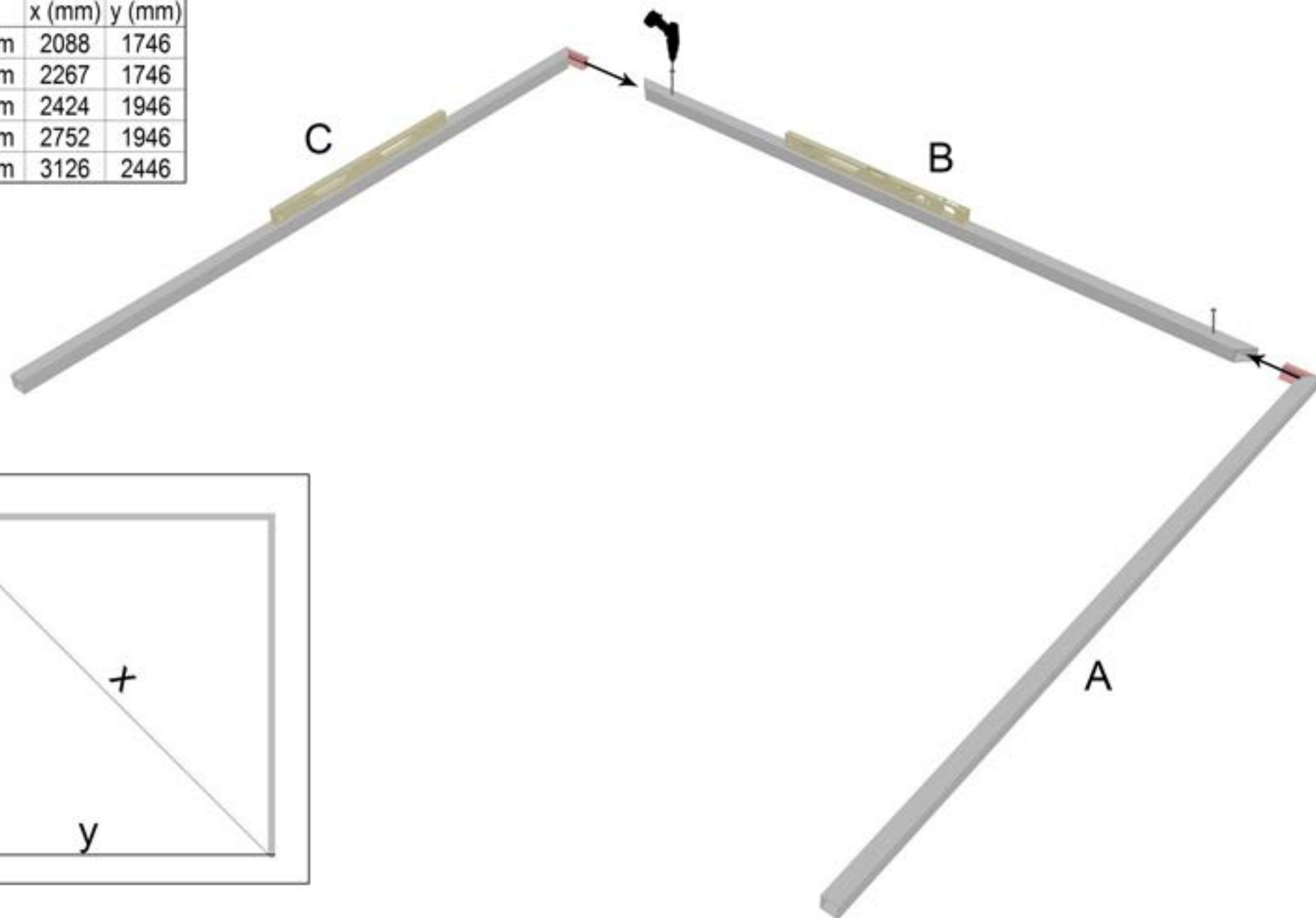

2. Walls

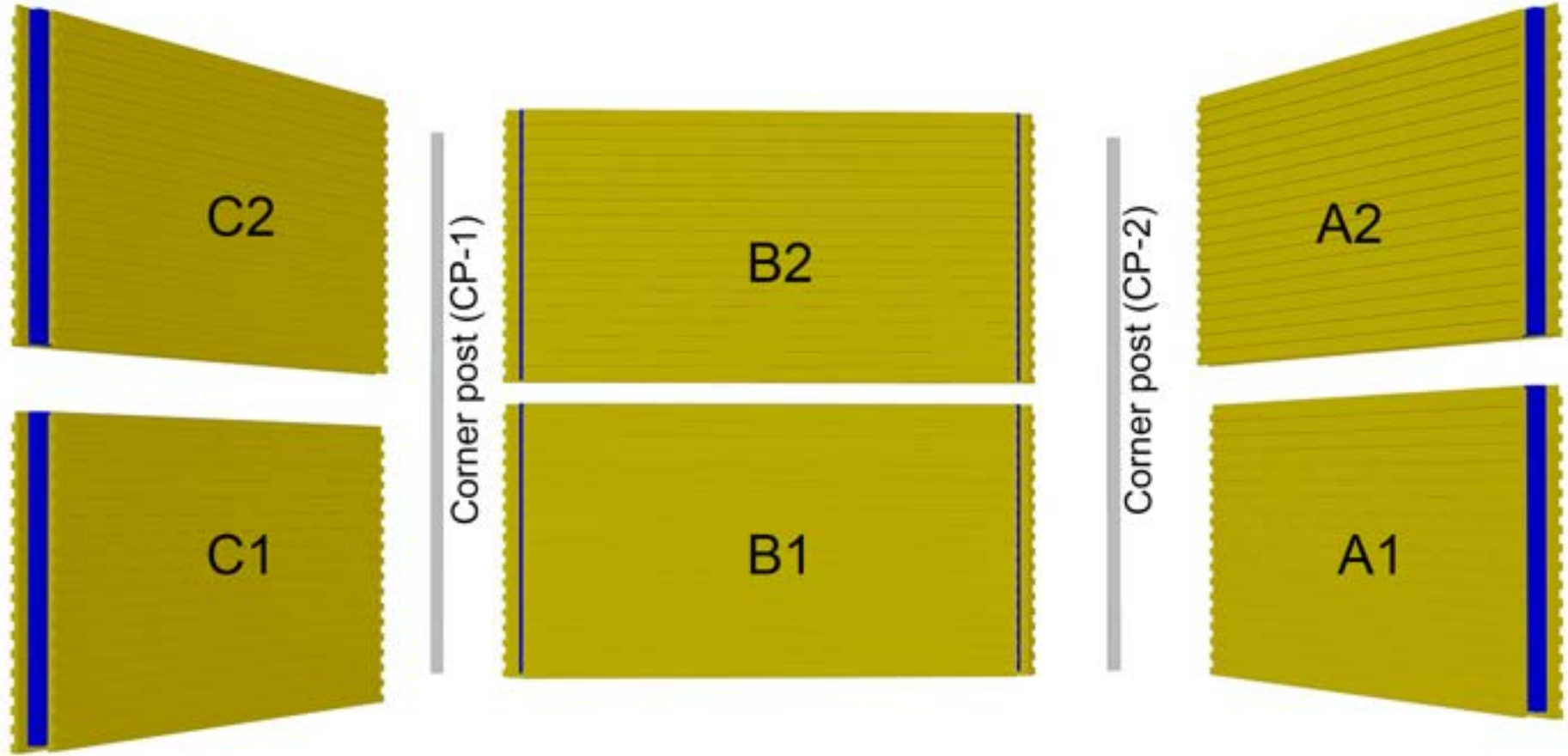

3. Multiclip closing system

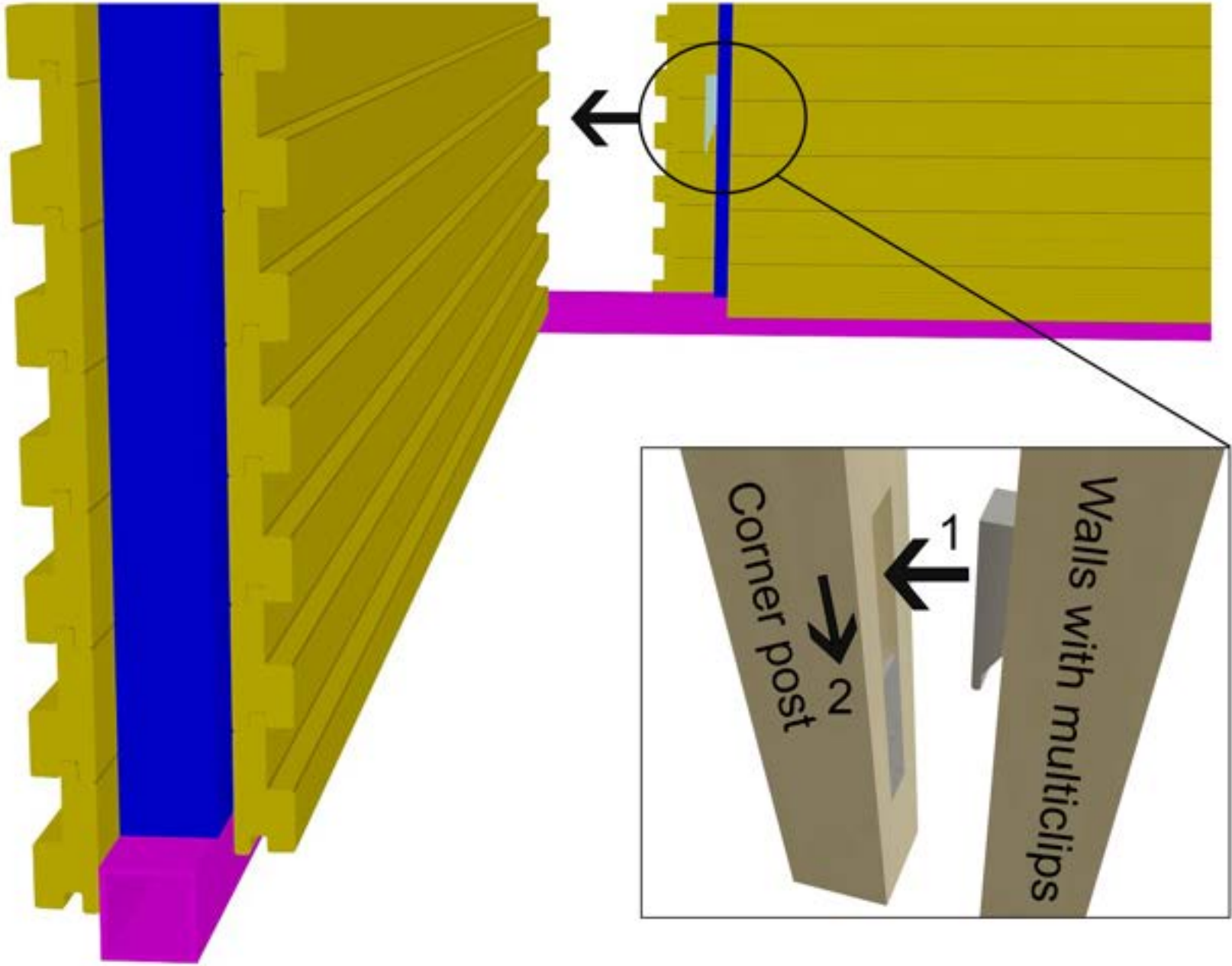

4. Fixing walls A1 & B1

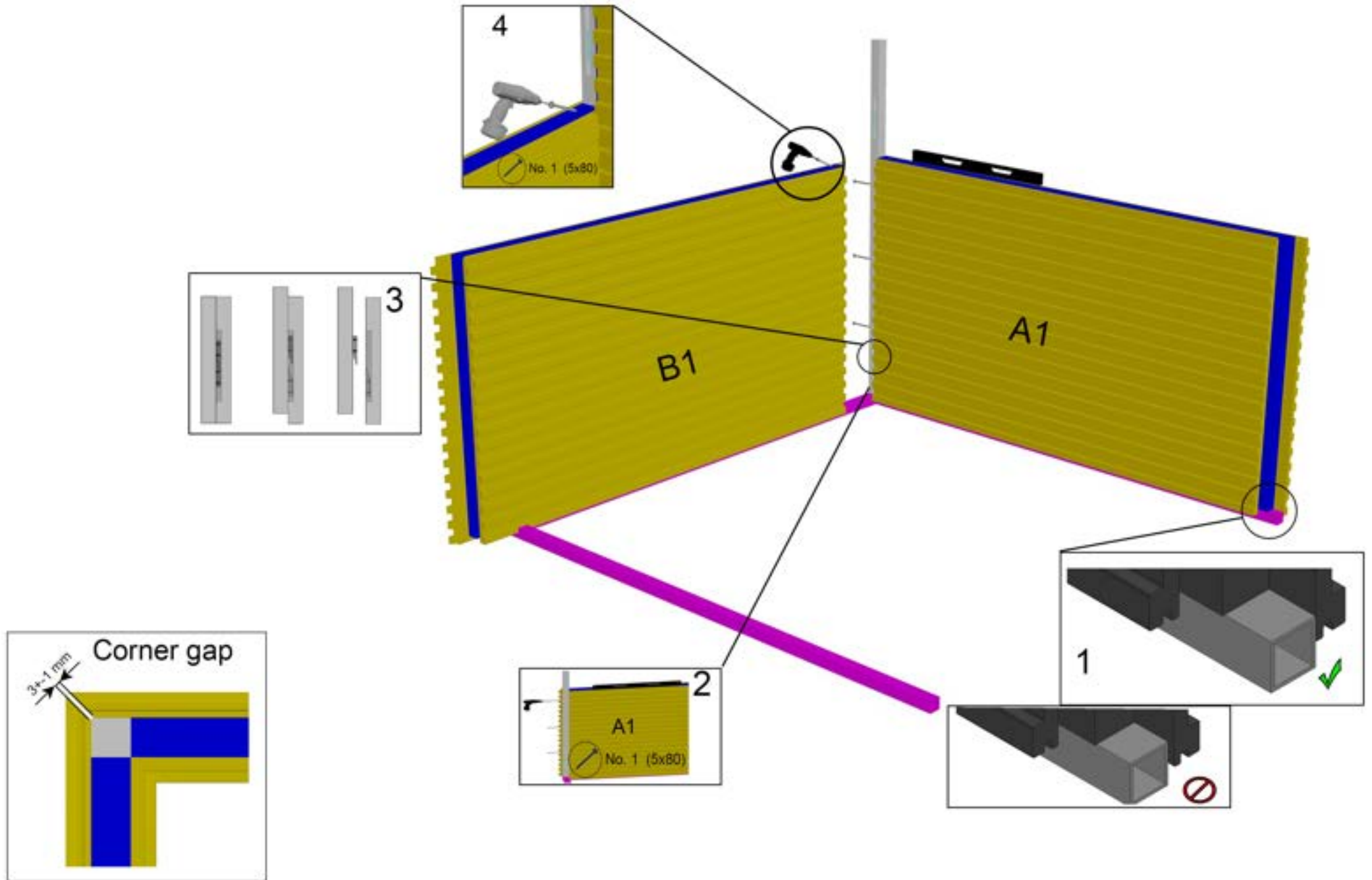

5. Fixing walls A2 & B2

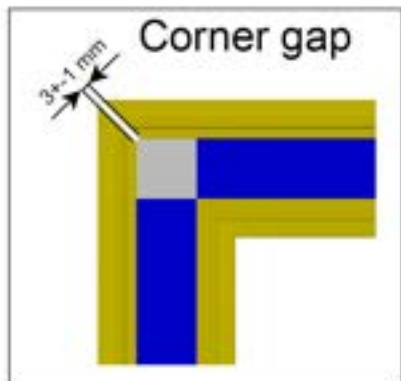
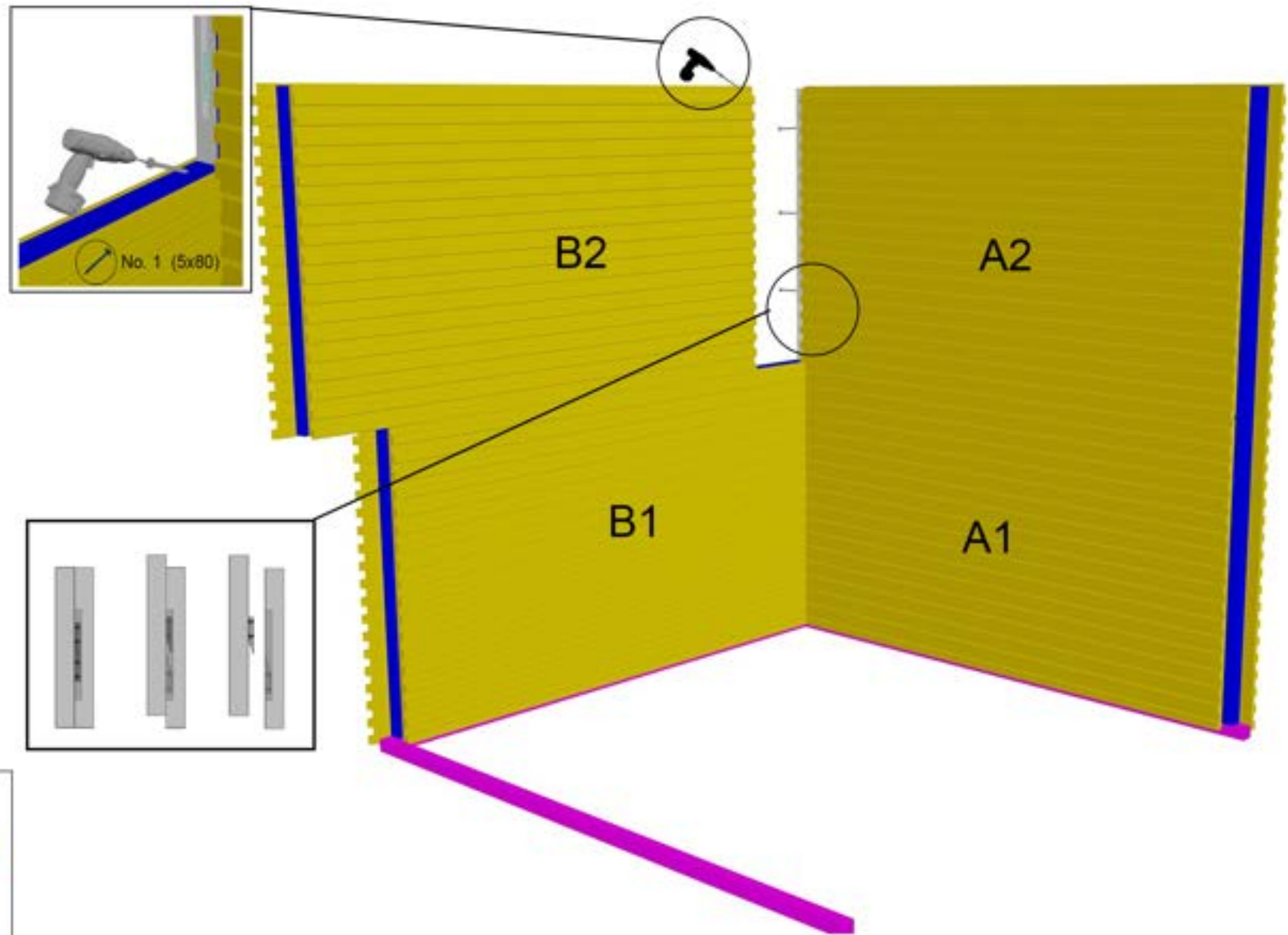

6. Fixing walls C1 & C2

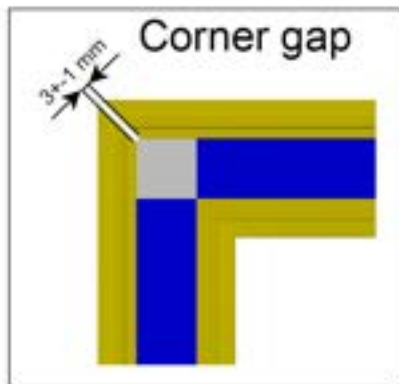
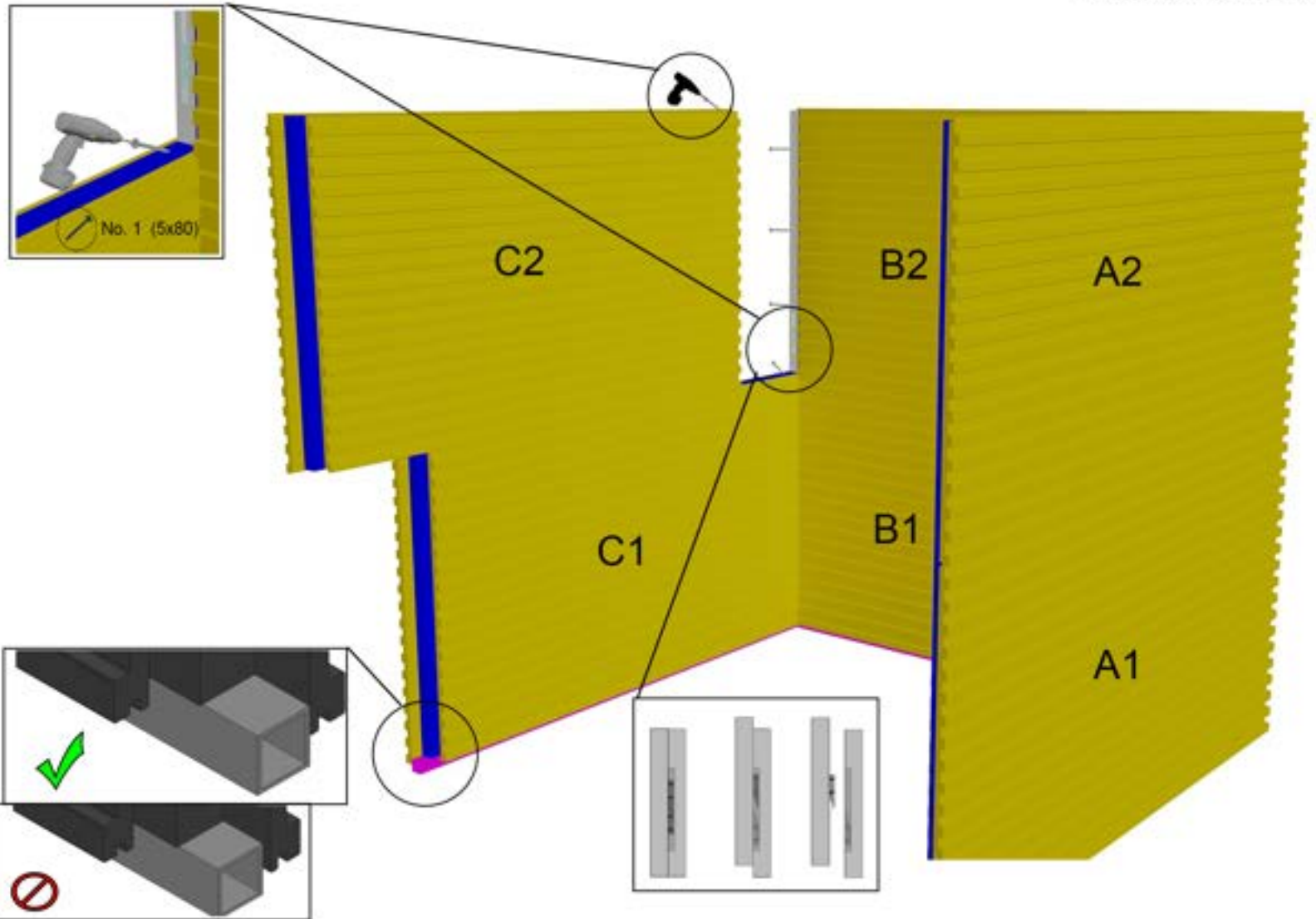

7. Fixing ceilings

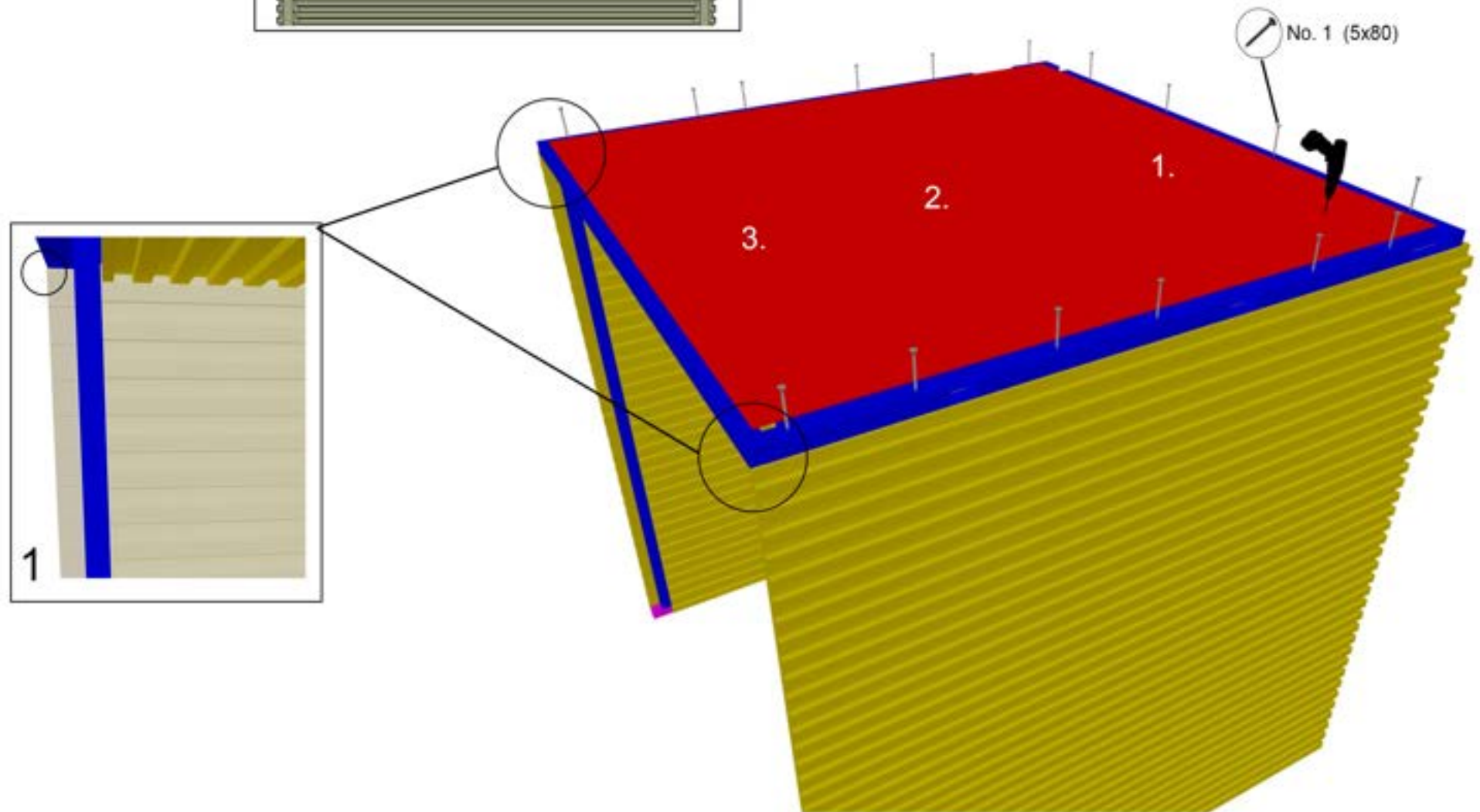
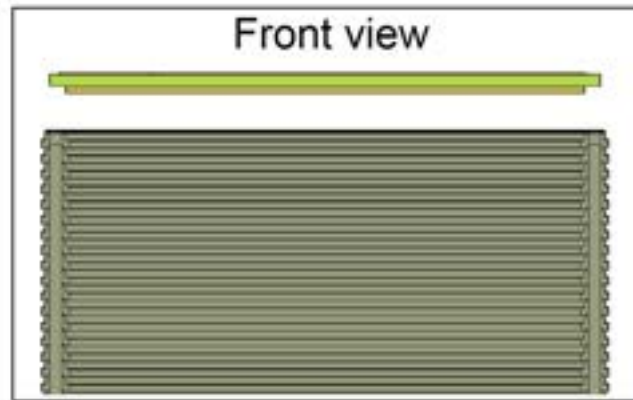

8. Interior 200x200 cm

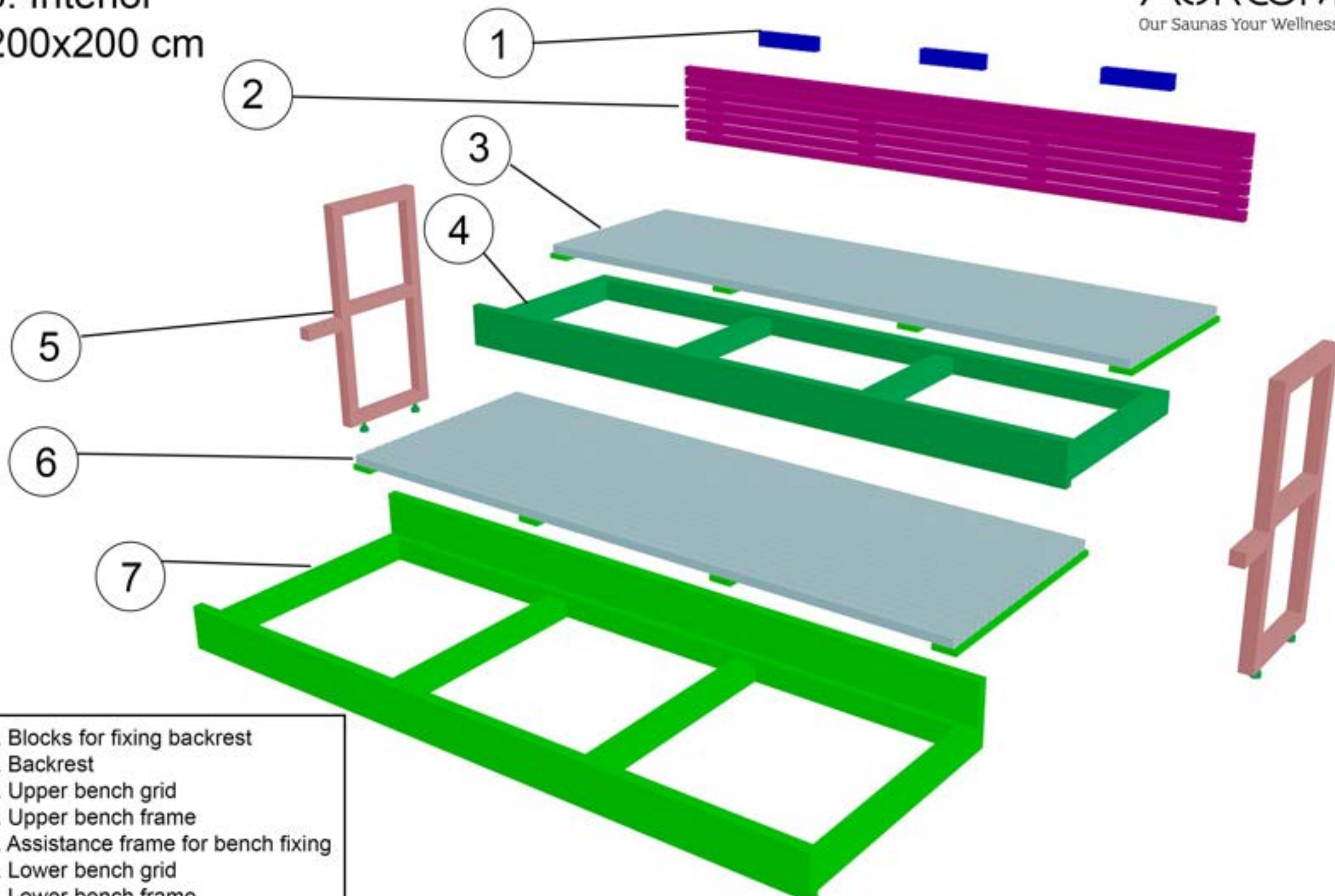

1. Blocks for fixing backrest
2. Backrest
3. Upper bench grid
4. Upper bench frame
5. Assistance frame for bench fixing
6. Lower bench grid
7. Lower bench frame

8.1 Interior 120x180 cm

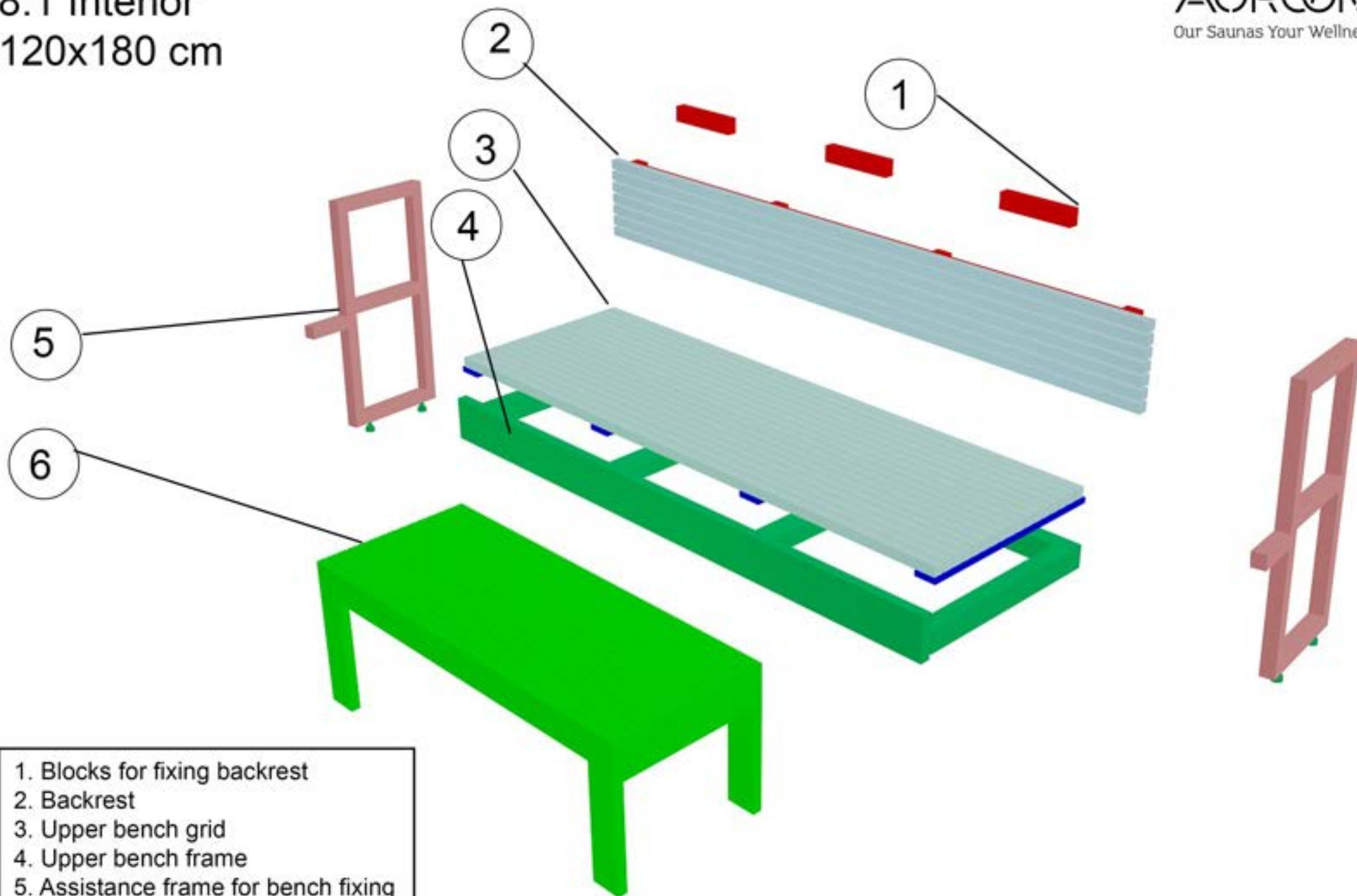

1. Blocks for fixing backrest
2. Backrest
3. Upper bench grid
4. Upper bench frame
5. Assistance frame for bench fixing
6. Lower bench

8.2 Interior
150x180 cm
150x200 cm

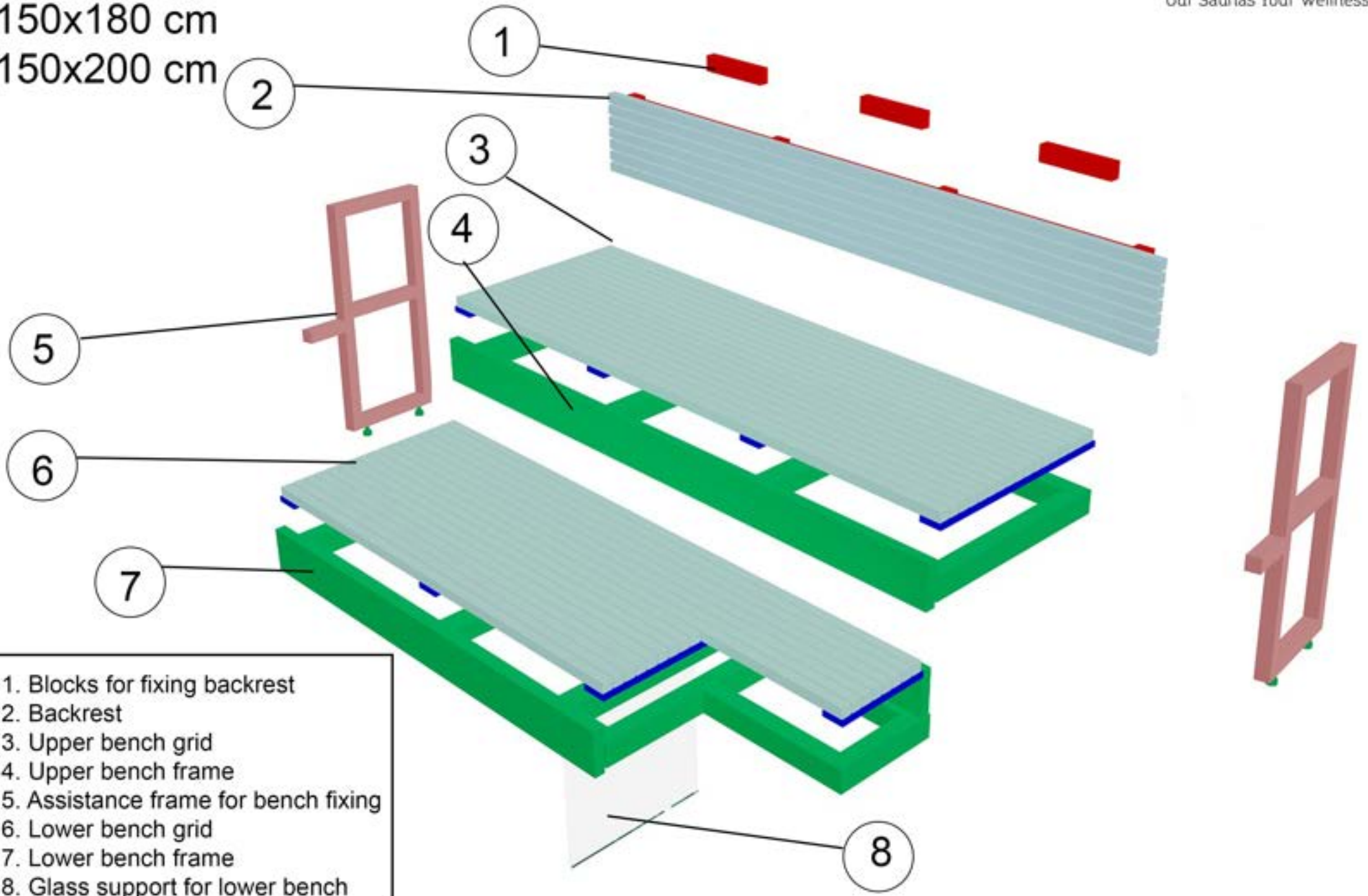

- 1. Blocks for fixing backrest
- 2. Backrest
- 3. Upper bench grid
- 4. Upper bench frame
- 5. Assistance frame for bench fixing
- 6. Lower bench grid
- 7. Lower bench frame
- 8. Glass support for lower bench

8.3 Interior 200x250 cm

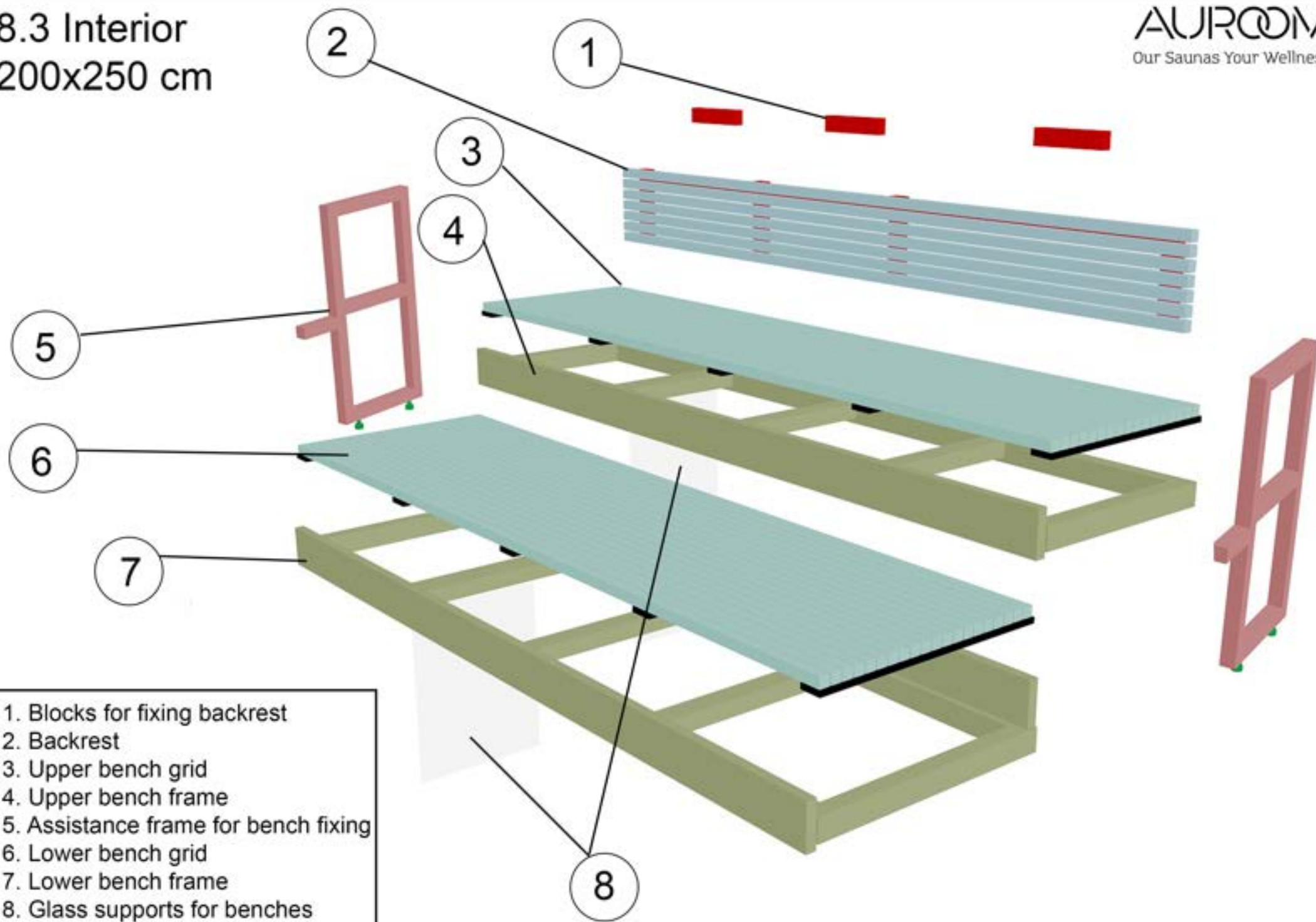

1. Blocks for fixing backrest
2. Backrest
3. Upper bench grid
4. Upper bench frame
5. Assistance frame for bench fixing
6. Lower bench grid
7. Lower bench frame
8. Glass supports for benches

9. Assistance frames

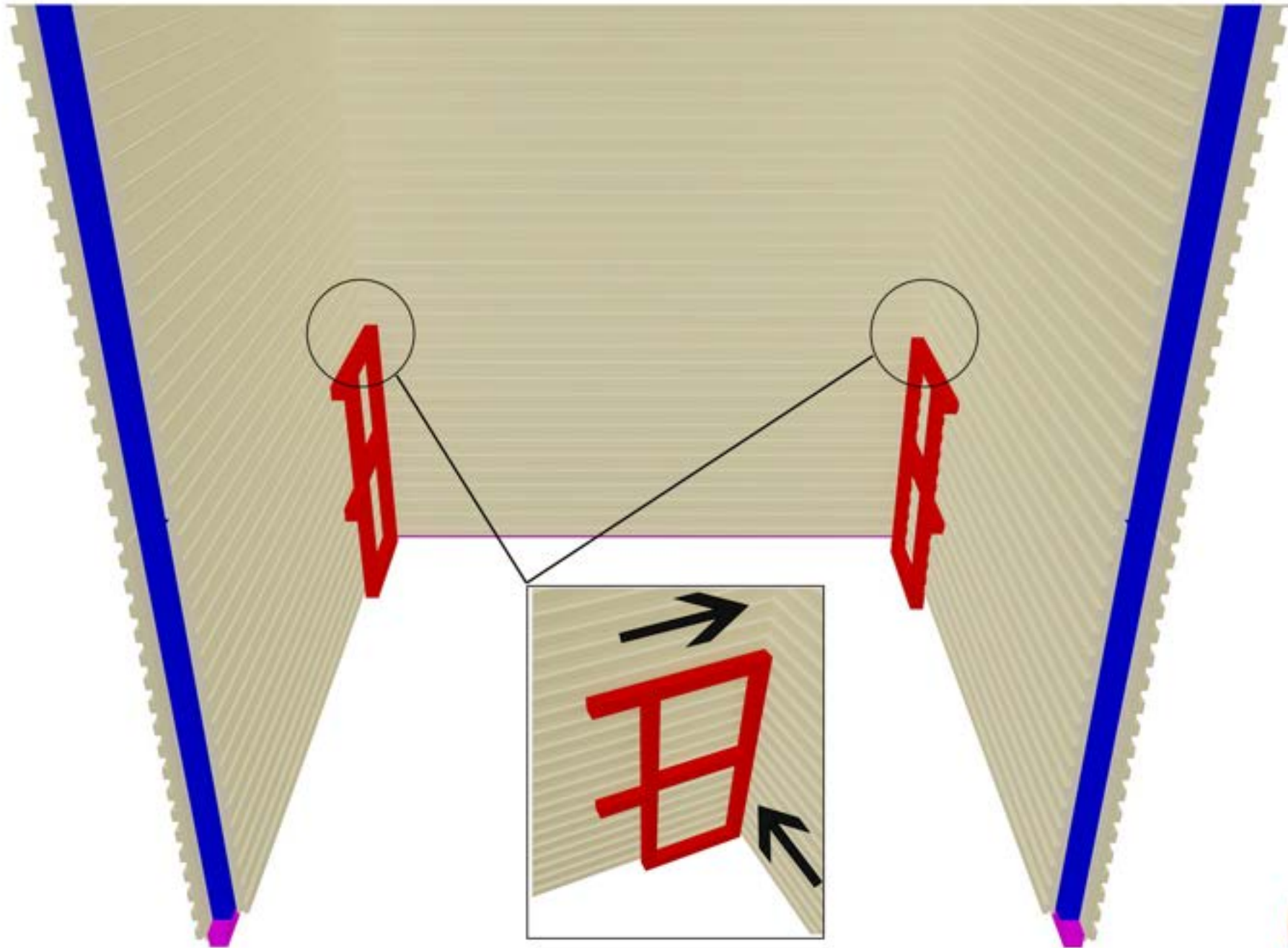

10. Bench frames and backrest blocks

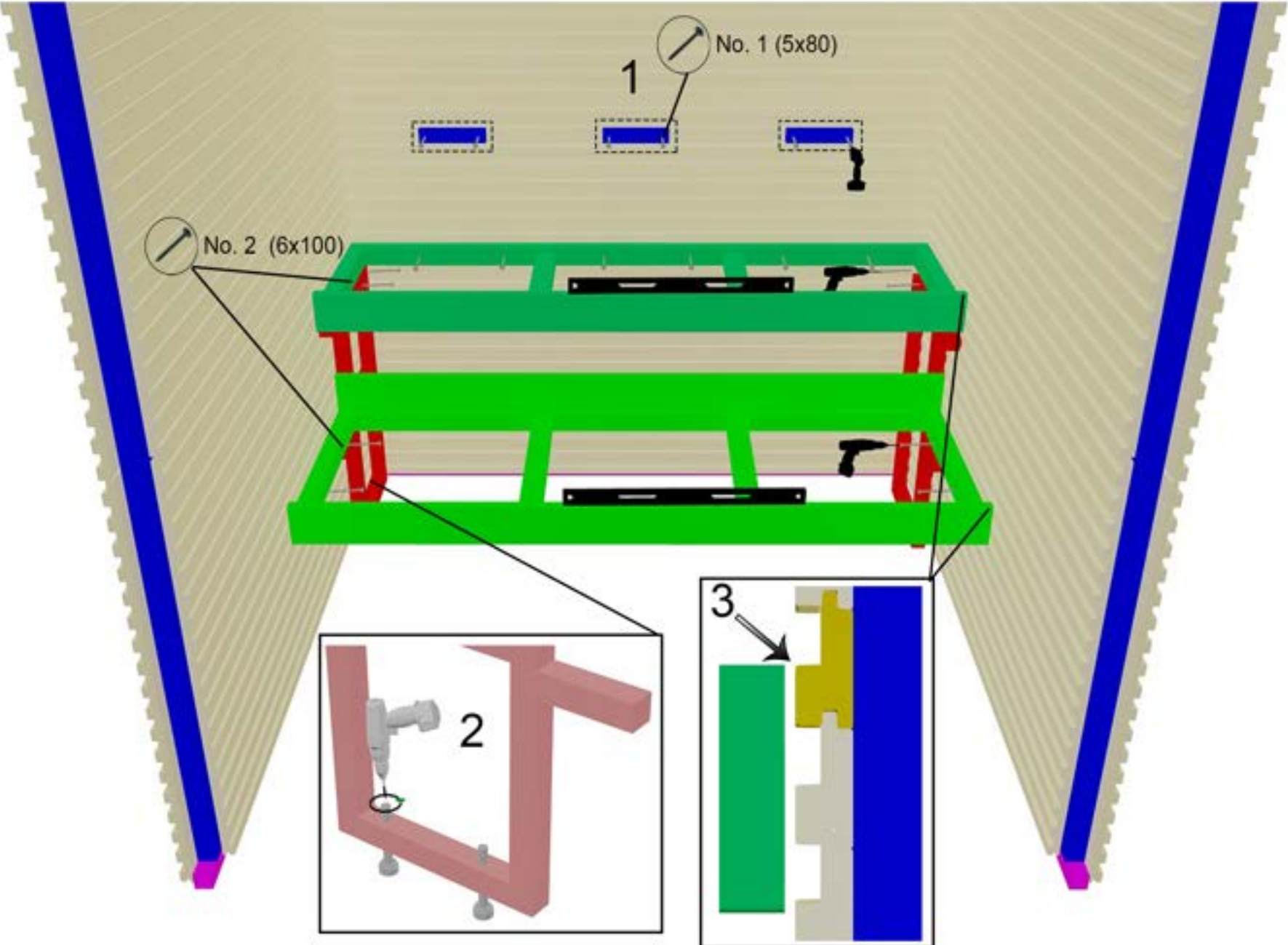

11. Removing assistance frames

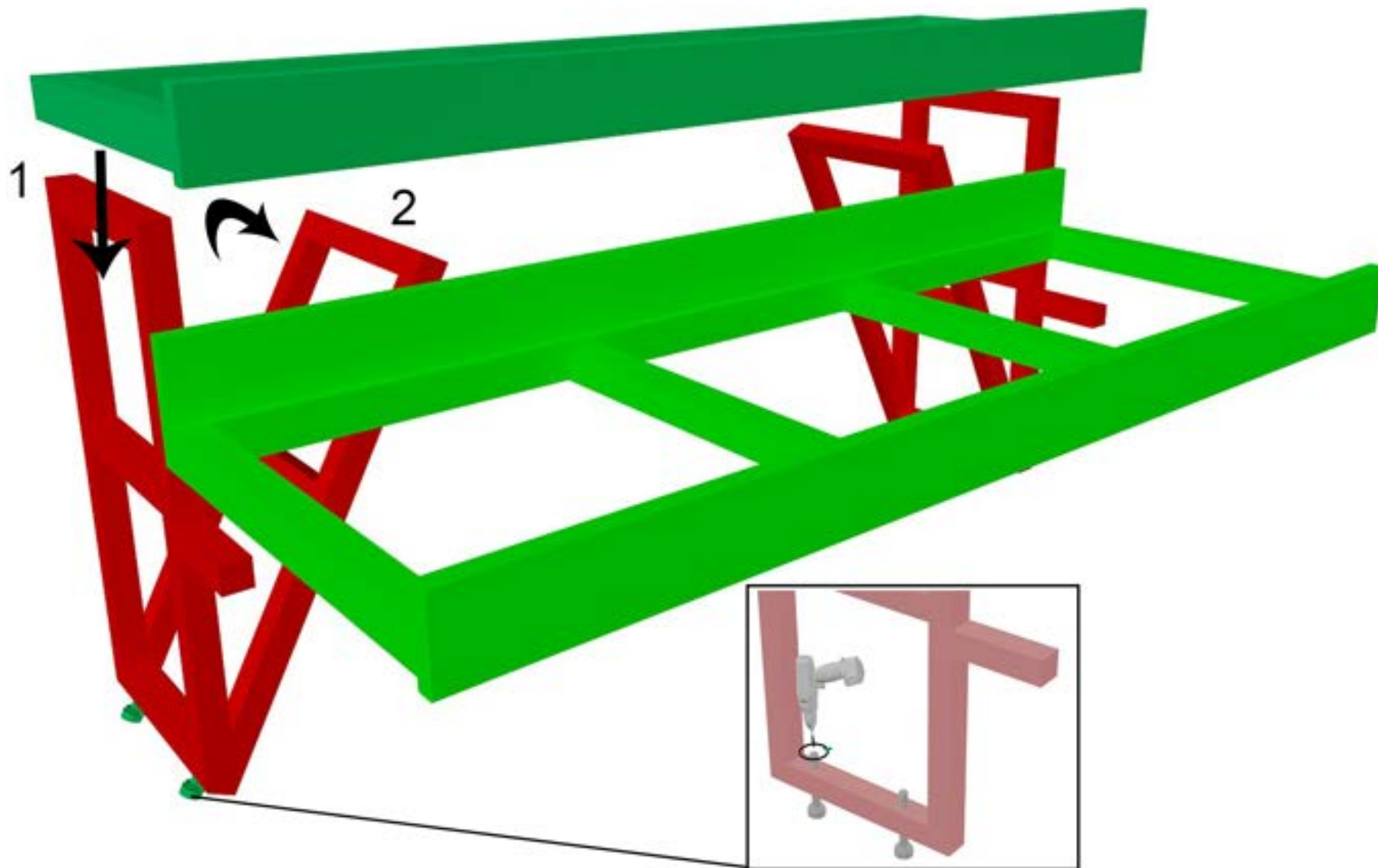

12. Wiring inside walls

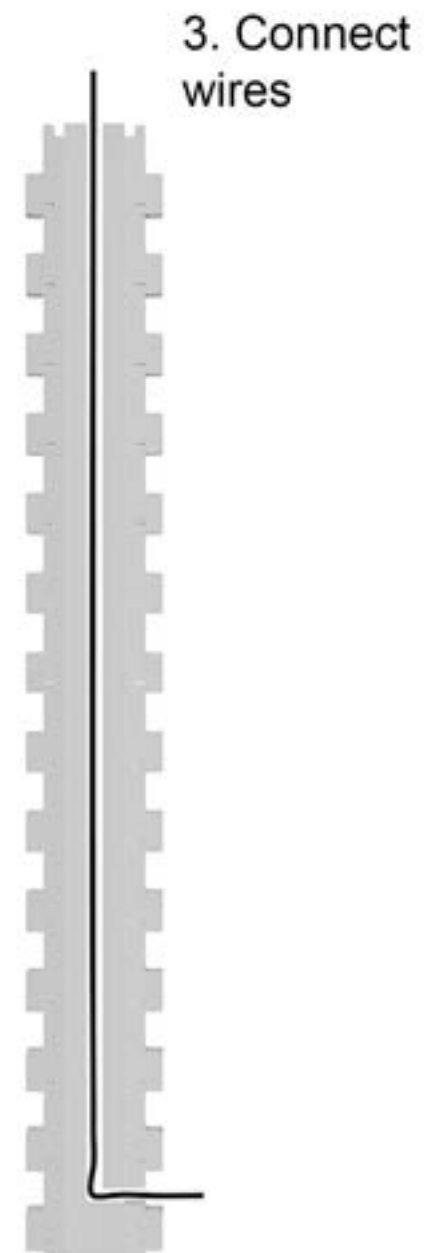
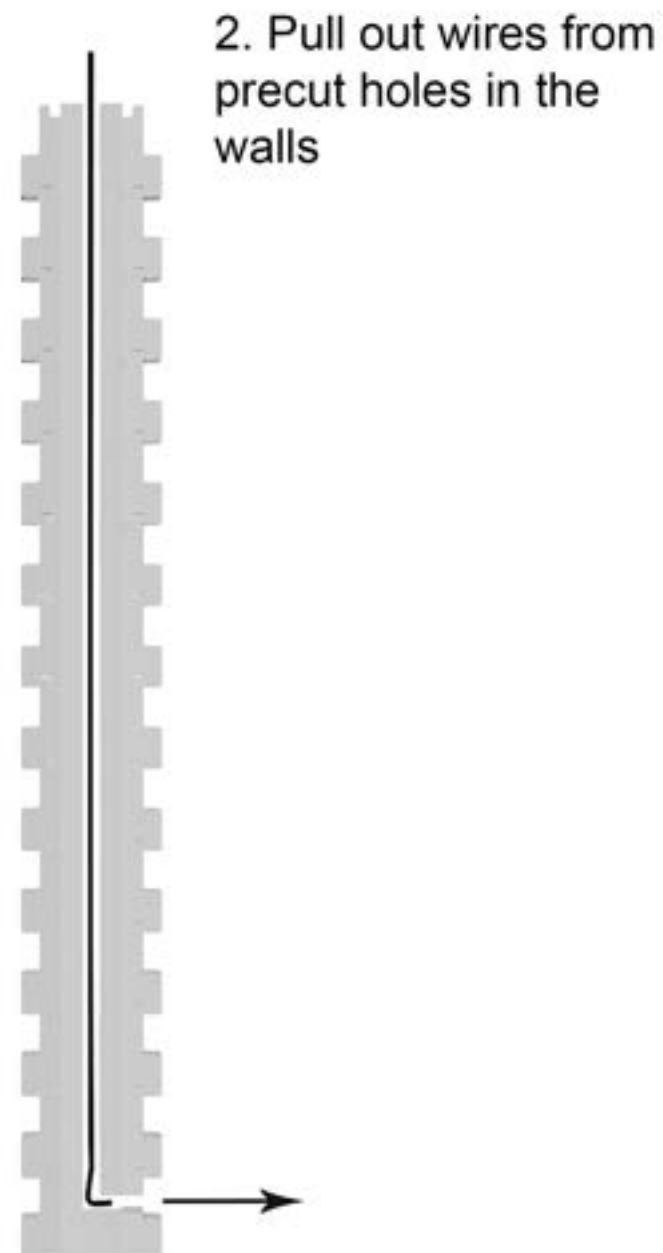
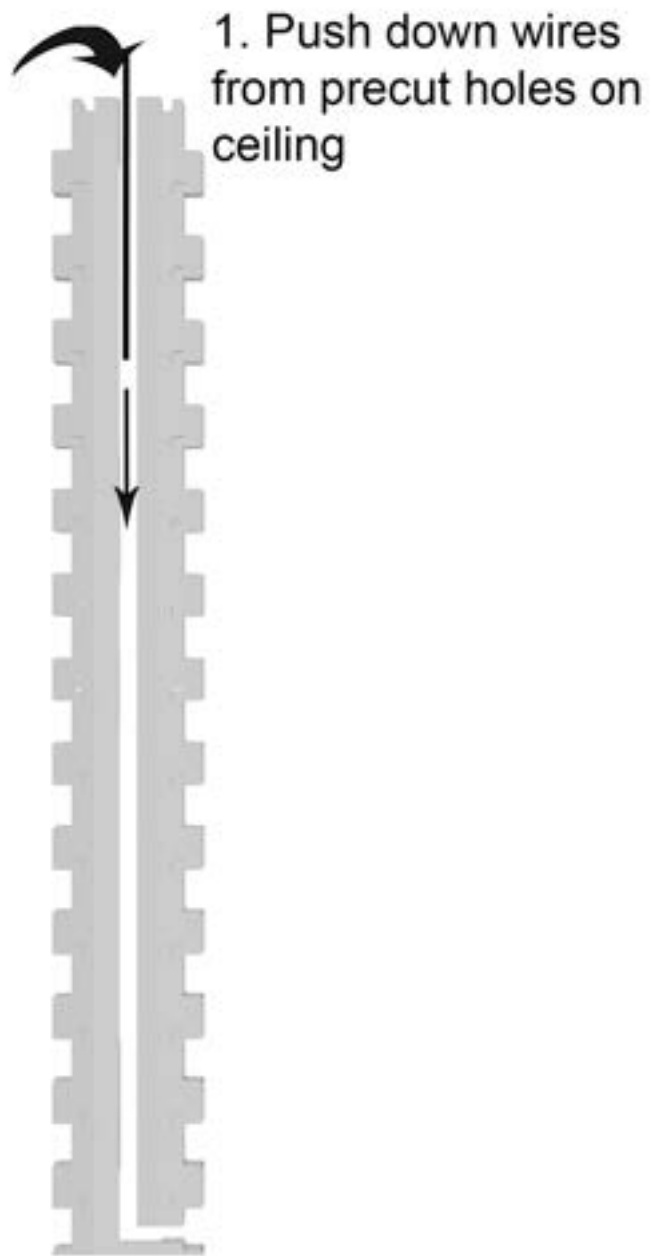

13. LED-strip connections

! Always use certified electrician

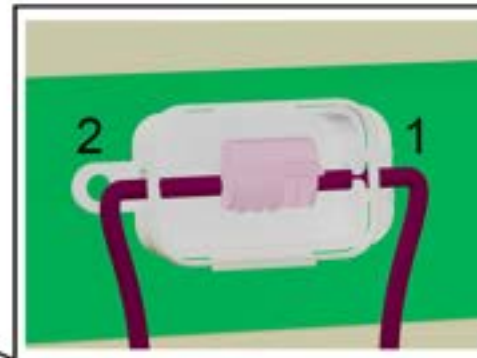
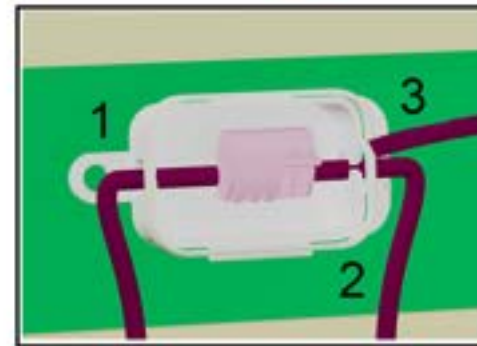
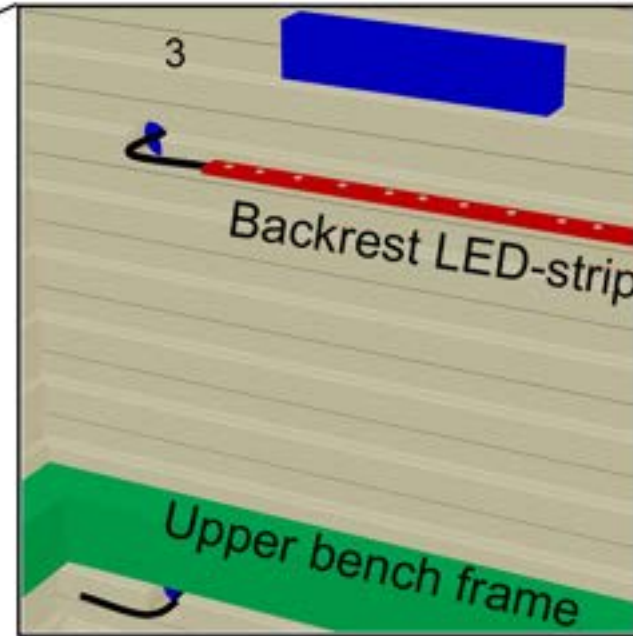
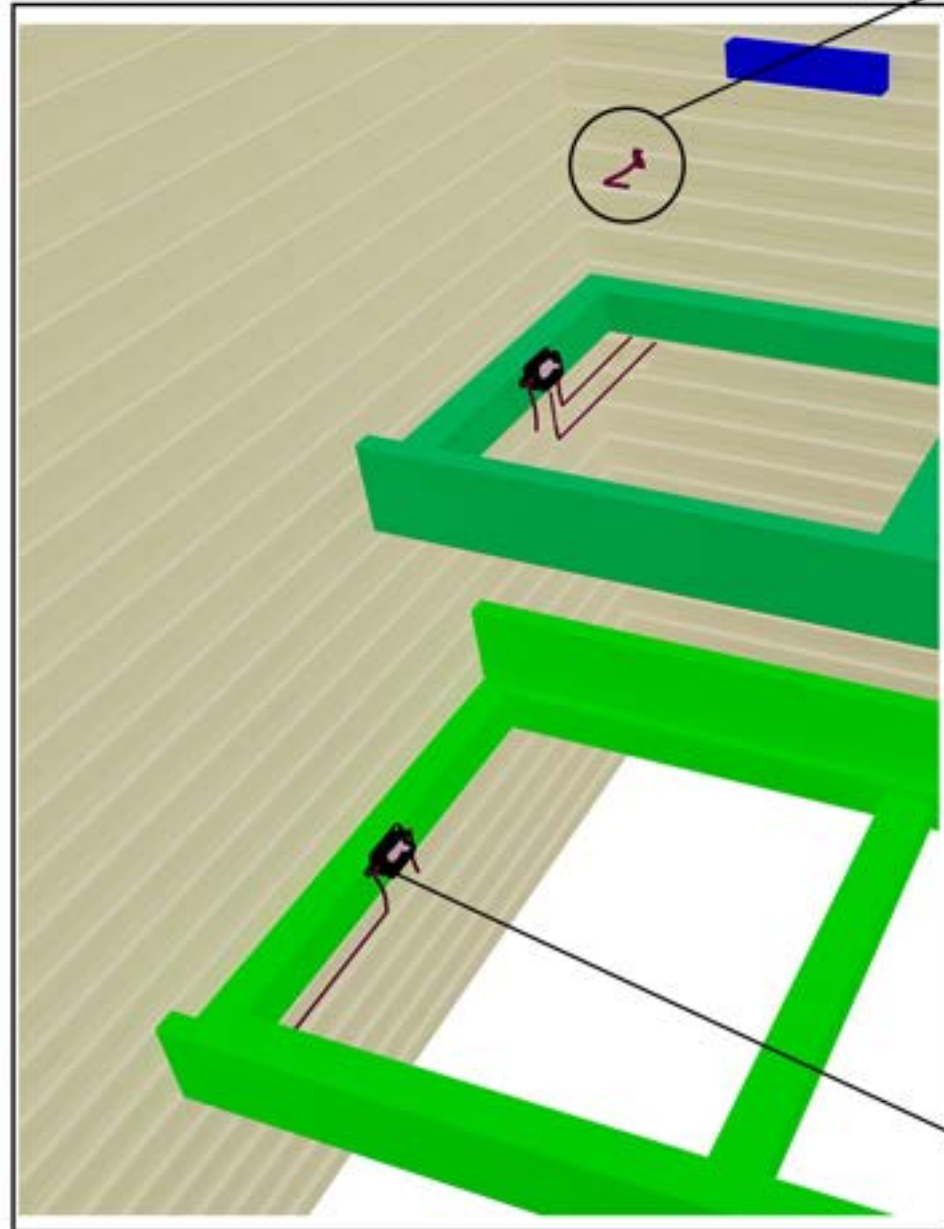

- 1. Wires from the ceiling
- 2. Bench LED-strip wires
- 3. Backrest LED-strip wire

14. Backrest & bench grids

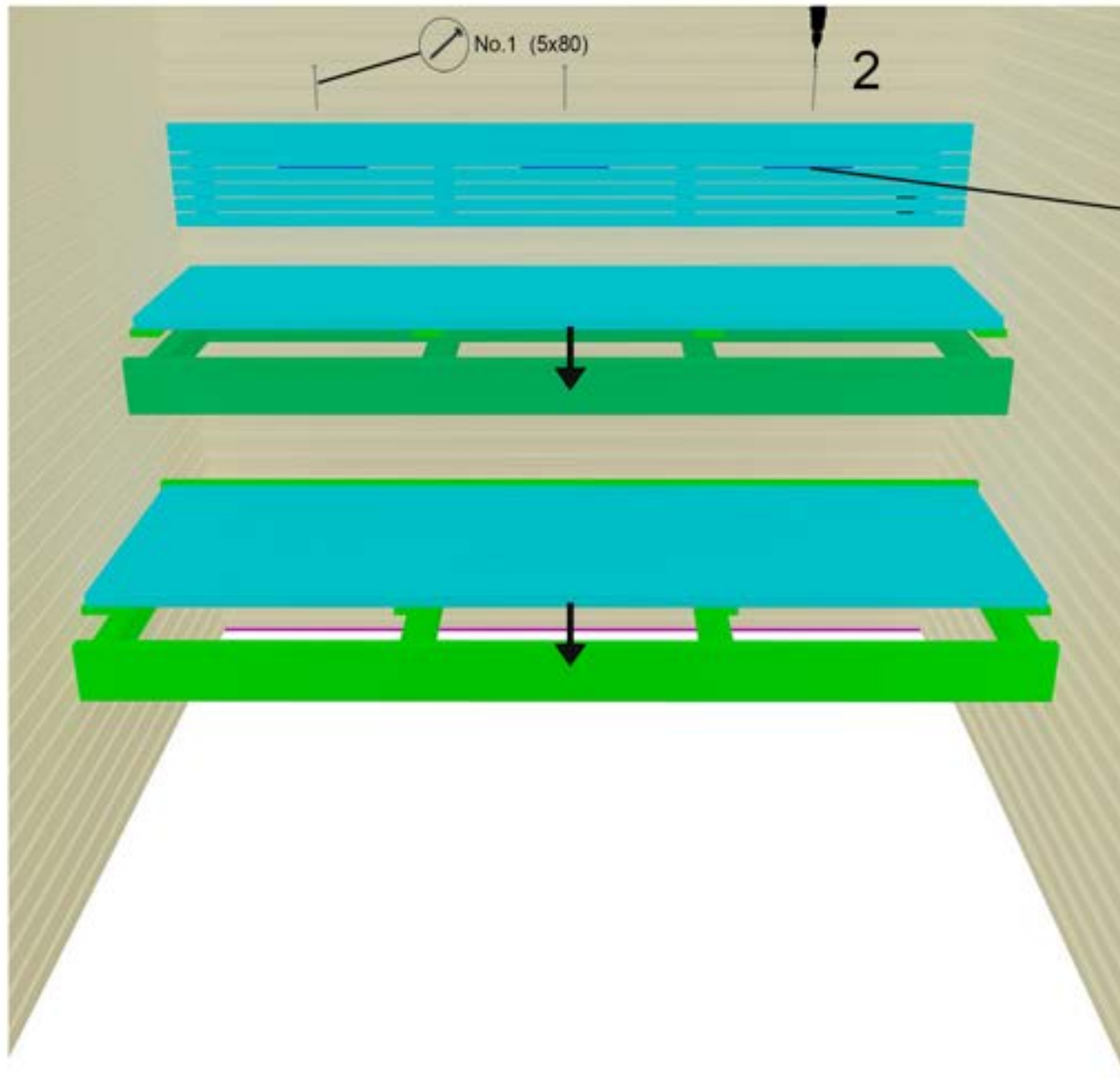

3. Fix LED-strip on top of backrest with glue (covers screws)

14.1 Fixing glass supports

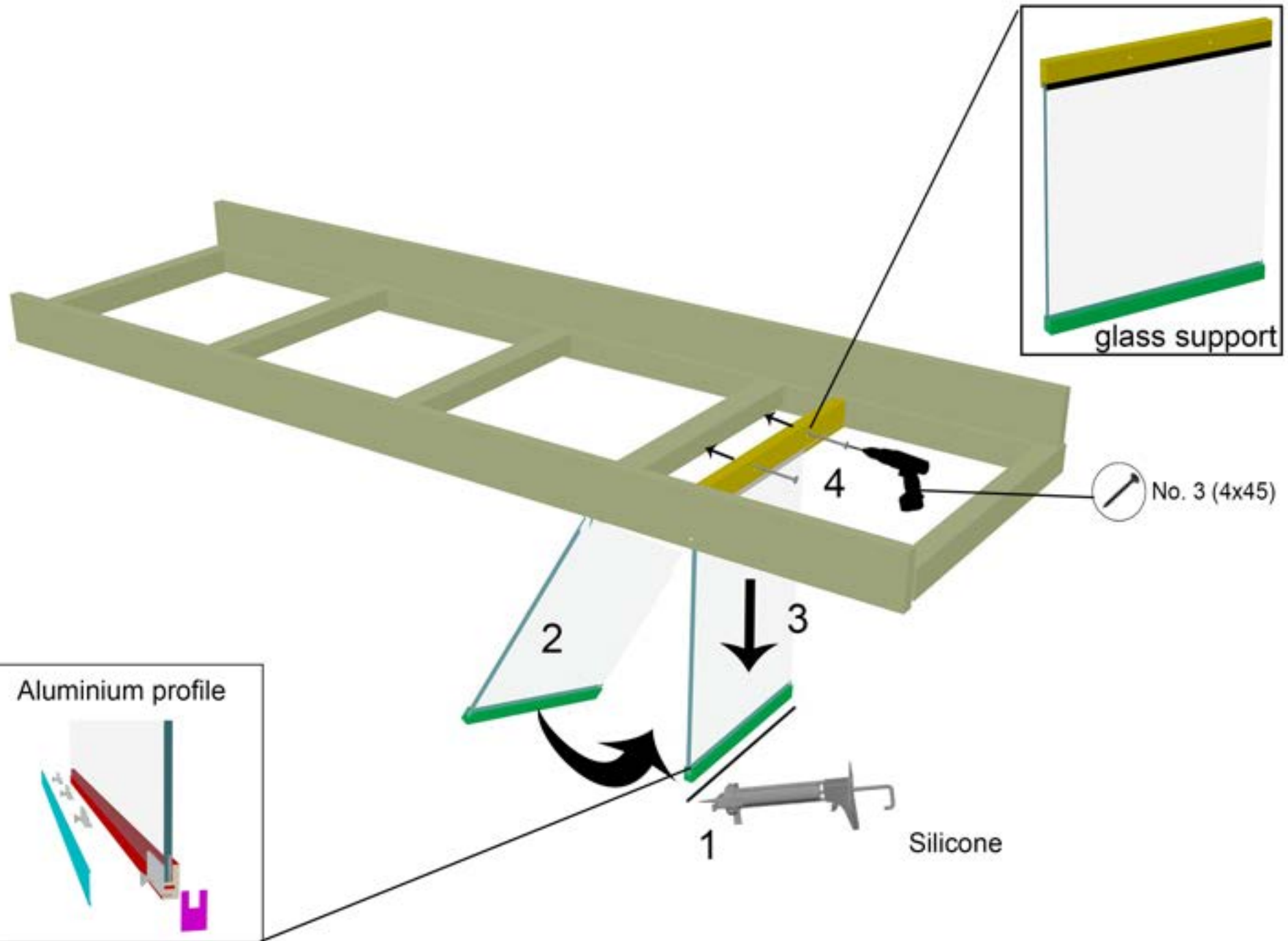

15. Interior II

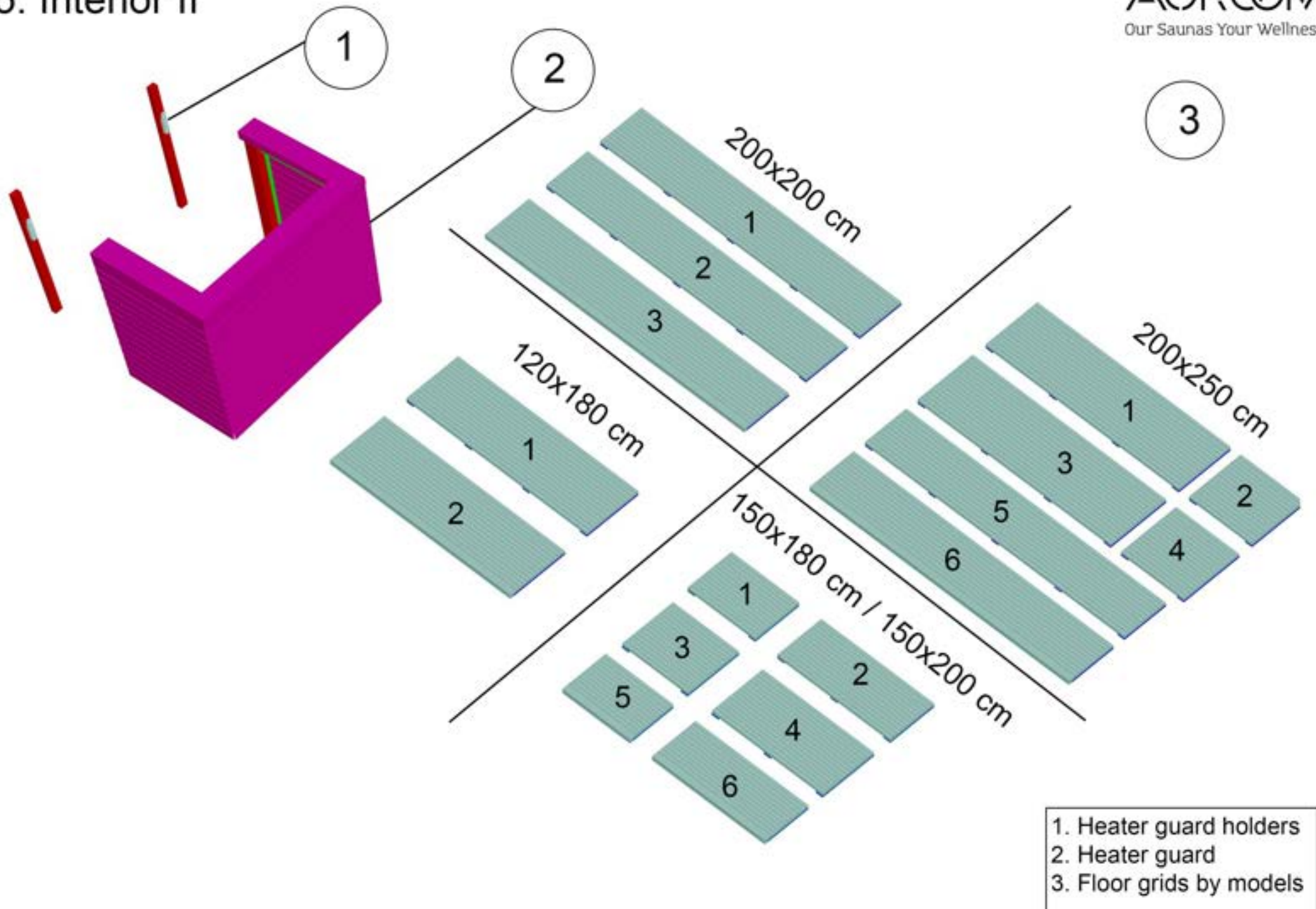

16. Heater guard

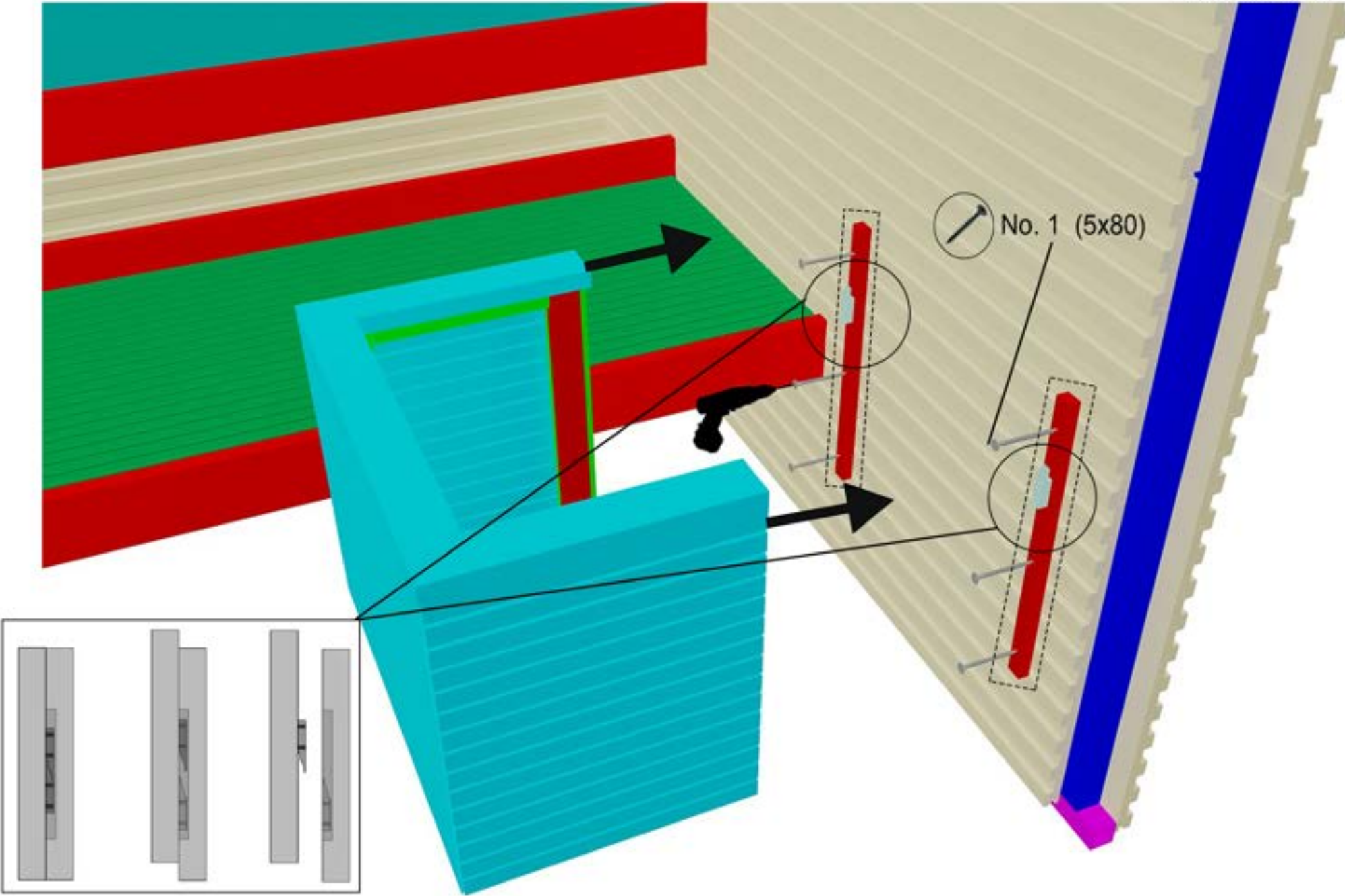

17. Door and glass wall

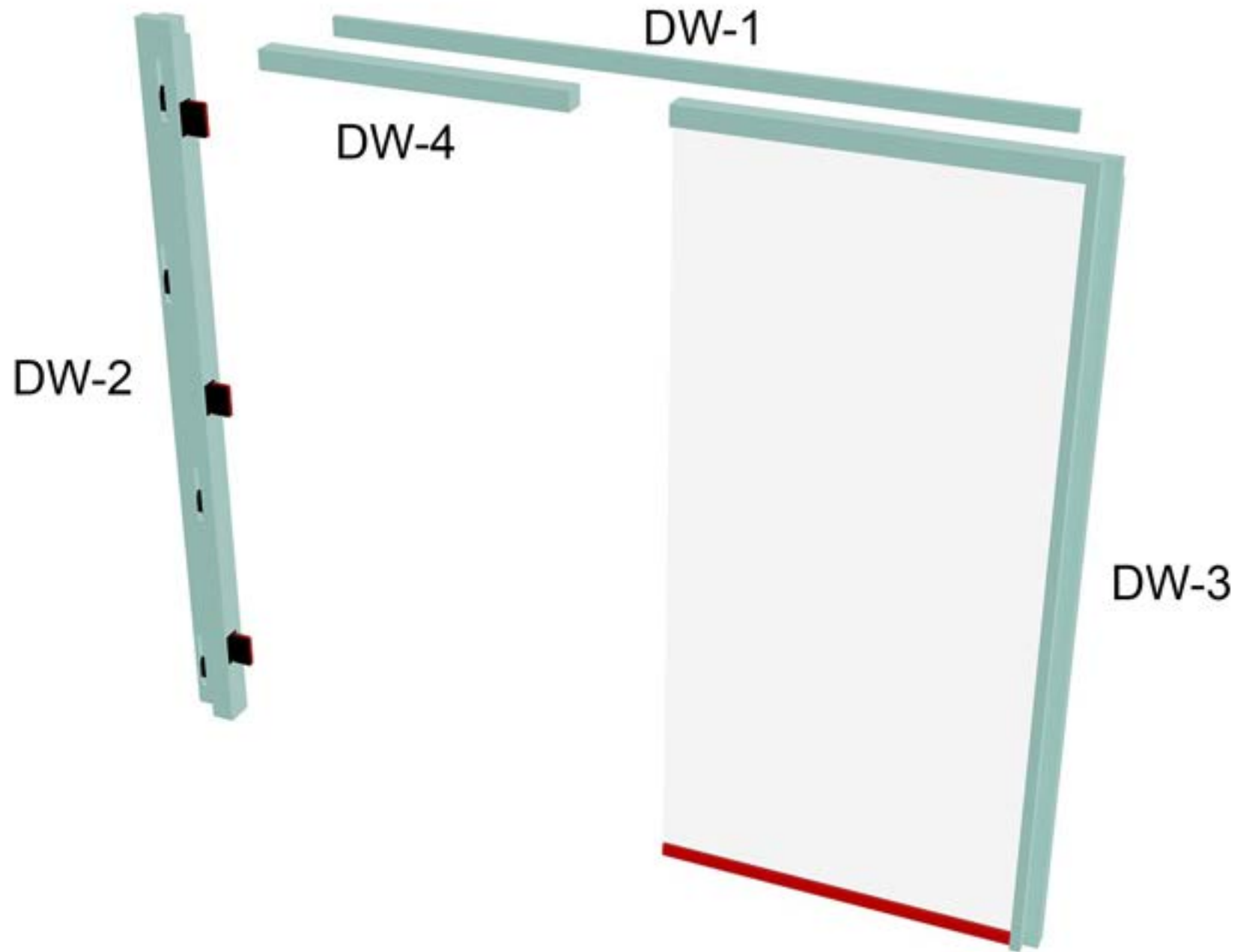

18. Fixing door & glass wall frame

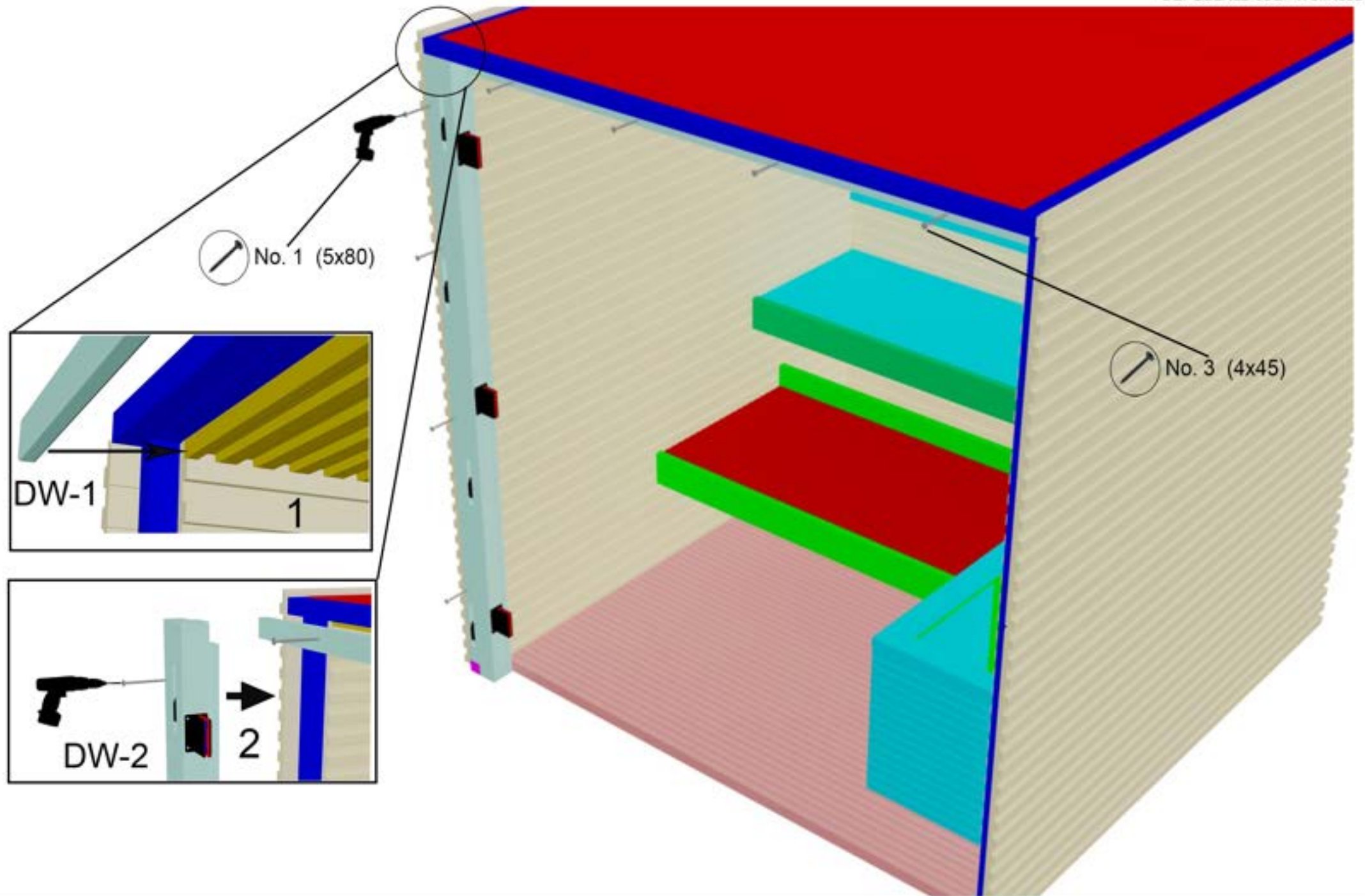

19. Aluminium profile fixing under glass wall

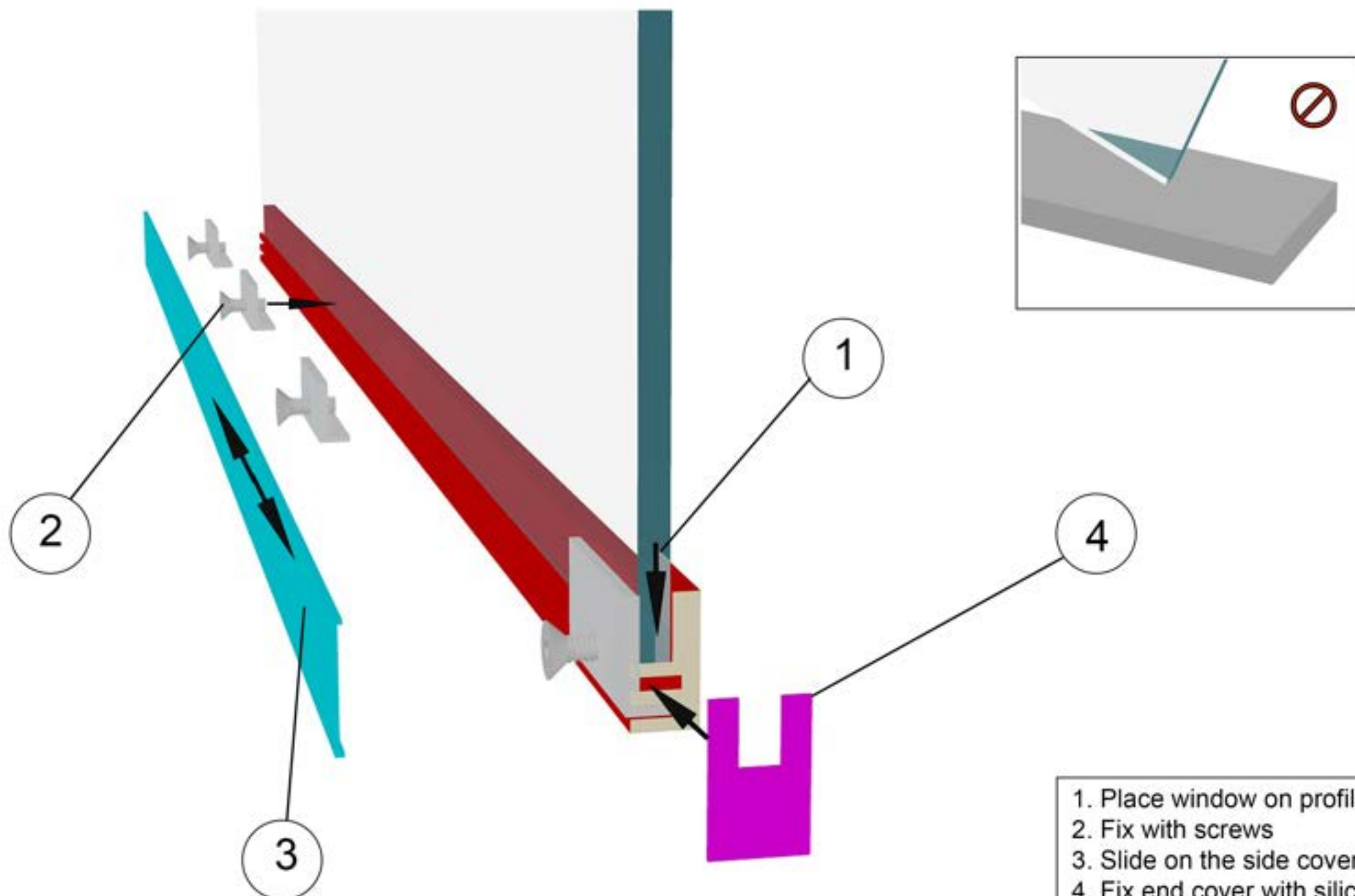

1. Place window on profile
2. Fix with screws
3. Slide on the side cover
4. Fix end cover with silicone

20. Fixing door & glass wall frame

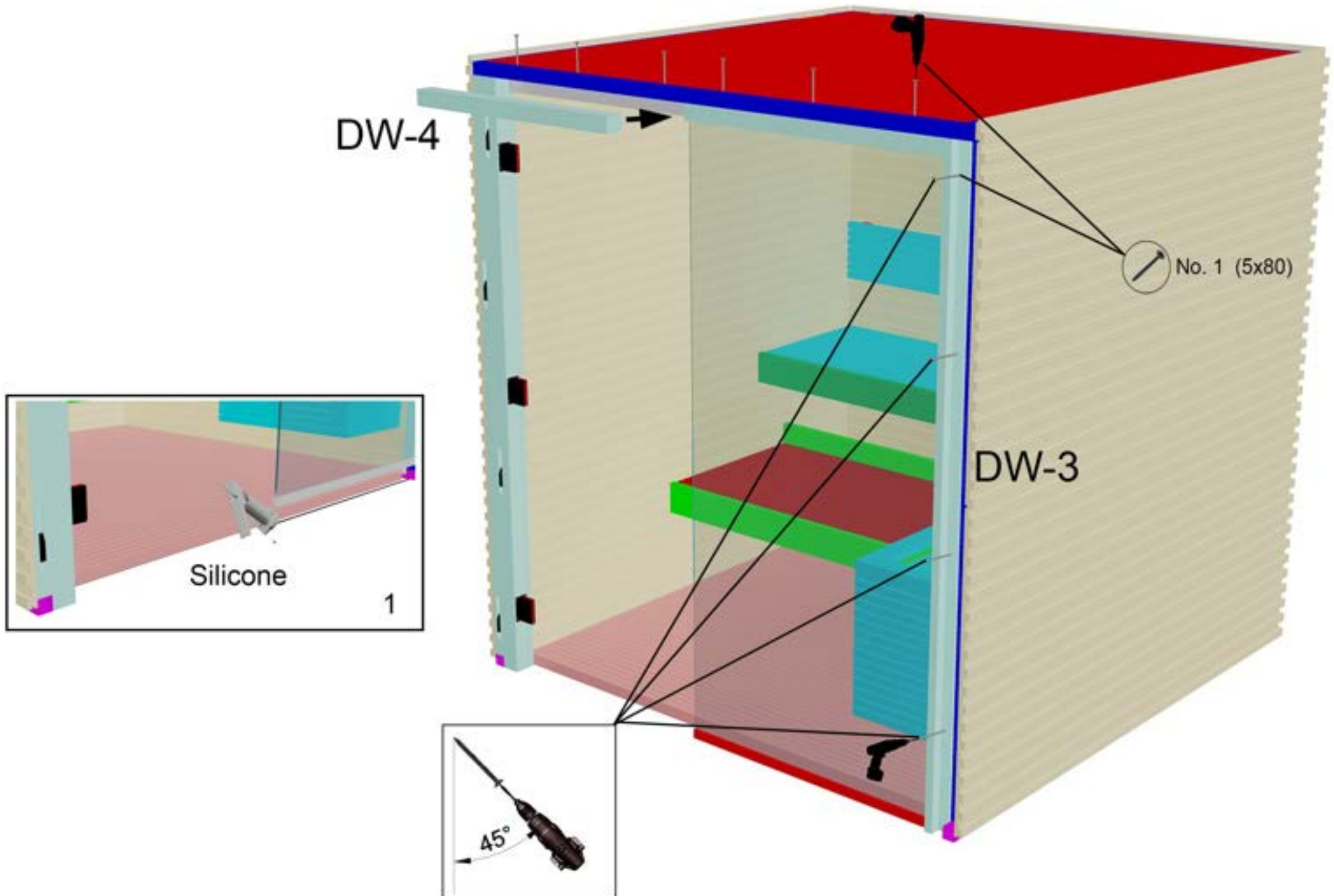

21. Adjusting glass wall

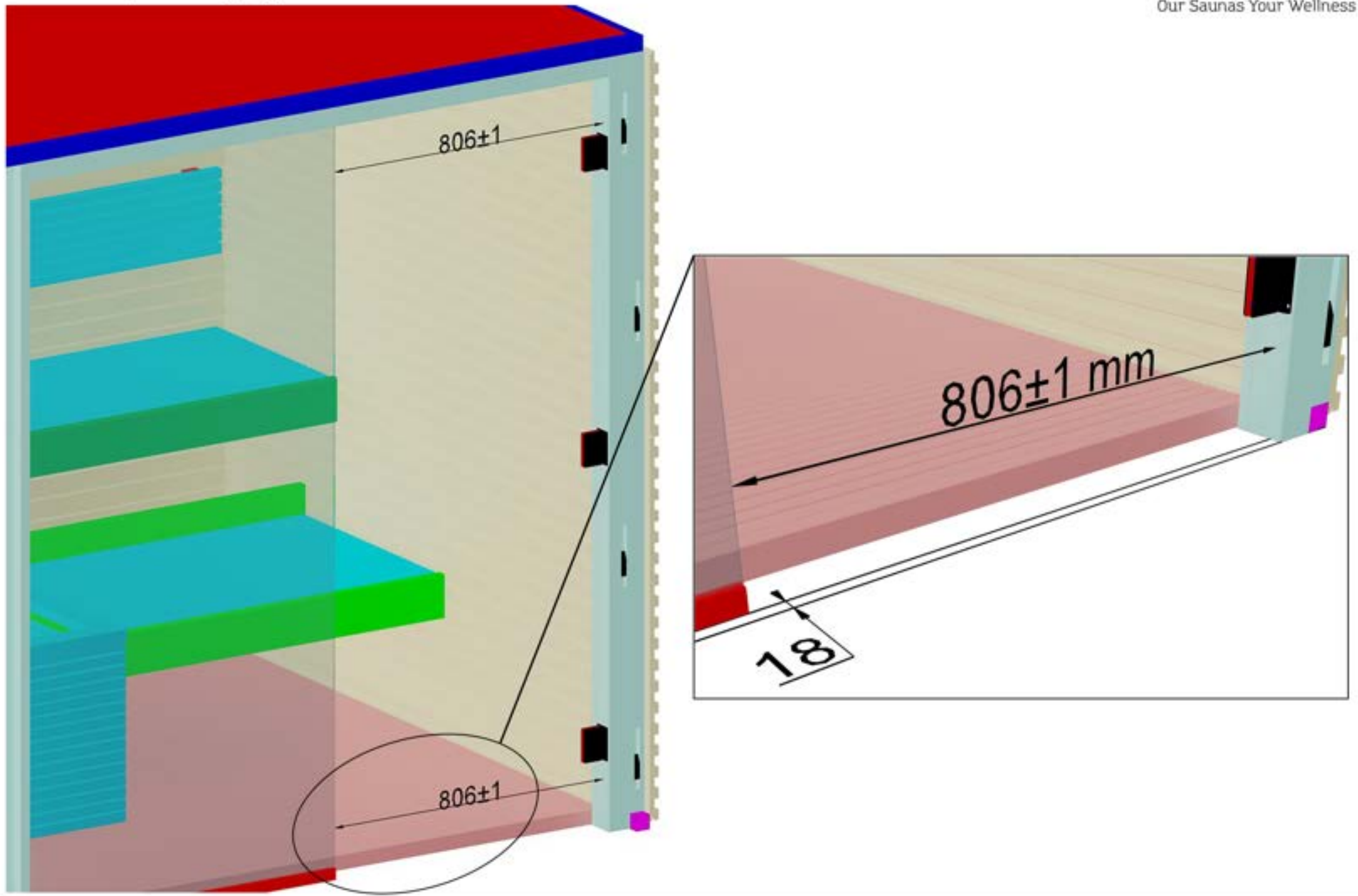

22. Fixing Detail 1



1

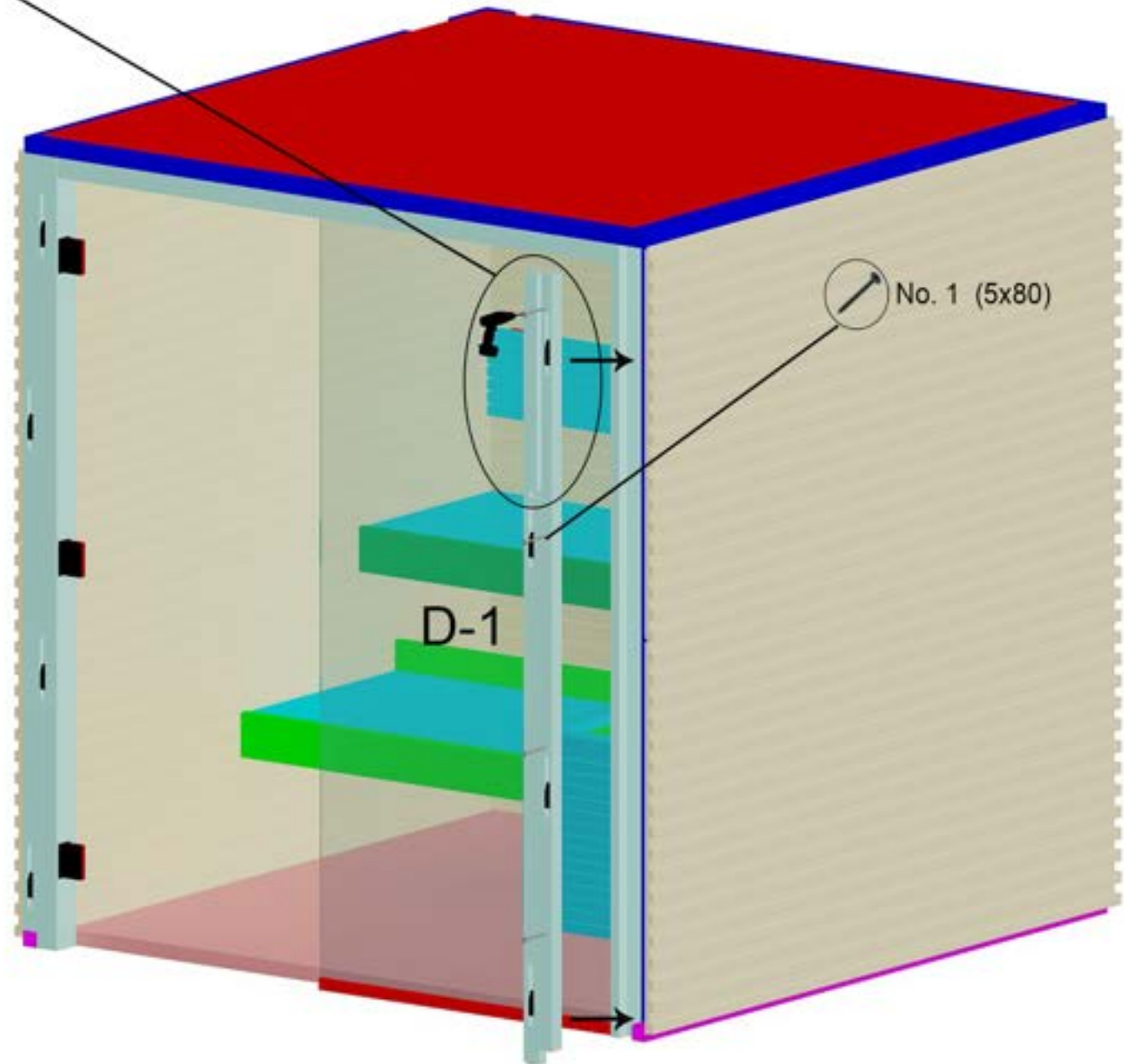

No. 1 (5x80)

D-1

1. Cut out for
control unit cable

23. Upper frame

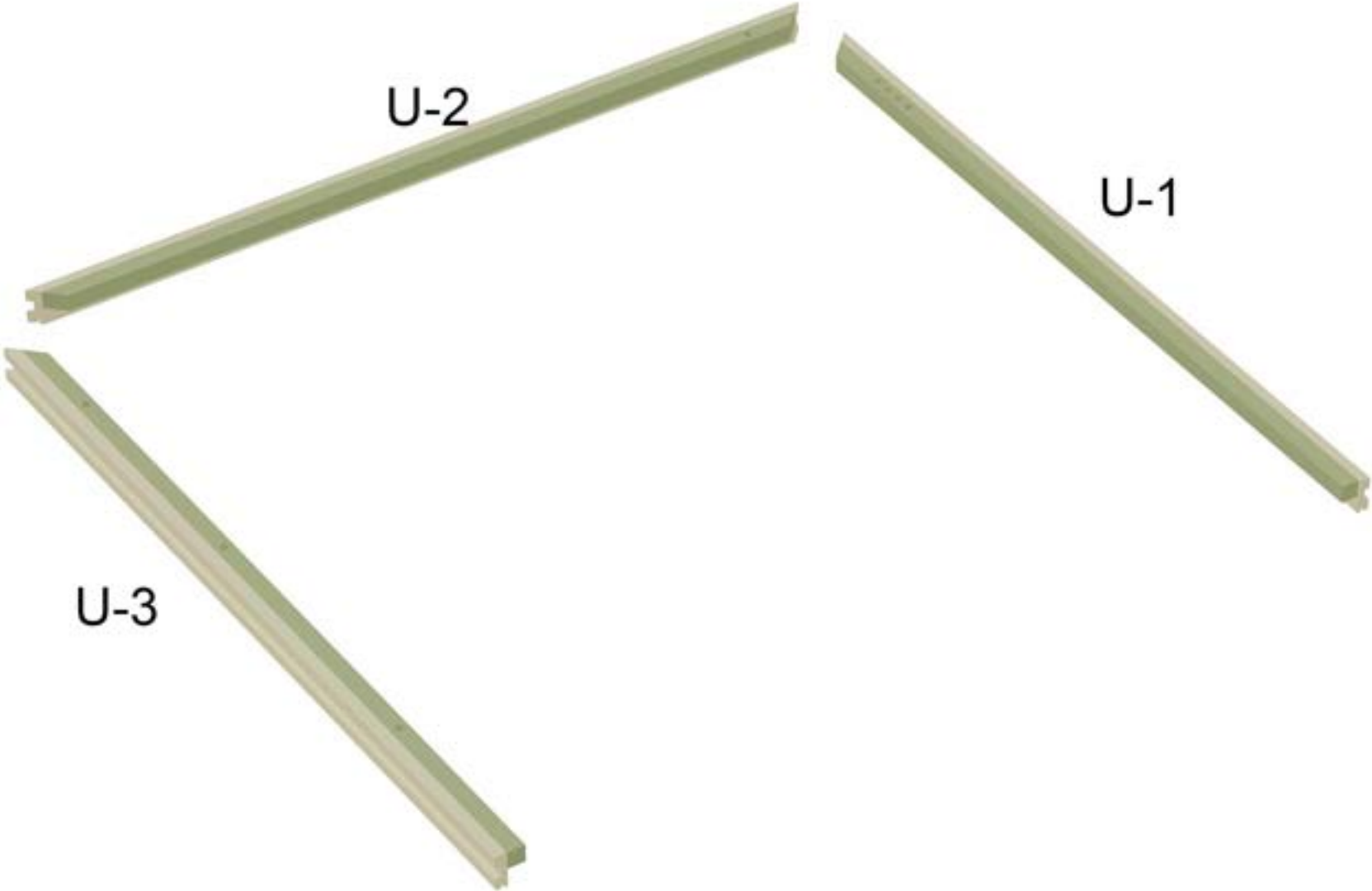

24. Fixing upper frame

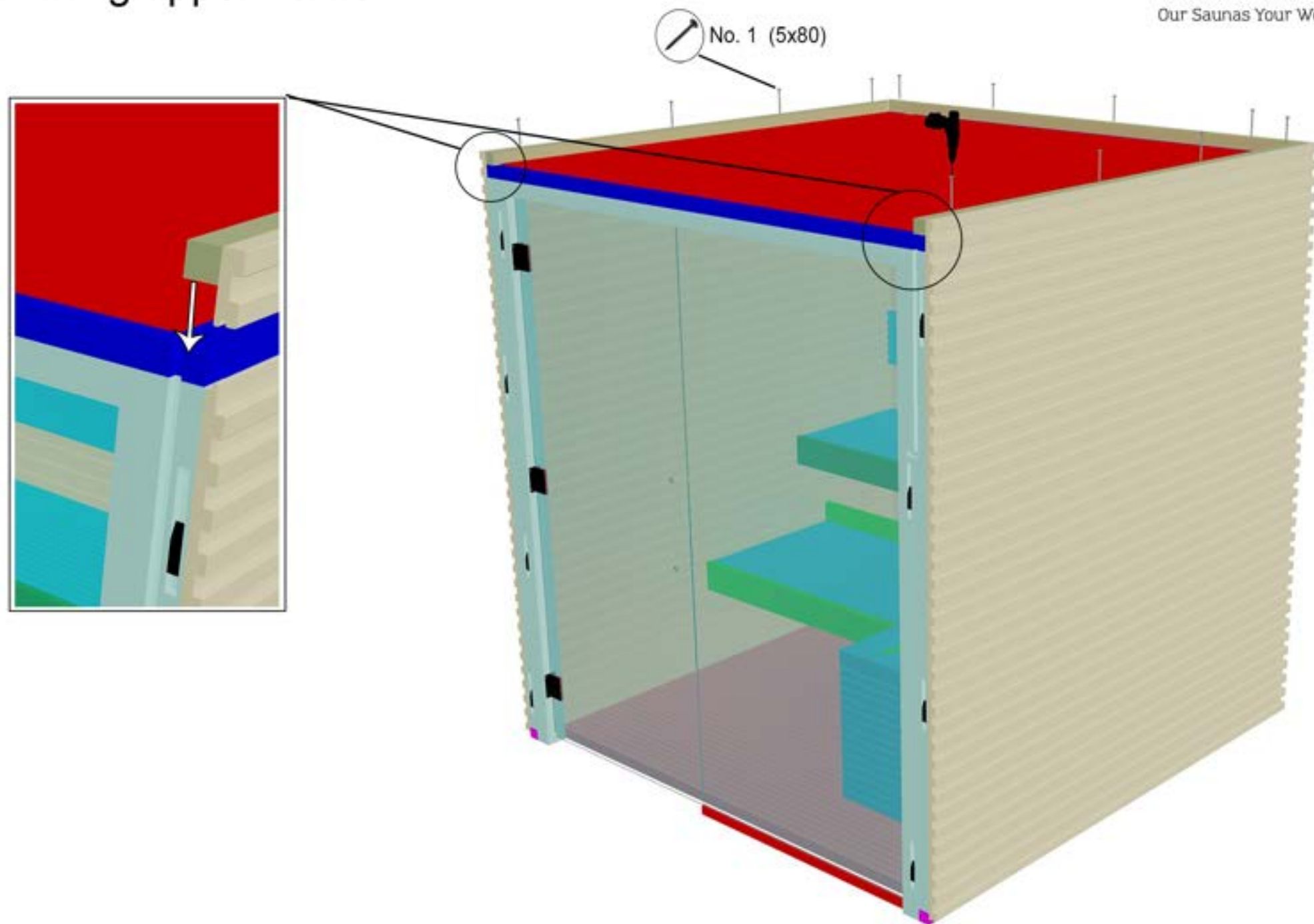

25. Door hinges and handle

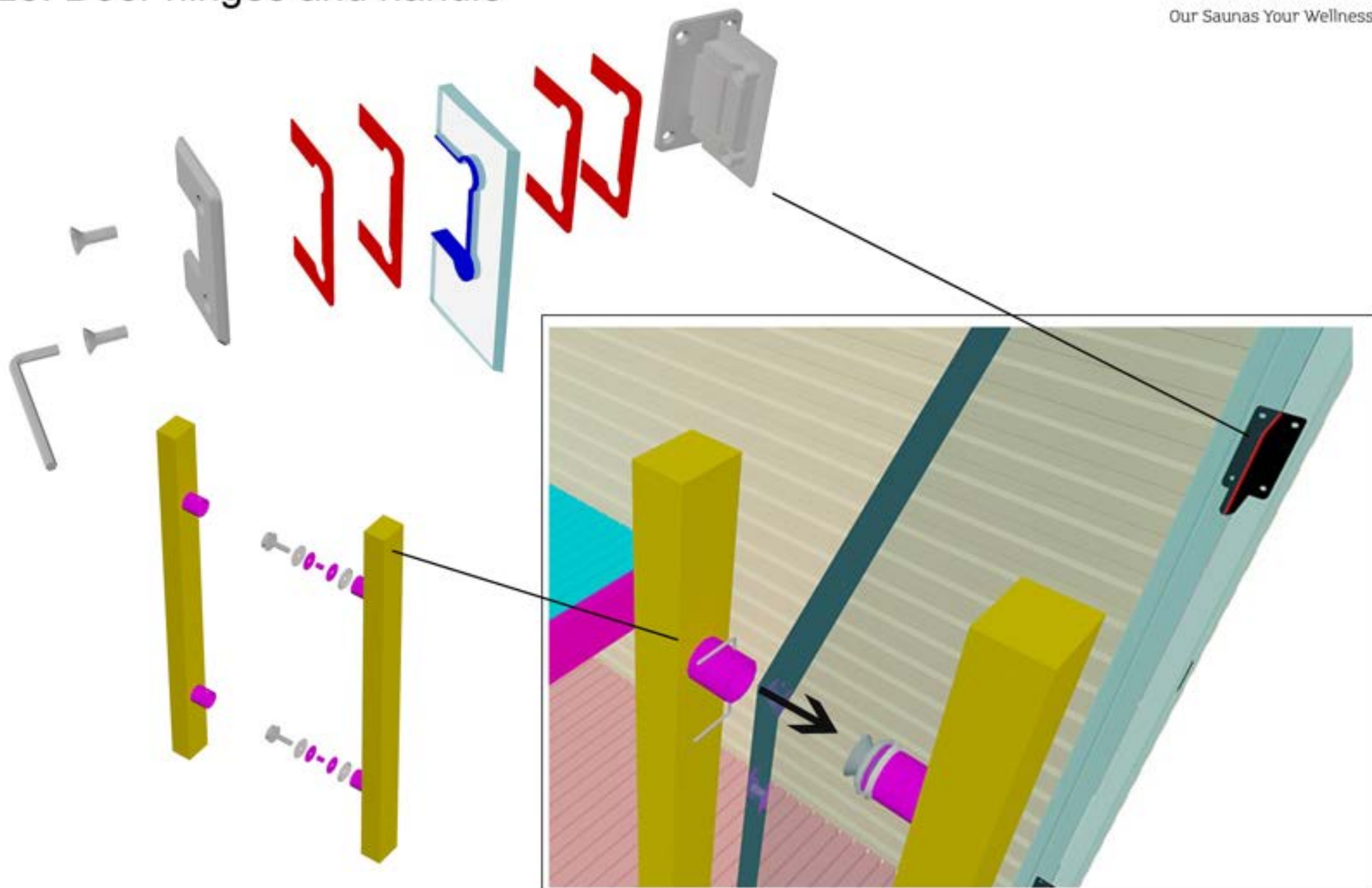

26. Control unit cable mounting

FF-1

3

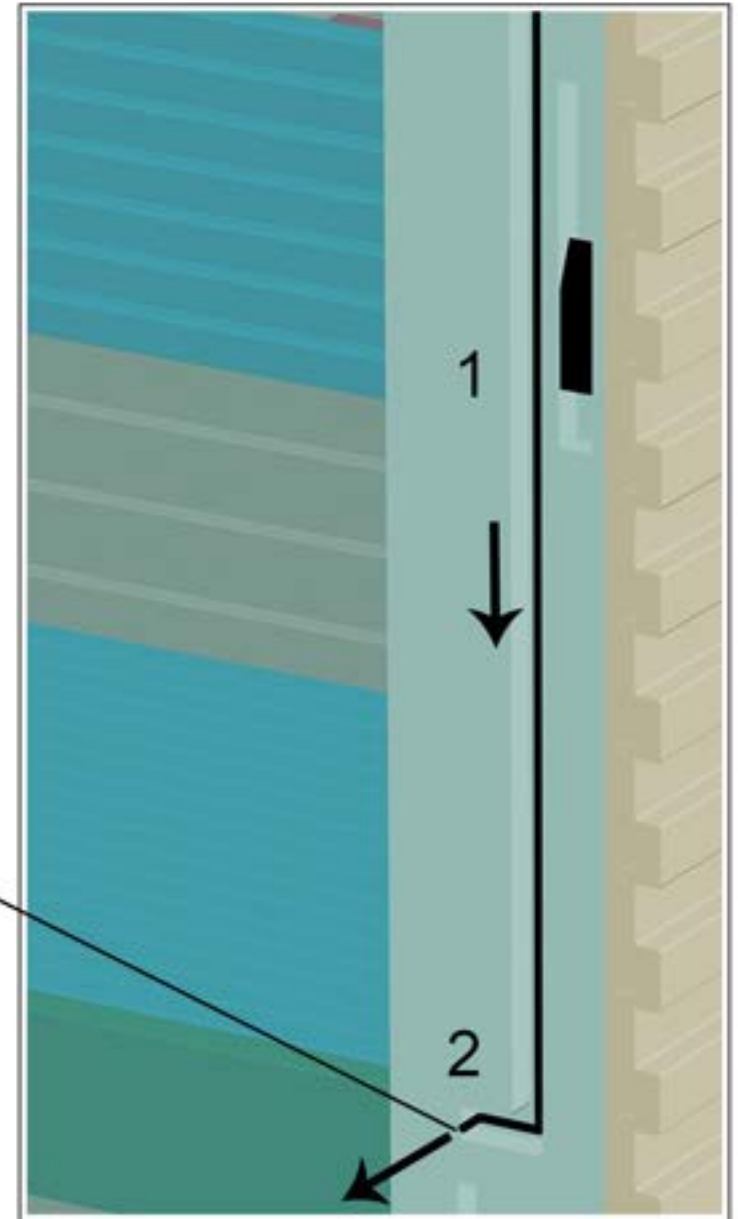

1. Put control unit cable inside (D-1) precut
2. Make sure cable stays in precut and install front frame detail (FF-1)
3. Pull out cable from hole in front frame

27. Front frame

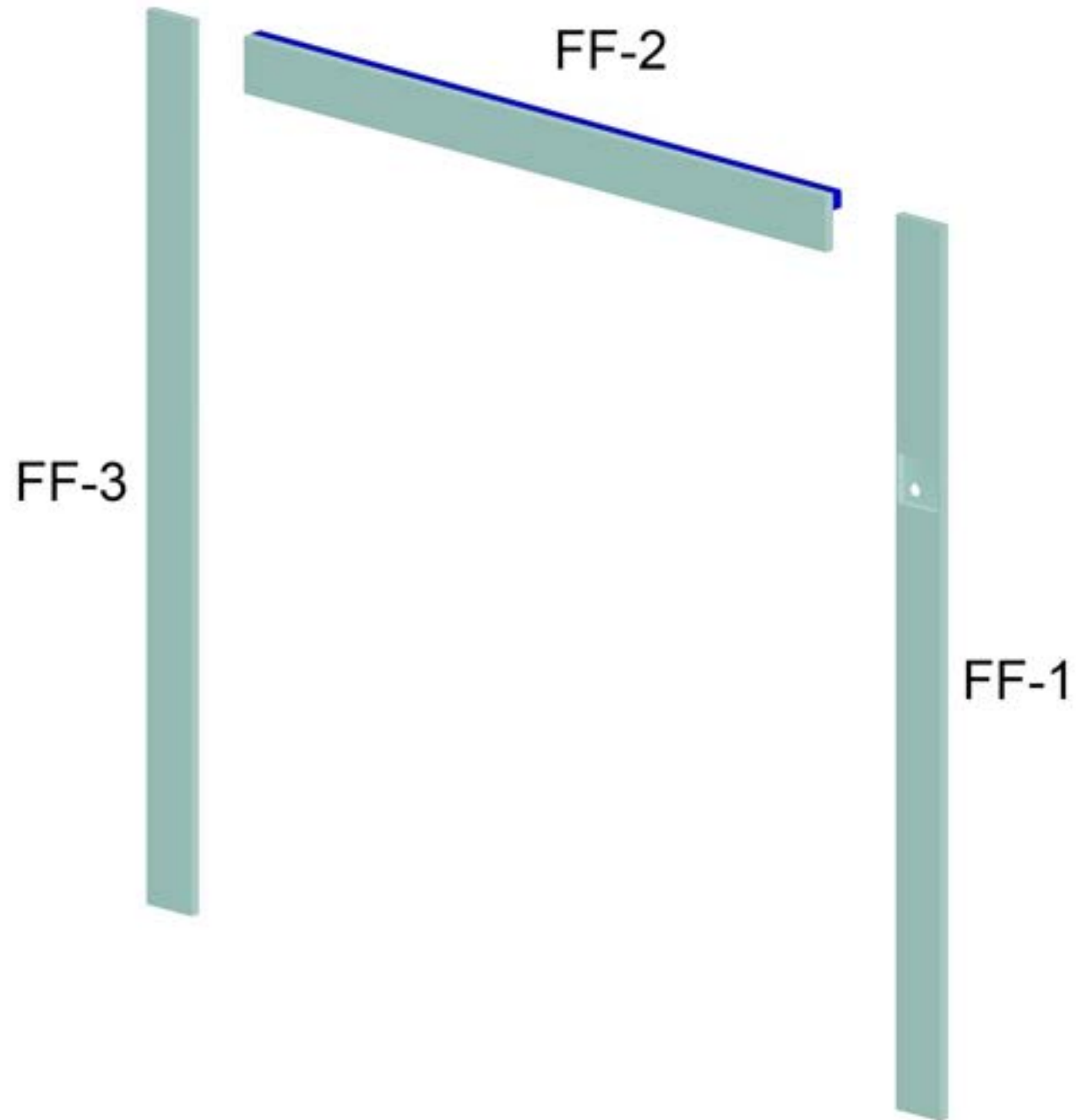

28. Fixing front frame

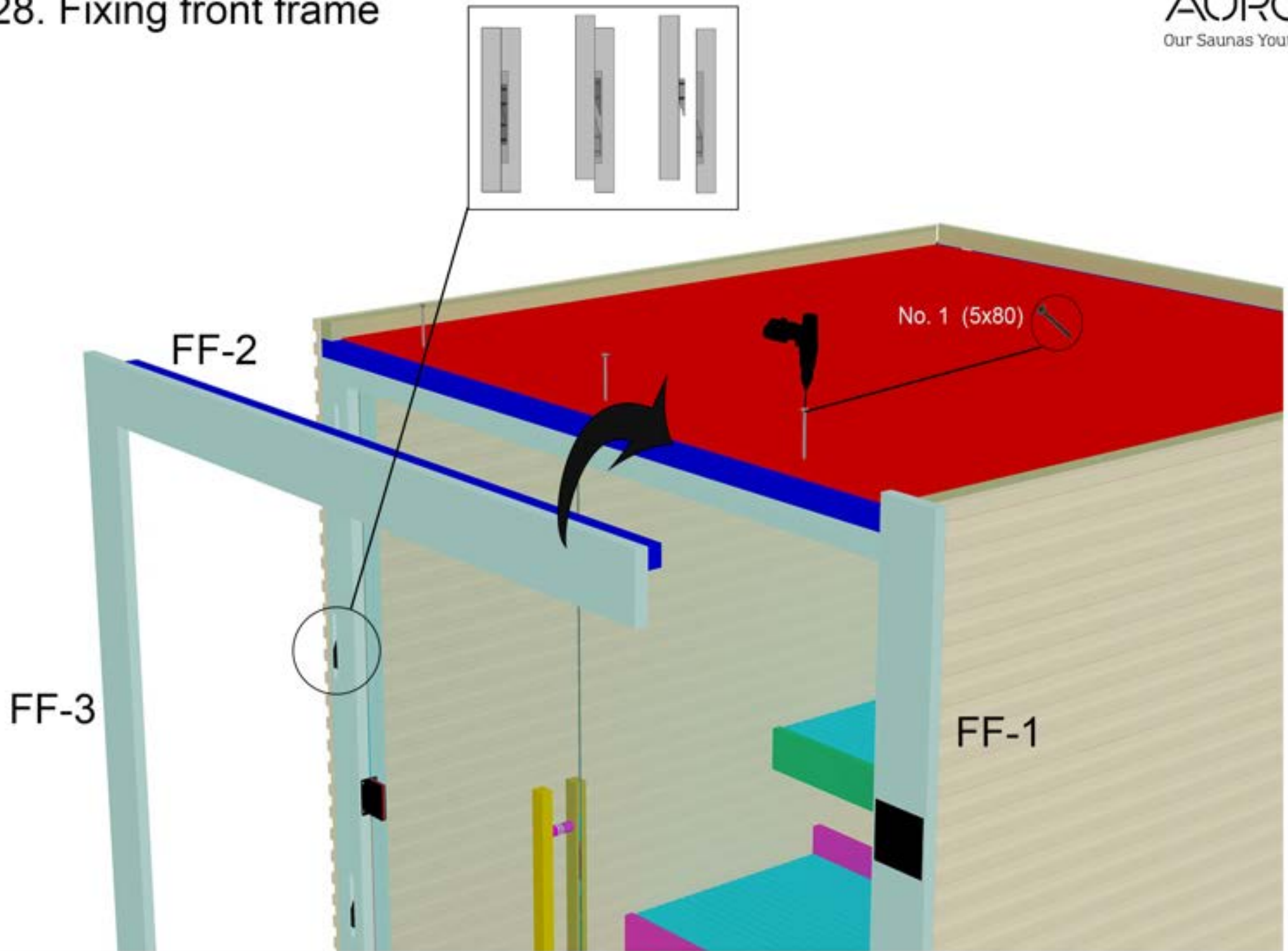

29. Wiring on ceiling

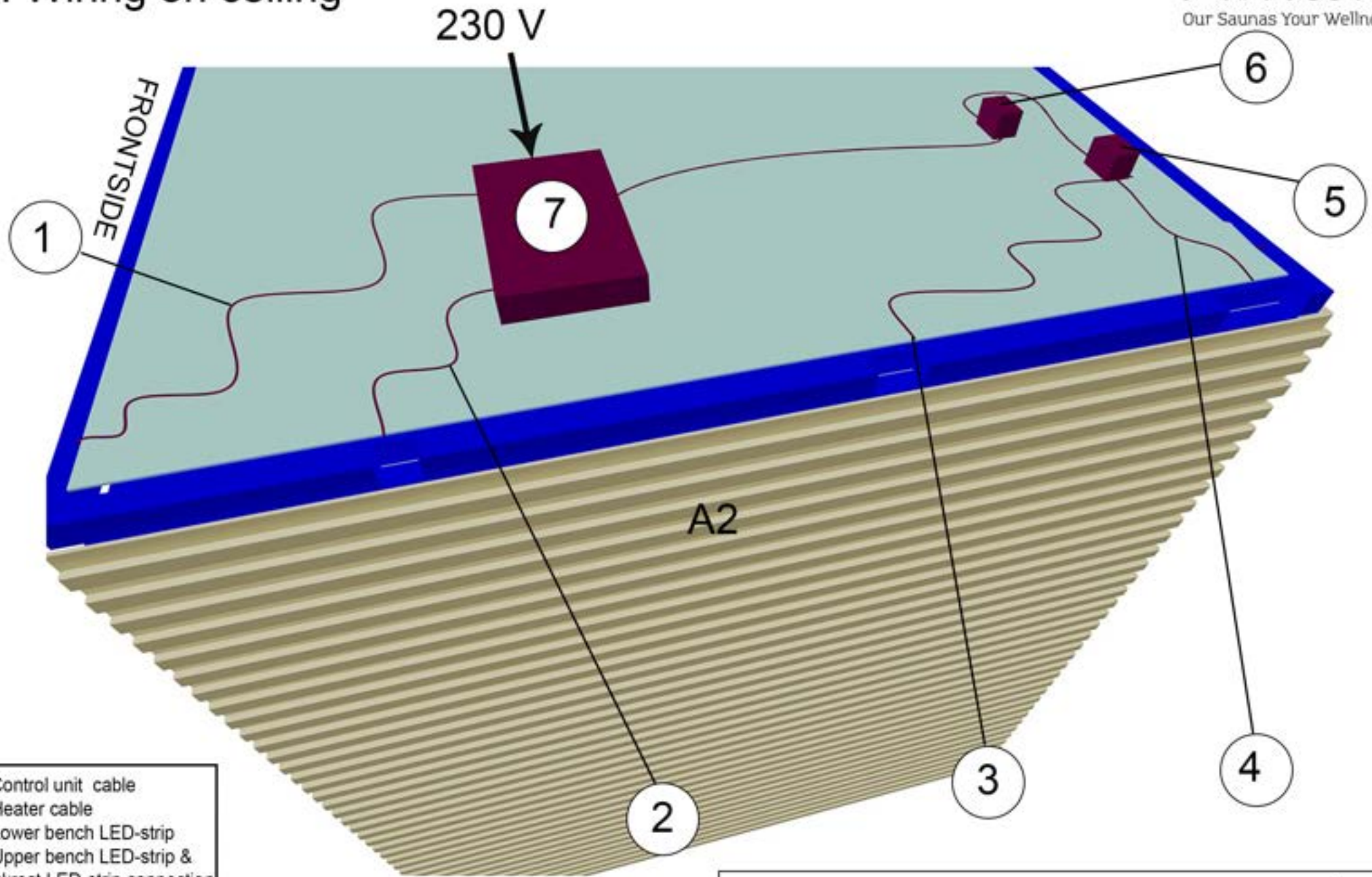

1. Control unit cable
2. Heater cable
3. Lower bench LED-strip
4. Upper bench LED-strip & Backrest LED-strip connection
5. LED-strip junction boxes
6. Transformer
7. Power unit

Always use a certified electrician !