



Model X7 Sauna Room Installation Manual



Congratulations on your purchase of the SaunaLife X7 model sauna! If you have any questions during assembly, please feel free to call us at 1-800-957-2862, or email info@saunalife.com. Regular business hours are 8 a.m. - 5 p.m. Central, M-F.

Your SaunaLife X7 sauna is specifically designed to utilize your existing floor. As such, assembly is made very simple since the entire sauna sits on pre-fabricated rails and risers. Your sauna can be assembled on any surface that is firm and flat, including concrete, ceramic, vinyl, laminate or tile. Installation on a carpeted surface is not recommended.

SaunaLife X7 Kit Contents:

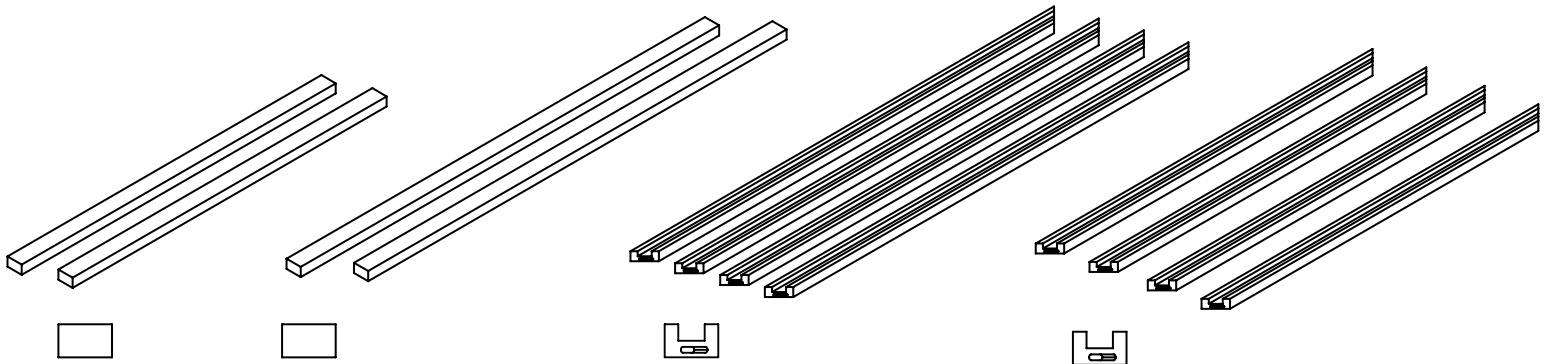

Floor raiser 1
(qty. 2)

Floor raiser 2
(qty. 2)

Support rail 1
(qty. 4)

Support rail 2
(qty. 4)

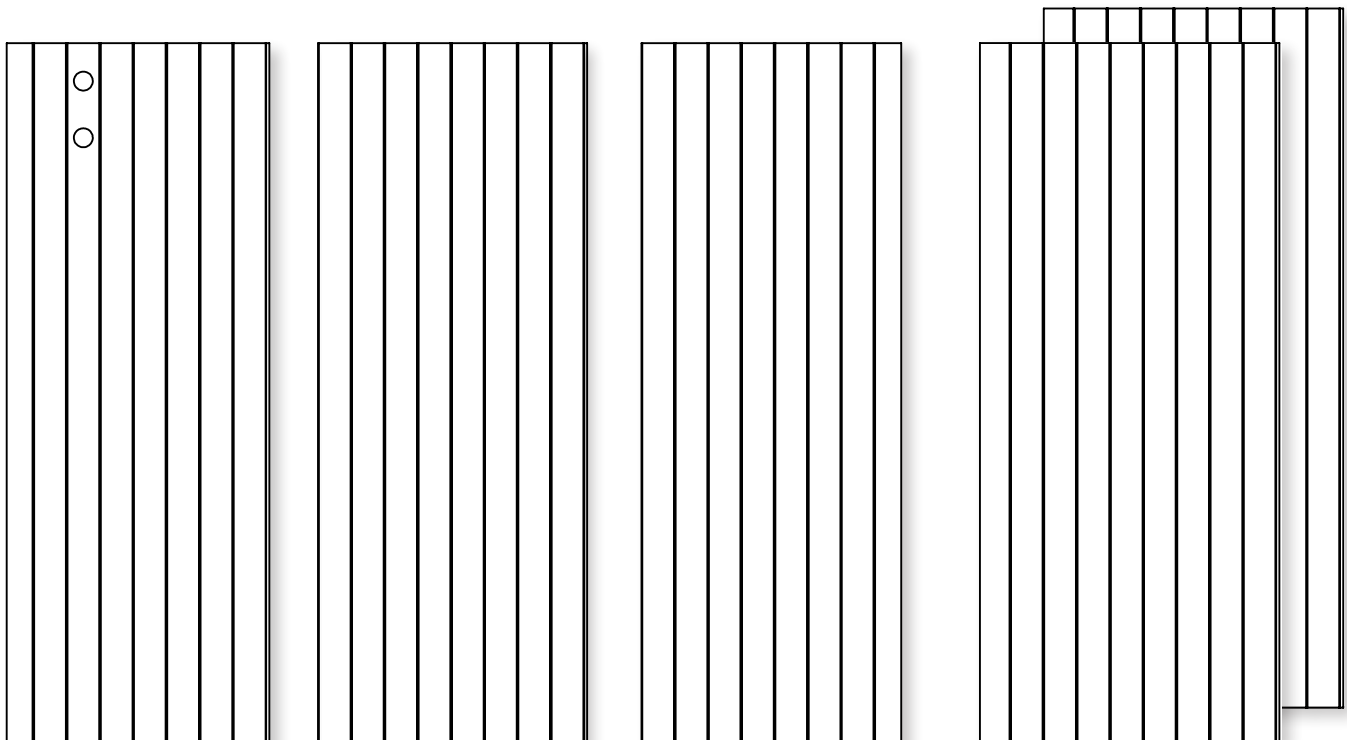

Back wall 1 (qty. 1)

Back wall 2 (qty. 1)

Back wall 3 (qty. 1)

Side wall 1 (qty. 2)

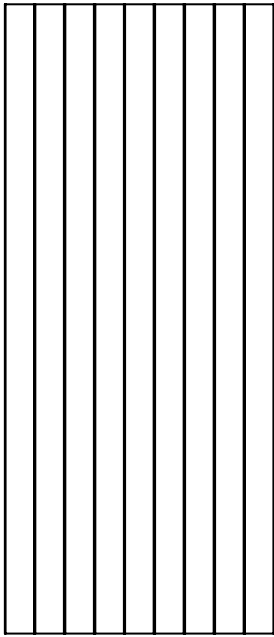

Side wall 2 (qty. 1)

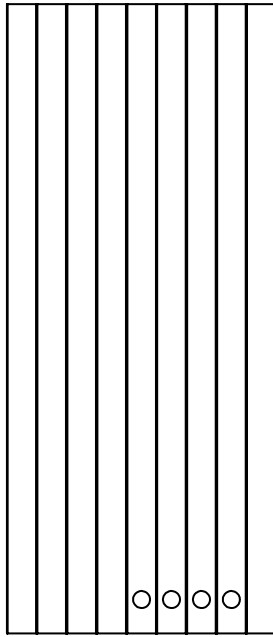

Side wall 3 (qty. 1)

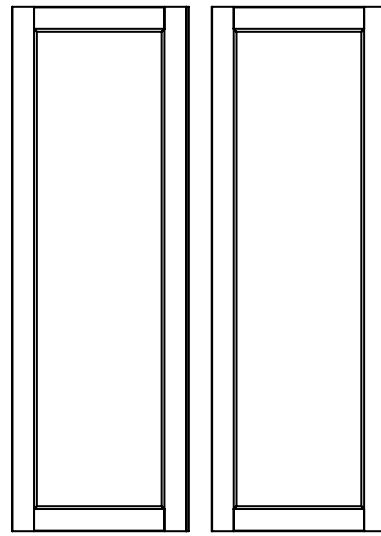

Window element (qty. 2)

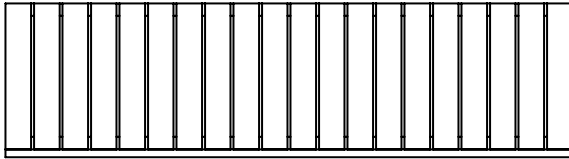

Bench (qty. 1)



Lower bench (qty. 1)

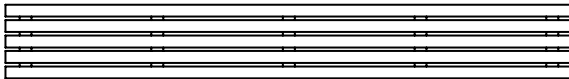

Backrest 1 (qty. 1)



Backrest 2 (qty. 1)

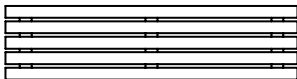

Backrest 3 (qty. 1)

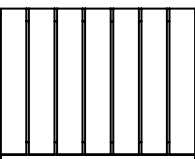

Side bench (qty. 1)

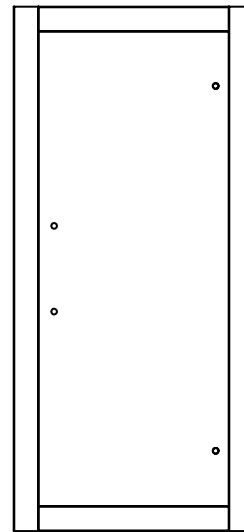

May be
configured left
or right-handed

Door element (qty. 1)

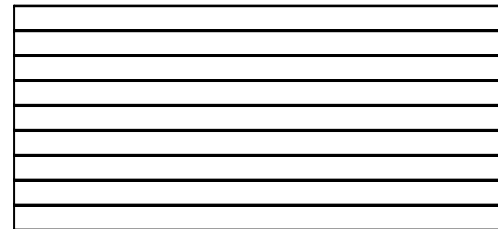

Roof 1 (qty. 1)

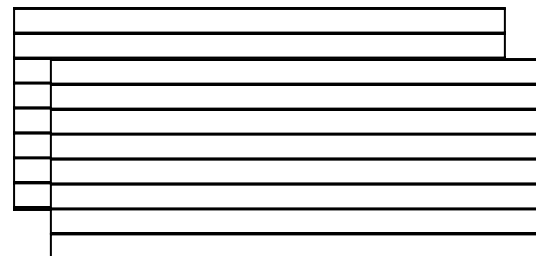

Roof 2 (qty. 2)

Read this entire manual thoroughly before proceeding with assembly.

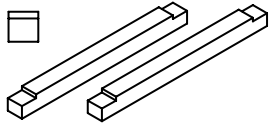

Bench support 1 (qty. 2)

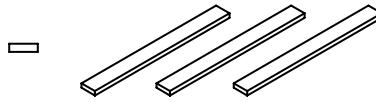

Backrest 2 vertical slat (qty. 3)

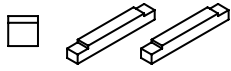

Bench support 2 (qty. 2)

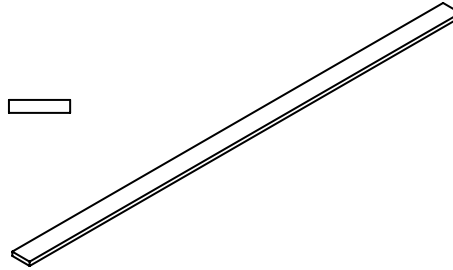

Cornice board 1 (qty. 1)

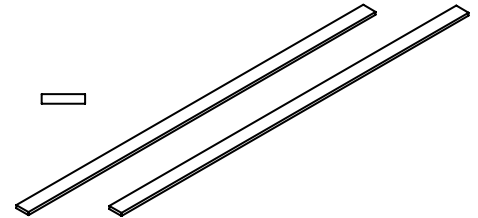

Front wall cover slat (qty. 2)

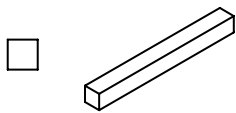

Side bench support 1 (qty. 1)

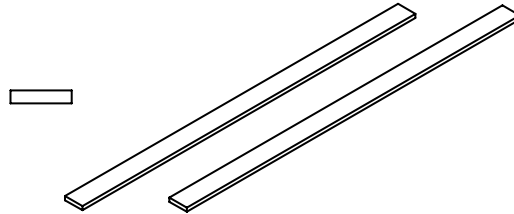

Cornice board 2 (qty. 2)

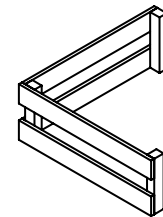

Heat fence (qty. 1)

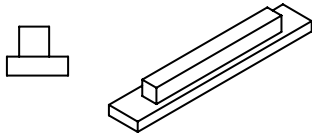

Side bench support 2 (qty. 1)

Screws	Qty.
4.5 x 80mm (.19" x 3.14")	8
4.5 x 70mm (.17" x 2.75")	47
4 x 60mm (.15" x 2.36")	8
4 x 50mm (.15" x 1.96")	50
3.5 x 40mm (.13" x 1.57")	28
3.5 x 35mm (.13" x 1.37")	6
3.5 x 25mm (.13" x .98")	9
3 x 20mm (.11" x .78")	16
Vent Cover Washer	1
Tenon	8

Tools required for assembly:

- Cordless drill
- Tape measure
- Rubber mallet
- Hammer
- 1/2" or 5/8" Forstner bit
- Utility knife
- Cordless screwdriver
- Screwdriver bits (Phillips & flathead)
- Level
- Step stool or ladder
- Framing square

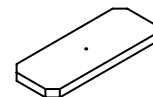

Vent cover (qty. 1)

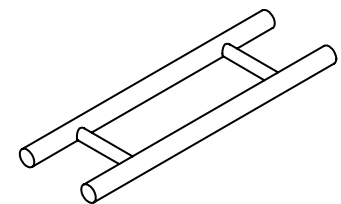

Door handle (qty. 1)

STEP 1.

Connect the Four Floor Risers

Fasten the four Floor Risers together using 4.5 x 80 screws. Be sure the two shorter boards are located on the sides and the two longer boards are on the front and back. Use a framing square to ensure that the assembly is square.

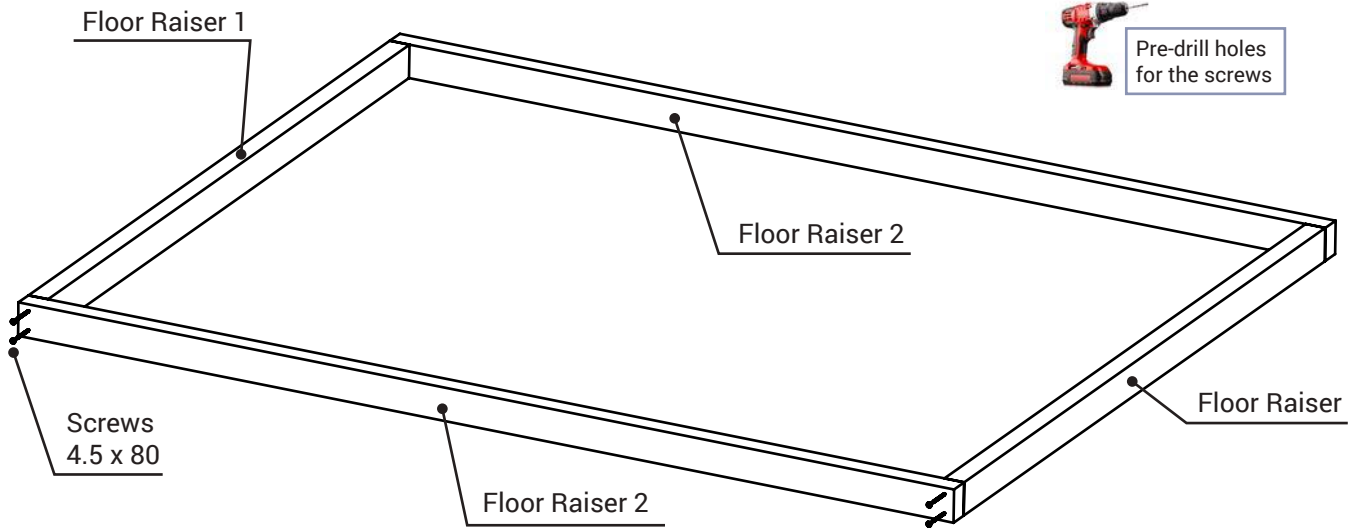



STEP 2.

Connect Wall Support Rails

Each wall support has a pre-drilled slot for the Tenon. Insert the Tenons in the longer support rail slots. Fasten the Wall Support Rails together and connect from corners using four 3 x 20 screws per corner.

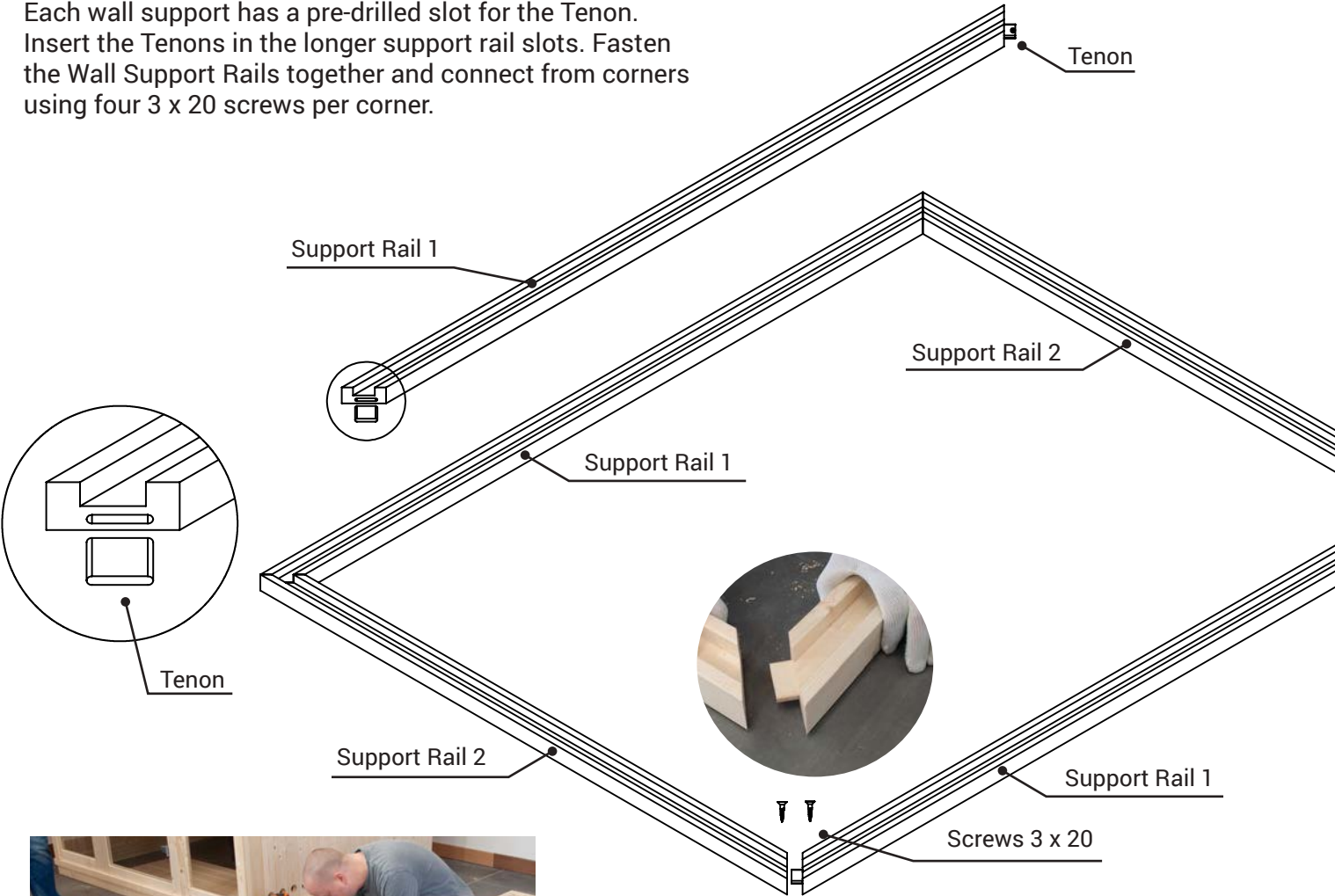

STEP 3.

Position Wall Support Rails

Lay the wall support rail assembly squarely on top of the floor risers with the groove facing up. The rails should overlap both sides of the riser by approximately 0.5". Secure the assembly to the floor risers using four 4 x 50 screws evenly spaced on each wall support rail.

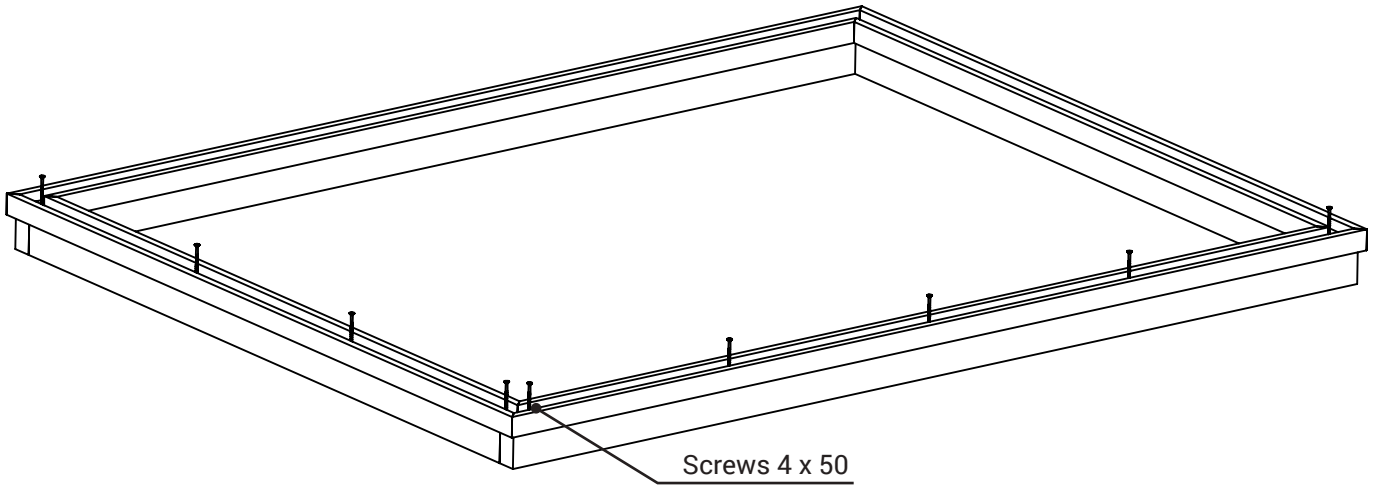

STEP 4.



Position Wall Sections (Back Wall 1 & Side Wall 1)

Position Back Wall 1 in the groove of the back rail and push it flush against the left rail. Have a helper hold the back wall section. Orient Side Wall Section 1 and place it in the groove of the left rail. Push the flat edge flush against back wall section. Align the two panels so they are flush and fasten them using 4.5 x 70 screws

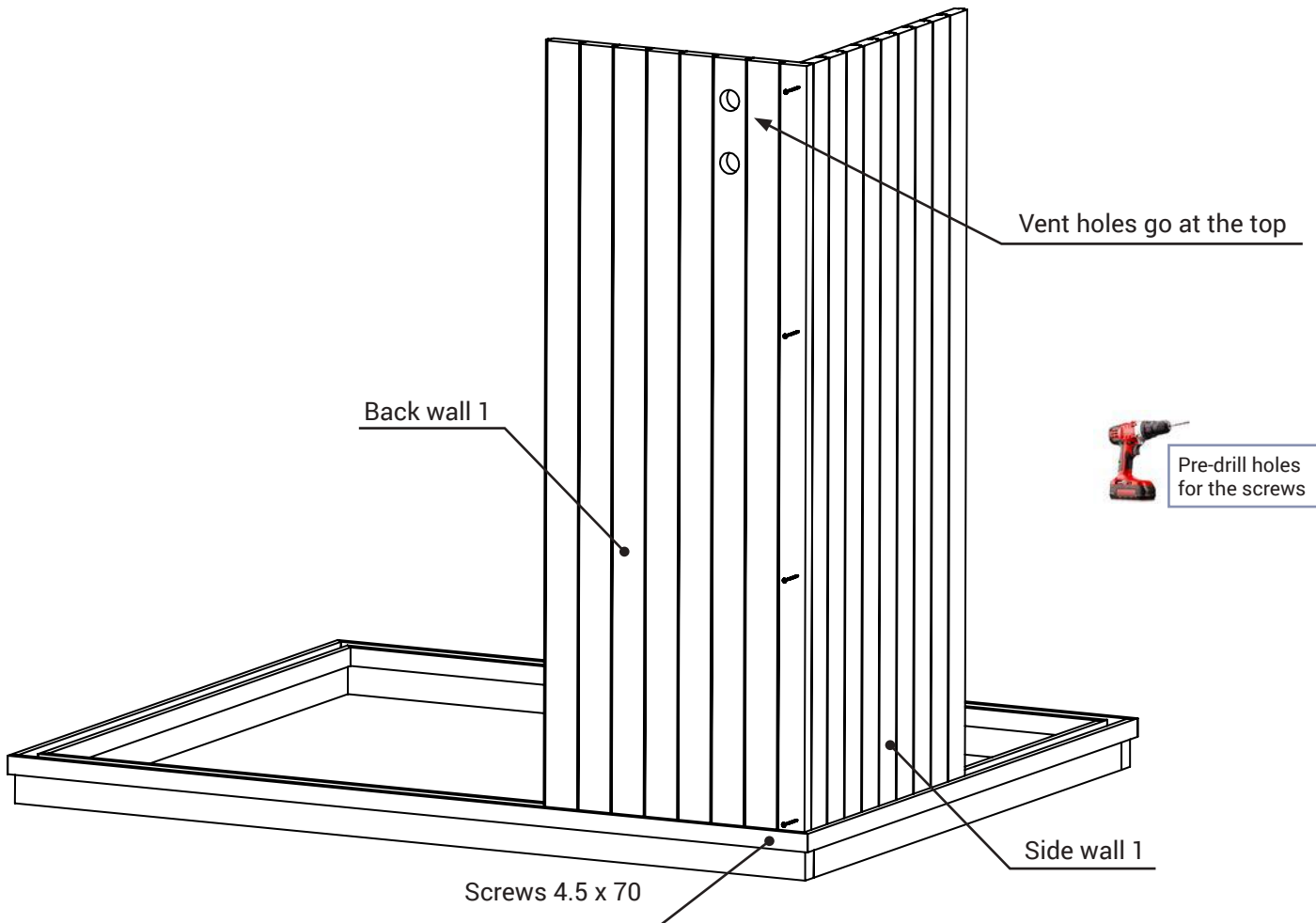



STEP 5.

Position Back Wall Sections 2 & 3, & Side Wall 1

Position Back Wall 2 section into the groove of the back rail. Attach it to Back Wall Section 1 by way of the tongue and groove fit. Secure it by tapping it into place with a rubber mallet. Repeat this step for wall section 3, again tapping it into place with a rubber mallet.

Position Side Wall Section 1 into the groove of the right side rail and push flush against the back wall. Be sure panels are flush with each other and fasten them together using the 4.5 x 70 screws.

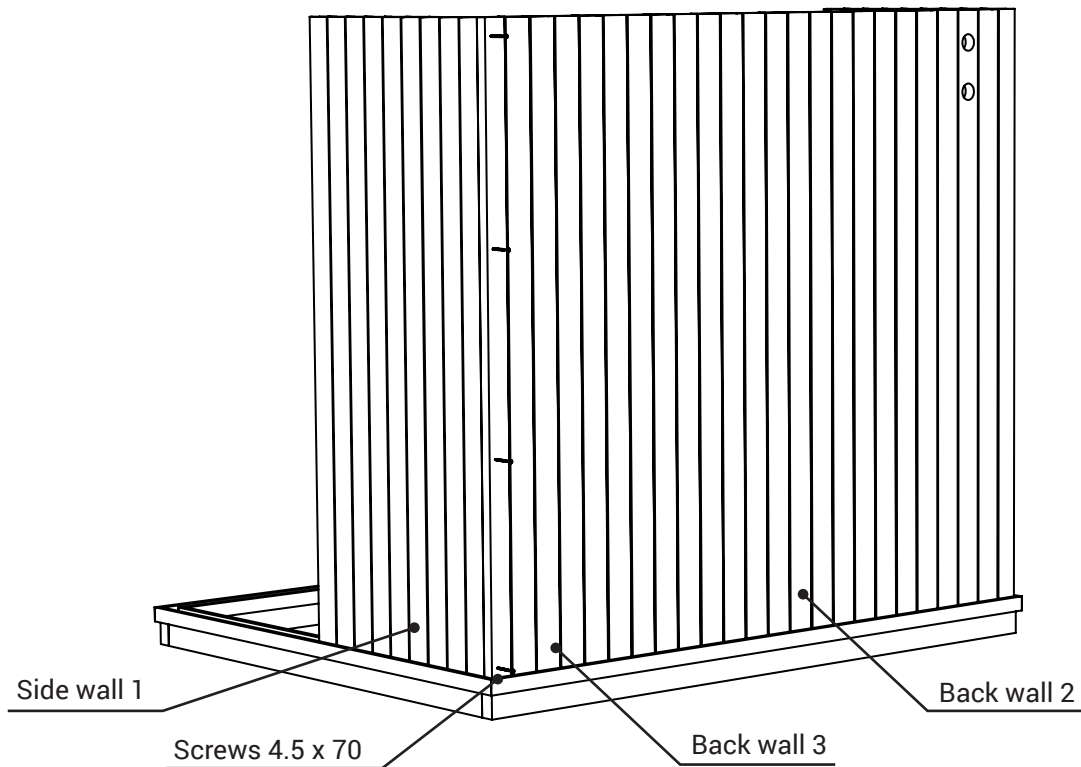



STEP 6.

Position Side Wall Section 2, Window Section & Door Element

Position Side Wall Section 2 into the groove of the side rail. Slide Side Wall Section 2 into place with Side Wall Section 1. Section 2 connects to Section 1 via tongue and groove so there is no need to use screws. Use a rubber mallet to secure the fit.

Place Window Section in the groove on the front rail and push against side rail. Being sure the two sections are flush, fasten them together using 4.5 x 70 screws.

Place Door Section onto the front rail orienting it so that the door opens according to your preference. Door Section connects to window section via tongue and groove so there is no need for screws. Gently tap it into place with a rubber mallet to secure the fit.

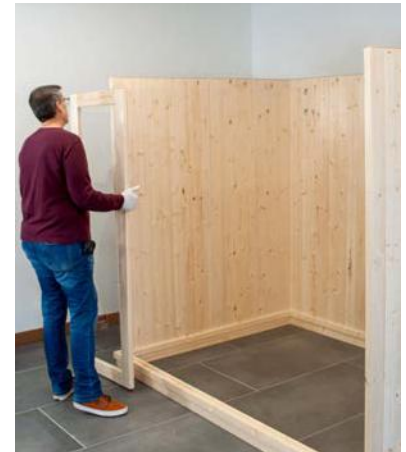
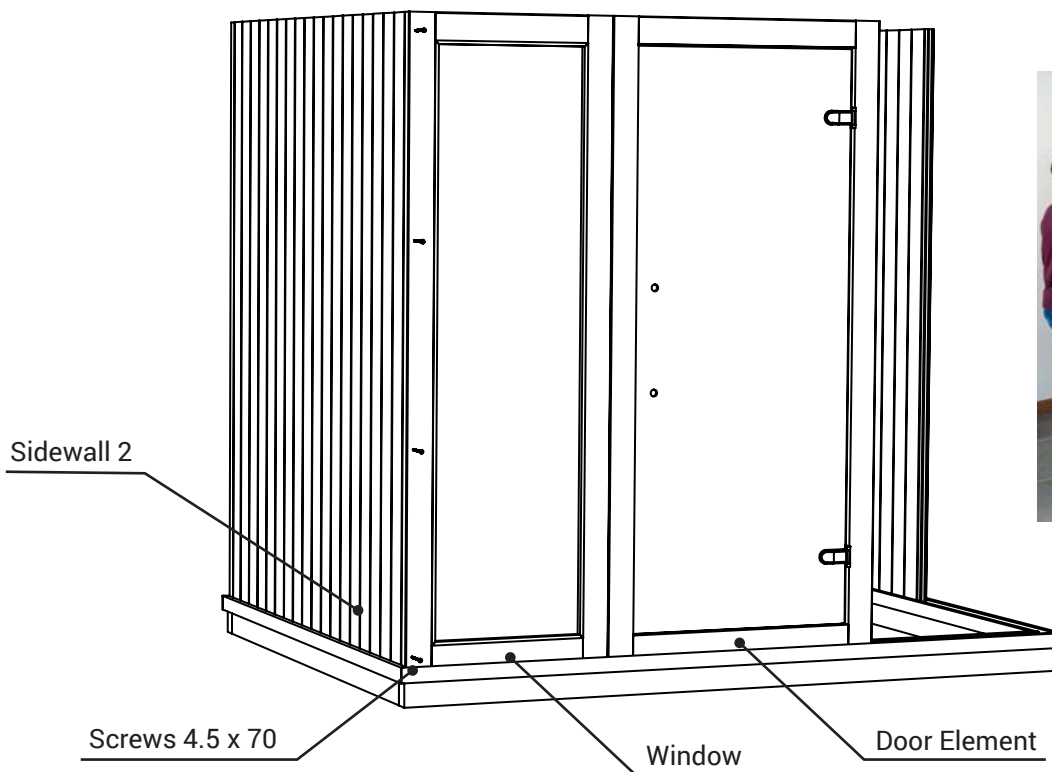

STEP 7.



Position Window Section & Side Wall Section 3

Position Side Wall Section 3 into the groove of the Side Rail orienting it so that the heater vent holes are located at the bottom. Slide the wall section into place with Side Wall section 1. Side Wall 3 connects to Side Wall 1 via tongue and groove so there is no need to use screws. Use a rubber mallet to secure the fit.

Next, place Window Section into the groove of the front rail and connect it to Door Section via the tongue & groove fit.

Gently tap into place with a rubber mallet to secure the fit. Now, making sure Window Section and Side Wall 3 are flush with each other, secure them together with the 4.5 x 70 screws.

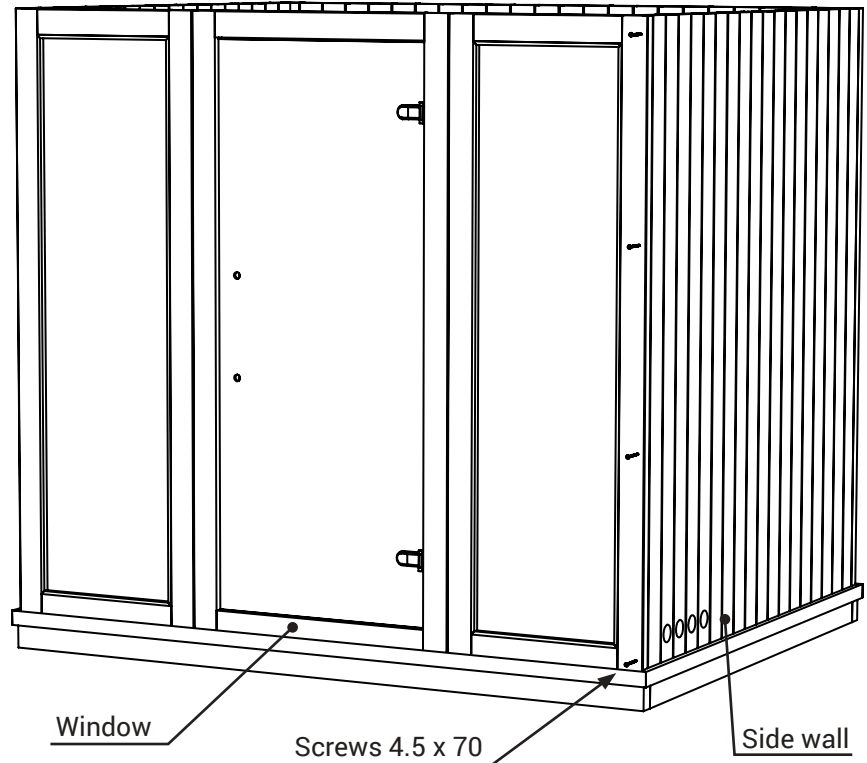



STEP 8.

Assemble & Position Roof Support Rails

Connect Roof Support Rails in the same way as Step 2. Place the assembly on top of the wall sections so that the wall sections fit snugly into the groove. When in place, secure to the assembly to the walls using four 4 x 50 screws on each rail.

Roof support rail

Screws 4.5 x 70

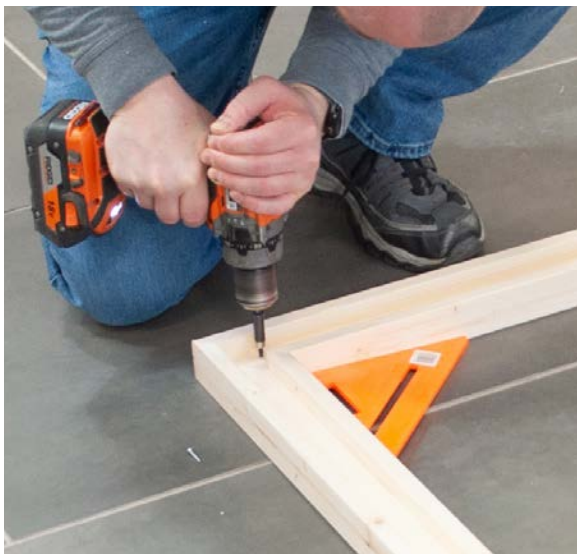
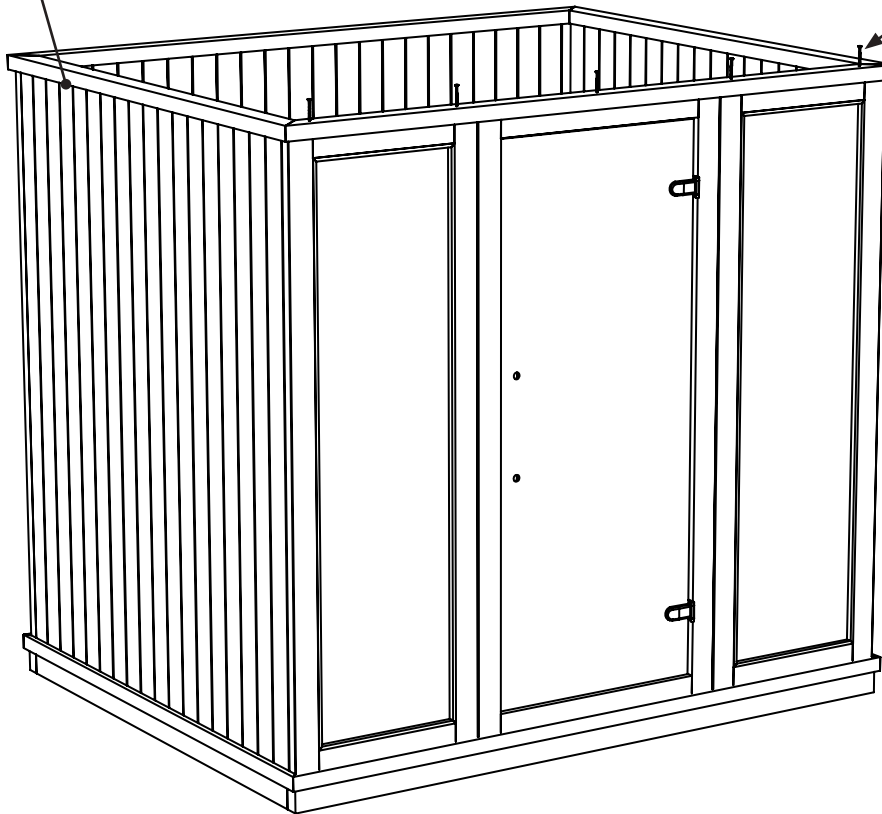

STEP 9.

Bench & Lower Bench Installation

Use 4.5 x 70 screws to connect the Bench Supports to the wall. Make sure the supports in both walls are the same height. When the supports are assembled, place the benches on the supports. Use three 4.5 x 70 screws to connect the Seat Bench to the Back Wall.

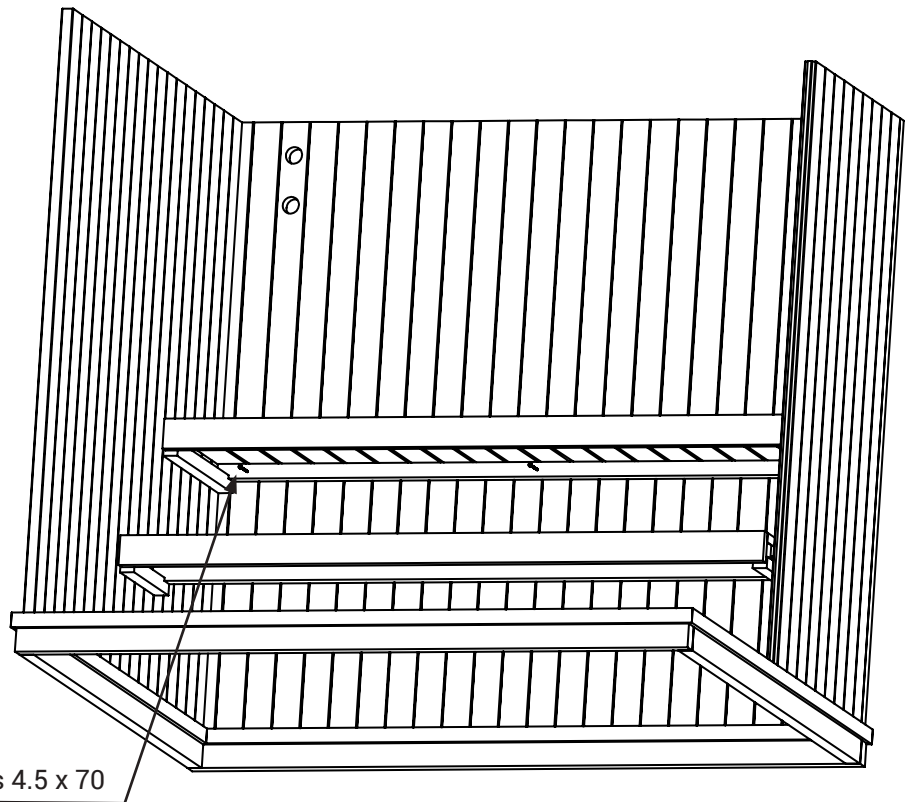
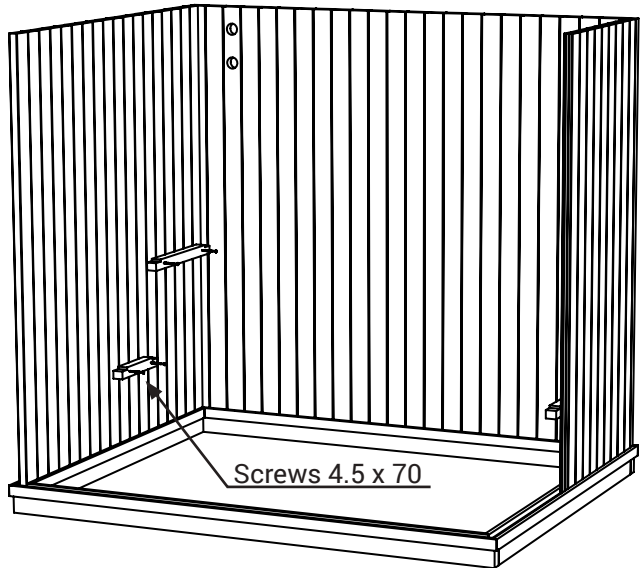
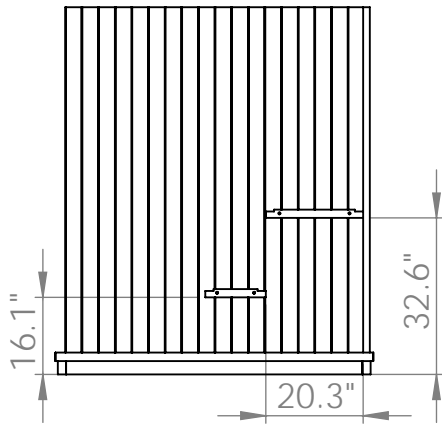

STEP 10.



Backrest Installation

Use 4.5 x 70 screws to connect the Bench Supports to the wall. Make sure the supports in both walls are the same height. When the supports are assembled, place the benches on the supports. Use three 4.5 x 70 screws to connect the Seat Bench to the Back Wall.

Step 1

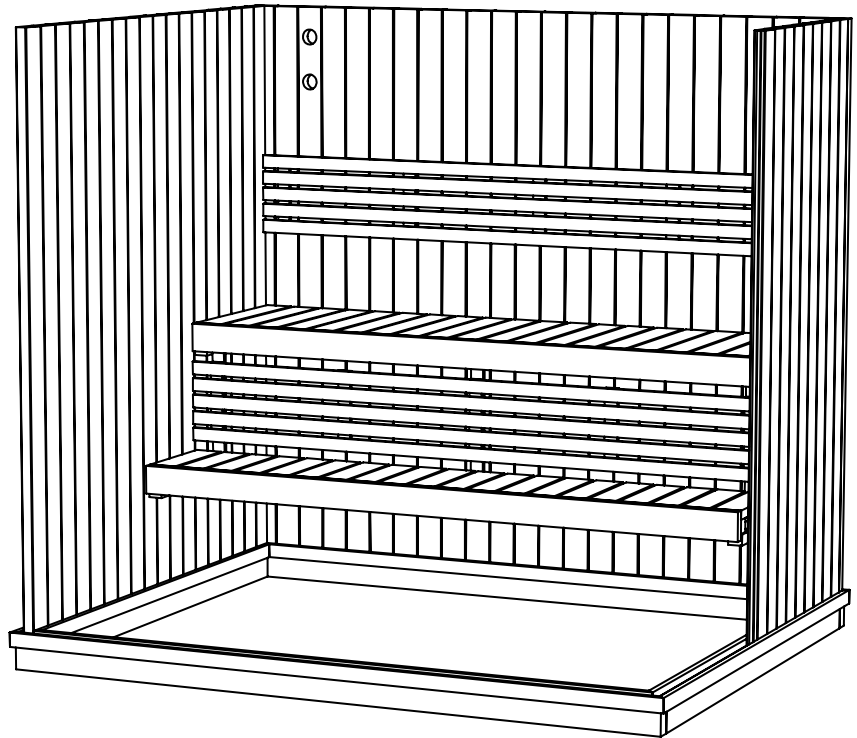
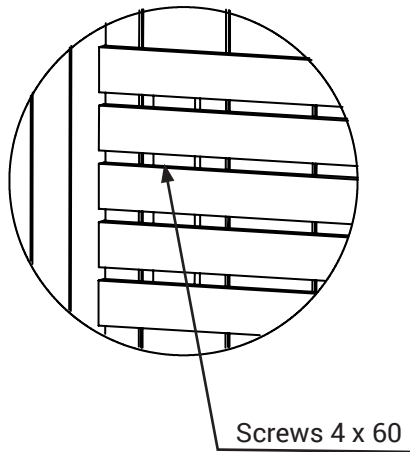

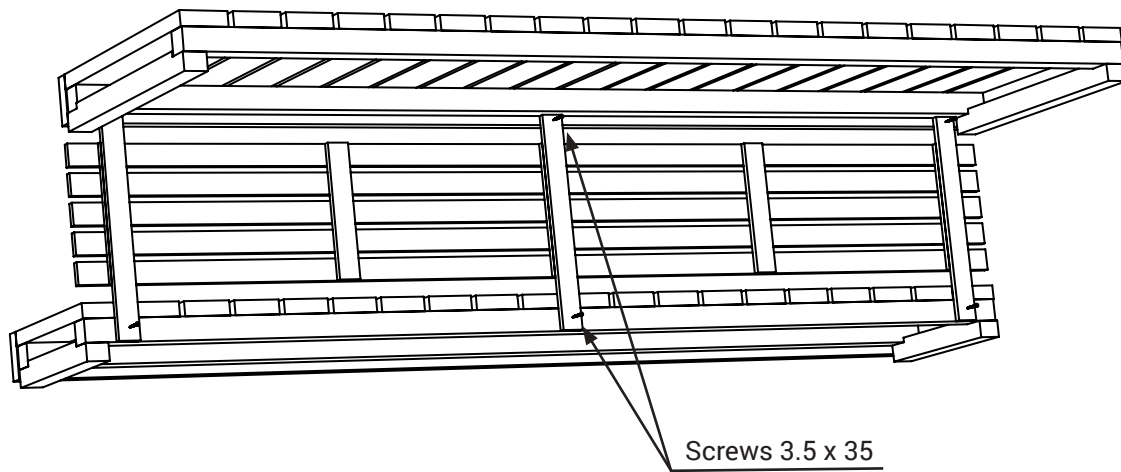
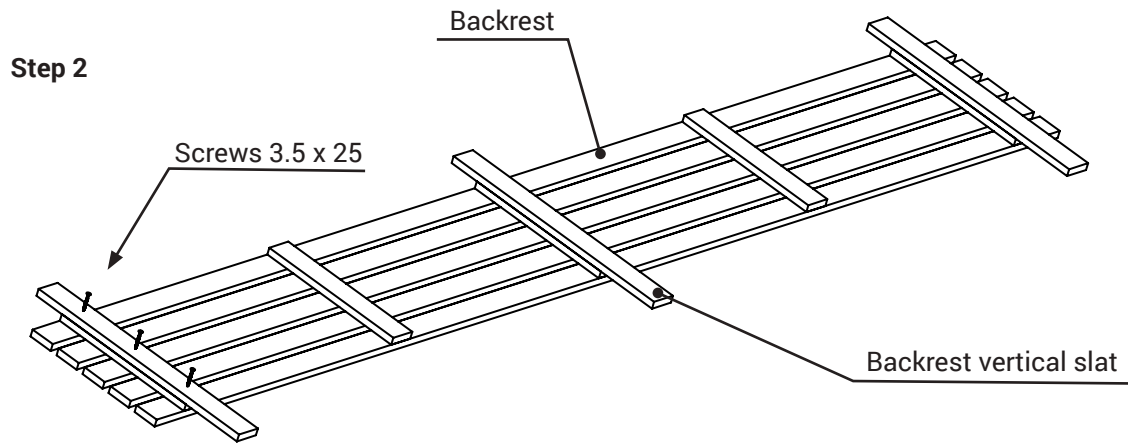



STEP 11.

Side Bench Installation

Attach the Side Bench Support 1 to the Lower Bench, using two 4.5 x 70 screws. The gap between the support and the side wall must be 2". Side Bench Support 2 connects to the window section using 4 x 60 screws. Support must be in the same height with lower bench. Place the Side Bench on the supports and fasten with two 4.5 x 70 screws to the side wall element.



Pre-drill holes for the screws

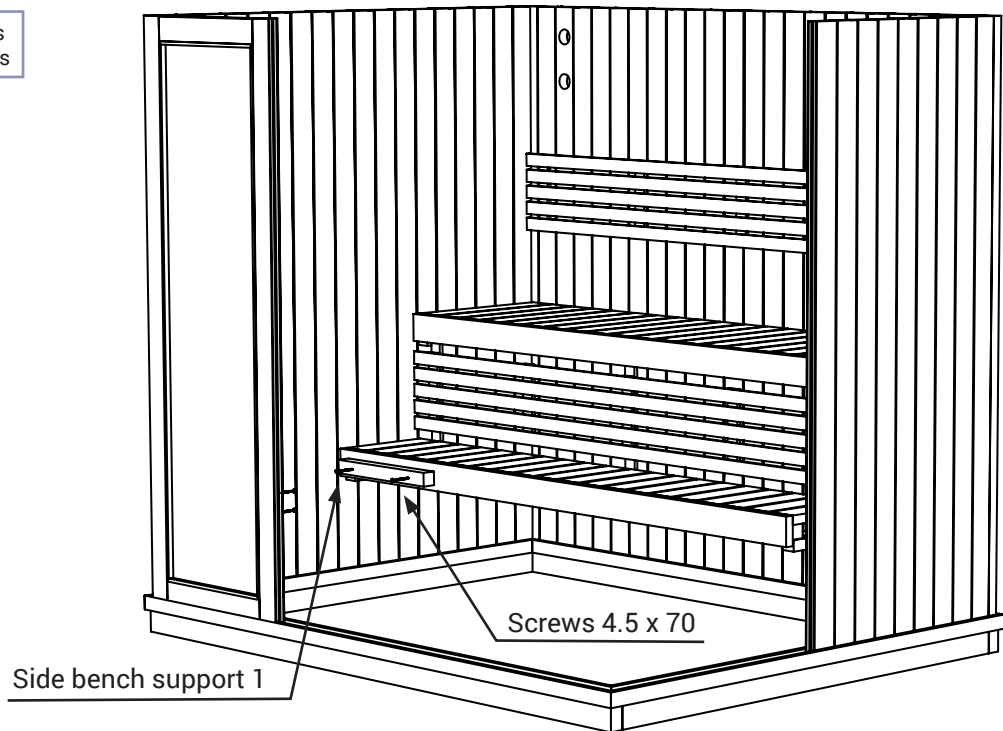

X7 Sauna Model
Installation & Owner's Manual

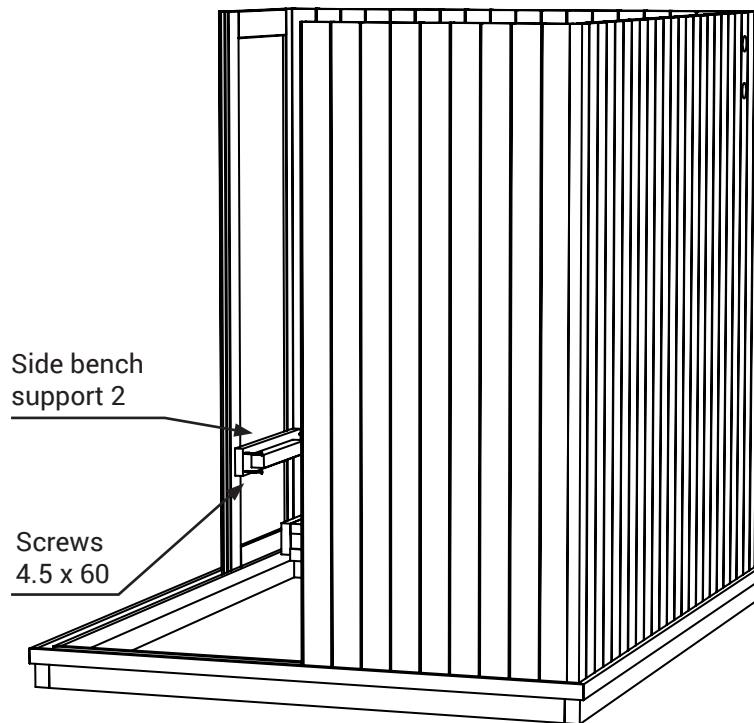
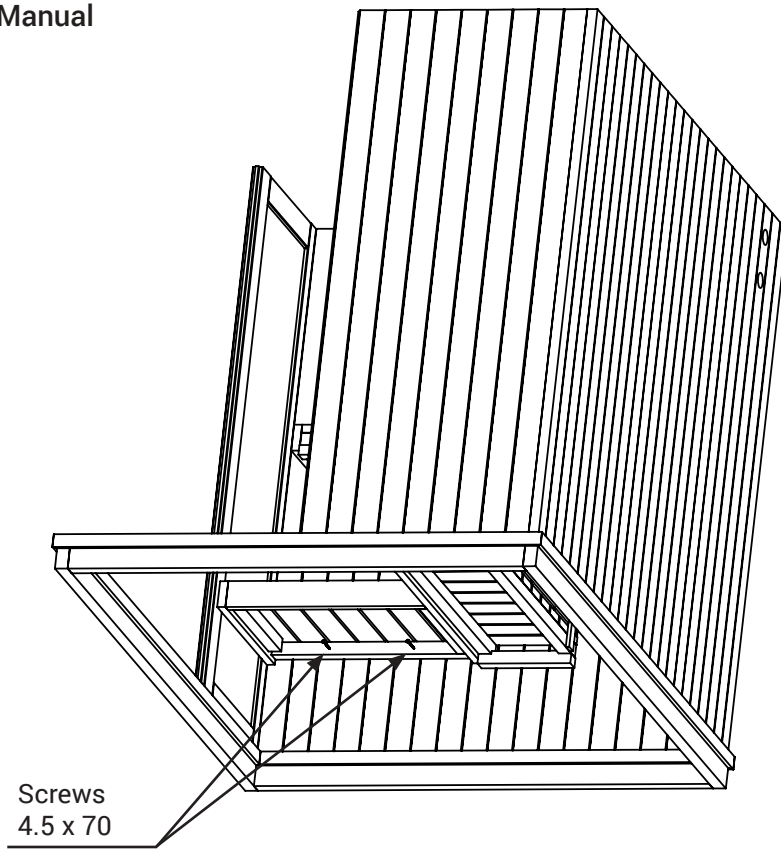

STEP 12. Position Roof Sections

Place the Roof Panels on top of the Ceiling Supports. Connect the sections via the tongue and groove fit. From the backside, roof panels must be in the same line with ceiling supports. Position both sides equally. Connect panels with 4 x 50 screws.

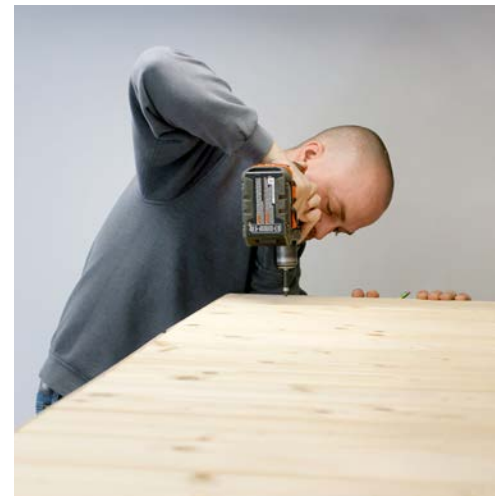
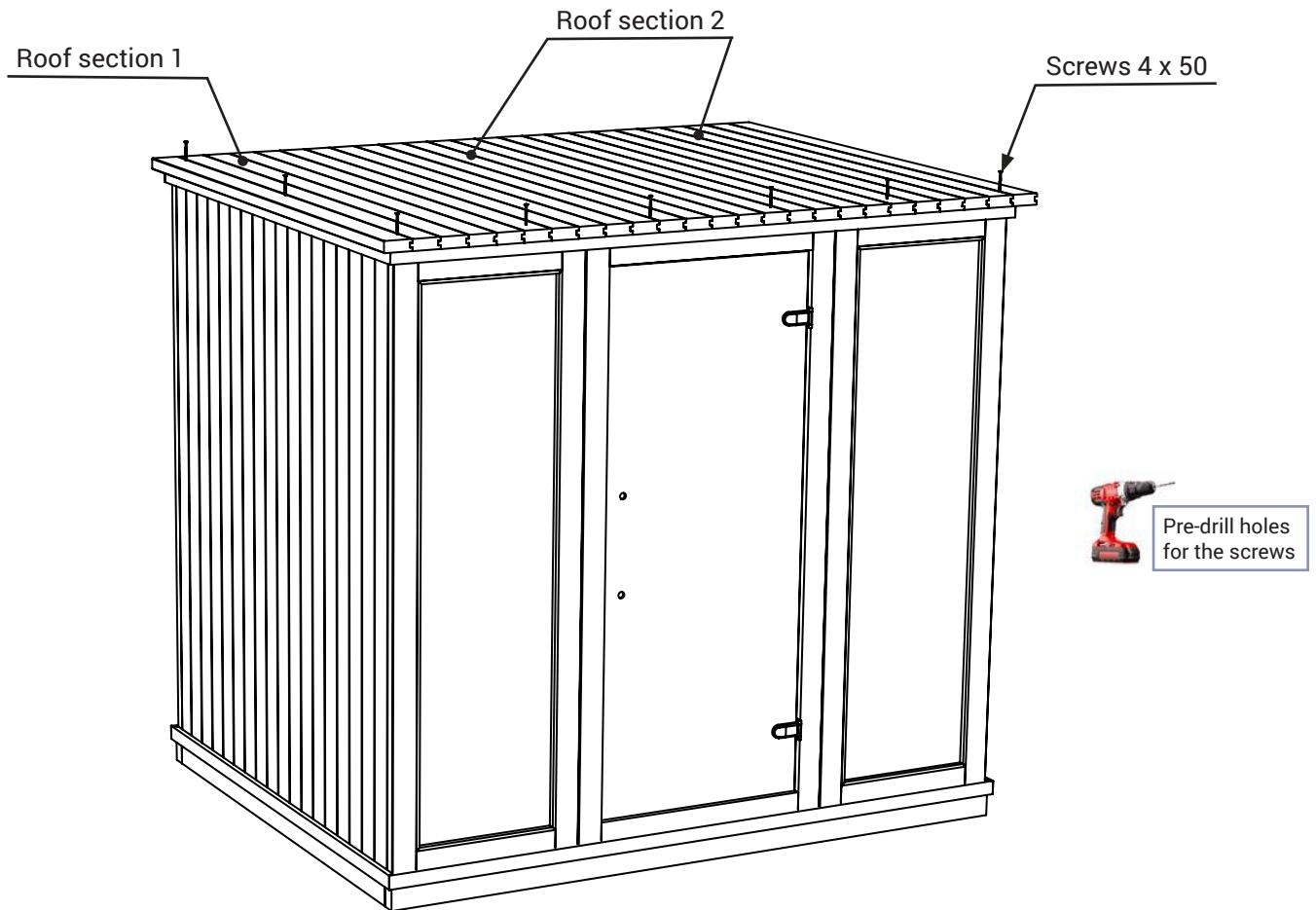

STEP 13.

Cornice Boards



Connect the cornice boards to the roof using 3.5 x 40 screws.

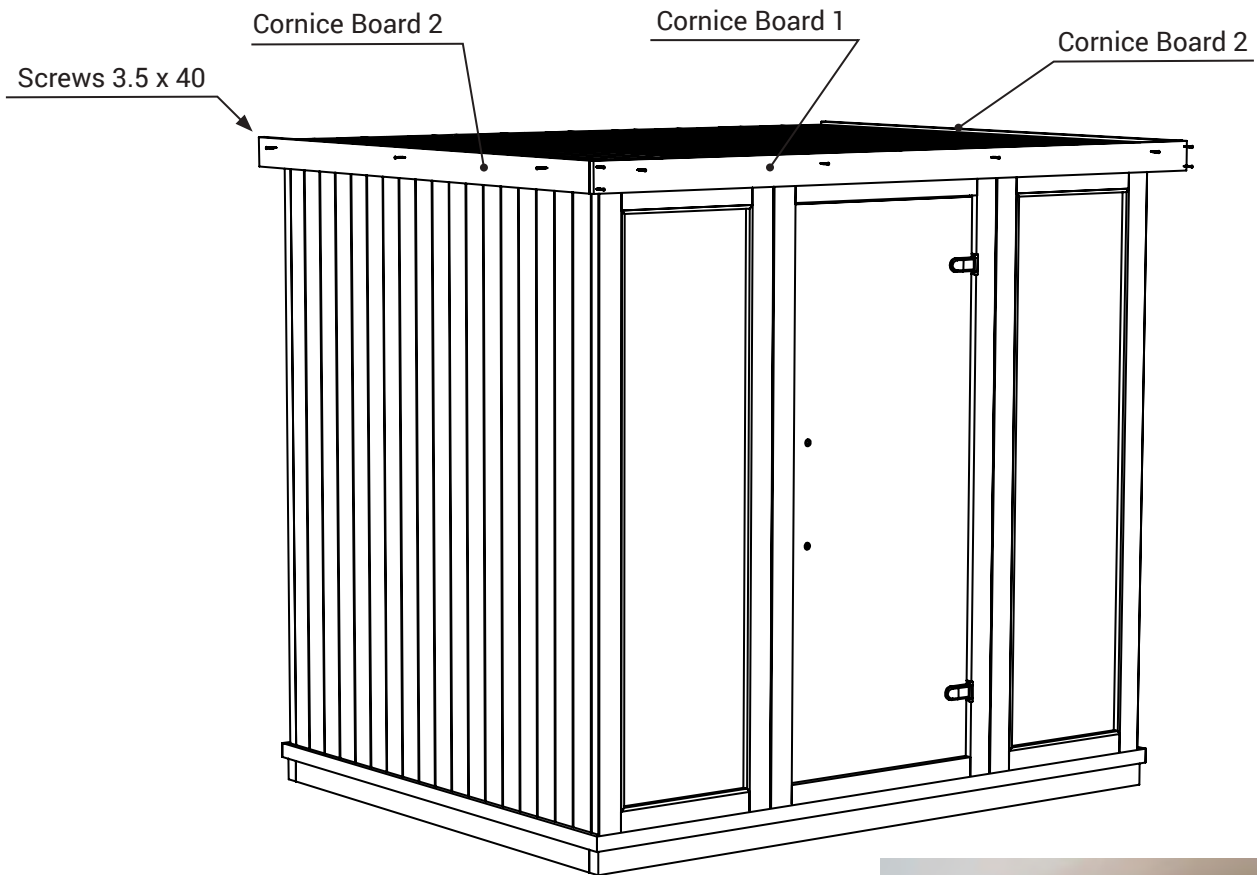



STEP 14.

Vent Cover & Door Handle

Connect vent cover with 3.5 x 40 screw. Add a small washer between the wall & vent cover.

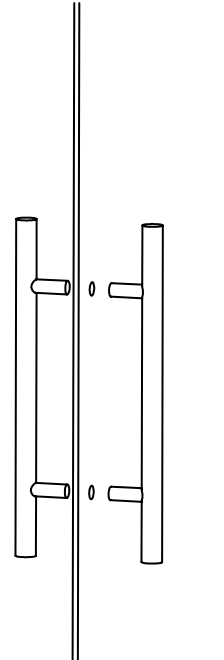
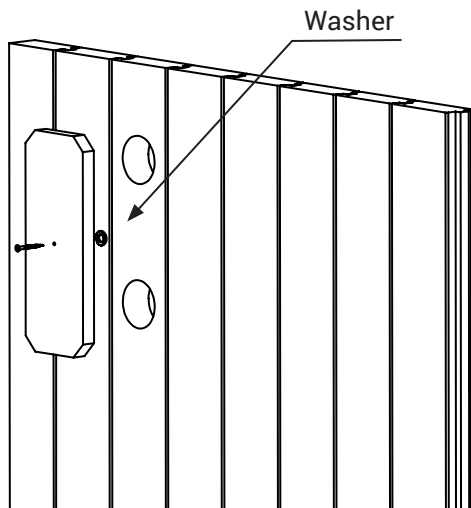



STEP 15.

Heater Fence

Connect the Heater Cover to the wall with 4 x 60 screws. Perform this step after heater is installed.



Pre-drill holes
for the screws

Note: Follow heater manufacturer recommended installation for heater guard.

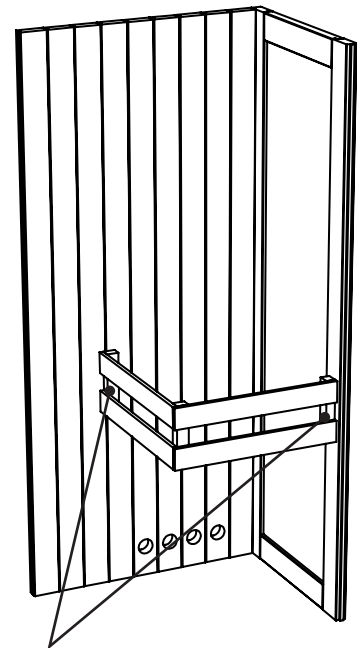

Screws
3.5 x 60

STEP 16.

Cover Slats for the Front Wall

Connect the Cover Slats
using 3.5 x 40 screws.

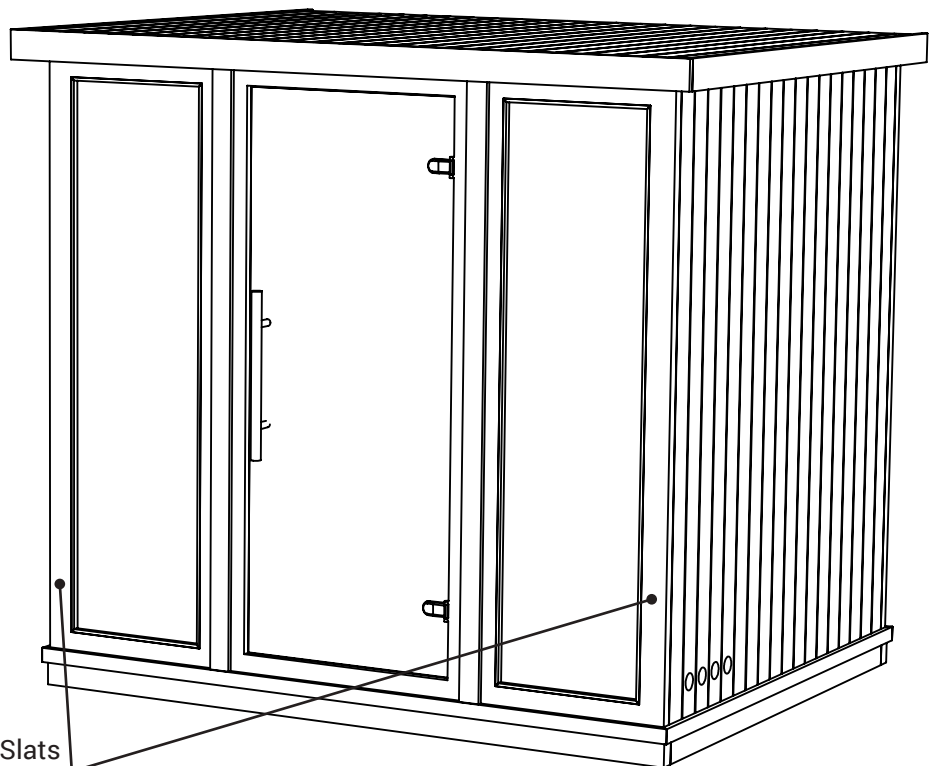

Cover Slats