

ecosmar<sup>+</sup><sup>TM</sup>  
Fire

# Welcome to EcoSmart Fire

EcoSmart Fire is the largest manufacturer of ethanol burners in the world, and our collection is the product of choice for many world-renowned architects and designers.

All EcoSmart Fireplaces are fitted with bioethanol burners. Our burners are available in many different shapes and sizes, and they hold a certain quantity of fuel. Depending on the size and model of the burner, it will produce more or less heat.

It is important to build a fundamental understanding on our ethanol burners to better understand our products, the design choices around them and how they work.

Generating this foundation knowledge will help you better service the many customers who prefer to create their own bespoke indoor and outdoor fireplaces.

# Bioethanol Burners

Our Burners can be installed just about anywhere and come in a range of shapes & sizes depending on the style wanting to be achieved.



# Collection

There are 9 ethanol burners in our collection, and they are split into 5 categories:

## XL Series



XL1200



XL900



XL700



XL500

## XS Series



XS340

## BK Series



BK5

## AB Series



AB8



AB3

## VB Series



VB2

All Black XL1200, XL900, XL700, XL500, AB8 & AB3 burners use a **“Porcelain Ceramic Enamel Coating”** this makes them incredibly durable, most notably it will not oxidise, corrode or discolour under heat.



# Included Accessories

The accessories shown below are included with every ethanol burner, ensuring safe operation and ease of use.



### 1. Jerry Can with (2.) Safety Spout

Jerry Can and Safety Spout safety features include automatic stop flow, fast flow rate, locking thumb button control, and self-venting system. Enables safe storage and decanting of e-NRG.

### 3. e-NRG bottle adaptor

The e-NRG bottle adaptor connects the safety spout from the Jerry Can straight onto the e-NRG bottle making fuelling the fire quicker and easier.



### 1. Lighting Rod

The Lighting Rod is designed to enable you to safely adjust the slider position on the Burner at any time. It is also used for the ignition procedure.

### 2. Lighter

The refillable butane Lighter supports the safe ignition of the lighting rod. The length of the lighter further enhances the management of the lighting process.



### Burner Top Tray

All Burners\* come with a "Top Tray", this is used as a second skin around the burner to allow the burner to expand and contract as it heats up/ cools down.

It will also catch any fuel that might accidentally be split when refilling the burner. (\*N/A for VB2).



### 1. XL Baffles (XL Burners only)

XL Baffles are placed over the internal burner vents and serve to increase the efficiency of the burner as well as further stabilise the flame.

### 2. Efficiency Ring (AB8 Burner only)

Placed over the burner mouth the Efficiency Ring increases the efficiency of the burner as well as further stabilising the flame.



### Jerry Can Spout Extension (AB3 Burner only)

This accessory is for use with models that have more restricted access to the filling point so that filling can be done in a safe manner

### Operating Manual

Includes complete assembly and operating instructions.



# Accessory Packaging

Important safety documents (including the lighter and lighting rod) are packaged together for safe keeping and safe operation.



Zip Lock Bag



Lighting Rod



Lighter



Operations Manual



Safety Check DL Card



e-NRG A5 Card

# XL Burner Series

## Specifications

The XL Burner Series refers to our “Extra Long” burners, they are generally more popular for indoor applications such as Firebox installations but can and are used in outdoor Fire Tables & bespoke constructions.









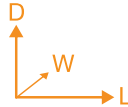

These models are the most expensive burners from our range, and they are the best sellers as well.

Linear fires are trendy, and customers looking for long flames will spend more to achieve a very elegant fireplace design using one of our extra long models.

Application: Indoor and Outdoor

Material: Grade 304 Stainless Steel

Colours available: Stainless Steel or Black

Burners	 Dimensions L x W x D (mm)	 Fuel Capacity	 Heats on Average (Indoors)	 Thermal Output Net (MAX)	 Approx. Burn Time	 Minimum Room Size (per burner)
<b>XL1200</b> 	L 1253 W 248 D 124	10 L [2.6 Gals]	Over 65m <sup>2</sup> [700ft <sup>2</sup> ]	17 MJ/h 15,290 BTU/h 4.5 kW	9 - 14 hours	115m <sup>3</sup> [4061ft <sup>3</sup> ]
<b>XL900</b> 	L 961 W 248 D 124	9 L [2.4 Gals]	Over 60m <sup>2</sup> [645ft <sup>2</sup> ]	16 MJ/h 15,000 BTU/h 4.4 kW	8 - 13 hours	110m <sup>3</sup> [3884ft <sup>3</sup> ]
<b>XL700</b> 	L 753 W 248 D 124	7 L [1.8 Gals]	Over 50m <sup>2</sup> [538ft <sup>2</sup> ]	14.5 MJ/h 13,650 BTU/h 4 kW	9 - 12 hours	90m <sup>3</sup> [3178ft <sup>3</sup> ]
<b>XL500</b> 	L 553 W 248 D 124	5 L [1.3 Gals]	Over 40m <sup>2</sup> [431ft <sup>2</sup> ]	12 MJ/h 11,430 BTU/h 3.35 kW	10 - 13 hours	80m <sup>3</sup> [2825ft <sup>3</sup> ]

# XL Burner Series

## Design and safety features

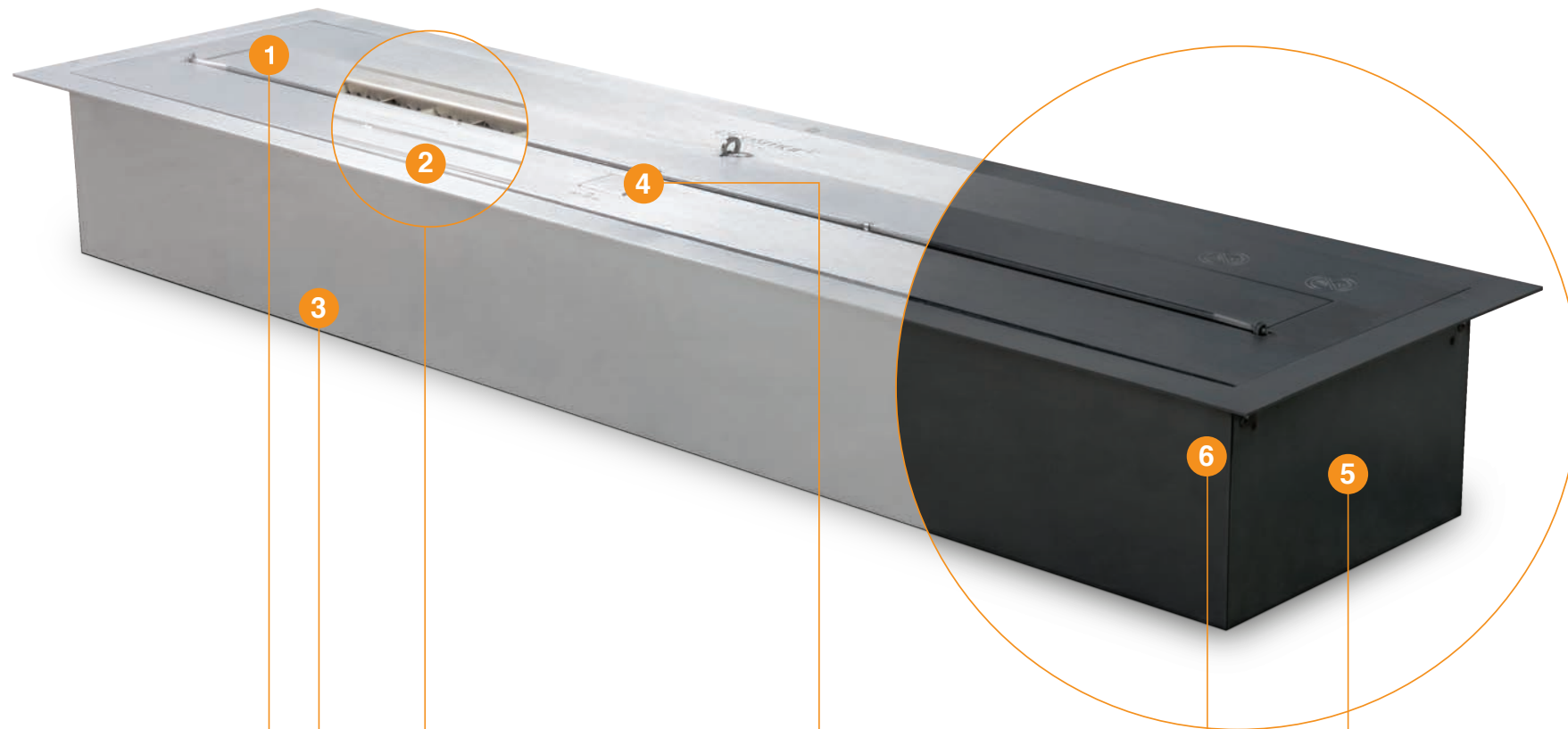

### 1. Flip Lid Shut Off System

The series' 'flip lid' shut-off system fits perfectly across the ignition zone to extinguish the flame and, when it is open, denies access to the separated filling point as a deterrent to filling the burner while it is in operation.

A reliable and safe extinguishing system courtesy of a special shut-off mechanism and precision measurements.

### 2. Flame Regulation

Purpose-designed XL Burner Baffles allow you to regulate and further stabilise the flame at the same time as increasing fuel efficiency of the burner.

### 3. High Quality

Crafted from high quality, 304 grade stainless steel inside and out, our burners are built to last a lifetime.

### 4. Dedicated Filling Point

A patented filling point is separated from the ignition zone and engineered so that the jerry can spout is fully supported prior to releasing the fuel supply. This eliminates the usual splash and spills that would otherwise occur when fuel is decanted into the burner while simultaneously reinforcing the maximum fill line within the burner.

### 6. Top Tray

The Top Tray protects against heat transference and aids in the collection of accidental spillage.

### 5. Colour

Available in Stainless Steel and Black.

All black burners use a "Porcelain Ceramic Enamel Coating". The black coating makes them incredibly durable, most notably it will not oxidize, corrode or discolour under heat and it has a great tolerance to natural solvents.

### Global Compliance

All burners are UL Listed in accordance with ANSI/UL1370 in the USA, Certified by BSI in accordance with EN16647, and comply with the ACCC Safety Mandate for Australia.

### Deep-drawn Fabrication

All burners are constructed through a "deep-drawn" process, this ensures there are no welding lines or seams through the constructions which could deteriorate over time or come with "pinhole" leaks.

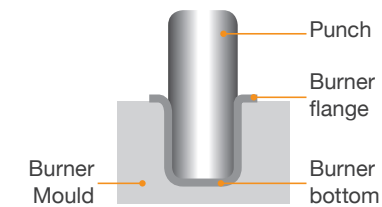

## Included Accessories



Jerry Can with Safety Spout & e-NRG bottle adaptor



Lighting Rod & Lighter



Top Tray



XL Baffles



# XL Burner Series

## Installation Examples



# XS Burner Series

## Specifications







There is only 1x burner in this collection, the “Extra Small” ethanol burner. The XS340 burner is used for smaller spaces or tighter firebox installations.

**XS340 is the smallest linear burner we offer with the same sized tank as an AB3 burner but with a lower burn time due to its larger mouth.**

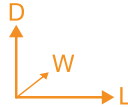
Application: Indoor and Outdoor

Material: Grade 304 Stainless Steel

Colours available: Stainless Steel or Black

Burner	 Dimensions L x W x D (mm)	 Fuel Capacity	 Heats on Average (Indoors)	 Thermal Output Net (MAX)	 Approx. Burn Time	 Minimum Room Size (per burner)
<b>XS340</b> 	L 382 W 232 D 107	2.5 L [0.7 Gals]	Over 20m <sup>2</sup> [215ft <sup>2</sup> ]	8.93 MJ/h 8,530 BTU/h 2.5 kW	5 hours	45m <sup>3</sup> [1589ft <sup>3</sup> ]



# XS Burner Series

## Design and safety features

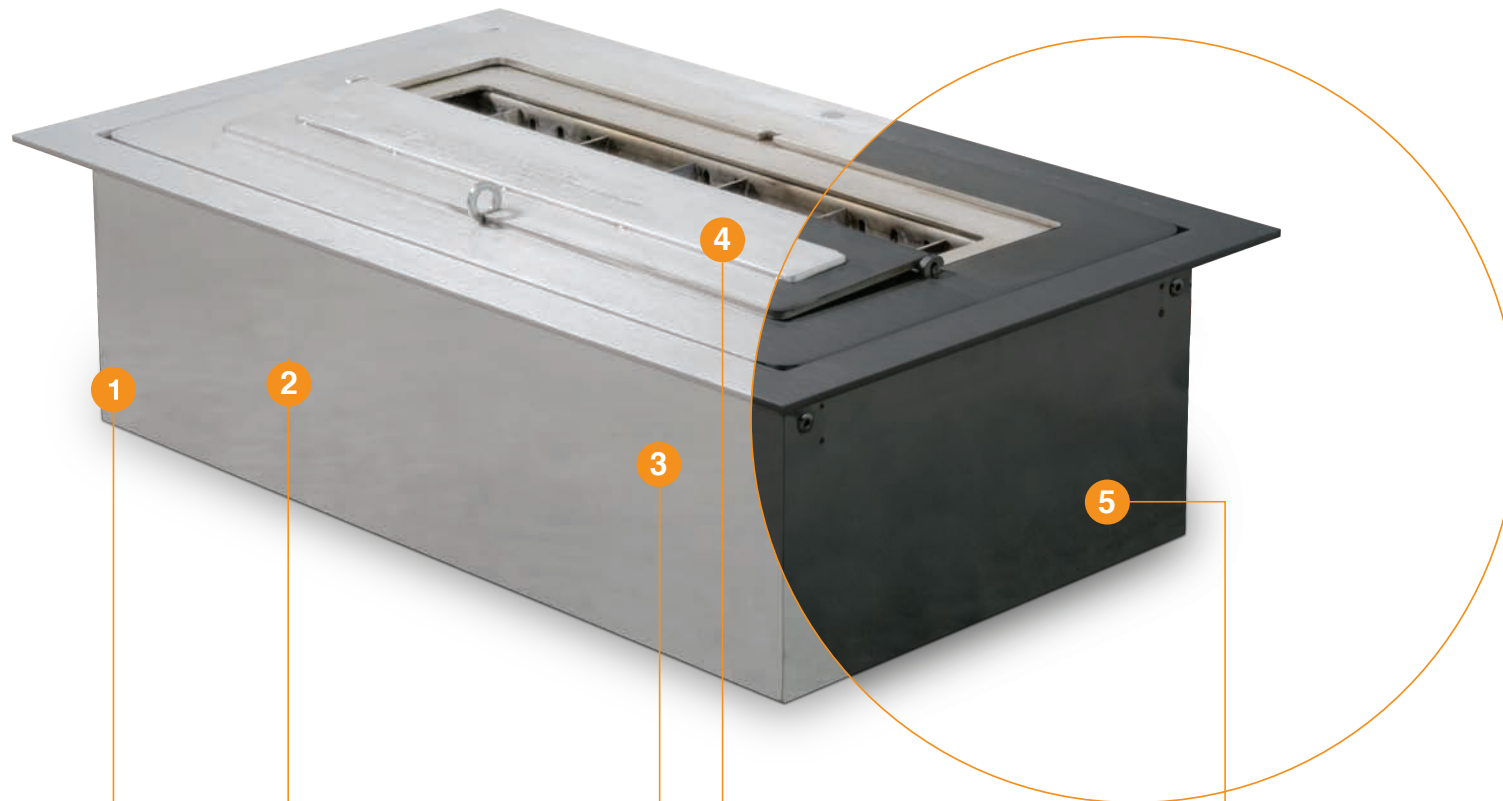

### 1. Signature Style

Clever design and compact size enable the XS340 to be incorporated into smaller or recessed spaces. Indoor or out, the choice is yours.

### 2. High Quality

Crafted from high quality, 304 grade stainless steel inside and out, our burners are built to last a lifetime.

### 3. Top Tray

The Top Tray protects against heat transference and aids in the collection of accidental spillage.

### 4. Flip Lid Shut Off System

The series' 'flip lid' shut-off system fits perfectly across the ignition zone to extinguish the flame and, when it is open, denies access to the separated filling point as a deterrent to filling the burner while it is in operation.

A reliable and safe extinguishing system courtesy of a special shut-off mechanism and precision measurements.

### 5. Colour

Available in Stainless Steel and Black.

All black burners use a "Porcelain Ceramic Enamel Coating". The black coating makes them incredibly durable, most notably it will not oxidize, corrode or discolour under heat and it has a great tolerance to natural solvents.

### Global Compliance

All burners are UL Listed in accordance with ANSI/UL1370 in the USA, Certified by BSI in accordance with EN16647, and comply with the ACCC Safety Mandate for Australia.

### Deep-drawn Fabrication

All burners are constructed through a "deep-drawn" process, this ensures there are no welding lines or seams through the constructions which could deteriorate over time or come with "pinhole" leaks.

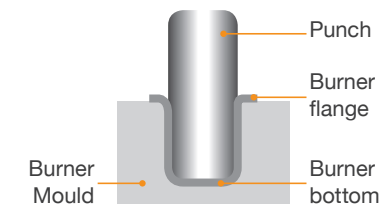

### Included Accessories



Jerry Can with Safety Spout & e-NRG bottle adaptor



Lighting Rod & Lighter



Top Tray



# XS Burner Series

## Installation Examples











# BK Burner Series

## Specifications

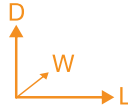
The “BK5 Burner Kit” is the only square burner in our collection.

The flame height and heat output can be adjusted during operation using the sliding lid. This sliding mechanism is the key selling feature of this burner.

Application: Indoor and Outdoor  
 Material: Grade 304 Stainless Steel  
 Colour: Stainless Steel only

Burner	 Dimensions L x W x D (mm)	 Fuel Capacity	 Heats on Average (Indoors)	 Thermal Output Net (MAX)	 Approx. Burn Time	 Minimum Room Size (per burner)
<b>BK5</b> 	L 400 W 317 D 123	5 L [1.3 Gals]	Over 35m <sup>2</sup> [376.7ft <sup>2</sup> ]	14 MJ/h 13,000 BTU/h 3.5 kW	7 - 11 hours	70m <sup>3</sup> [2472ft <sup>3</sup> ]

# BK Burner Series

## Design and safety features



### 1. Safe Filling

Perfectly aligned slider mechanism, filling point and fuelling system that allows an unobstructed view of the burner tank. This ensures the burner is not filled above the maximum capacity line.

An additional safety measure that prevents the filling point from being accessed while the slider is open. This ensures the flame is fully extinguished before the burner can be refuelled.

### 2. Dedicated Filling Point

A patented filling point is separated from the ignition zone and engineered so that the jerry can spout is fully supported prior to releasing the fuel supply. This eliminates the usual splash and spills that would otherwise occur when fuel is decanted into the burner while simultaneously reinforcing the maximum fill line within the burner.

### 3. Flame Regulation

Easy flame control that allows you to regulate the amount of heat being generated, and therefore the amount of fuel consumed. This results in a highly economical and efficient burner.

### 4. High Quality

Crafted from high quality, 304 grade stainless steel inside and out, our burners are built to last a lifetime.

### 5. Colour

Available in Stainless Steel only.

### 6. Top Tray

The Top Tray protects against heat transference and aids in the collection of accidental spillage.

### Global Compliance

All burners are UL Listed in accordance with ANSI/UL1370 in the USA, Certified by BSI in accordance with EN16647, and comply with the ACCC Safety Mandate for Australia.

### Deep-drawn Fabrication

All burners are constructed through a “deep-drawn” process, this ensures there are no welding lines or seams through the constructions which could deteriorate over time or come with “pinhole” leaks.

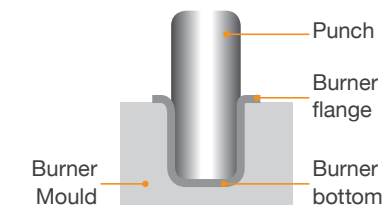

## Included Accessories



Jerry Can with Safety Spout & e-NRG bottle adaptor



Lighting Rod & Lighter



Top Tray



# BK Burner Series

## Installation Examples





# AB Burner Series

## Specifications







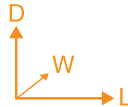

The AB Burner Series is our most popular burner collection for outdoor applications due to its water-resistant lid design and huge vibrant circular flame.

The fuel capacity and heat output are the key differences between the two burners; both AB8 and AB3 burners offer a similar burn time.

Application: Indoor and Outdoor

Material: Grade 304 Stainless Steel

Colours: Stainless Steel or Black

Burners	 Dimensions L x W x D (mm)	 Fuel Capacity	 Heats on Average (Indoors)	 Thermal Output Net (MAX)	 Approx. Burn Time	 Minimum Room Size (per burner)
<b>AB8</b> 	L 402 W 402 D 159	8 L [2.1 Gals]	Over 60m <sup>2</sup> [645ft <sup>2</sup> ]	21.56 MJ/h 20,433 BTU/h 5.99 kW	7 - 11 hours	116m <sup>3</sup> [4096ft <sup>3</sup> ]
<b>With Efficiency Ring</b>			Over 30m <sup>2</sup> [322.9ft <sup>2</sup> ]	13.9 MJ/h 12,860 BTU/h 3.77kW	9 - 11 hours	
<b>AB3</b> 	L 291 W 291 D 101	2.5 L [0.7 Gals]	Over 20m <sup>2</sup> [215ft <sup>2</sup> ]	6.14 MJ/h 5,800 BTU/h 1.7 kW	8 - 11 hours	40m <sup>3</sup> [1413ft <sup>3</sup> ]



# AB Burner Series

## Design and safety features



### 1. Dual Function Lid

A simple lid is used to extinguish the flame and cover the burner opening when it is not in use. This prevents dust particles, leaf litter, rain and debris from falling into the 304 grade stainless steel tank, leaving it clean and safe for use year round.

### 2. Efficiency Ring

The Efficiency Ring is placed over the internal burner vents when cold and not operating and serve to increase the efficiency of the burner as well as further stabilise the flame of the burner.

### 3. Top Tray

The Top Tray protects against heat transference and aids in the collection of accidental spillage.

### 4. Dedicated Filling Point

A designated, in-built filling point to ensure the same procedures can be followed to decrease the likelihood of overfilling.

### 5. High Quality

Crafted from high quality, 304 grade stainless steel inside and out, our burners are built to last a lifetime.

### 6. Colour

Available in Stainless Steel and Black.

All black burners use a “Porcelain Ceramic Enamel Coating”. The black coating makes them incredibly durable, most notably it will not oxidize, corrode or discolour under heat and it has a great tolerance to natural solvents.

### Global Compliance

All burners are UL Listed in accordance with ANSI/UL1370 in the USA, Certified by BSI in accordance with EN16647, and comply with the ACCC Safety Mandate for Australia.

### Deep-drawn Fabrication

All burners are constructed through a “deep-drawn” process, this ensures there are no welding lines or seams through the constructions which could deteriorate over time or come with “pinhole” leaks.

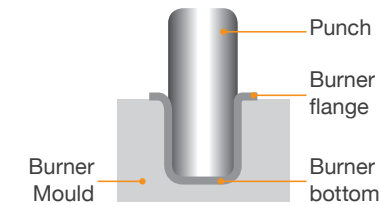

## Included Accessories



Jerry Can with Safety Spout & e-NRG bottle adaptor



Lighting Rod & Lighter



Top Tray



Efficiency Ring (AB8 Burner only)



Jerry Can Spout Extension (AB3 Burner only)



# AB Burner Series

## Installation Examples





# VB Burner Series

## Specifications

The VB2 “Victorian Burner” is specially designed as a “drop-in’ burner to retrofit into existing or new Edwardian or Victorian Cast iron Fireplaces.







The VB2 burner is the smallest fuel tank in our collection (2L) and heats up to 15m<sup>2</sup>.

A3 cut out is available for customers to confirm the burner fits their grate.

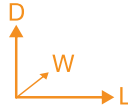
Application: Indoor Only

Material: Black Powder-coated Grade 304 Stainless Steel

Colours: Black

Burner	 Dimensions L x W x D (mm)	 Fuel Capacity	 Heats on Average (Indoors)	 Thermal Output Net (MAX)	 Approx. Burn Time	 Minimum Room Size (per burner)
<b>VB2</b> 	L 330 W 110 D 102	2 L [0.5 Gals]	Over 15m <sup>2</sup> [161ft <sup>2</sup> ]	7.24 MJ/h 6,180 BTU/h 2.5 kW	6 hours	45m <sup>3</sup> [1589ft <sup>3</sup> ]

# VB Burner Series

## Design and safety features

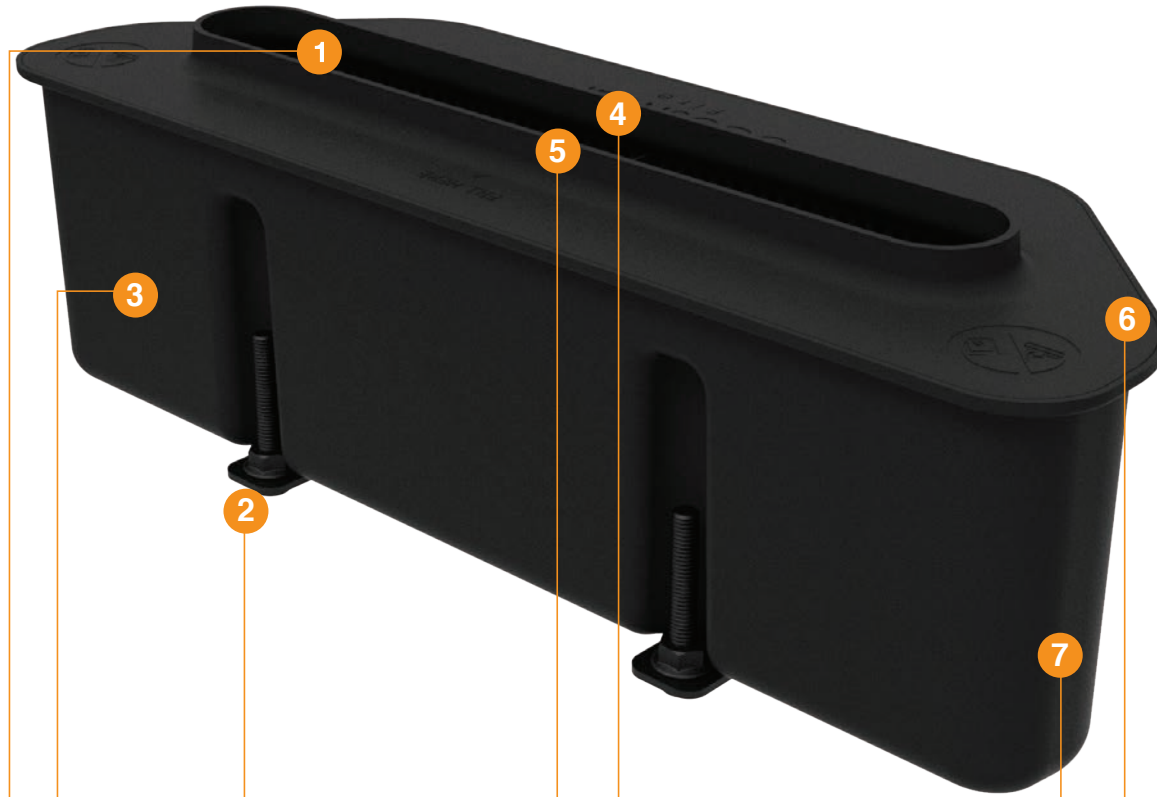

### 1. Dual Function Lid

A simple lid is used to extinguish the flame and cover the burner opening when it is not in use. This prevents dust from falling into the tank, leaving it clean and safe for use year round.

### 2. Height Adjustable

Adjustable feet level and lift the burner to the best setting depending on the depth of the grill it's being placed within.

### 3. High Quality

Crafted from high quality, 304 grade stainless steel inside and out, our burners are built to last a lifetime.

### 4. Dedicated Filling Point

A designated, in-built filling point to ensure the same procedures can be followed to decrease the likelihood of overfilling.

### 5. Accessory Exclusion Zone

Elevated lip around the burner mouth that stops accessories from sitting over the flame or blocking the shut off procedure. This raised lip includes air holes that allows air to flow smoothly around the fuel to achieve a better flame within the setting.

### 6. Colour

Available in Black only.

### 7. Fuel Efficiency

The burner has several layers of internal features that increases its efficiency including vertical baffles, aspiration vents and dense padding - all of which is built to last a lifetime.

### Global Compliance

All burners are UL Listed in accordance with ANSI/UL1370 in the USA, Certified by BSI in accordance with EN16647, and comply with the ACCC Safety Mandate for Australia.

### Deep-drawn Fabrication

All burners are constructed through a "deep-drawn" process, this ensures there are no welding lines or seems through the constructions which could deteriorate over time or come with "pinhole" leaks.

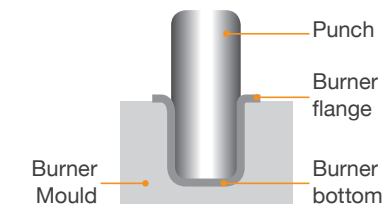

### Included Accessories



Jerry Can with Safety Spout & e-NRG bottle adaptor



Lighting Rod & Lighter







# VB Burner Series

## Installation Examples



# Ventilation & Efficiency

					
Burner	Fuel Capacity	Approx. Burn Time	Thermal Output Net	Heats on Average	Minimum Room Size
	<p>Capacity is the number of litres that will fit in each burner, every burner has a maximum capacity.</p> <ul style="list-style-type: none"> <li>• Each burner has a “fill” line when you open the lid to indicate maximum capacity.</li> <li>• Note that the capacity for most burners is also the number in the name, this may make it easier to remember. Example: XL7 is a 7 litre burner.</li> <li>• Fuel can be left inside the burner after use; you do NOT need to burn off completely before putting the lid on.</li> </ul>	<p>Burn Time relates to the number of hours the fuel in the burner will last after lighting it.</p> <ul style="list-style-type: none"> <li>• This is one of the most common questions you will be asked, note, each burner has a different burn time pending size and capacity.</li> <li>• Many factors can impact burn time, including but not limited to; batch of fuel used, age of fuel, air movement, room size, oxygen supply, burner size, temperature, room insulation. Even what type of plant material is used in the manufacturing of the fuel.</li> </ul> <p>*Assumed each burner starts with a full capacity.</p>	<p>The Thermal Output of our burners has been measured in multiple units (Megajoules, BTUs, Kilowatt and Square meters). To facilitate the training, we will be focusing on square meters. This will be the easiest way to explain to your customers the heat output the burner will produce for a specific room size.</p> <ul style="list-style-type: none"> <li>• m<sup>2</sup> calculations are based on an insulated 2.4m floor to ceiling height room. It is important to check the size of the room each fire is going into and the floor to ceiling height to ensure the heating expectations are met. Higher ceilings will impact warmth felt in the room.</li> <li>• The heat output provided means the ethanol burner will add between 5-8 degrees to the rated area, for example, a BK5 burner will add between 5-8 degrees to a 35m<sup>2</sup> room.</li> <li>• Many factors can affect heat output including but not limited to; ceiling height, stairwells, room insulation, flues or chimneys, windows or glass doors, open doors, hallways, wind and areas which are only partially enclosed.</li> <li>• It is important to note the m<sup>2</sup> heat output applies to indoor environments only. When outdoors, convection heat (heating of the air) will dissipate quickly.</li> </ul>	<p>When in operation ethanol burners will consume oxygen from the room, and for this reason it is imperative to check if the area where the burner will be installed if it has enough air space (ventilation) to accommodate it.</p> <p>The table below indicates the minimum room size required to install each burner model due to its ventilation requirements when indoors.</p> <p>**This is something that must be looked at for every burner being put in an enclosed area.</p> <p>Please note that the standard high ceiling is 2.4 metres. If the ceiling height is above this, then you will have more ventilation available in the room and the heat will dissipate in the air.</p>	
XL1200	10L	9 - 14 hours	17 MJ/h - 15,290 BTU/h - 4.5 kW	65m <sup>2</sup>	115m <sup>3</sup>
XL900	9L	8 - 13 hours	16 MJ/h - 15,000 BTU/h - 4.4 kW	60m <sup>2</sup>	110m <sup>3</sup>
XL700	7L	9 - 12 hours	14.5 MJ/h - 13,650 BTU/h - 4 kW	50m <sup>2</sup>	90m <sup>3</sup>
XL500	5L	10 - 13 hours	12 MJ/h - 11,430 BTU/h - 3.35 kW	40m <sup>2</sup>	80m <sup>3</sup>
XS340	2.5L	5 hours	8.93 MJ/h - 8,530 BTU/h - 2.5 kW	20m <sup>2</sup>	45m <sup>3</sup>
BK5	5L	7 - 11 hours	14 MJ/h - 13,000 BTU/h - 3.5 kW	35m <sup>2</sup>	70m <sup>3</sup>
AB8	8L	7 - 11 hours	21.56 MJ/h - 20,433 BTU/h - 5.99 kW	60m <sup>2</sup>	116m <sup>3</sup>
AB3	2.5L	8 - 11 hours	6.14 MJ/h - 5,800 BTU/h - 1.7 kW	20m <sup>2</sup>	40m <sup>3</sup>
VB2	2L	6 hours	7.24 MJ/h - 6,180 BTU/h - 2.5 kW	15m <sup>2</sup>	45m <sup>3</sup>



# Design Considerations

**Before installing an EcoSmart Fire it is paramount to ensure the proposed design is compliant. Some key points to consider below.**

- The burner must be installed into a level surface made of non-combustible material ONLY, such as stainless steel, concrete, brick and stone.
- Installed and operated in a fixed and secure position before filling, lighting and operating. Burners are not meant to be moved because movement creates the risk of accidental fuel spillages.
- NOT INSTALLED DIRECTLY BESIDE OR NEAR WALLPAPER, LAMINATE, VENEER OR ANY SURFACE THAT HAS NOT BEEN FIRE RATED (THE HEAT WILL IMPACT THE MATERIAL).
- Installed after all gas connections or pipelines in the area are disconnected and made safe by an appropriately qualified and licensed professional.
- Clearances to combustible materials are maintained (more information on following page).
- The construction must be able to accommodate the top tray for the burner included with every burner\*, if using a custom tray it must be no more than 200% the size of the burner. \*Excludes VB2 Burner.
- Glass and mirrored surfaces near the burner must be toughened.
- If inserting a Burner into an existing masonry fireplace, adjust the damper within the existing fireplace in order to keep the heat from escaping through the flue.



# Installation

There are two distinct types of burner only installations, “Within a firebox” and “Without a firebox”.

### Within a Firebox

The burner is surrounded by non-combustible materials, similar to a traditional firebox installation. Essentially you are creating a firebox for the burner to sit in. See the table below for the minimum height, depth and width for each burner within this type of installation.

#### A. FIREBOX MEASUREMENTS FOR “WITHIN A FIREBOX” INSTALLATION (Fig.1)

BURNERS	Minimum Firebox Width (X)	Minimum Firebox Depth (Z)	Minimum Firebox Height (Y)
BK5	650mm [25.6in]	365mm [14.4in]	650mm [25.6in]
XL1200	1500mm [59.1in]	350mm [13.8in]	500mm [19.7in]
XL900	1200mm [47.2in]	350mm [13.8in]	500mm [19.7in]
XL700	1000mm [39.4in]	350mm [13.8in]	500mm [19.7in]
XL500	800mm [31.5in]	350mm [13.8in]	500mm [19.7in]
XS340	450mm [17.7in]	300mm [11.8in]	450mm [17.7in]
AB8	650mm [25.6in]	450mm [17.7in]	800mm [31.5in]
AB3	400mm [15.7in]	350mm [13.8in]	500mm [19.7in]

#### AA. BURNER PLACEMENT “WITHIN A FIREBOX” (Fig.2)

BURNERS	Minimum Distance to Front (A)	Minimum Distance to Rear (B)	Minimum Distance to Left (C)	Minimum Distance to Right (D)
BK5	45mm [1.8in]	30mm [1.2in]	125mm [4.9in]	125mm [4.9in]
XL SERIES	50mm [2.0in]	40mm [1.6in]	150mm [5.9in]	150mm [5.9in]
XS340	45mm [1.8in]	65mm [2.6in]	55mm [2.2in]	55mm [2.2in]
AB8	45mm [1.8in]	30mm [1.2in]	145mm [5.7in]	145mm [5.7in]
AB3	45mm [1.8in]	30mm [1.2in]	70mm [2.8in]	70mm [2.8in]

### Without a Firebox

The burner is installed into a non-combustible surface but there are no sides or top to enclose the burner. The table below illustrates the minimum clearances to combustible surfaces.

#### B. BURNER PLACEMENT “WITHOUT A FIREBOX” (Fig.3)

BURNERS	Minimum Indoor Overhead Clearance (E)	Minimum Outdoor Overhead Clearance (F)	Minimum Distance to Combustible Materials (G)
BK5	1500mm [59.1in]	2000mm [78.7in]	600mm [23.6in]
XL SERIES	1500mm [59.1in]	2000mm [78.7in]	600mm [23.6in]
AB SERIES	1500mm [59.1in]	2000mm [78.7in]	600mm [23.6in]

**\*WARNING! Fire hazard. The rear wall should be non-combustible. If it is combustible, you must allow at least 600mm [23.6in] clearance between the wall and the rear of the EcoSmart Fire.**

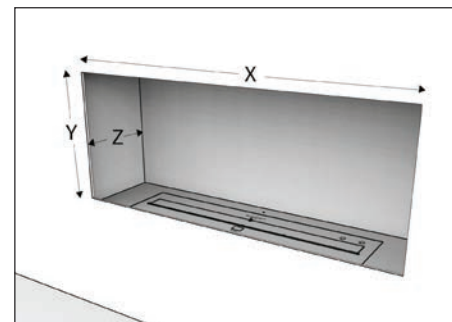

Fig.1

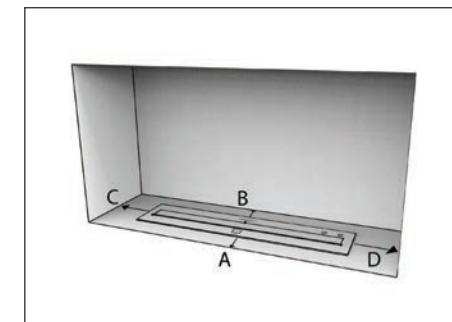

Fig.2

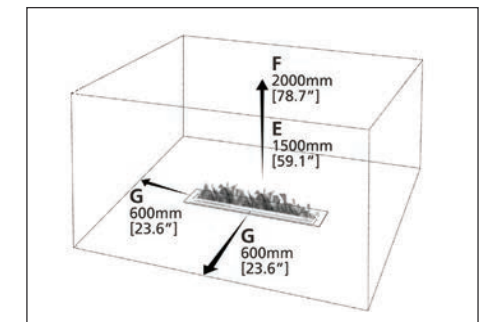

Fig.3



# Common Q&A's

### How do they work?

EcoSmart Ethanol Burners create a flame by burning the vapour that evaporates off of the bioethanol liquid fuel. The fuel is filled through a dedicated filling point where it flows into the fuel reservoir, which is where it is both stored and burned from; this can be seen when you open the lid on the burner.

### What's included when you purchase an EcoSmart ethanol burner?

EcoSmart Ethanol Burners include all the accessories needed to safely fill and operate the appliance:

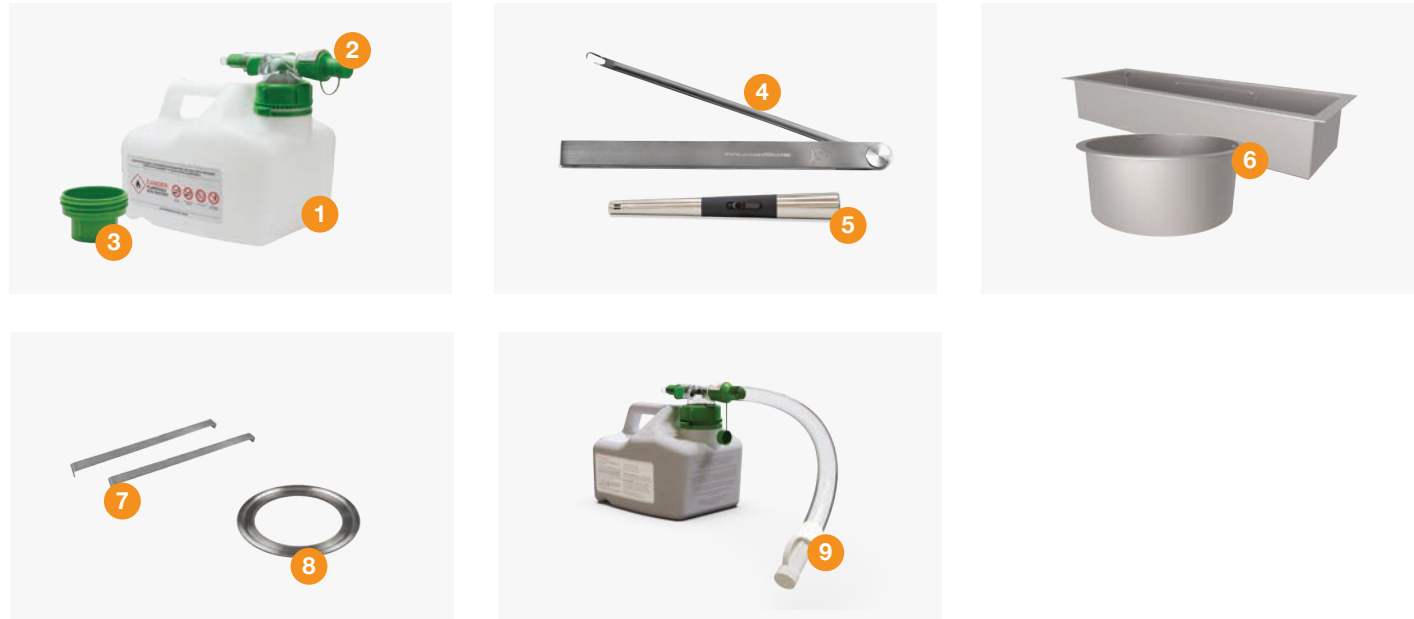

1. Jerry Can 2. No Spill Nozzle 3. Bottle Adaptor 4. Lighter 5. Lighting Rod 6. Top Tray 7. XL Baffles (XL Burners only) 8. AB8 Efficiency Ring (AB8 Burner only) 9. Extension Spout (AB3 Burner only)

### How long will the fuel burn?

This is dependent on the burner and how it's used, as mentioned, you are burning the vapour that evaporates from the liquid so the size of the mouth of the burner will affect this greatly. A larger more open mouth means more surface area for the ethanol fuel to evaporate from.

This is also why most of our burners\* will have some type of baffle or sliding baffle to increase burner efficiency; a smaller surface area for fuel to evaporate from means slower evaporation, lower heat output and better fuel efficiency. \*Excluding AB3 and VB2 burners.

### Do they need power or a flue/chimney?

Ethanol fires do not require a chimney, vent, gas line, or electricity and can be installed virtually anywhere - indoors or outdoors. This means they do not require a specialised installer and can be moved from one area to another with relative ease.

### How do I fill them?

With EcoSmart Fire's proprietary tools and procedures, filling your ethanol fireplace with e-NRG bioethanol fuel is fast and easy.

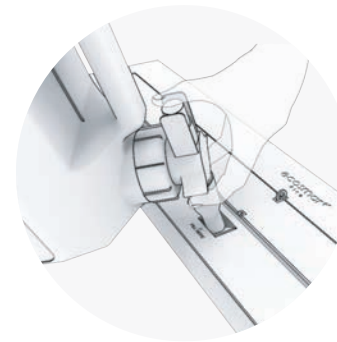

#### Step 1

Remove the bottle nozzle cap and carefully insert into the filling point.

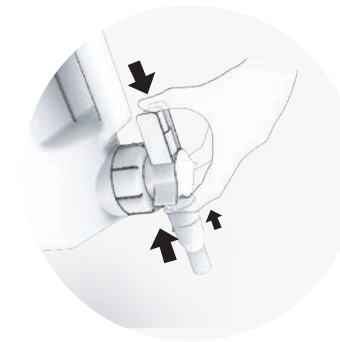

#### Step 2

Push and hold the green button. The nozzle will automatically stop filling once the reservoir is full.



#### Step 3

Replace the nozzle cap. To turn the burner off simply close the lid, this will starve the flame of oxygen and extinguish it.

#### IMPORTANT

**Shut the appliance off and allow it to cool 60 minutes before refueling. Flame may be difficult to see - do not assume the appliance is off.**

**The shut-off mechanism on the Burners will become very hot during operation and will stay hot for up to 60 minutes after use.**

**Crushed glass, pebbles or other refractory decorative media accessories should not be placed directly over the Burner mouth, interfering with the flame or lid operation.**

**It is important to keep the lid on and closed when not in operation to avoid unnecessary evaporation and smell. This will also help prevent the ethanol fuel from "taking on" water which ultimately affects the flame colour, size and heat output.**

# Common Q&A's

## Do they heat?

EcoSmart Fire's indoor ethanol fireplaces are ventless, meaning all the heat stays in the room rather than escaping up a flue or chimney like it would with a traditional wood-burning fireplace. Increased heat retention also means increased fuel efficiency. EcoSmart Fire's collection of ethanol fireplaces offer a heat output ranging from 5,000 BTU (15m<sup>2</sup>) - 20,000 BTU's (65m<sup>2</sup>).



## Why use an ethanol fireplace?

An ethanol fireplace is an eco-friendly and cost-effective alternative to gas fireplaces and wood burning fireplaces. Enjoy the warmth and aesthetic benefits of a traditional fireplace without the smoke, soot or ash in your home. Unlike gas fireplaces or traditional wood burning fireplaces, EcoSmart Fire's ethanol fireplace inserts require no venting, no gas line, no electricity - eliminating the need and cost of three sub contractors.

				
Produces a vibrant orange flame	Efficiency over 90%	Clean-burning. No smoke, no ash	No gas, no electricity, no flue	Quick and easy installation

## Are they easy to operate?

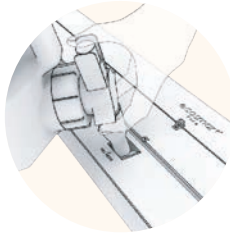
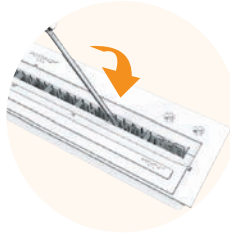
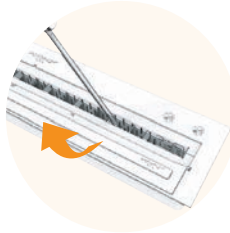
Operating an EcoSmart Fire is very simple, it can be done in a few steps.

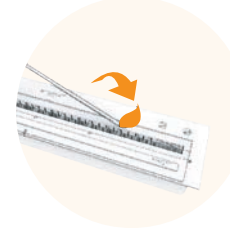
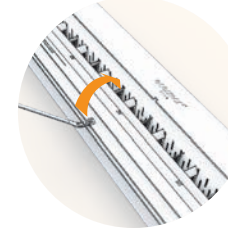
					
Safely fill burner with e-NRG fuel	Dip the lighting rod tip into the burner	Lift the lighting rod out of the burner	Use lighter to ignite lighting rod	Dip ignited lighting rod back into the burner	Simply close burner lid to turn burner off

## Are they easy to install?

EcoSmart Fires are designed to be easily installed and operated. Without the need for a flue or pipe connection, EcoSmart Fires are extremely flexible and can be incorporated at any stage of your interior decorating, renovating or building works. For detailed specifications please contact your local distributor.

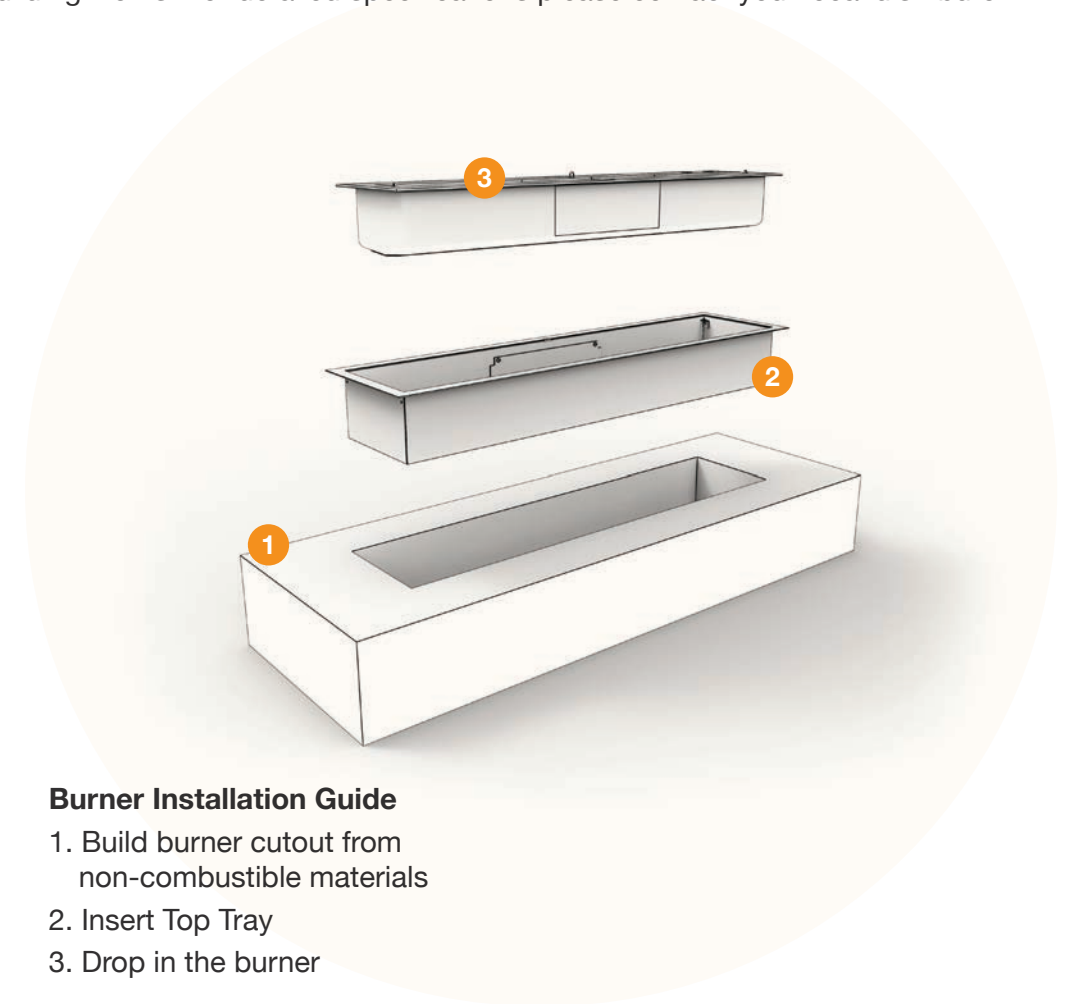

### Burner Installation Guide

1. Build burner cutout from non-combustible materials
2. Insert Top Tray
3. Drop in the burner