

VelociRAX

Rack'em Fast

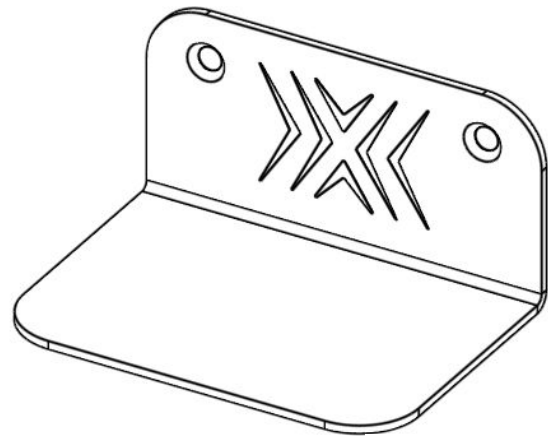

Latest instructions
and videos:
[www.velocirax.com/
pages/assembly](http://www.velocirax.com/pages/assembly)

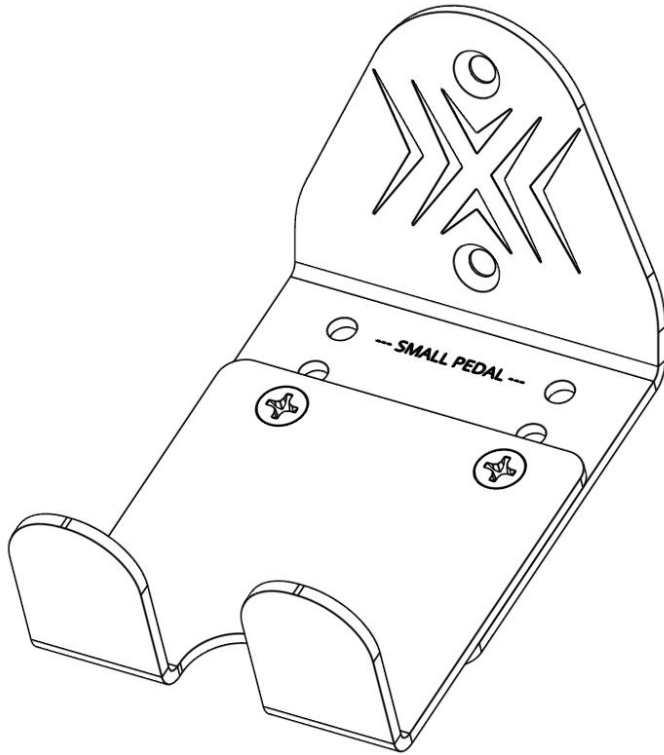
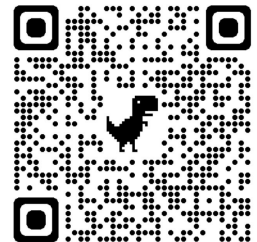

PedalRAX Assembly and Instruction Manual

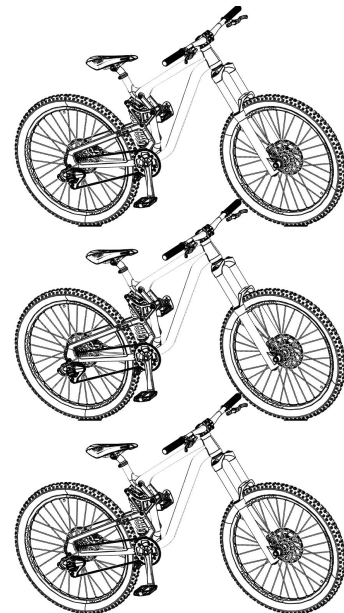
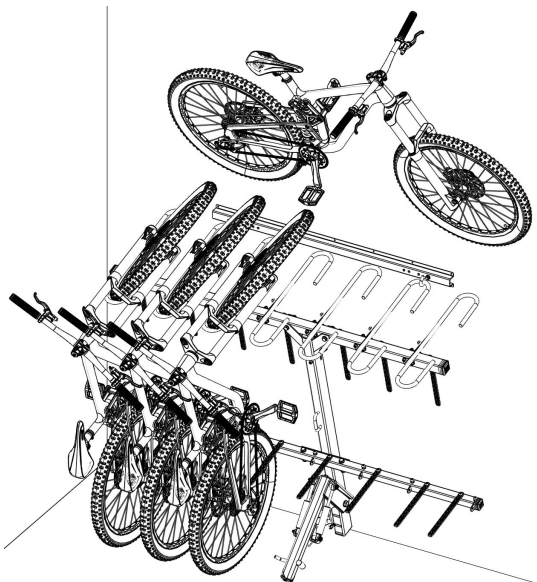

Rack'em on your vehicle AND Rack'em in the garage





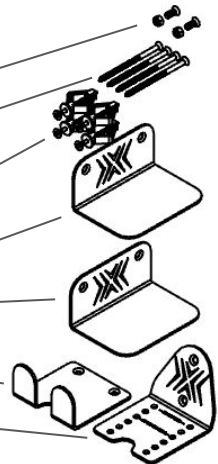

PACKAGE CONTENTS

TOOLS REQUIRED FOR ASSEMBLY

Wall Pedal Mount RAX

- (2) Fasteners
- (2) Nylock Nuts
- (6) Screws
- (6) Drywall Anchors
- (2) Tire Brackets
- (1) Pedal Bracket
- (1) Wall Bracket



- 1 X 8 mm  Or 
- 1 X #2  
- 1 X #2  

ASSEMBLY INSTRUCTIONS

Latest instructions and videos: www.velocirax.com/pages/assembly



Step 1. Size the Wall / Pedal Bracket for your bikes

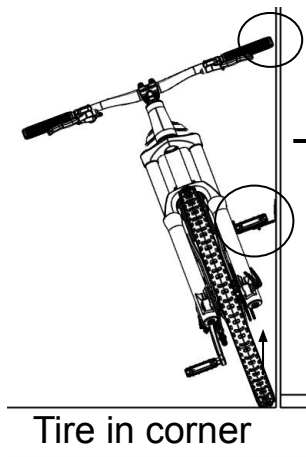

- Lengthen the wall/pedal bracket until both the pedal and handle bar clear the wall
- Wait to install the fasteners

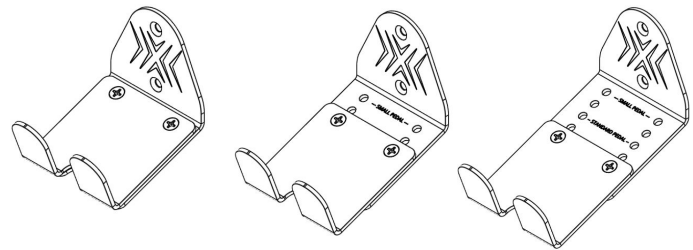
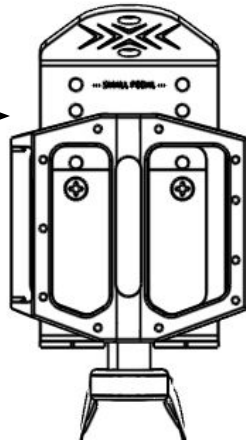

Step 2. Locate and Secure the Wall Bracket into a 2X4

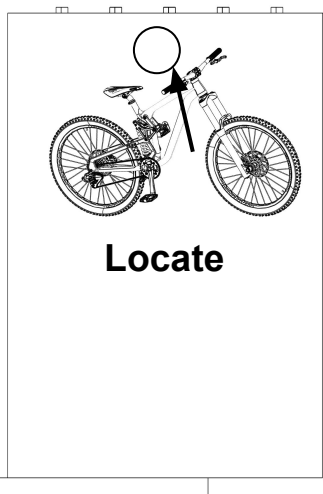

- Determine bracket location by holding up the bike & bracket
- Secure wall bracket to 2X4 with provided screws
- Assemble Pedal Bracket as shown at predetermined size

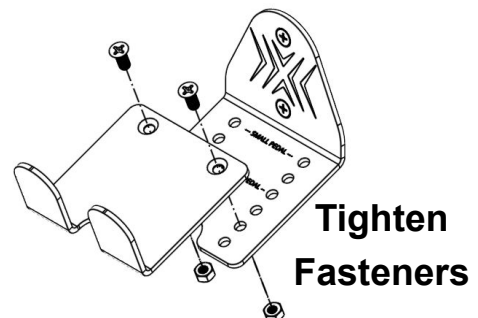
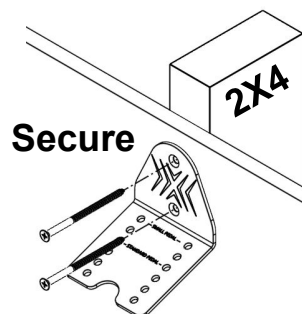

INSTALL TIPS

Step 3. Secure Tire Brackets

- Place bike & mark tire bracket locations
- Secure Tire Bracket to wall with drywall anchors

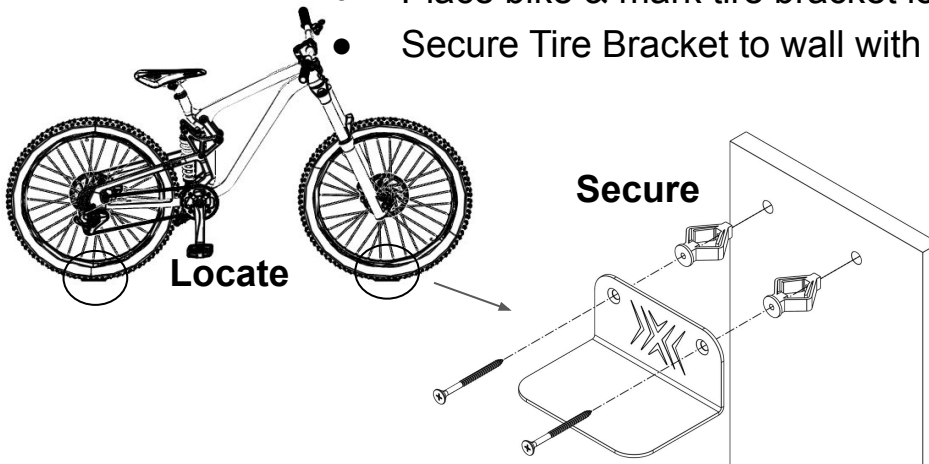

- Drill a 3/8" hole and insert drywall anchor
- Insert screw through bracket and fasten screw (Don't overtighten)

Step 4. Store your Bike

- The Tire Brackets may need to be adjusted for different bikes
- Options:
 - Store a Bike above your VelociRAX vehicle rack (8 bikes in X 7ft)
 - Store 3 Bikes up one wall (For tighter stacking extend the pedal bracket fully to provide additional tire clearance)

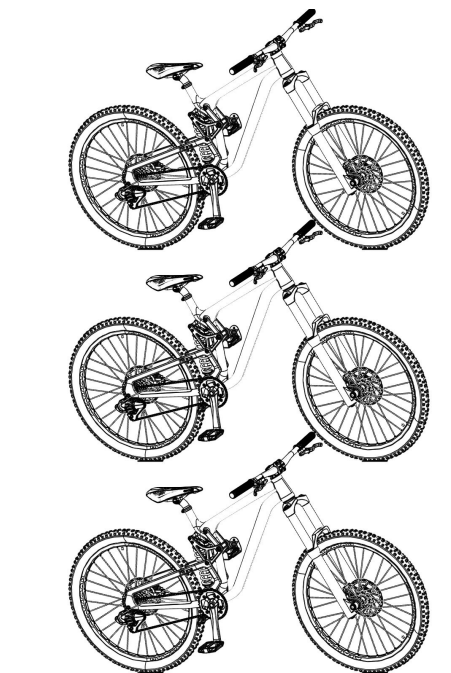
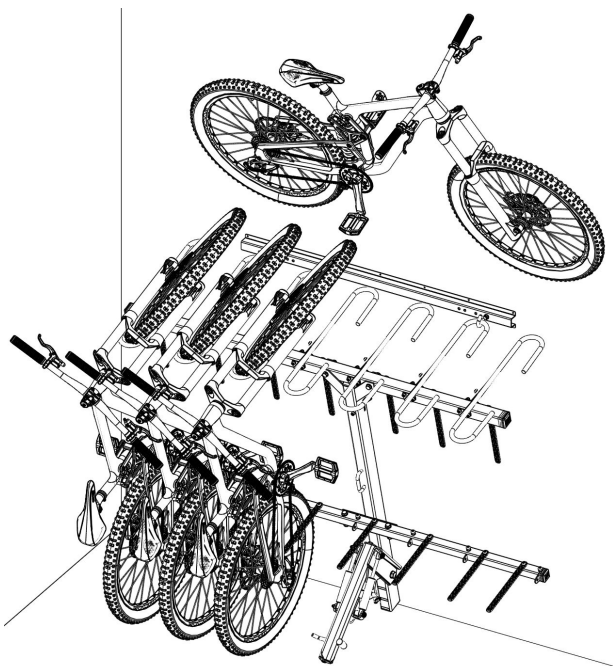

VelociRAX



Congratulations on your VelociRAX purchase!

For support contact us at: Support@velocirax.com

For the latest version of these instructions, along with helpful instructional videos, please go to:

www.velocirax.com/pages/assembly

WARRANTY INFORMATION

2 Year Limited Warranty for defects in materials and/or workmanship for the original retail purchaser. This warranty does not cover normal wear and tear, scratches, accidents, misuse, or overloading.

CONTACT INFORMATION

VELOCIRAX

Email: support@velocirax.com

Web address: www.VelociRAX.com

Phone: 435.344.4446