

# Tent Canopy (3x6m)

File:  
Please provide the source file, Like: Illustrator, Photoshop or Coreldraw.  
Files should be set up in CMYK color mode.  
All files please supply .jpg files for proof.  
If you have any colour requirement, please give us the PANTONE NO. or printing sample.

File Setup:  
Vectorized file: > 1:1 size or size in right proportionate.  
Make sure all fonts convert to curves.  
Any images placed in vectorized should be in CMYK format and with at least 100DPI resolution, and provide separate.

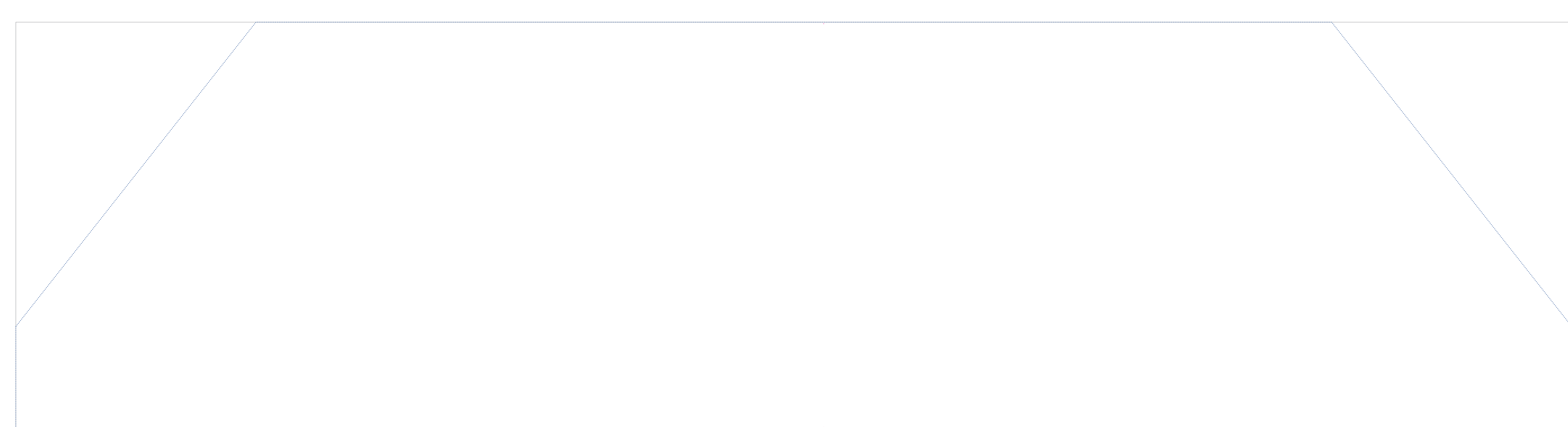
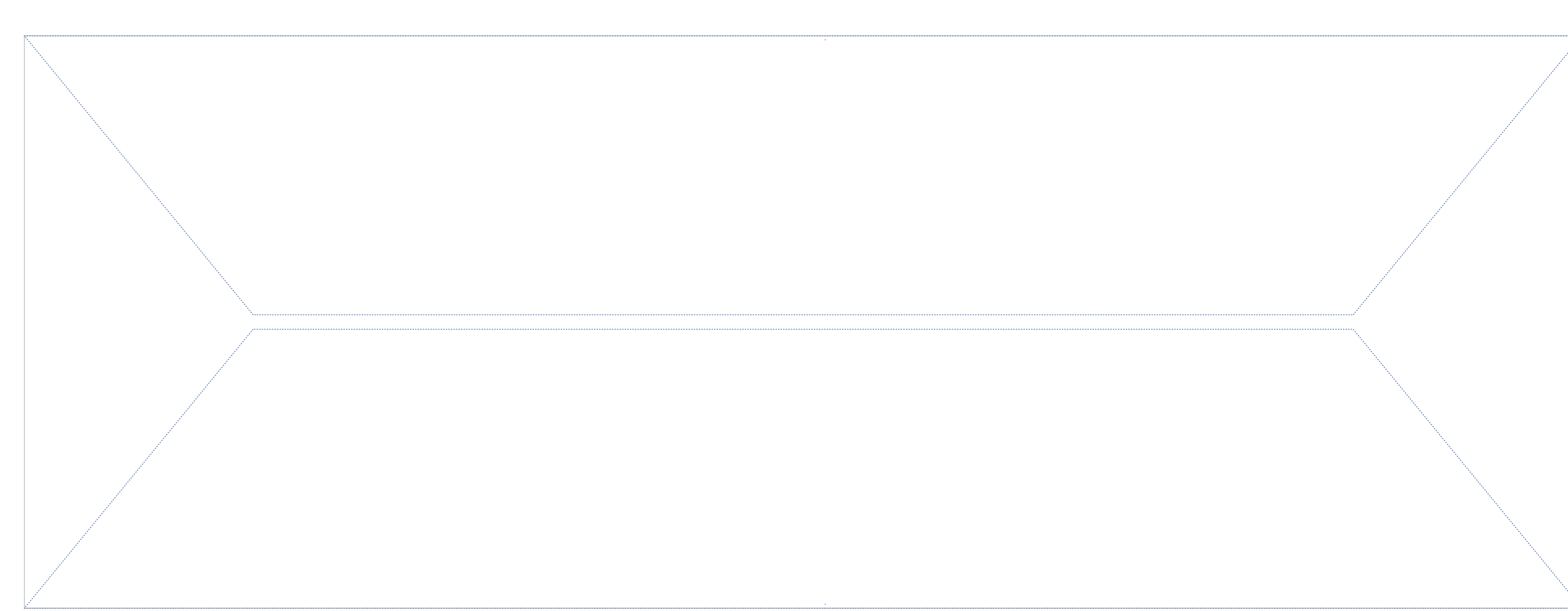
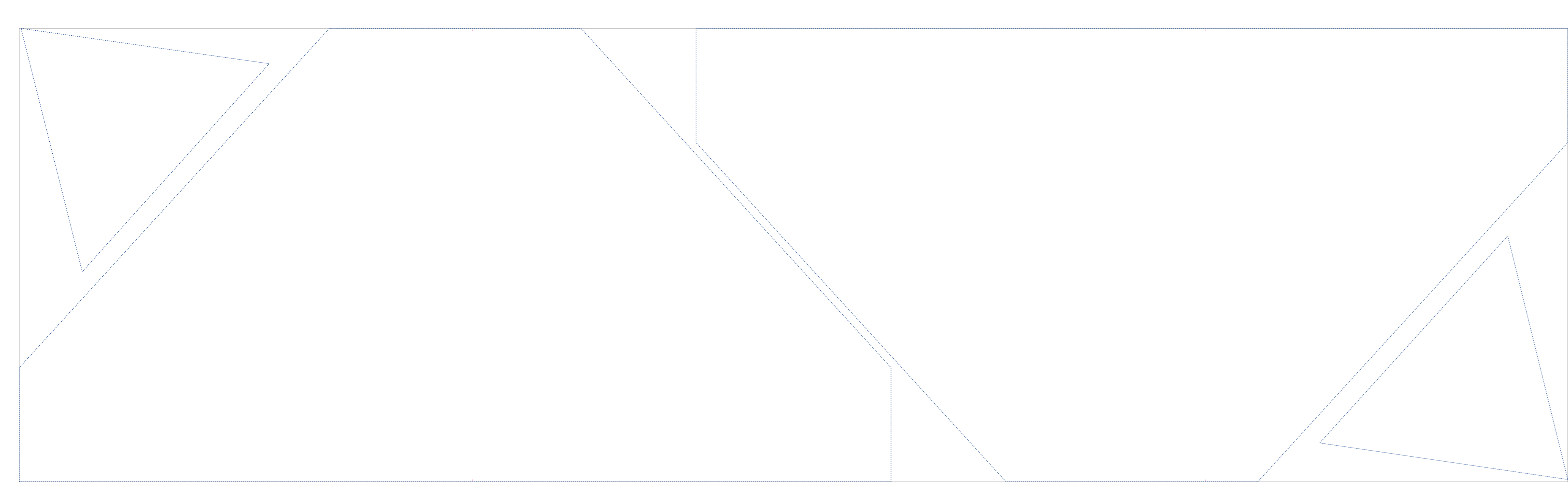
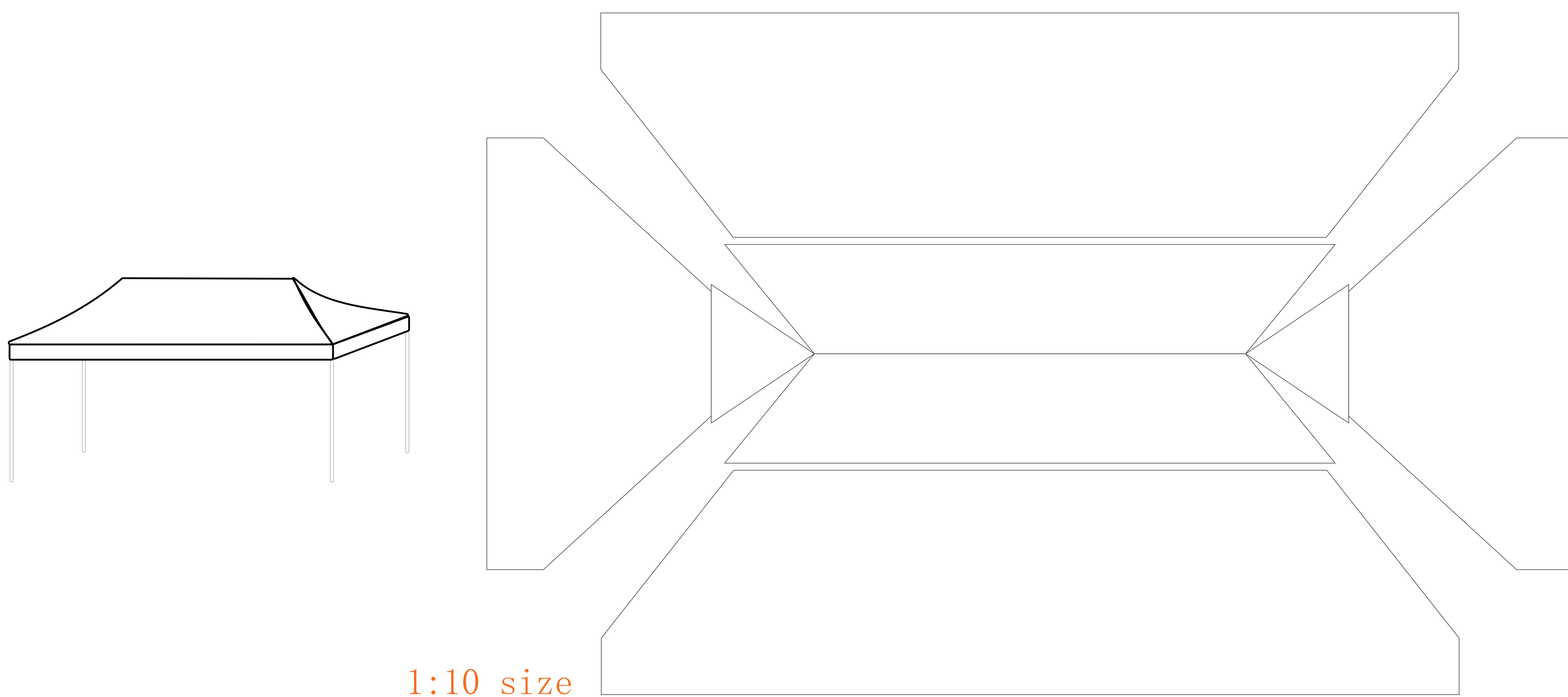
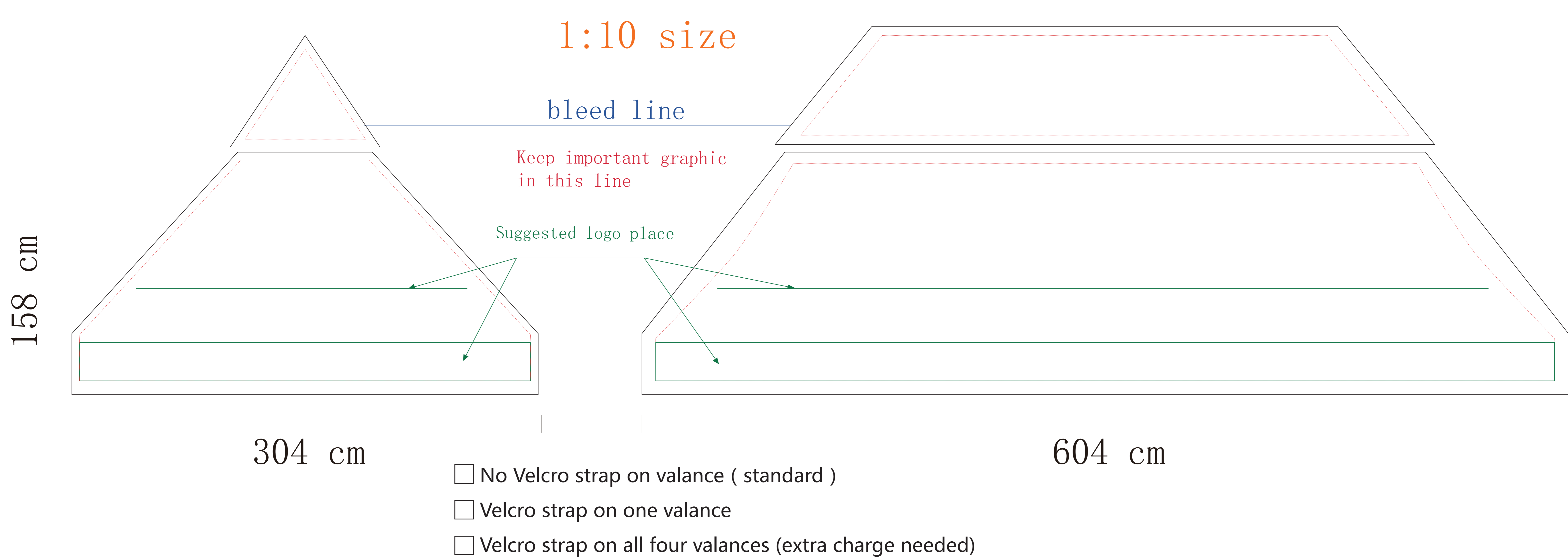

## TENT WALL 6M

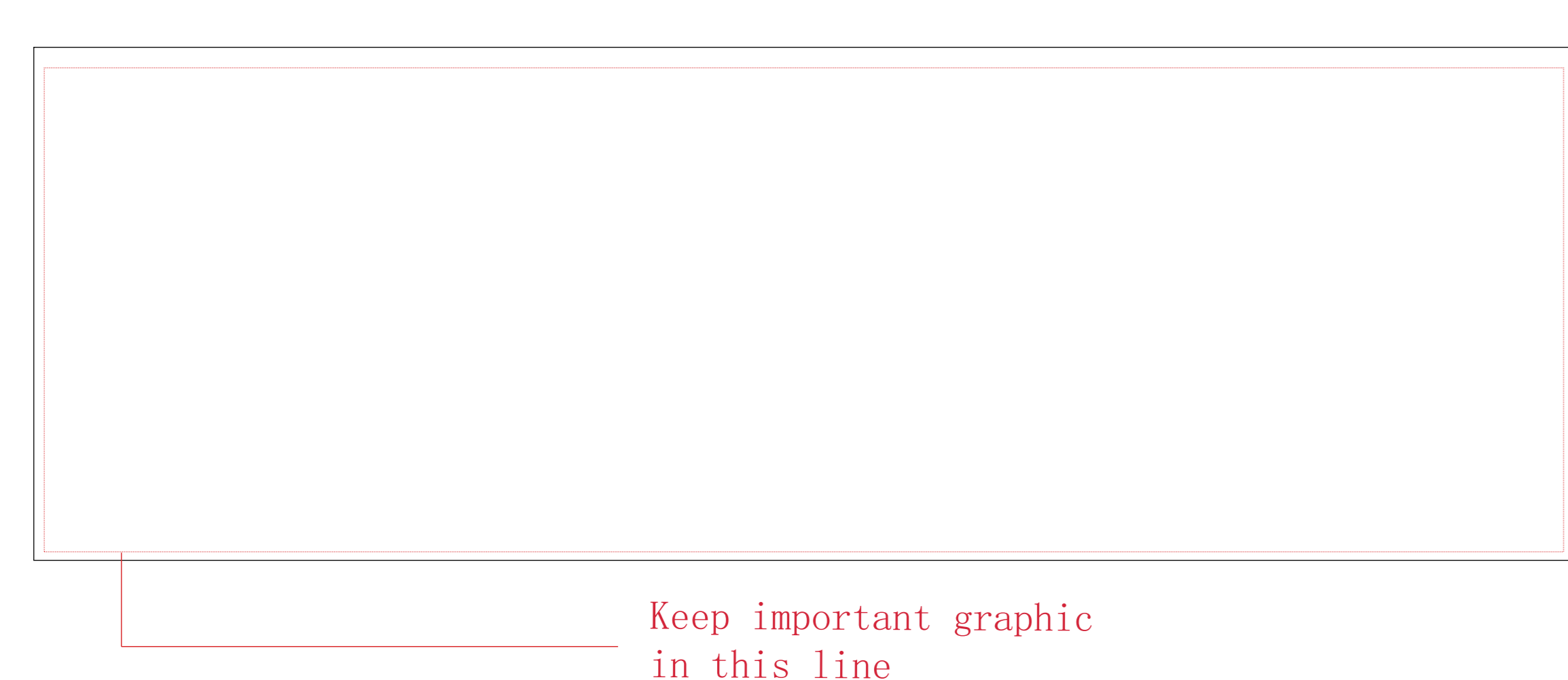

Template size :600x200cm 1:20

## TENT WALL 3M

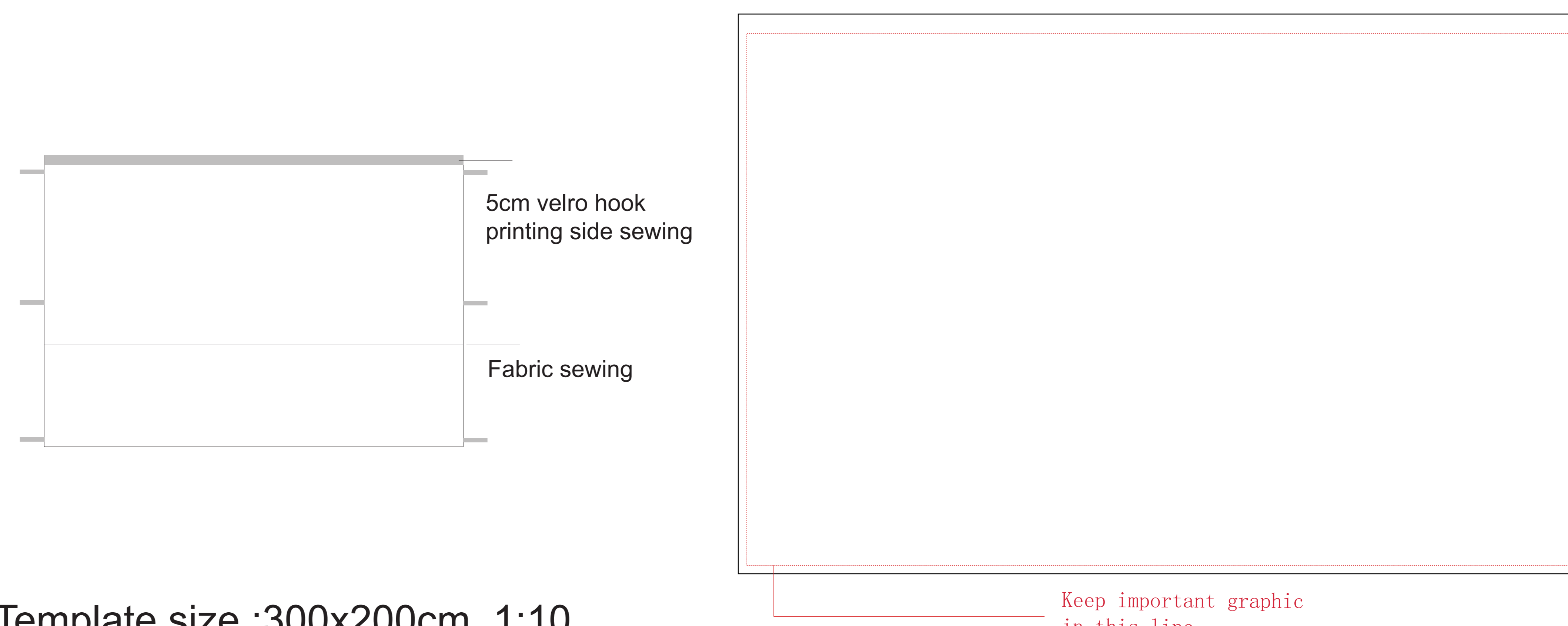

Template size :300x200cm 1:10

## Half skirt with sleeve for 3M

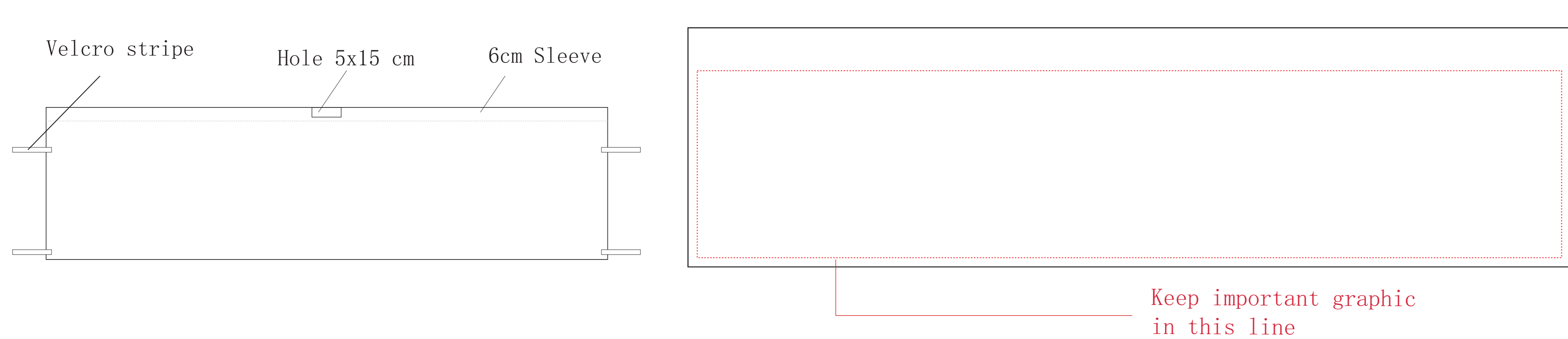

Template size :288x78cm 1:10

## Half skirt for 3m



Template size :300x75cm 1:10

## Half skirt for 6M

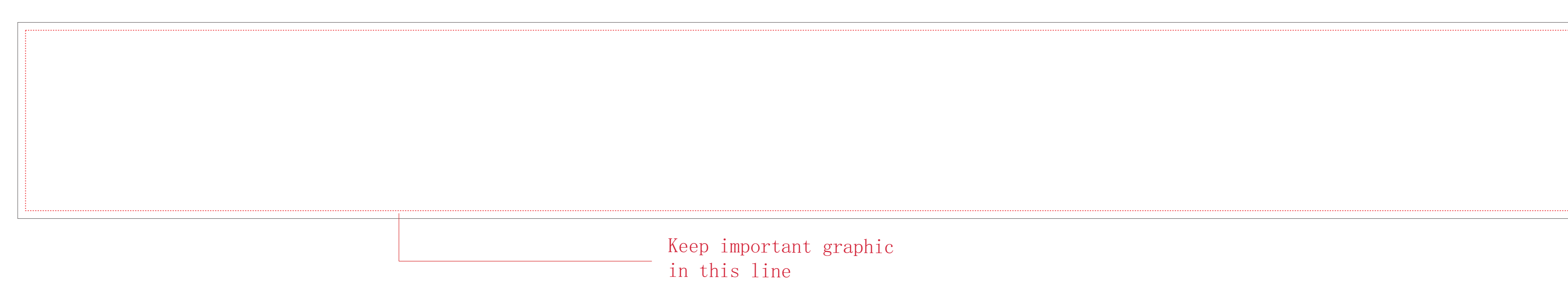
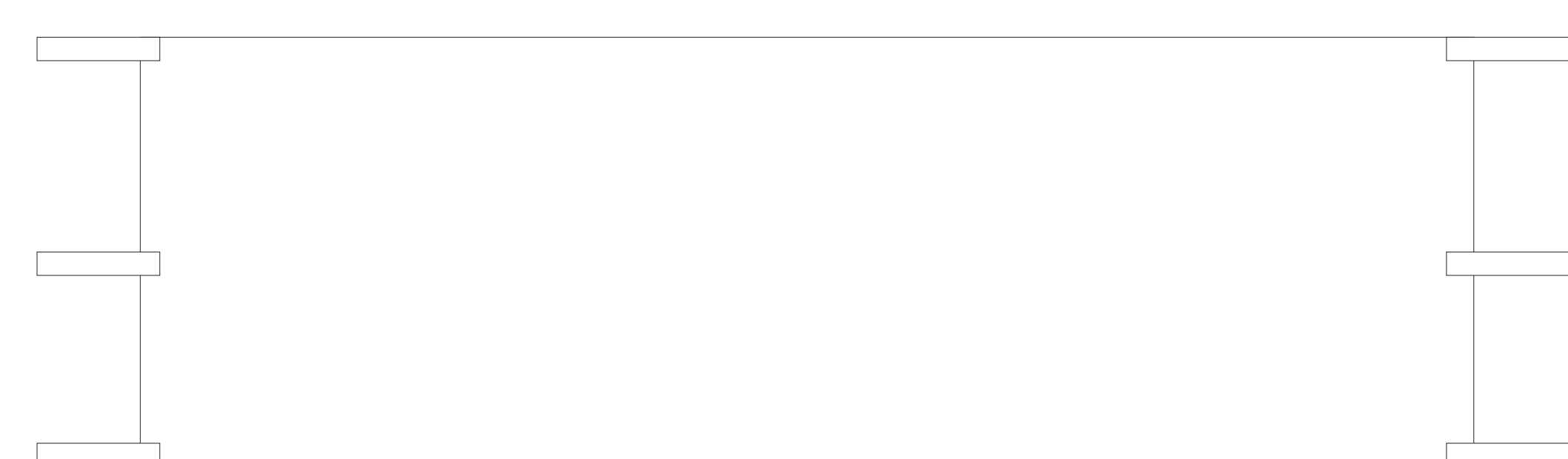

Template size :600x75cm 1:10