

Roman Blind Systems

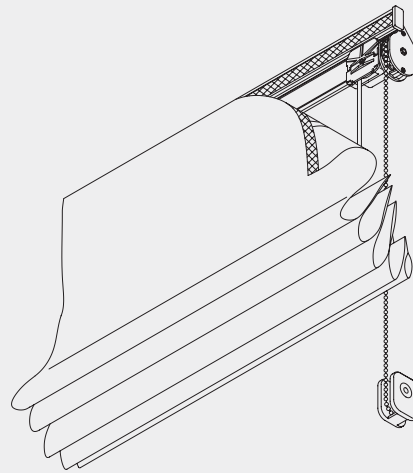

Chain Operated Roman Blind System

Silent Gliss® 2020



Product Information

- Simple-to-operate and robust bead chain operation
- Blind stops at any required height without slippage or the need to lock-off
- Smooth finger-touch operation
- Made-to-measure or can be bought in modest bulk quantities
- Tape spool cassette pre-loaded with drawing tape for up to 3m drop
- Easy wall or ceiling-fix and removal
- Easy removal of blind for washing
- Excellent cost/performance ratio
- Compliant with Child Safety Legislation (EN13120)



2020

Profile, Bending and Specification Information

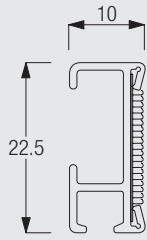

2116



Cannot be bent

Specification Guide - download from www.silentgliss.co.uk (password required).

Silent Gliss 2020 chain operated headrail system for Austrian/Roman blinds. Ready assembled with Silent Glissfabric colour/for customer to attach own fabric. Headrail 2116 with bonded Velcro wall-fixed with brackets 3630/top-fixed with brackets 3603. Tape spool cassettes 2032 pre-loaded with lift tape to max. 3m drop. System supplied fitted with rail endcovers 2131, gear drive 2049, 2059 safety clip x 2, chain connector 2865, hexagonal bar 2111, bead chain 4845 to required drop and tape spool cassettes 2032 as standard. Chain operation left hand/right hand. Qty tape spool cassettes at cm centres.

System Dimensions



2.5m



3m



7.5



3kg

Max 0.7kg per spool

The system dimensions depend on the total fabric weight including the bottom bar, lead weight tapes and cross rods (for hard fold Roman blinds).

Fitting and Sewing Information



2020

WARNING

Young children can be strangled by loops in pullcords, chains, tapes and inner cords that operate the product. To avoid strangulation and entanglement, keep cords out of the reach of young children. Cords may become wrapped around a child's neck. Move beds, cots and furniture away from window covering cords. Do not tie cords together. Make sure cords do not twist to create a loop.

Bracket positioning

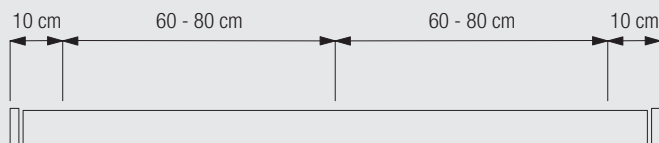

When fitting, allowances must be made for spool positioning and gear chain.

Bracket fixing



With profile 2116: Applicable with 3603/3630/3655/3660

Installation: roll track onto bracket in direction indicated
 Removal: 1. Press to release 2. Rotate forward for removal

Fixing of tapes

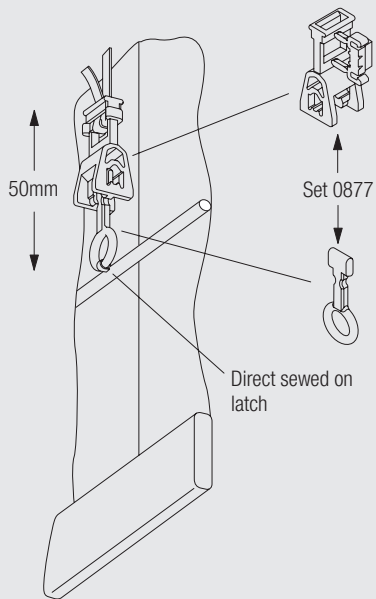

Using Breakaway Bottom Bar Set 0877

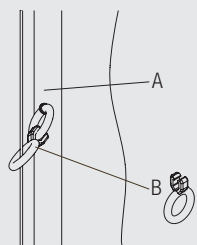

Soft fold:

- A: Breakaway Ring Tape Set 0879
- B: Set includes Child Safety Eyelet

Note: The Breakaway Ring Set is available without tape (part number 0878).

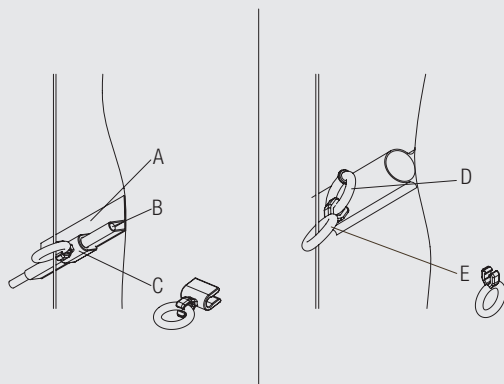

Hard fold:

- A: Tape 2136
- B: Steel rod 2135
- C: Child Safety Eyelet (hard fold) 3069

D + E: Breakaway Ring Set 0878



2020

Fitting Options

Ceiling fix with bracket 3603

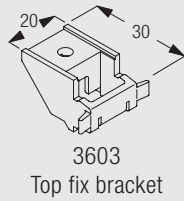
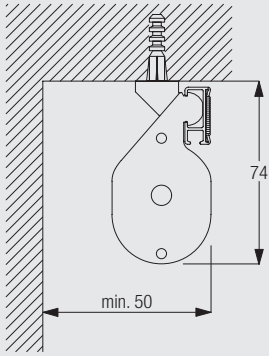

Wall fix with brackets 3630 3655 and 3660

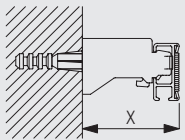

	X (mm)
3630	39
3655	55
3660	69

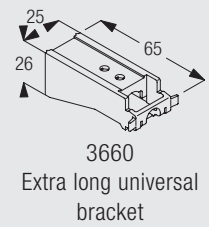
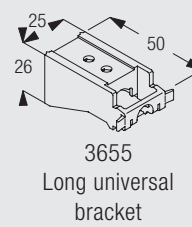
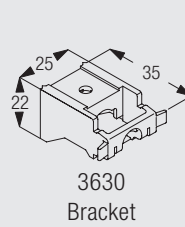

Wall fix with brackets 3134-39 and bracket 3603

2020

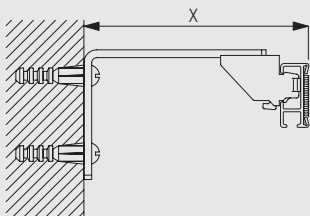

	x (mm)	w (mm)	y (mm)	z (mm)
3134	77	-	50	-
3135	97	-	50	50
3136	117	-	50	50
3137	137	-	80	50
3138	167	60	80	60
3139	217	85	80	85

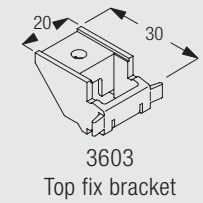
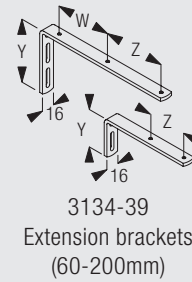

Brackets feature thread for screw 6748 for fixing the bracket 3603

Wall fix with adjustable brackets 3275-77 and bracket 3603

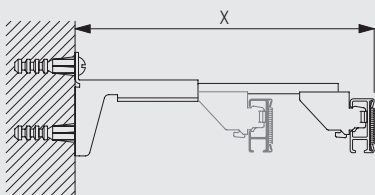



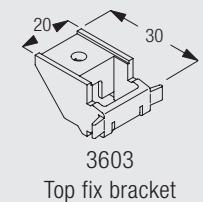
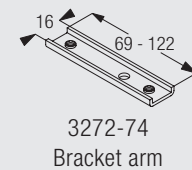
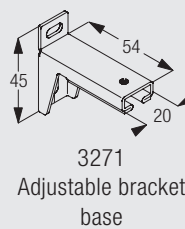





	X (mm)
3275	68-114
3276	85-138
3277	138-168

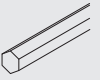



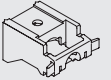





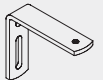
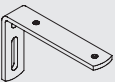
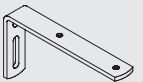
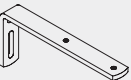
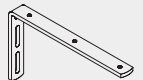
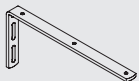

Brackets feature thread for screw 6748 for fixing the bracket 3603.
Brackets 3275-77 are a combination of 3271 and 3272-74.

Standard Accessories

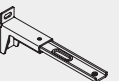

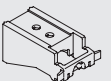
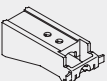
2032	Tape spool cassette		2049	Gear drive	
2059	Safety clip		2111	Hexagonal bar	
2116	Velcro profile		2131	Short endcover	
3056	Tape centralizer		3630	Bracket	
4845	Metal bead chain		10400	Safety Cord Retainer	

Optional Accessories

2006	Weight bar		2048	Plastic bead chain	
2093	Ring		2865	Bead chain connector	
3133	Bracket cover (60mm)		3134	Extension bracket (60mm)	
3135	Extension bracket (80mm)		3136	Extension bracket (100mm)	
3137	Extension bracket (120mm)		3138	Extension bracket (150mm)	
3139	Extension bracket (200mm)		3275	Adjustable extension bracket set (69mm)	
3276	Adjustable extension bracket set (92mm)		3277	Adjustable extension bracket set (122mm)	
3603	Top fix bracket		3655	Long universal bracket	
3660	Extra long universal bracket		6748	Cheese head machine screw (M4)	
3133L	Extended bracket cover for 3137/8/9				

2020

Sewing Accessories

0877	Breakaway bottom bar set		0878	Breakaway ring set (soft fold)	
------	--------------------------	---	------	--------------------------------	---

0879 Breakaway ring tape (soft fold)



2135 Steel rod



2136 Rod Tape



3069 Breakaway rod cover (hard fold)



2020

Chain Operated Roman Blind System

Silent Gliss® 2120

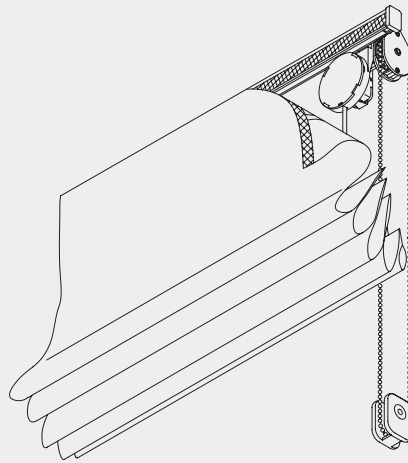

Product Information

- Delivered ready-assembled to exact size for attaching to blind and fitting
- For blinds up to 4m in width and a drop of up to 6m
- The endless bead chain operation makes 2120 ideal for blinds which are large or inaccessible or where trailing cords are not suitable
- Left or right hand pull
- Blinds weighing up to 8kg can be effortlessly operated
- No locking-off required - blind stops without slipping at any required position
- Simple ceiling or wall fixing
- With universal joint 2072A, blinds for bay windows can be achieved in one system
- Single or double bends are possible up to 4m with weight limitations
- Compliant with Child Safety Legislation (EN13120)



2120

Profile, Bending and Specification Information

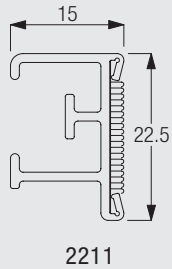

Specification Guide - download from www.silentgliss.co.uk (password required).

Silent Gliss 2120 chain operated headrail system for Roman/Austrian blinds. Ready assembled with Silent Gliss fabric colour / for customer to attach own fabric. Headrail 2211 fixed with standard accessories according to Silent Gliss main catalogue. Bead chain operation, left hand pull/right hand pull via 2049 gear drive. Take-up reel 2081 atcm centres supplied with drawing tape 2163.

System Dimensions



4m



6m



24



8kg

Max 1.25kg per spool

The system dimensions depend on the total fabric weight including the bottom bar, lead weight tapes and cross rods (for hard fold roman blinds).

Fitting and Sewing Information

WARNING



2120

Young children can be strangled by loops in pullcords, chains, tapes and inner cords that operate the product. To avoid strangulation and entanglement, keep cords out of the reach of young children. Cords may become wrapped around a child's neck. Move beds, cots and furniture away from window covering cords. Do not tie cords together. Make sure cords do not twist to create a loop.

Bracket positioning and fixing

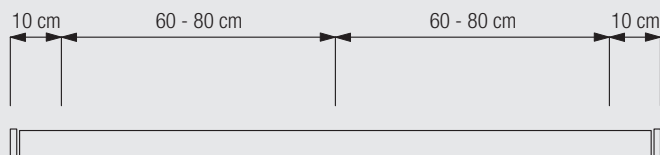

The effective measurements are determined by the actual height, width, structure and make-up style of the curtain.



Applicable with brackets 3603/3630/3655/3660

Installation: Roll track onto bracket in direction indicated.
Removal: 1. Press to release 2. Rotate forward for removal.

Fixing of cords / tapes

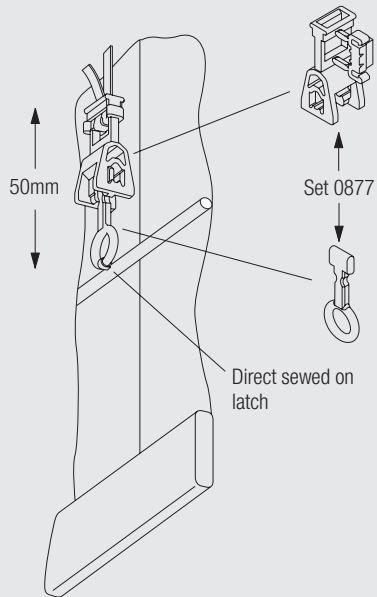

Using Breakaway Bottom Bar Set 0877

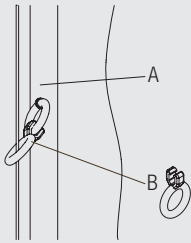

Soft fold:

A: Breakaway Ring Tape Set 0879
B: Set includes Child Safety Eyelet

Note: The Breakaway Ring Set is available without tape (part number 0878).

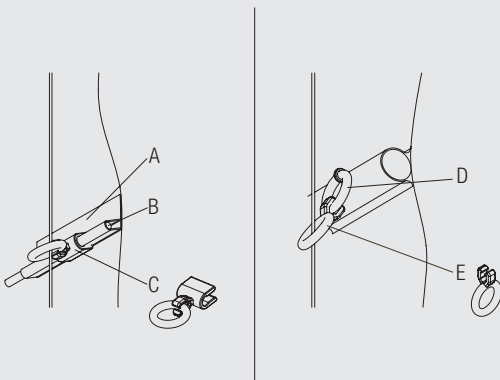

Hard fold:

A: Tape 2136
B: Steel rod 2135
C: Child Safety Eyelet (hard fold) 3069

D+E: Breakaway Ring Set 0878



2120

Fitting Options

Ceiling fix with bracket 3603

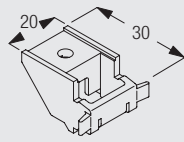
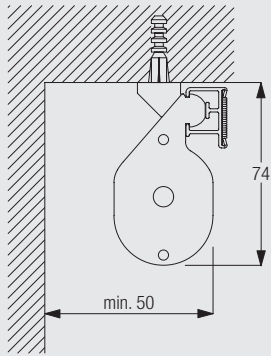

3603
Top fix bracket

Wall fix with brackets 3630, 3655 and 3660

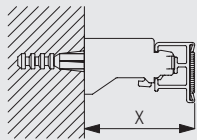

	x
3630	43mm
3655	58mm
3660	73mm

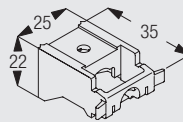

3630
Bracket

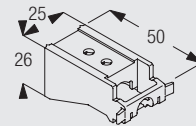

3655
Long universal
bracket

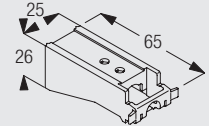

3660
Extra long universal
bracket

Wall fix with brackets 3134-39 and bracket 3603

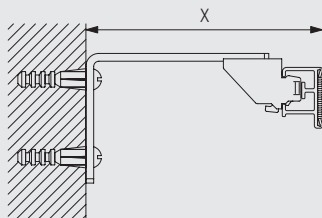

	x (mm)	w (mm)	y (mm)	z (mm)
3134	71mm	-	50	-
3135	91mm	-	50	50
3136	111mm	-	50	50
3137	131mm	-	80	50
3138	161mm	60	80	60
3139	211mm	85	80	85

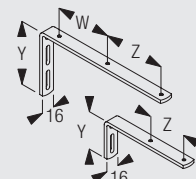

3134-39
Extension brackets
(60-200mm)

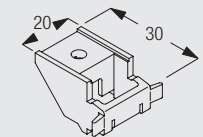

3603
Top fix bracket

Brackets feature thread for screw 6748 for fixing the bracket 3603

Wall fix with adjustable brackets 3275-77

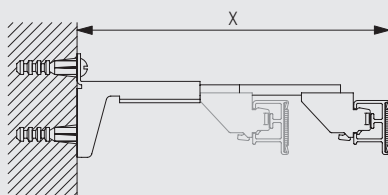

	X (mm)
3275	73-119
3276	90-143
3277	143-173

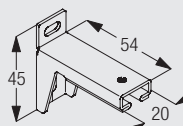

3271
Adjustable bracket
base

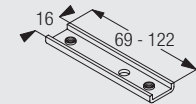



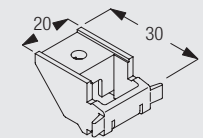







3272-74
Bracket arm

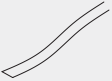

3603
Top fix bracket



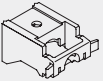







Brackets feature thread for screw 6748 for fixing the bracket 3603.
Brackets 3275-77 are a combination of 3271 and 3272-74.

Standard Accessories

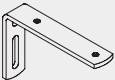
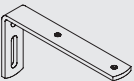
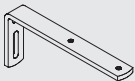
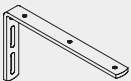
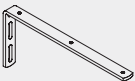
2049	Gear drive		2059	Safety clip	
2081	Take-up reel		2111	Hexagonal bar	
2163	Flat drawing tape		2179	Endcover (24.8mm)	
2211	Velcro profile		2865	Bead chain connector	
3630	Bracket		4845	Metal bead chain	
10400	Safety Cord Retainer				

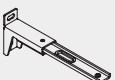
For general fabric make-up and components see system 2100

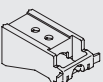
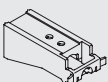
Optional Accessories

2006	Weight bar		2048	Plastic bead chain	
2579	Auxiliary brake		3133	Bracket cover (60mm)	
3134	Extension bracket (60mm)		3135	Extension bracket (80mm)	
3136	Extension bracket (100mm)		3137	Extension bracket (120mm)	
3138	Extension bracket (150mm)		3139	Extension bracket (200mm)	
3275	Adjustable extension bracket set (69mm)		3276	Adjustable extension bracket set (92mm)	
3277	Adjustable extension bracket set (122mm)		3603	Top fix bracket	
3655	Long universal bracket		3660	Extra long universal bracket	
6748	Cheese head machine screw (M4)		3133L	Extended bracket cover for 3137/8/9	



2120

Sewing Accessories

0877 Breakaway bottom bar set



0878 Breakaway ring set (soft fold)



0879 Breakaway ring tape (soft fold)



2135 Steel rod



2136 Rod Tape



3069 Breakaway rod cover (hard fold)



2120

Chain Operated Roman Blind System

Silent Gliss® 2320

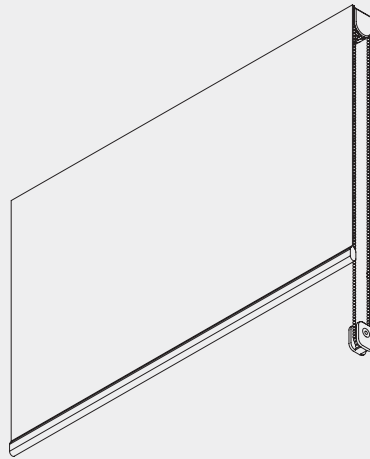

Product Information

- Chain operated Roman blind system for residential and contract applications
- Suitable for small to medium size applications
- New wind-up technique
- Very elegant appearance as all workings are hidden in a smart cassette
- Easy cleaning / maintenance through new cord release mechanism
- Extremely smooth and easy operation
- Blind stops at any required height without slippage
- Left or right hand operation
- Easy ceiling or wall fix to all surfaces
- Side guide option available
- Plastic or steel operating chain options available
- Compliant with Child Safety Legislation (EN13120)



2320

Profile, Bending and Specification Information

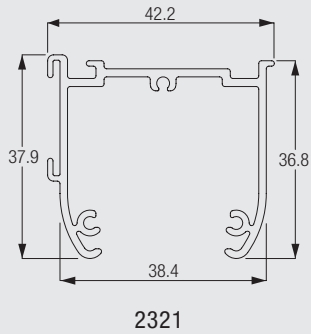

Cannot be bent.

Specification Guide - download from www.silentgliss.co.uk (password required).

Silent Gliss Roman/Austrian headrail system 2321 with bonded velcro 2221 insert in white. Fabric to be attached to profile using pile section velcro. Profiles to have endcovers 2337/2339. Blind to be lifted using cord 2216 attached to profile 8214 using cord release mechanism 2322/2323. Bead chain operation, left/right hand pull via gear drive 2335. Top/face fix using 2343 universal bracket at 80cm centres.

How to Measure

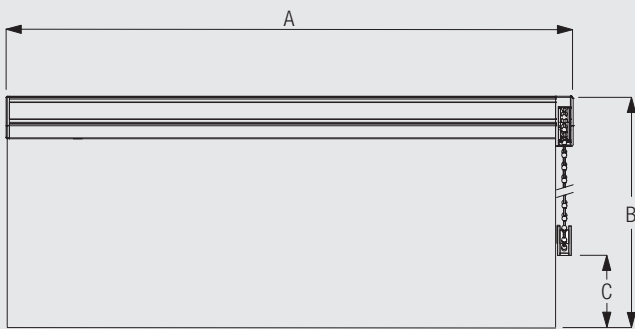

A: System length
B: System height



2320

System Dimensions



3.0m



3.0m



2.5kg

The system dimensions depend on the total fabric weight including the bottom weight bar.

For applications with a total weight of more than 2.5kg, refer to system 2330.

System Option Side guide

Side guides for stabilizing and sloping applications (up to 15°)

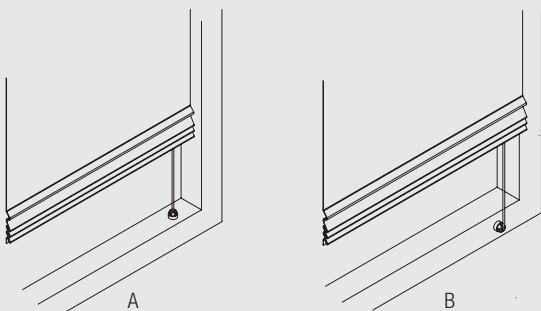

A: Fitting of side guides inside window frame
B: Fitting of side guides onto front of window frame

Fitting of side guides inside window frame or onto front of window frame. The system 2320 can be equipped with side-guide wires (0776) and can therefore also be used for sloping applications up to 15° inclination.

Child Safety Device

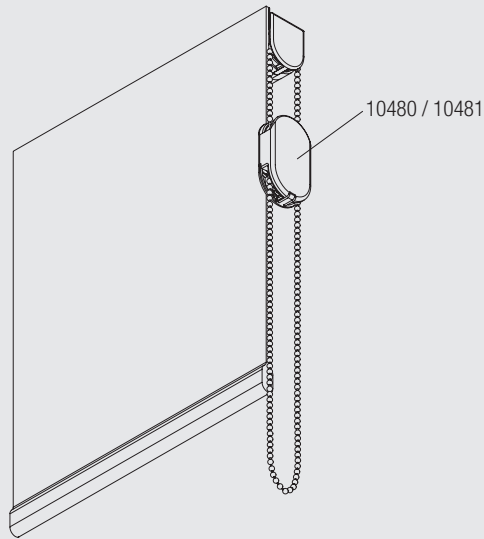

The Child Safety Device releases the chain should the pulling force exceed 6kg.

SG10480: 4.5mm metal bead chain
SG10481: 4.5mm plastic bead chain

Fitting and Sewing Information

WARNING

Young children can be strangled by loops in pullcords, chains, tapes and inner cords that operate the product. To avoid strangulation and entanglement, keep cords out of the reach of young children. Cords may become wrapped around a child's neck. Move beds, cots and furniture away from window covering cords. Do not tie cords together. Make sure cords do not twist to create a loop.

Bracket Positioning

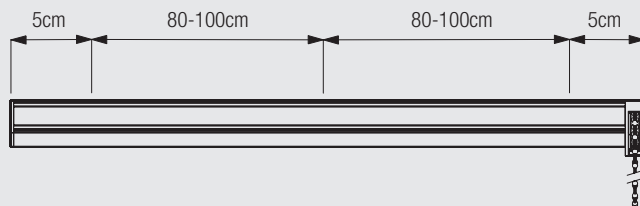

Please note: System has to be installed so chain with safety retainer 10400 ends at least 150 cm above floor!



2320

Fixing of cords / tapes

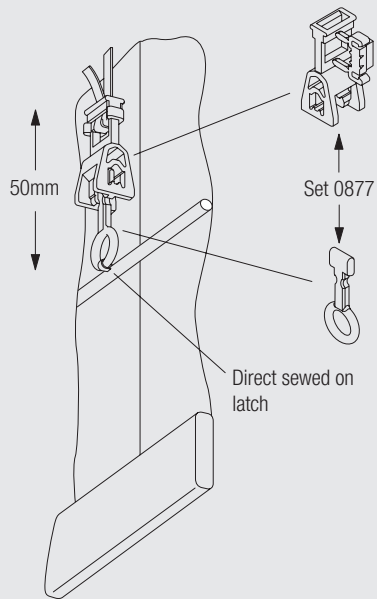

Using Breakaway Bottom Bar Set 0877

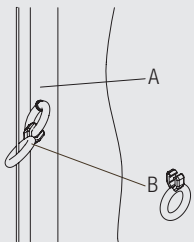

Soft fold:

A: Breakaway Ring Tape Set 0879
B: Set includes Child Safety Eyelet

Note: The Breakaway Ring Set is available without tape (part number 0878).

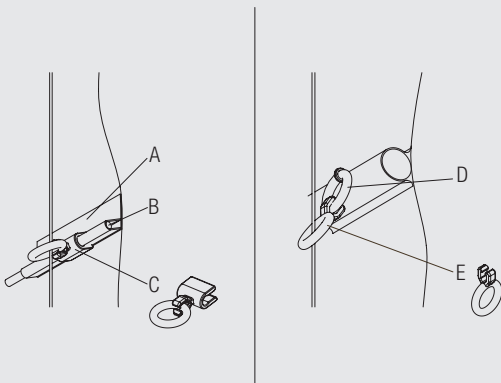

Hard fold:

A: Tape 2136
B: Steel rod 2135
C: Child Safety Eyelet (hard fold) 3069

D+E: Breakaway Set 0878

Easy Washing / Easy Maintenance through Cord Release Mechanism

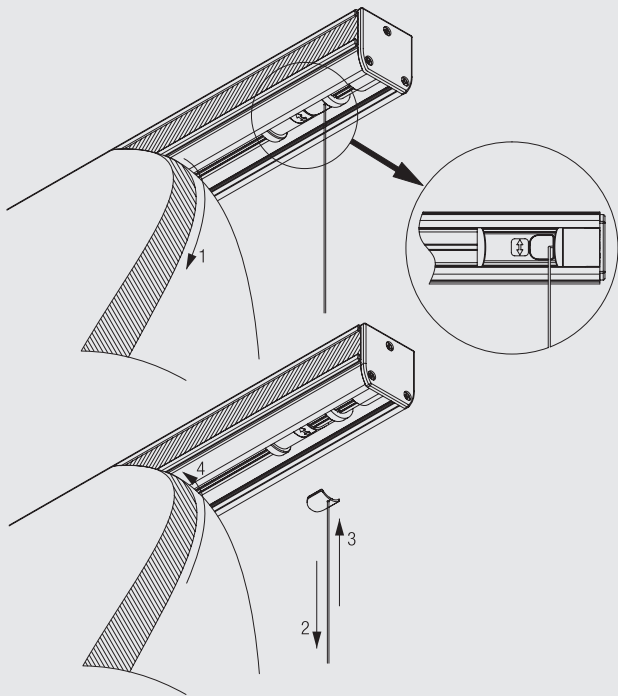

With the new developed cord release mechanism, taking down of the fabric becomes as easy as never

- 1: Remove fabric from Velcro in down position of blind
- 2: Take off the pins by pulling on the lift cord
- 3: After washing, just press pins back to the shell
- 4: Refix fabric to the Velcro tape on profile

Fitting Options

Ceiling fitting with bracket 2616

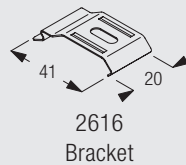
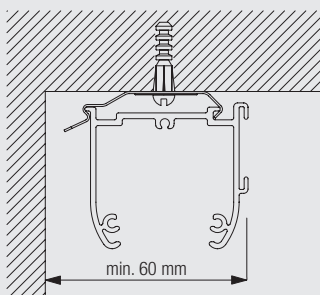

2320

Wall/ceiling fitting with wall/ceiling bracket 2343

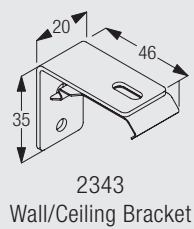
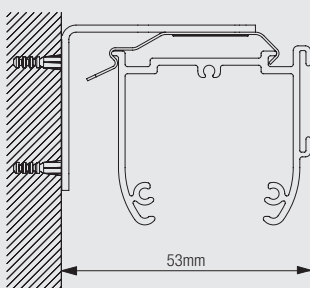

Wall fitting with brackets 3134-39 and bracket 2616

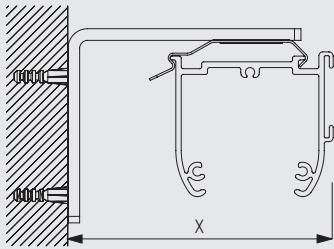

	X (mm)	W (mm)	Y (mm)	Z (mm)
3134	65	-	50	-
3135	85	-	50	50
3136	105	-	50	50
3137	125	-	80	50
3138	155	60	80	60
3139	205	85	80	85

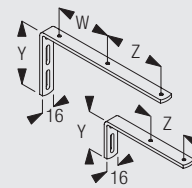

3134-39
Extension brackets
(60-200mm)

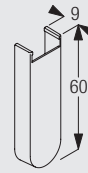

3133
Bracket cover
(60mm)

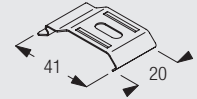

2616
Bracket

Brackets feature thread for screw M4x8 for fixing the bracket 2616

Wall fitting with adjustable bracket support 3271 / bracket plates 3272-74 and bracket 2616

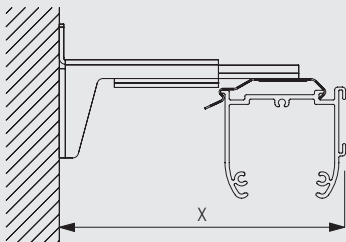

	X (mm)
3272	96-121
3273	109-144
3274	139-174

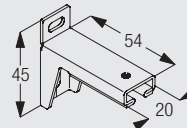

3271
Adjustable bracket
base



3272-74
Bracket arm



2616
Bracket

Brackets feature thread for screw M4x8 for fixing the bracket 2616



2320

Standard Accessories

2004 Bottom Bar



2109 Bottom ring



2216 Cord



2221 Velcro tape



2321 Profile



2322 Pin



2323 Shell



2327 Adapter



2328 Adapter



2333 Wheel for plastic bead chain



2334 White sleeve (for plastic bead chain)



2335 Drive Case 1:1







2336 Support















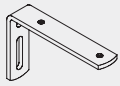
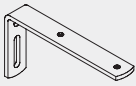
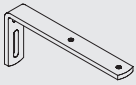
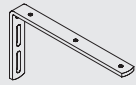

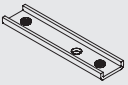
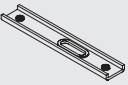
2337 End Cover



2339	Cover		2341	Wheel for steel bead chain	
2343	Wall/Ceiling Bracket		2344	Grey sleeve (for metal bead chain)	
2616	Bracket		2865	Bead chain connector	
2872	Operating chain		4845	Metal bead chain	
8214	Profile		10400	Safety Cord Retainer	





Optional Accessories

2006	Bottom Bar		2338	Wire Holder	
3133	Bracket cover (60mm)		3134	Extension bracket (60mm)	
3135	Extension bracket (80mm)		3136	Extension bracket (100mm)	
3137	Extension bracket (120mm)		3138	Extension bracket (150mm)	
3139	Extension bracket (200mm)		3271	Adjustable bracket base	
3272	Adjustable bracket arm (69mm)		3273	Adjustable bracket arm (92mm)	
3274	Adjustable bracket arm (122mm)		8235	Wire base short	
8236	Wire base long		8237	Wire holder	
8249	Locking ring		10480	Child Safety Device - 4.5mm Metal Bead Chain	
10481	Child Safety Device - 4.5mm Plastic Bead Chain		3133L	Extended bracket cover for 3137/8/9	



2320

Sewing Accessories

0877	Breakaway bottom bar set		0878	Breakaway ring set (soft fold)	
0879	Breakaway ring tape (soft fold)		2135	Steel rod	

2136 Rod Tape



2539 Velcro pile



3069 Breakaway rod cover (hard fold)



Useful Measures

2004 Bottom Bar

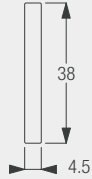

2006 Bottom Bar

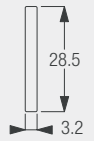

10480 Child Safety Device - 4.5mm Metal Bead Chain

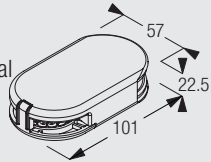

2320

Chain Operated Roman Blind System

Silent Gliss® 2330

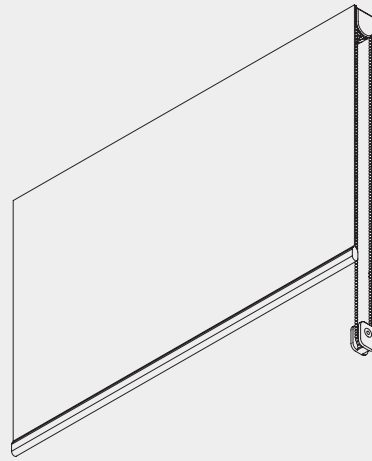

Product Information

- Chain operated (4:1 geared) roman blind system for residential and contract applications
- Suitable for small to medium size applications
- Elegant appearance
- Easy cleaning / maintenance through new cord release mechanism
- Extremely smooth and easy operation even in large dimensions
- Left or right hand operation
- The weight of the blind including the bottom weight and cross rods (if hard fold) should not exceed 4.5kg
- Easy ceiling or wall fix to all surfaces
- Side guide option available
- Plastic or steel operating chain options available
- Compliant with Child Safety Legislation (EN13120)



2330

Profile, Bending and Specification Information

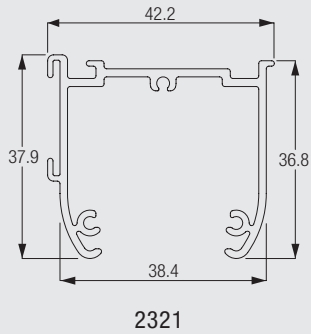

Cannot be bent.

Specification Guide - download from www.silentgliss.co.uk (password required).

Silent Gliss Roman/Austrian headrail system 2321 with bonded velcro 2221 insert in white. Fabric to be attached to profile using pile section velcro. Profiles to have endcovers 2337/2339. Blind to be lifted using cord 2216 attached to profile 8214 using cord release mechanism 2322/2323. Bead chain operation, left/right hand pull via gear drive 2326. Top/face fix using 2343 universal bracket at 80cm centres.

How to Measure

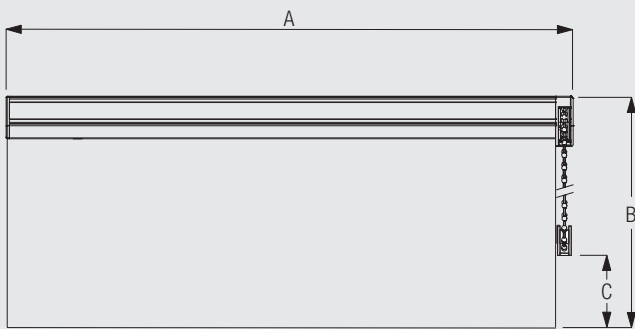

A: System length
B: System height



2330

System Dimensions



3.0m



3.0m



4.5kg

The system dimensions depend on the total fabric weight including the bottom weight bar.

A gear drive (2326) will be built in. This will slow down the up/down movement of the blind (ratio 4:1), but ensures a comfortable operation for the user.

System Option Side guide

Side guides for stabilizing and sloping applications (up to 15°)

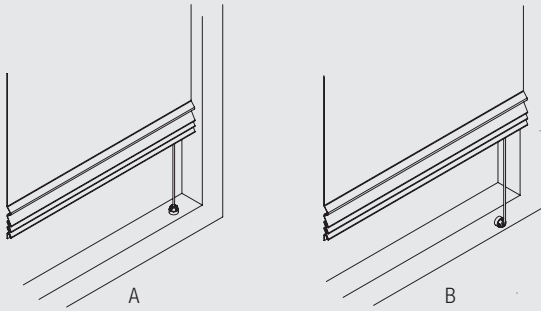

- A: Fitting of side guides inside window frame
- B: Fitting of side guides onto front of window frame

Fitting of side guides inside window frame or onto front of window frame. The system 2330 can be equipped with side-guide wires (0776) and can therefore also be used for sloping applications up to 15° inclination.

Child Safety Device

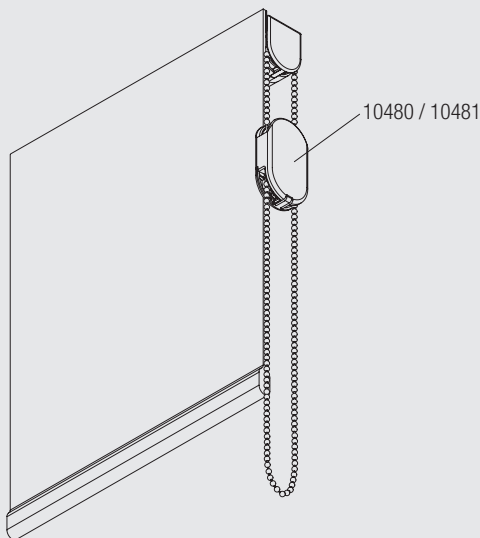

The Silent Gliss Child Safety Device releases the chain should the pulling force exceed 6kg.

- 10480: Metal bead chain 4.5mm
- 10481: Plastic bead chain 4.5mm



2330

Fitting and Sewing Information

WARNING

Young children can be strangled by loops in pullcords, chains, tapes and inner cords that operate the product. To avoid strangulation and entanglement, keep cords out of the reach of young children. Cords may become wrapped around a child's neck. Move beds, cots and furniture away from window covering cords. Do not tie cords together. Make sure cords do not twist to create a loop.

Bracket Positioning

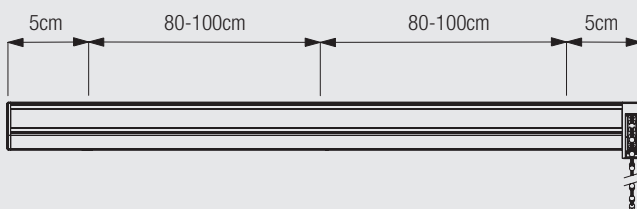

Please note: System has to be installed so chain with safety retainer 10400 ends at least 150 cm above floor!

Fixing of cords / tapes

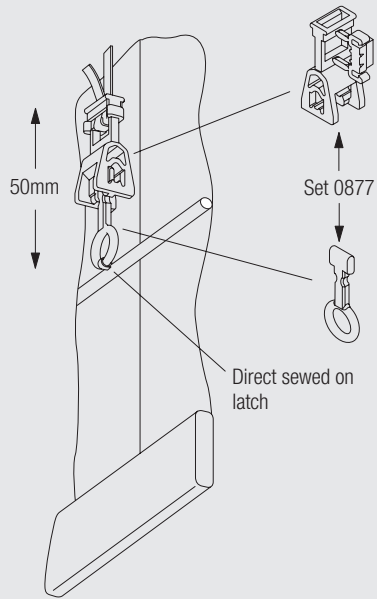

Using Breakaway Bottom Ring Set 0877

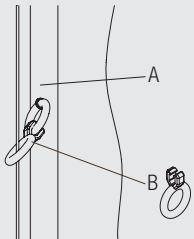

Soft fold:

- A: Breakaway Ring Tape Set 0879
- B: Set includes Child Safety Eyelet

Note: The Breakaway Ring Set is available without tape (part number 0878).



2330

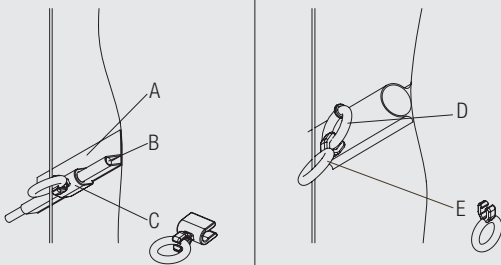

Hard fold:

- A: Tape 2136
- B: Steel rod 2135
- C: Child Safety Eyelet (hard fold) 3069

D+E: Breakaway Ring Set 0878

Easy Washing / Easy Maintenance through Cord Release Mechanism

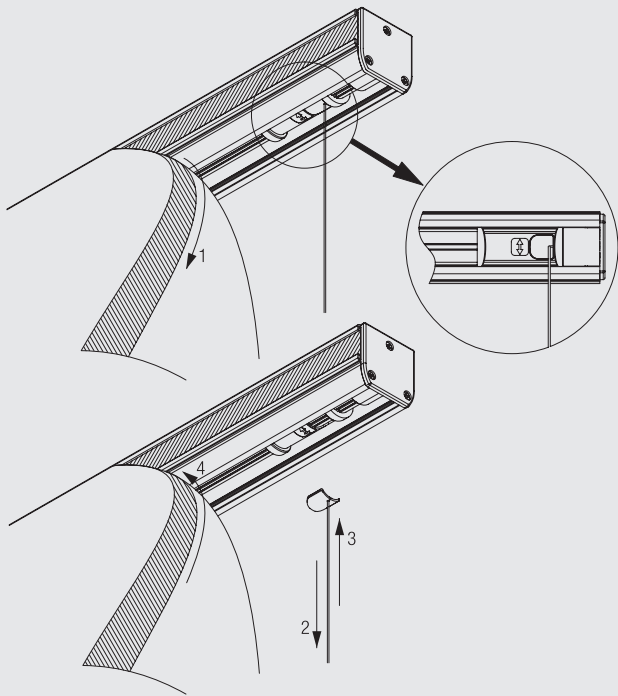

With the new developed cord release mechanism, taking down of the fabric becomes as easy as never

- 1: Remove fabric from Velcro in down position of blind
- 2: Take off the pins by pulling on the lift cord
- 3: After washing, just press pins back to the shell
- 4: Refix fabric to the Velcro tape on profile

Fitting Options

Ceiling fitting with bracket 2616

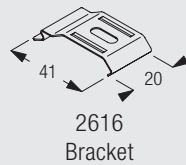
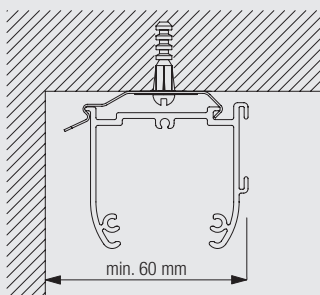

2330

Wall/ceiling fitting with wall/ceiling bracket 2343

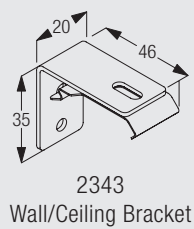
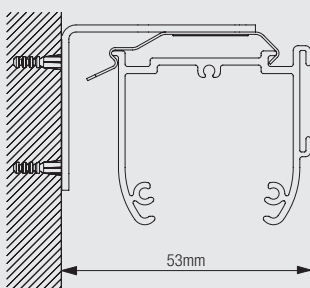

Wall fitting with brackets 3134-39 and bracket 2616

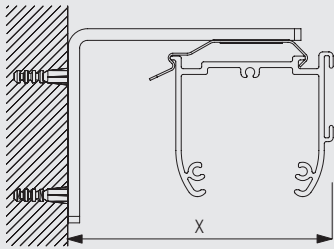

	X (mm)	W (mm)	Y (mm)	Z (mm)
3134	65	-	50	-
3135	85	-	50	50
3136	105	-	50	50
3137	125	-	80	50
3138	155	60	80	60
3139	205	85	80	85

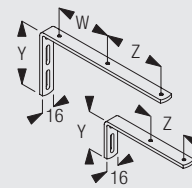

3134-39
Extension brackets
(60-200mm)

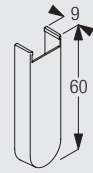

3133
Bracket cover
(60mm)

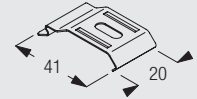

2616
Bracket

Brackets feature thread for screw M4x8 for fixing the bracket 2616

Wall fitting with adjustable bracket support 3271 / bracket plates 3272-74 and bracket 2616

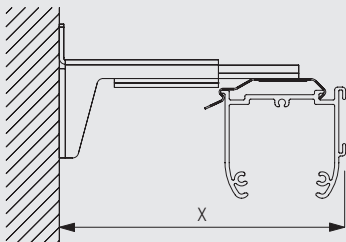

	X (mm)
3272	96-121
3273	109-144
3274	139-174

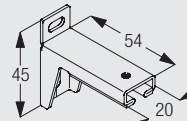

3271
Adjustable bracket
base



3272-74
Bracket arm

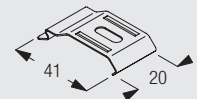

2616
Bracket

Brackets feature thread for screw M4x8 for fixing the bracket 2616





2330

Standard Accessories

2004 Bottom Bar 

2047 Driving sleeve 

2216 Cord 

2321 Profile 

2323 Shell 

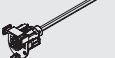
2326 Drive Case 4:1 

2329 Adapter 

2046 Driving pulley 

2109 Bottom ring 









2221 Velcro tape 

2322 Pin 













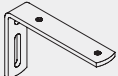

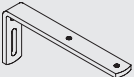
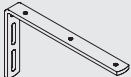

2325 Cover 

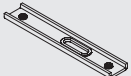
2327 Adapter 







2336 Support 

2337	End Cover		2343	Wall/Ceiling Bracket	
2616	Bracket		2865	Bead chain connector	
2872	Operating chain		4845	Metal bead chain	
8214	Profile		10400	Safety Cord Retainer	

Optional Accessories

2006	Bottom Bar		2338	Wire Holder	
3133	Bracket cover (60mm)		3134	Extension bracket (60mm)	
3135	Extension bracket (80mm)		3136	Extension bracket (100mm)	
3137	Extension bracket (120mm)		3138	Extension bracket (150mm)	
3139	Extension bracket (200mm)		3271	Adjustable bracket base	
3272	Adjustable bracket arm (69mm)		3273	Adjustable bracket arm (92mm)	
3274	Adjustable bracket arm (122mm)		8235	Wire base short	
8236	Wire base long		8237	Wire holder	
10480	Child Safety Device - 4.5mm Metal Bead Chain		10481	Child Safety Device - 4.5mm Plastic Bead Chain	
3133L	Extended bracket cover for 3137/8/9				

Sewing Accessories

0877	Breakaway bottom bar set		0878	Breakaway ring set (soft fold)	
0879	Breakaway ring tape (soft fold)		2135	Steel rod	
2136	Rod Tape		2539	Velcro pile	

3069 Breakaway rod cover (hard fold)



Useful Measures

2004 Bottom Bar



2006 Bottom Bar

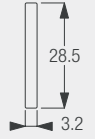

10480 Child Safety Device - 4.5mm Metal
Bead Chain

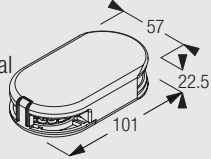

2330