

BC

# ExtremeController

Model: SEI-SELEDZ4

# 4-ZONE LED CONTROLLER



## User Guide

# Introduction

---

- Please read the User Guide before installation and use.
- The ExtremeController is compatible with the ECOXGEAR audio and LED lighting EcoSystem, which includes LEDCast and EcoCast Innovations. Look for the LEDCast and EcoCast logos on the growing family of ECOXGEAR and SoundExtreme audio and lighting solutions.
- The ExtremeController has four Zone LED Control Outputs. Each Zone supports a maximum power output of 5A. Thus, the total current consumption on the power supply to the ExtremeController depends on how many LEDs are connected to the controller. The maximum current draw is 20A if four 5A units are connected to the controller **AND** are all lit up at the same time.
- Please refer to specifications of your SoundExtreme LED product when you analyze the current-draw requirements of your power supply.
- The voltage for the power input is +12VDC. You need to connect to a 12VDC power supply. If your vehicle battery power is not 12V (e.g., 24V, 36V, or 48V), you will need a DC-DC voltage converter with 12V output (e.g. a 48V-to-12V converter). Connecting the ExtremeController directly to higher voltages will cause damage to the controller and **VOID THE PRODUCT WARRANTY**.
- The ExtremeController has a Remote Turn-On Input feature; this is to ensure that the controller is completely powered off (no battery consumption) when your vehicle is not in use. When the input has a signal between 12V to 56V, the controller will turn on. When there is no input voltage, the controller will turn off. In general, this Remote Turn-On signal comes from the vehicle ignition switch.
- The ExtremeController has 4 Vehicle Signal Inputs (left turn, right turn, brake, and reverse). When you connect the controller to these inputs, only LED products that are connected to Zones 3 and 4 will be affected. If you are not sure where these signal wires are located on your vehicle, consult your vehicle's manual

or a technician. Incorrect connections to your vehicle may cause your controller or your vehicle to malfunction. Please note that the maximum voltage for these 4 Vehicle Signal Inputs is 12VDC.

- The ExtremeController can be controlled by the included RF Remote or a free SoundExtreme Smartphone App available on the Apple App Store and Google Play Store.
- The ExtremeController can support multiple types of SoundExtreme LED products. All 4 Zones come preset to the 6' ExtremeWhip. To optimize the LED light performance the first time you use the controller, or you make LED Zone connection changes after the initial set up, please use the SoundExtreme Smartphone App to choose the LEDCast product that is connected to each Zone.
- The ExtremeController Music Modes work with ECOXGEAR or SoundExtreme products with EcoCast wireless capability. When an LED Zone output is set to Music Mode, the controller needs to wirelessly connect to an EcoCast-enabled audio product.
- Do **NOT** make modifications to the ExtremeController LED connectors or try to connect this product to other manufacturers' LED products. It may cause permanent damage to the product and **VOID THE PRODUCT WARRANTY**.

# ExtremeController Overview

## ExtremeController Layout

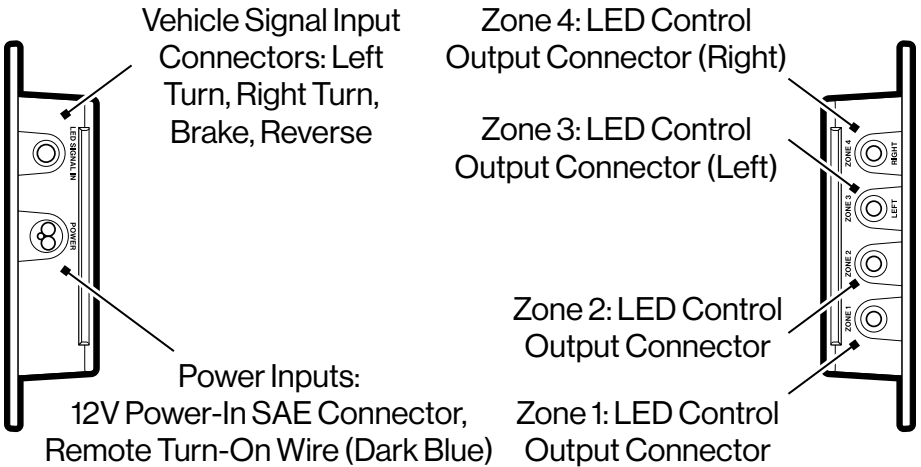
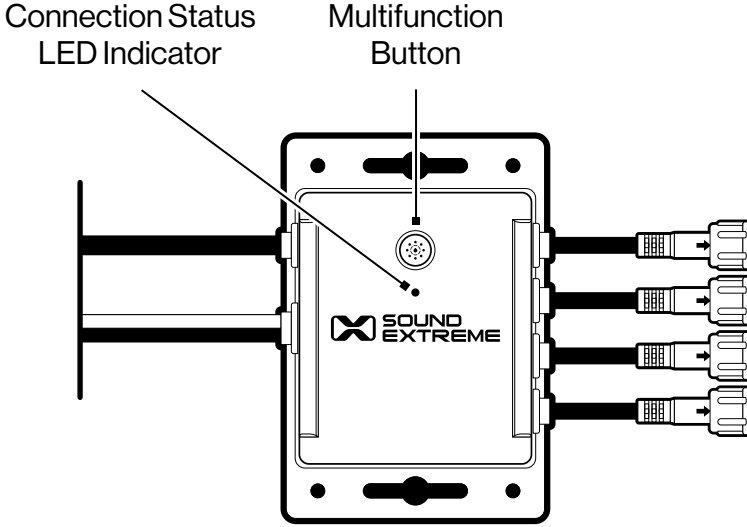

## Button & Connectors

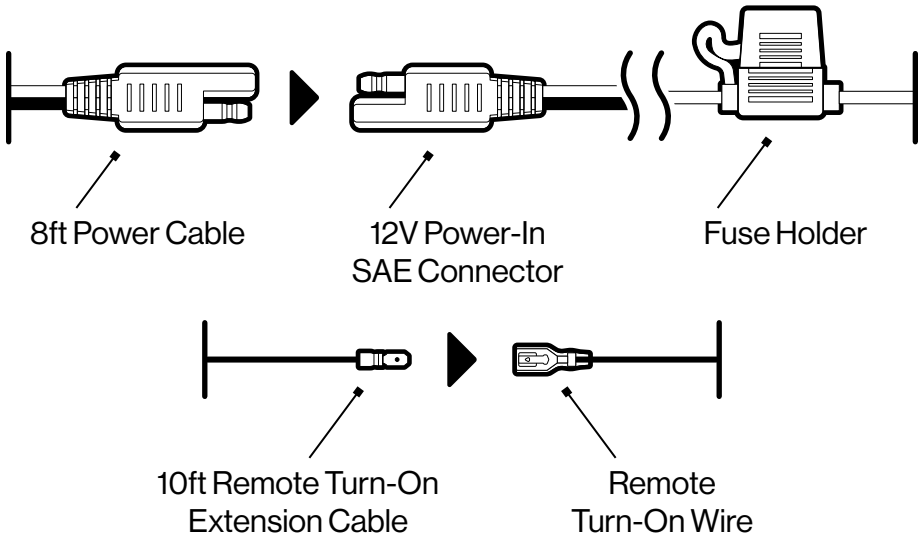

**Power Input Connector:** Power-In SAE Connector (+12V and GND), Remote Turn-On Wire (Dark Blue).

- The Power-In SAE cable has an in-line 25 Amp Fuse Holder.
- Also included are an 8ft SAE Power Cable and a 10ft Remote Turn-On Extension Cable (Dark Blue).

Vehicle Signal Input Connectors: Left Turn, Right Turn, Brake, Reverse

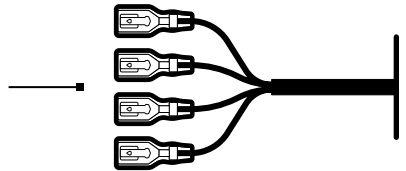

**Vehicle Signal Input Connectors:** Connect to the vehicle for left turn, right turn, brake, and reverse lighting integration. (This connection is optional; however, you won't be able to use the Vehicle Signaling Features on your LED product without it.)

**Multifunction Button:** The  Button has 3 functions.

1. Short-Press: Re-enable EcoCast audio pairing for LED Music Mode.

# ExtremeController Overview

---

2. Double-Click: Enable RF Remote Control pairing.

- The included Remote Control already comes paired and is automatically connected to the ExtremeController.
- This feature is meant to be used if the connection is lost or a replacement Remote Control is purchased.

3. Press and Hold for 3 seconds: Clears the EcoCast pairing records.

**Connection Status LED Indicator:** The LED indicates 3 possible Connection Statuses.

1. Flashing Blue: The ExtremeController is in Remote Control Pairing Mode.
2. Flashing Green: The ExtremeController is searching for an EcoCast Transmitting device to pair and connect to.
3. Solid Green: The ExtremeController is connected to an EcoCast Transmitting device.

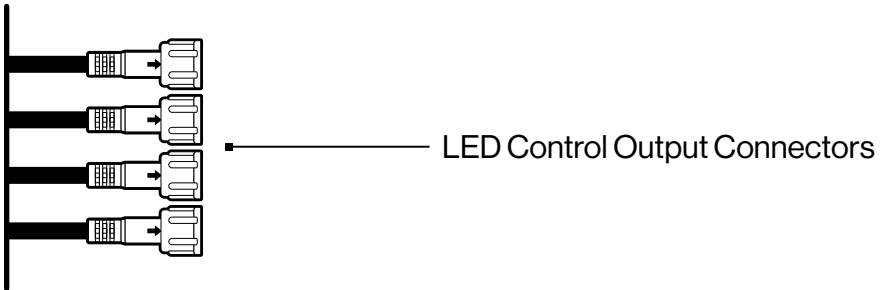

**LED Control Output Connectors:** Connect SoundExtreme LED products to each of the 4 Zone Control Outputs.

- All 4 Zone Outputs have the same electric specifications.
- Only Zones 3 and 4 integrate with the Vehicle Signal Inputs, allowing the connected LEDs to function as enhanced brake, reverse, and turn signal lights.

## Connecting to 12VDC Power Supply

The ExtremeController does not have an internal battery. It must be connected to an external 12VDC power supply to function. When you install the ExtremeController to a battery or a voltage regulator on a golf cart, a boat, a quad bike, a UTV, or another vehicle, you need to make sure that your vehicle battery or battery pack terminal voltage is 12VDC. If the battery terminal voltage is not 12V, you will need a DC–DC converter with output 12V. Connecting the ExtremeController to a non-12VDC power source will lead to a malfunction or damage to the controller.

**Note:** Besides the power supply, the ExtremeController relies on the Remote Turn-On Signal Input to turn on and off. Refer to **Connecting the Remote Turn-On Input Wire to a Switch** for more details.

### Installation: 12V Power-In SAE Connector



1. Attach the 8ft Power Cable to the 12V Power-In SAE Connector.

**Use Caution:** Do **NOT** connect to 12V Battery if the Power In SAE Connector is wet. Contact may cause electric shock and injury if wet.

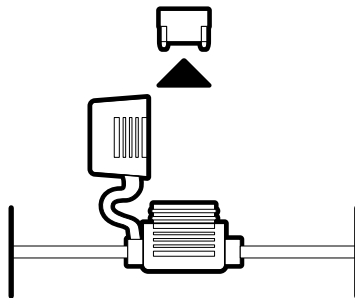

2. Remove the 25 Amp Blade Fuse from the Fuse Holder.

# Installation and Wiring

**Use Caution:** Do **NOT** remove Fuse if the Fuse Holder is wet. An improperly fitted cap may cause electric shock and injury if wet.

3. To close properly, push firmly to be sure the cap snaps into place.
4. Next follow either the **Gas Vehicle** or **Electric Vehicle** Installation instructions.

## Installation: Gas Vehicle

1. Loosen the bolts on the battery terminals.

**Use Caution:** Do **NOT** attempt to loosen bolts if battery is wet. Contact may cause electric shock and injury if wet.

2. Connect the **BLACK** wire to the **BLACK**, negative terminal, then the **RED** wire to the **RED**, positive terminal. Unit will not work correctly and may be damaged if wires are not correctly attached.
3. Tighten the bolts on the battery terminals until the connectors are held firmly in place.
4. Return the 25 Amp Blade Fuse into the Fuse Holder and close the cap.

**Tip:** Use zip ties to gather any excess wires, and secure them so that they are not dangling, loosely.

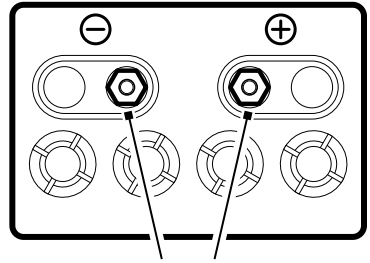

Loosen Bolts

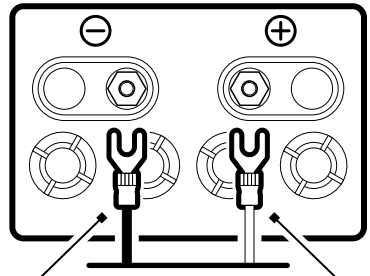

Black Cable      Red Cable

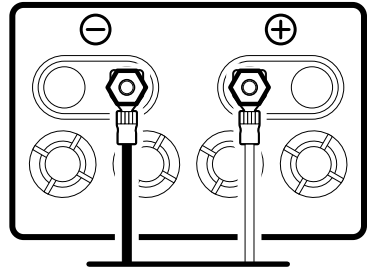

Tighten Bolts

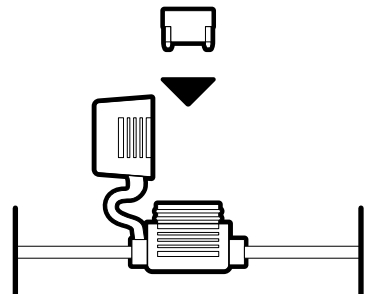



## Installation: Electric Vehicle

1. Switch your vehicle to Tow mode, if available.
2. Wire the **BLACK** wire to the **GROUND** on output of the DC-DC Converter.
3. Wire the **RED** wire to the **POSITIVE (+)** post on the output of the DC-DC converter. Unit will not work correctly and may be damaged if wires are not correctly attached.
4. Return the 25 Amp Blade Fuse into the Fuse Holder and close the cap.

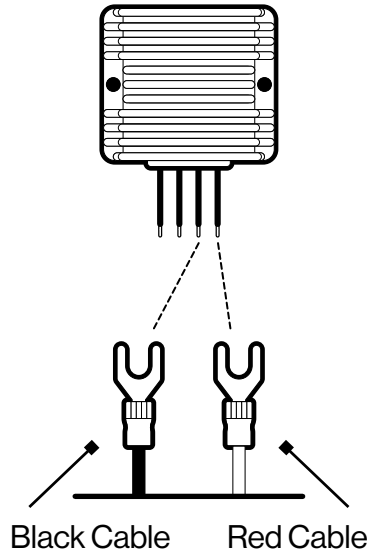

**Use Caution:** Do **NOT** connect to DC-DC converter if the 8ft Power Cable or the Power-In SAE Connector are wet. Contact may cause electric shock and injury if wet.

**Tip:** Use zip ties to gather any excess wires, and secure them so that they are not dangling, loosely.

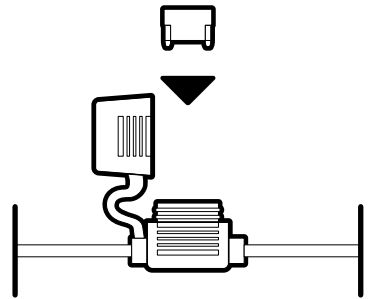

## Connecting the Remote Turn-On Input Wire to a Switch

Besides the 12V power supply, the ExtremeController relies on the Remote Turn-On Signal Input to turn on and power off. The input voltage range to turn on is 12V to 56V. When the input voltage is 0, it will power off the controller.

You will need to connect the (Dark Blue) Remote Turn-On Wire to the vehicle ignition switch with the supplied (Dark Blue) Remote Turn-On Extension Cable. If you are not able to connect it to your vehicle ignition switch, connect this input to a rocker switch (not

# Installation and Wiring

included), then connect the rocker switch to a 12V to 56V power supply on your vehicle or to a switch accessory panel.

**WARNING:** The RF Remote Control does **NOT** turn off the ExtremeController. The Remote only turns off the connected LEDs. To prevent draining your vehicle's battery, you must turn the vehicle ignition off or the rocker switch off.

## Connecting to a Switch

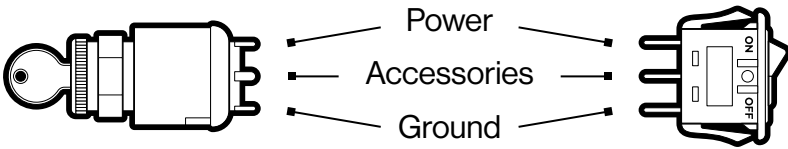

To connect the ExtremeController to your vehicle's ignition switch or a rocker switch, follow the steps below:

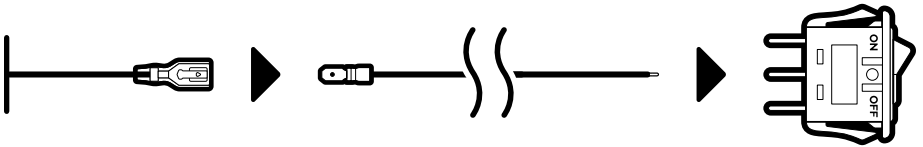

1. Connect the (Dark Blue) Remote Turn-On Wire to the Accessories terminal of your switch with the supplied (Dark Blue) Remote Turn-On Extension Cable.

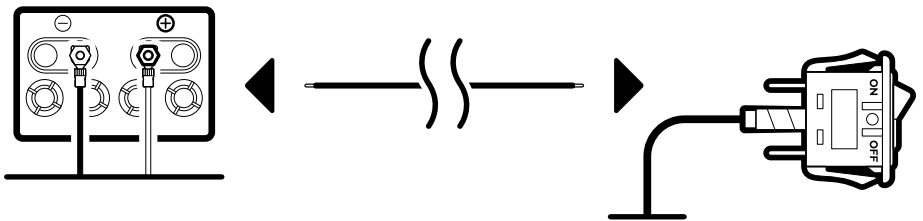

2. Connect the Power terminal of your switch to your vehicle's (12V - 56V) power supply terminal with a cable that comes with your switch.

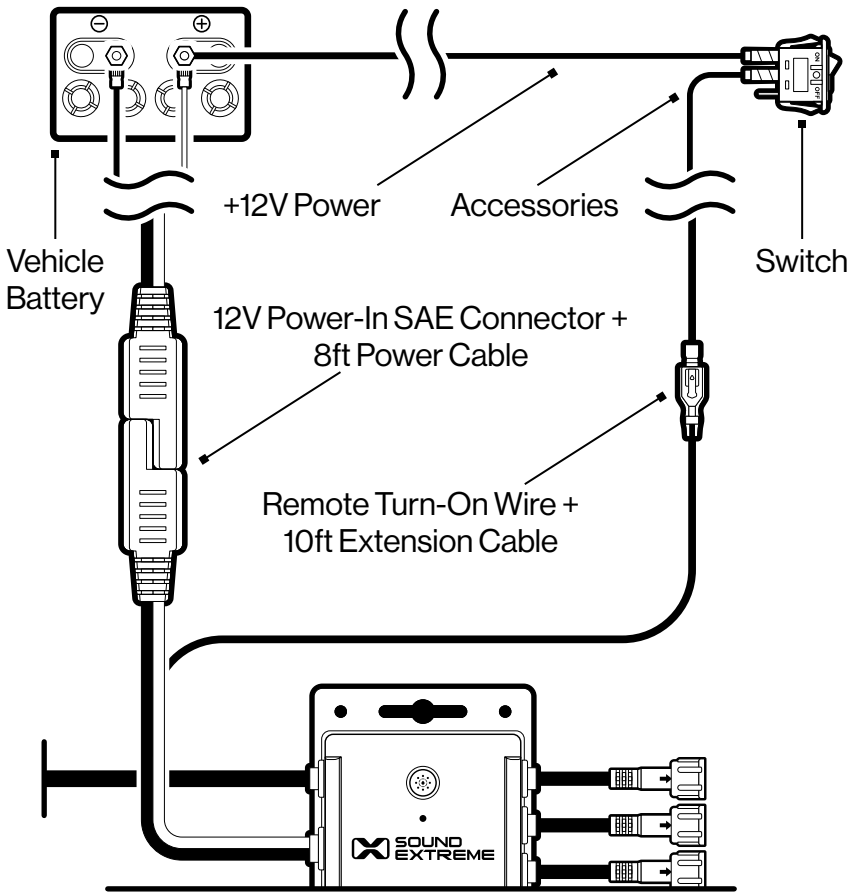

3. Once the connections are completed, the ExtremeController will turn on or off when the switch is turned on or off.

## Connecting to a Power Panel or Switch Panel

If your vehicle has an accessory power panel or switch panel, you can use a connection on the panel to turn the ExtremeController on or off with the following steps:

1. Find a terminal on the panel that has 12VDC - 56VDC output when the switch is on and 0VDC output when the switch is off.

# Installation and Wiring

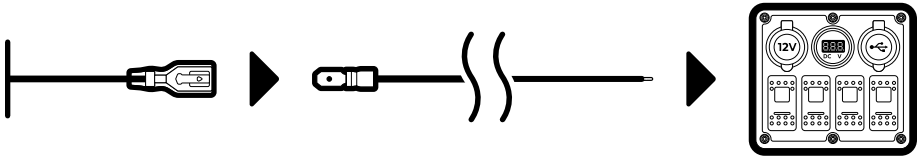

2. Connect the (Dark Blue) Remote Turn-On Wire to the switch terminal with the supplied (Dark Blue) Remote Turn-On Extension Cable.

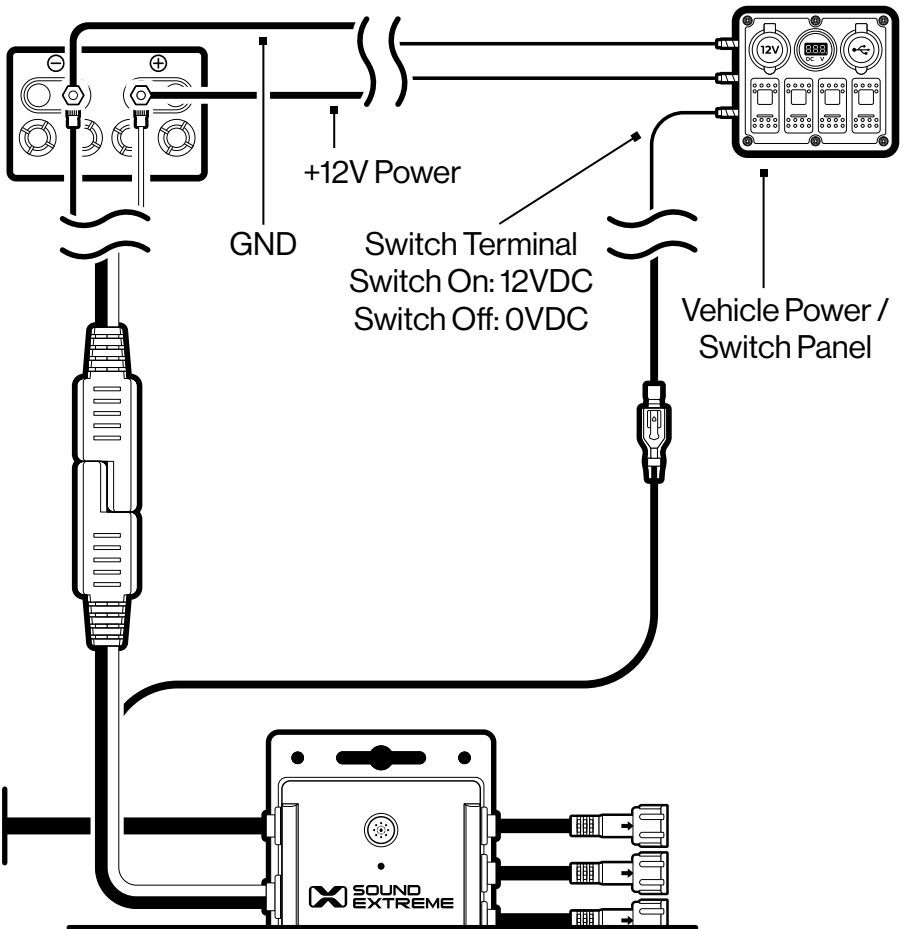

3. Once the connection is completed, when the vehicle is on, the ExtremeController will turn on or off when the panel is turned on or off.

**Recommendation:** If you are not familiar with all of the switch connections on the panel, consult your switch accessory panel's manual or a technician. Incorrect connections to your panel may cause your controller or your panel to malfunction.

## Connecting LEDCast-Enabled Products

1. Once the 12V Power and Remote-Turn On Input connections have been made, turn on the vehicle ignition switch (or the rocker switch). The Connection Status LED Indicator will flash Blue, indicating a successful power connection. If not, check the ExtremeController wirings.
2. Now, turn off the vehicle ignition switch (or the rocker switch) to turn off the ExtremeController. To avoid potential damage to the product, you **MUST** disconnect the SAE Power Cable from the controller before connecting a SoundExtreme LED product to it.
3. Connect LEDCast-enabled products to any of the 4 LED Control Outputs. The following is an example configuration by Zone:
  - Zone 1: ExtremeStrip – Roof.
  - Zone 2: ExtremeStrip – Underglow.
  - Zone 3 (left): ExtremeWhip installed on the vehicle's left side.
  - Zone 4 (right): ExtremeWhip installed on the vehicle's right side.

Run the LED control cable from the LEDCast-enabled product to the ExtremeController, making sure the cable does **NOT** touch any moving parts on the vehicle. If the cable is longer than required, do **NOT** cut the cable and reconnect. Instead, wrap the extra length on your vehicle and fasten the cable with zip ties. Please ensure the cable does **NOT** touch or drag on the ground **AND** is safely secured to prevent it from coming into contact with any moving parts.

# Installation and Wiring

---

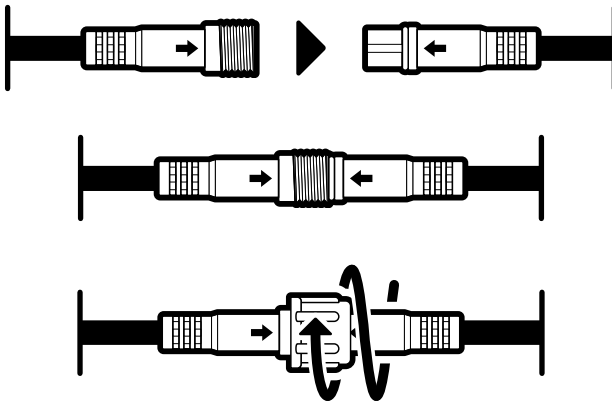

4. To connect the cables connect the 3-pin female connector on the control cable to the 3-pin male connector on a LEDCast-enabled product. Align the arrow on both connectors, push in and screw the nut cap on the female connector.

Connect the 3-pin male connector on the control cable to the LED control output 3-pin female connector on the ExtremeController.

5. **Optional:** Integrate with the Vehicle Signal Inputs.

If you are familiar with all of your vehicle's signal input connections, you can connect the Vehicle Signal Input Control Connectors to your vehicle's turn, brake, and reverse wires (connection cables between the ExtremeController and your vehicle signal are not included) to add the Street Mode function to Zone 3 and 4.

- Pink Wire: Reverse Signal
- Orange Wire: Brake Signal
- Green Wire: Left Turn Signal
- Blue Wire: Right Turn Signal

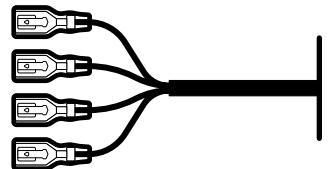

**Recommendation:** If you are not sure where these signal wires are located on your vehicle, consult your vehicle's manual or a technician. Incorrect connections to your vehicle may cause your controller or your vehicle to malfunction.

**IMPORTANT:** After you complete all the wiring and turn on the ExtremeController for the first time, test for proper wiring and function as follows:

- Turn vehicle's left turn signal on: LED's connected to Zone 3 will flash Yellow.
  - Turn vehicle's right turn signal on: LED's connected to Zone 4 will flash Yellow.
  - Press the vehicle's brake: LED's connected to Zone 3 and 4 will shine Red.
  - Carefully put your vehicle in reverse: LED's connected to Zone 3 and 4 will shine White.
6. Wiring is now complete. When power is provided to the ExtremeController, use the included RF Remote Control or SoundExtreme Smartphone App to control the system.

# Lighting Control Concepts

---

## Zones

A Zone corresponds to all of the LED lights that are connected directly to one physical LED Control Output on the ExtremeController. When you change a Zone status (On/Off, Mode, etc.), the LEDs connected to that Zone will change accordingly. You can control one Zone or multiple Zones at a time.

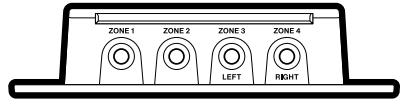

## Modes

There are 3 LED Mode categories, totaling in 44 Modes supported by the RF Remote. The SoundExtreme app can support many more Color Modes.

1. **Color Mode:** Each Color Mode lights up the LEDs in a solid color. There are 8 Color Buttons on the Remote Control: Red, Green, Blue, White, Orange, Yellow, Cyan, and Purple. You can create a custom color by utilizing the SoundExtreme Smartphone App.
2. **Party Mode:** There are 20 preset Party Modes accessible via the Remote Control and SoundExtreme Smartphone App. The app allows you to customize each of the 20 Party Modes, allowing for nearly unlimited color, cascading, and LED chasing options.
3. **Music Mode:** There are 16 Music Modes accessible via the Remote Control and SoundExtreme Smartphone App. In order to sync with the music, the ExtremeController must be wirelessly connected to an EcoCast-enabled ECOXGEAR or SoundExtreme audio product. Refer to **EcoCast for Music Mode** for more information.

## Scene

A Scene is programmed via the SoundExtreme Smartphone App. You can customize each Zone into a Scene (a preset). Setting the Scenes on the app allows a 1-button press to bring up your desired custom settings for all of the LED products connected to the ExtremeController.



The ExtremeController supports 6 lighting Scenes. Scenes 1-5 are user customizable and programmable. The 6th scene, Street Mode, is for special use and cannot be modified. The default Scene settings are:

- Scene 1: Orange for all 4 Zones.
- Scene 2: Flowing colors for all 4 Zones.
- Scene 3: Patriot 1 for all 4 Zones.
- Scene 4: Fading colors for all 4 Zones.
- Scene 5: Christmas for all 4 Zones.
- Scene 6: Street Mode – Turns all LED lights off but keeps the controller powered on so Zones 3 and 4 will still function as enhanced brake, reverse, and turn signal lights.

## **Street Mode: Zone 3 and 4 Vehicle Signaling**

If you have Integrated the ExtremeController with the Vehicle's Signal Inputs, you can use the Street Mode function.

Under normal operations, when all 4 Zones are turned off, the vehicle signaling in Zones 3 and 4 automatically enters Off Mode.

When LEDs in any of the 4 Zones are turned on, as soon as the controller has a vehicle's signal input, Zone 3 and 4 LEDs will light up accordingly. The LEDs will resume their original status (an LED Mode) once the vehicle signal input is gone.

You can also use the RF Remote Control to turn the LED lights in all 4 Zones on or off (when the controller has a vehicle's Remote Turn-On Signal Input). Simply press the **ALL** Button to turn the LEDs in all 4 Zones on or off. When the LEDs in all 4 Zones are turned off, the controller has the following two functions:

- Off Mode: When the LEDs in all 4 Zones are turned off, the controller disables the vehicle signaling to the LEDs in Zones 3 and 4, i.e. Zone 3 and 4 LEDs will not light up, even if there is a vehicle

# Lighting Control Concepts

---

signal input. This Off Mode is for users who do not want their LEDs to light up while they are driving.

- **Street Mode:** When the controller is in this Mode, all 4 Zone LEDs are also turned off. However, as soon as the controller has a vehicle's signal input, the LEDs in Zone 3 and 4 will light up accordingly. The LEDs will turn off once the vehicle signal input is gone.

To enable Street Mode, press the **Scene** Button on the Remote to cycle through to the 6th Scene or use the SoundExtreme Smartphone App and select Scene 6 – Street Mode.

When the ExtremeController enters Street Mode, each of the LEDs in all 4 Zones will briefly light up Blue in ascending order to indicate that Street Mode is active.

When the ExtremeController is in Street Mode, any Mode change to a Zone (e.g. change Zone 1 Color) or Scene change will bring the controller out of Street Mode and into the selected setting.

When the controller exits Street Mode, each of the LEDs in all 4 Zones will briefly light up Blue in descending order.

## EcoCast for Music Mode

The ExtremeController is compatible with the ECOXGEAR audio and LED lighting EcoSystem, which includes LEDCast and EcoCast Innovations. Look for the LEDCast and EcoCast logos on the growing family of ECOXGEAR and SoundExtreme audio and lighting solutions. EcoCast-enabled audio products are designed to be paired with one or more EcoCast-enabled products. Simply initiate EcoCast Transmitting Mode in one SoundExtreme or ECOXGEAR speaker and broadcast your music to one or more EcoCast-enabled products in Receiving Mode. Once connected to your controller, select a Music Mode to have all of your LED lights complement the music.

**Note:** The ExtremeController is always in EcoCast Receiving Mode.

## EcoCast: Speaker to ExtremeController

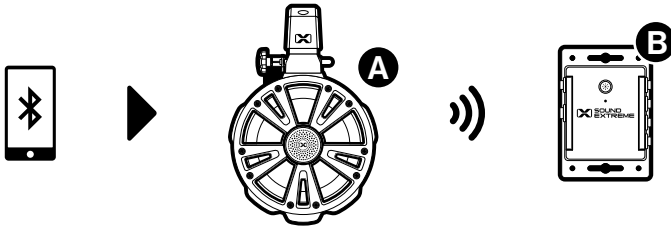

1. Follow the **Pairing a Bluetooth Device** instructions in your speaker's user guide to connect it (**Speaker A**) to your Bluetooth device. After your device is connected to **Speaker A**, you can select a song to play.
2. Initiate EcoCast Transmitting Mode on **Speaker A**.
3. Power on your ExtremeController (**Controller B**). It will already be in EcoCast Receiving Mode. The Connection Status LED Indicator will flash Green.
4. Once the connection between the products is successful, the Connection Status LED Indicator on **Controller B** will shine solid Green. You can now select one of the 16 Music Modes with the Remote Control or the SoundExtreme Smartphone App.

## EcoCast: Additional Receiving Speakers and / or Controllers

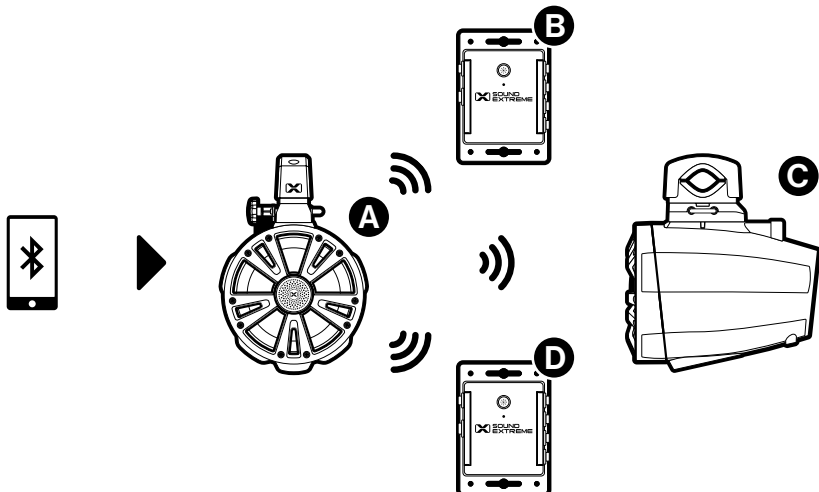

# Lighting Control Concepts

---

1. Power on the additional EcoCast-enabled products (**Speaker C** and **Controller D**) and initiate EcoCast Receiving Mode in **Speaker C (Controller D** will already be in EcoCast Receiving Mode). The Connection Status LED Indicator on **Controller D** will flash Green.
2. Reinitiate EcoCast pairing on **Speaker A**.
3. Once the connection between the speakers is successful, the Connection Status LED Indicator on **Controller D** will shine solid Green. You can now select one of the 16 Music Modes.

## Notes:

- If all the speakers are turned off, then turned on, the speaker(s) and controller(s) in EcoCast Receiving Mode (**Speakers** and **Controllers B, C, and D**) will automatically re-connect to the speaker in Transmitting Mode (**Speaker A**). If they are not automatically re-connected, please follow the above steps.
- To clear pairing records on an ExtremeController, **PRESS AND HOLD**  for 3 seconds.
- If the ExtremeController is unable to pair and connect with the speaker, re-enable the EcoCast pairing on the speaker, then **PRESS AND HOLD** the **ALL** Button on the RF Remote Control to enable EcoCast pairing on the controller.
- The EcoCast functionality is only available while using Bluetooth as your Audio Source on legacy ECOXGEAR products at a maximum range of 30 feet between speakers.
- While connecting the EcoCast-enabled products, make sure that they are within a few feet of each other.

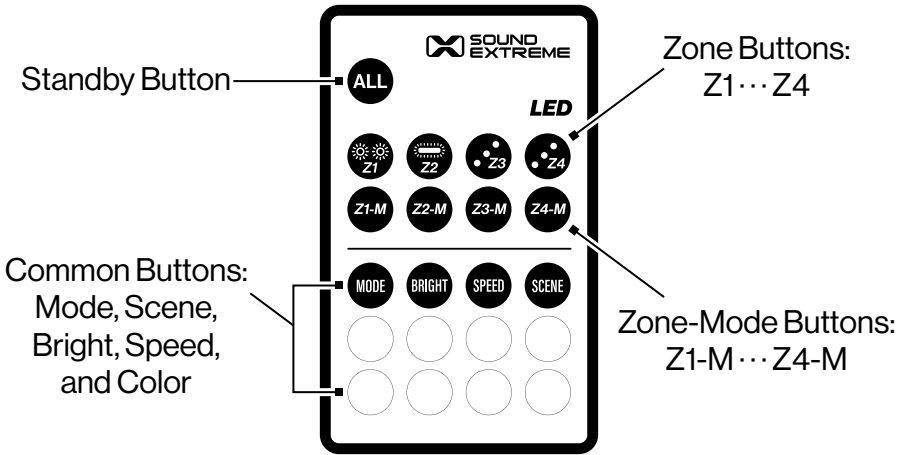

The RF Remote Control comes paired to the ExtremeController.

If the ExtremeController does not react when you press a button on the Remote Control, check if the battery isolator (clear plastic strip) on the Remote battery compartment is removed (pulled out) completely. Then, power off and power on the ExtremeController. When the Connection Status LED Indicator on the controller flashes Blue, **PRESS AND HOLD** the Mode Button on the Remote for 3 seconds. The Status LED Indicator will shine solid Green for 1 second, then flash Green, indicating a successful pair.

## Basic Functions

1. Turn on the vehicle ignition switch (or the rocker switch) to power on the ExtremeController.
2. Press the **ALL** Button to turn on the LEDs in all of the Zones. Each of the LEDs will briefly light up Green in ascending order and then shine solid Orange or a random color pattern.
3. If you don't see the LEDs light up, as a test, short-press the Red Button. The LEDs in all the Zones will shine solid Red.

# RF Remote Control

---

4. There are three ways to change the LED Mode:

- Short-press the Mode Button to cycle through the three LED Mode categories for all the Zones.
- Short-press one of the 8 Color Buttons to light the LEDs in all the Zones in the corresponding color.
- Short-press one of the Zone-Mode Buttons (Z1-M, Z2-M, Z3-M, or Z4-M) to cycle through the three LED Mode categories for only the corresponding Zone.

**Note:** There are 44 distinct LED Modes. Instead of using the Mode Button to cycle through to a desired LED Mode, you can also use the SoundExtreme Smartphone App to find a specific LED Mode.

5. To optimize the LED lighting performance the first time you use the ExtremeController, or you change the LEDs physically connected to a Zone, use the SoundExtreme Smartphone App to select the LED product connected to each Zone. Refer to the **SoundExtreme Smartphone App** instructions for more details.

6. If you have an ECOXGEAR speaker with EcoCast capability and / or a SoundExtreme speaker with LEDCast technology, you can connect the ExtremeController to either product for Music Mode.

If the ExtremeController is unable to pair and connect with the speaker, re-enable the EcoCast pairing on the speaker, then **PRESS AND HOLD** the **ALL** Button on the RF Remote Control to enable EcoCast pairing on the controller. Refer to the **EcoCast for Music Mode** instructions for more details.

7. Short-press the Mode Button to cycle through the multiple Music Modes.

- When no music is playing the LED will be dark. So, please play music while changing Music Modes to review the various Music Mode effects.

- There are 44 distinct LED Modes. Instead of using the Mode Button to cycle through to a desired Music Mode, you can also use the SoundExtreme Smartphone App to find a specific Music Mode.
8. Short-press any of the 8 Color Buttons to change the colors in all LED Zones.





## Advanced Functions

You can also change the LED lighting effect in only 1 Zone at a time:

1. To activate the Zone you want to change, **PRESS AND HOLD** the Zone Button. For example, press and hold the **Z1** Button for 3 seconds. The LEDs in Zone 1 will flash Green twice, indicating that Zone 1 is selected.
2. You can now **PRESS AND HOLD** any of the 8 Color Buttons, the Bright Button, or the Speed Button for 2 seconds (instead of a short-press) to modify the LEDs in the selected Zone.
3. To change another Zone, e.g. Zone 3, **PRESS AND HOLD** the **Z3** Button. The LEDs on Zone 3 will flash Green twice, indicating that Zone 3 is selected. Follow step 2 to modify the LEDs in Zone 3.

**Note:** Anytime you short-press a Common Button on the Remote, it will change the LEDs on all Zones.

# Remote Functions Overview

BUTTON	ACTION	FUNCTION
	<b>Short-Press</b>	Turn on / off the LEDs in all Zones.
	<b>Press and Hold</b> (for 3 seconds)	To enable EcoCast pairing.
	<b>Short-Press</b>	To turn on / off the Zone 1 LEDs.
	<b>Press and Hold</b> (for 3 seconds)	To select Zone 1.
	<b>Short-Press</b>	To turn on / off the Zone 2 LEDs.
	<b>Press and Hold</b> (for 3 seconds)	To select Zone 2.
	<b>Short-Press</b>	To turn on / off the Zone 3 LEDs.
	<b>Press and Hold</b> (for 3 seconds)	To select Zone 3.
	<b>Short-Press</b>	To turn on / off the Zone 4 LEDs.
	<b>Press and Hold</b> (for 3 seconds)	To select Zone 4.



# Remote Functions Overview

---

- When turned on, each of the LEDs will light up Green in ascending order. When turned off, the LEDs light up Red in descending order.
- Does not turn off the ExtremeController. Only the vehicle ignition switch (or rocker switch) can power off the controller.
- Refer to **Zones, Modes, and Scenes. Note:** If you want to turn all of the LED lights off but still want Zones 3 and 4 to function as enhanced brake, reverse, and turn signal lights, use **Street Mode** (Scene 6).

• The  Button on the ExtremeController has the same Action / Function.

- When turned on, LEDs in Zone 1 will light up Green in ascending order. When turned off, the LEDs light up Red in descending order.

• The LEDs in Zone 1 will flash Green twice, indicating that the (Bright, Speed, and Color) Common Buttons will only apply to Zone 1.

- When turned on, LEDs in Zone 2 will light up Green in ascending order. When turned off, the LEDs light up Red in descending order.

• The LEDs in Zone 2 will flash Green twice, indicating that the (Bright, Speed, and Color) Common Buttons will only apply to Zone 2.

- When turned on, LEDs in Zone 3 will light up Green in ascending order. When turned off, the LEDs light up Red in descending order.





• The LEDs in Zone 3 will flash Green twice, indicating that the (Bright, Speed, and Color) Common Buttons will only apply to Zone 3.

- When turned on, LEDs in Zone 4 will light up Green in ascending order. When turned off, the LEDs light up Red in descending order.

• The LEDs in Zone 4 will flash Green twice, indicating that the (Bright, Speed, and Color) Common Buttons will only apply to Zone 4.

# Remote Functions Overview

---

BUTTON	ACTION	FUNCTION
	<b>Short-Press</b>	To cycle through the three LED Mode categories for Zone 1.
	<b>Double-Click</b>	To cycle back to the previous LED Mode for Zone 1.
	<b>Short-Press</b>	To cycle through the three LED Mode categories for Zone 2.
	<b>Double-Click</b>	To cycle back to the previous LED Mode for Zone 2.
	<b>Short-Press</b>	To cycle through the three LED Mode categories for Zone 3.
	<b>Double-Click</b>	To cycle back to the previous LED Mode for Zone 3.
	<b>Short-Press</b>	To cycle through the three LED Mode categories for Zone 4.
	<b>Double-Click</b>	To cycle back to the previous LED Mode for Zone 4.
	<b>Short-Press</b>	To cycle through the three LED Mode categories for all the Zones.
	<b>Double-Click</b>	To cycle back to the previous LED Mode for ALL Zones.
	<b>Press and Hold</b> (for 3 seconds)	To enter Pairing Mode with the ExtremeController.





## NOTES

- There are 44 distinct LED Modes: 8 Color Modes, 18 Party Modes, and 16 Music Modes. You can also use the SoundExtreme Smartphone App to find a specific LED Mode.

- The RF Remote Control comes paired to the ExtremeController. This feature is meant to be used if the connection is lost or a replacement Remote is purchased.

# Remote Functions Overview

---

BUTTON	ACTION	FUNCTION
	<b>Short-Press</b>	To cycle through the 5 defined Scenes for all the Zones.
	<b>Press and Hold</b> (for 3 seconds)	To set all Zones to shine Orange, at 100% brightness and 80% speed.
	<b>Short-Press</b>	To cycle through 5 levels of Brightness for all the Zones.
	<b>Press and Hold</b> (for 2 seconds)	To cycle through 5 levels of Brightness for the selected Zone.
	<b>Short-Press</b>	To cycle through 5 levels of Speed for all the Zones.
	<b>Press and Hold</b> (for 2 seconds)	To cycle through 5 levels of Speed for the selected Zone.
	<b>Short-Press</b>	To select the corresponding Color for all the Zones.
	<b>Press and Hold</b> (for 2 seconds)	To select the corresponding Color for the selected Zone.

## NOTES

- Scene 6 (**Street Mode**) turns all the LED lights off but Zones 3 and 4 will still function as enhanced brake, reverse, and turn signal lights.
- This feature is only available when one of the Zones has been selected via one of the Zone Buttons. (Press and hold Z1, Z2, Z3, or Z4 for 3 seconds).
- This feature is only available when one of the Zones has been selected via one of the Zone Buttons. (Press and hold Z1, Z2, Z3, or Z4 for 3 seconds).
- There are 8 Color Buttons on the Remote Control: Red, Green, Blue, White, Orange, Yellow, Cyan, and Purple. You can also use the SoundExtreme Smartphone App create a custom color.
- This feature is only available when one of the Zones has been selected via one of the Zone Buttons. (Press and hold Z1, Z2, Z3, or Z4 for 3 seconds).

# SoundExtreme App

---

The ExtremeController can be operated via the SoundExtreme Smartphone App.

## Download and Install

For iPhones, download the app from the following URL:

**<https://apps.apple.com/us/app/soundextreme/id1670708941>**

For Android phones, download the app from the following URL:

**<https://play.google.com/store/apps/details?id=com.cchip.ecoxgear>**

Alternatively, use the following QR Codes to download the SoundExtreme Smartphone App.



iOS



Android

## App Overview

**Password Secured:** The app is password protected so others cannot gain access and control your ExtremeController. The default password is 0000.

**Name Your Devices:** You can change and customize the name of your devices and Zones, such as Rear speakers, Soundbar, Subwoofer, Cabin Lights, Underglows, Roof Lights, Whips, etc.

**Set Up Modes:** Use the app to set up the LED Mode for each of the 4 Zones on your ExtremeController. You can also change the Brightness and Speed.

**Create and save Scenes:** A Scene is a preprogrammed light show that you can save for later quick-access. We have created 5 default Scenes that are fully customizable and programmable.

**Set Up a Group:** Create and set up a group of devices (multiple ExtremeControllers, or other SoundExtreme products with LEDCast built-in). This will allow all the LED lights connected to different devices to be controlled by the SoundExtreme Smartphone App at the same time.

**Bluetooth Low Energy:** The SoundExtreme Smartphone App relies on a BLE (Bluetooth Low Energy) connection between your phone and the ExtremeController. Make sure you turn on Bluetooth on your smartphone.

## Initial App Connection and Device & LED Setup

1. Launch the SoundExtreme App on your smartphone or other BLE-enabled device.
2. On the SoundExtreme App homepage, tap **Refresh List**.



# SoundExtreme App

---

3. If your ExtremeController is powered on, it will show up as **4 Zone Controller** on the app's **Connect Device** screen. Tap the device name on the screen. A checkmark will appear on the right. Tap the **Connect** button.
4. A dialog window will popup asking you to enter a password. The ExtremeController default password is 0000.
5. If the app connects to your ExtremeController successfully, a popup message will appear, showing the Device & LED Settings for the 4 Zones on your controller and ask you if you want to change the settings. On the bottom of the message there is a checkbox to ask if you want this message to be displayed the next time the app connects to your controller.
6. If you choose to change the Device & LED Settings, the app will bring you to the Device & LED Set Up menu for you to choose the LED device from the pull-down list.

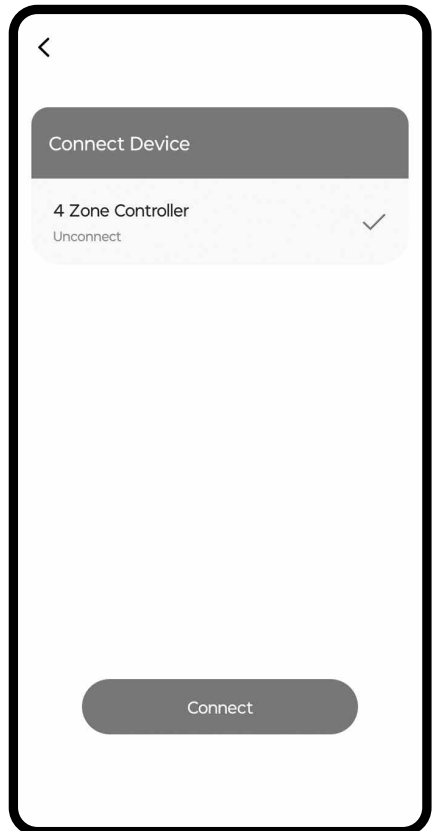



- Once the Device & LED Settings are completed, the app will bring you to the **Device** screen.
- Select your controller. It will take you to the Scene Screen. There are 6 predefined Scenes on the controller. You can turn on one of first 5 Scenes to light up the LEDs. For example, click the On / Off button at the right for Scene 1, the Speaker LEDs will light up Orange, which is the LED lighting mode defined for Scene 1.

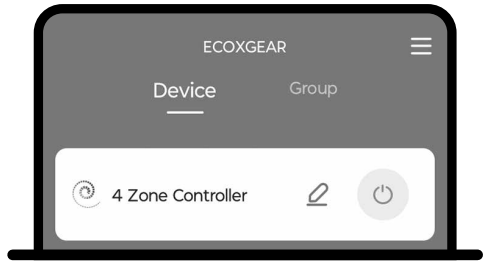

# SoundExtreme App

## Set Up Zones

1. Select your ExtremeController on the Device list, and the app will bring you to the **Zone** screen.
2. Tap one of the 4 Zones, and you will go to the Zone LED Mode Settings screen. There are 3 tabs: Color, Party, and Music, which allow you to select a solid Color, a Party Mode, or a Music Mode.

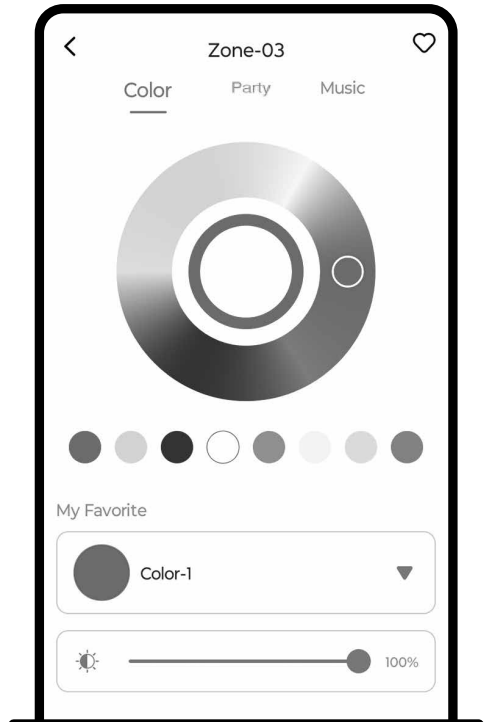

- When you choose a Mode, the LEDs connected to the Zone you selected will light up accordingly, giving you a preview.
- If you tap the **Save** button on the screen, the app will save your setting for the selected Zone.
- If you tap the **Cancel** button or exit the LED Mode Settings screen, your Mode selection will not be saved and LEDs connected to that Zone will display the previously selected LED Mode.

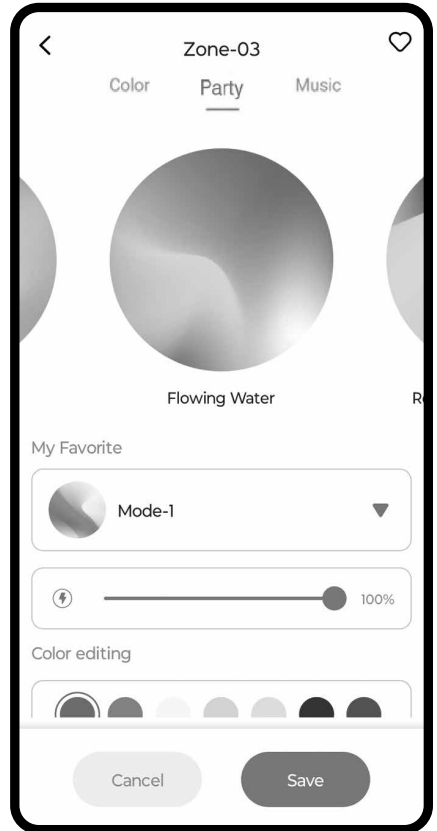

# SoundExtreme App

---

3. After you set up the Modes for each of the Zones, the controller setup is complete.

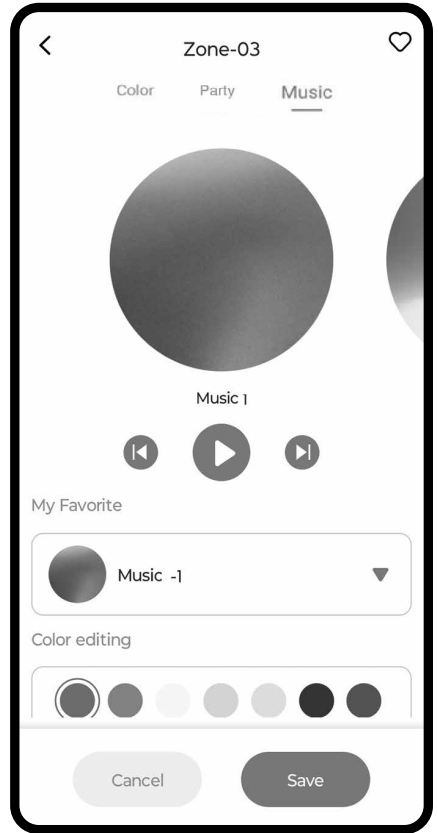

## Set Up Scenes

1. Select your ExtremeController on the Device list, and the app will bring you to the **Zone** screen. Tap the **Scene** tab. The app will show 6 pre-defined scenes on your controller. As previously mentioned in **Zones, Modes, and Scenes**, Scene 6 is designed for Street Mode and not editable. Street Mode turns all the lights off but keeps the controller on. If you have the controller connected to your vehicle's turn signals, brakes and / or reverse wires, the connected LED devices in Zones 3 and 4 will still light up when applicable.
2. You can change a Scene's LED settings by selecting any of the first 5 Scenes. When you select the Scene you will go to the LED Mode Setting screen. You can use the same procedure as in the **Set Up Zones** section to set up each Zone and save the Scene's new LED settings.





# SoundExtreme App

3. After you set up LED Modes for all the Zones, the setup is complete for the selected Scene.

## Change Password

To add extra security, you can change the default password of 0000 to your desired 4-digit numeric password. Please note that the password is stored in your ExtremeController, not the SoundExtreme app. So, after you change the password, please make a note in case you forget your password. The password won't be reset by reinstalling the app or changing to another smartphone. The only way to reset your password is to conduct a factory reset on your ExtremeController.

1. Select the Menu Icon  at the top-right corner of the screen.
2. Select  **Device Password** from the menu.
3. Once at the Device Password screen, select the device that you want to change the password to.

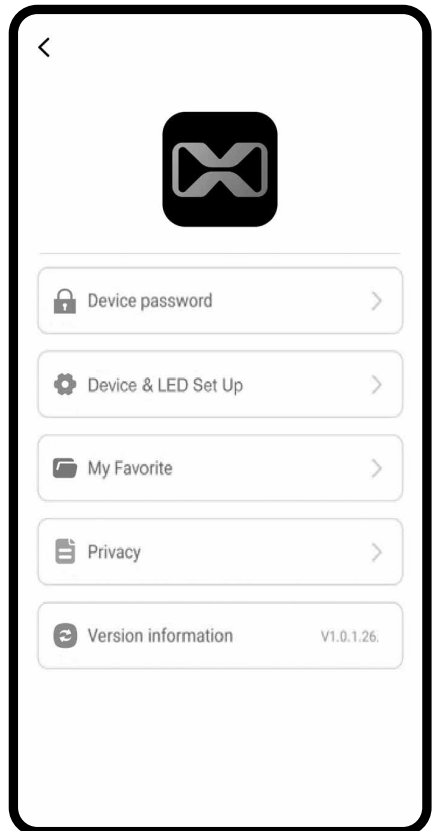
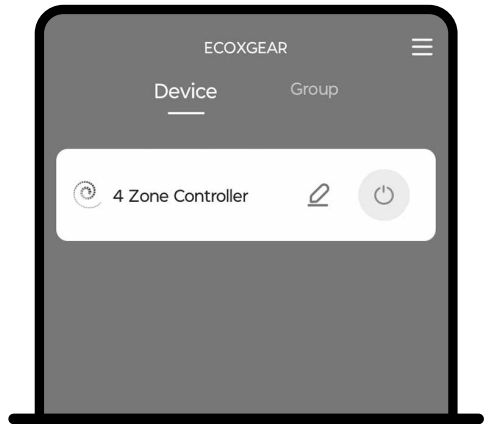

4. Enter the current password, the new password, and re-enter the new password. Then tap the **Confirm** button.
5. If the change is successfully saved, the app will display a confirmation message.

This is a one-time event. You do not have to enter in your password every time you launch the app, as your app will remember your password.

The screenshot shows the 'Device password' screen in the SoundExtreme app. At the top left is a back arrow, and the title 'Device password' is centered. Below the title are four input fields, each with a label on the left and a placeholder on the right. The first field is labeled 'Device' and contains the text '4 Zone Controller' followed by a right-pointing chevron. The second field is labeled 'Original password' and has 'Original password' as a placeholder. The third field is labeled 'New password' and has 'New password' as a placeholder. The fourth field is also labeled 'New password' and has 'New password' as a placeholder. At the bottom of the screen is a large, rounded, grey button with the text 'Confirm' centered on it.

## Factory Reset

If you forget the password, you will need to do a Factory Reset on the ExtremeController so that the password is reset to its default value: 0000.

- Turn off the power to the ExtremeController by turning off the ignition switch (or the rocker switch), then turn it back on.
- While the Status LED Indicator flashes Blue, **PRESS AND HOLD** the  Button for 3 seconds. The indicator will flash Yellow to show that the reset is successful.

**Note:** Besides the password reset, a Factory Reset will also configure the ExtremeController to the following factory settings:

- The LED Device Type is set to 6' ExtremeWhip for all 4 Zones.
- The LED Mode is set to solid Orange Color with 100% Brightness and the Speed is set to 80%, for all the 4 Zones.
- All 5 customer configurable Scenes are set to the Factory Default Scenes.



## Dimensions

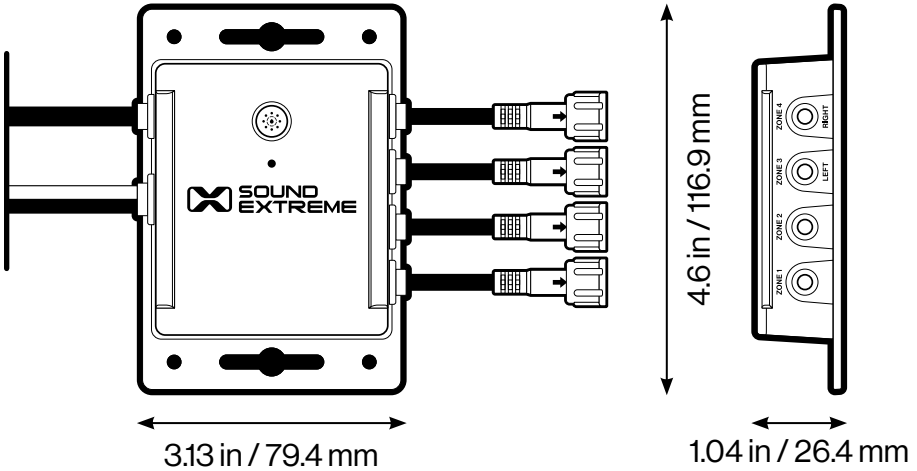

### Unit Weight

0.44 lbs (0.2 kg)

### Power Input

12V, 20A

### Remote Turn-on Input

12V – 56V

### Vehicle Signal (Left, Right, Brake, Reverse) Input:

12V

### Blade Fuse

25A, 32V

### Bluetooth Frequency Band

2.402~2.480GHz ISM Spectrum

### Bluetooth Compliance

Bluetooth® 5.1

### EcoCast Range

30 ft / 9.1 m between Casting speaker and ExtremeController

### LED Control Output on Each Zone

5A

### Storage Temperature

-40°F to 122°F / -40°C to 50°C

### Operating Temperature

23°F to 95°F / -5°C to 35°C

# Important Legal Information

---

## FCC STATEMENT:

This device complies with Part 15 of the FCC Rules. Operation is subject to the following two conditions:

- 1.) This device may not cause harmful interference, and
- 2.) This device must accept any interference received, including interference that may cause undesired operation.

**WARNING:** Changes or modifications not expressly approved by the party responsible for compliance could void the user's authority to operate the equipment.

**NOTE:** FCC's RF Exposure guidelines, this equipment should be installed and operated with minimum distance between 20cm the radiator to your body.

This equipment has been tested and found to comply with the limits for a Class B digital device, pursuant to Part 15 of the FCC Rules. These limits are designed to provide reasonable protection against harmful interference in a residential installation. This equipment generates, uses, and can radiate radio frequency energy and, if not installed and used in accordance with the instructions, may cause harmful interference to radio communications. However, there is no guarantee that interference will not occur in a particular installation. If this equipment does cause harmful interference to radio or television reception, which can be determined by turning the equipment off and on, the user is encouraged to try to correct the interference by one or more of the following measures: reorient or relocate the receiving antenna, increase the separation between the equipment and receiver, connect the equipment into an outlet on a circuit different from that to which the receiver is connected, consult the dealer or an experienced radio/TV technician for help.

## RF WARNING STATEMENT:

The device has been evaluated to meet general RF exposure requirement. The device can be used in portable exposure condition without restriction.

## IC STATEMENT:

This device complies with Industry Canada licence-exempt RSS standard(s). Operation is subject to the following two conditions:

- 1.) This device may not cause interference, and
- 2.) This device must accept any interference, including interference that may cause undesired operation of the device.

## PRODUCT USE AND PROTECTION:

**Read and follow all instructions. Use only as intended.**

The SoundExtreme unit is intended to be used indoors or outdoors and in land or water environments. The unit has been tested to IP66 waterproofing standards, which means the unit can be exposed to dust and water, but should **NOT** be submerged underwater.

To prevent fire or shock, do **NOT** attempt to power this unit if it is wet or you suspect water has entered the unit. In this situation, please return the unit to SoundExtreme for a free assessment. If we have found that the unit has carried water, we will repair or replace the unit free of charge.

## SAFETY ADVISORY & WARNING:

**Read and follow all instructions. Use only as intended.**

**CAUTION:** Do **NOT** open to repair. A qualified technician must carry out repair work.

**ATTENTION:** Do **NOT** connect to a SoundExtreme product with LEDCast technology while the unit is wet. Make sure all connections are dry **BEFORE** connecting to a power source. Failure to do so may result in electrical damage to the unit and may void the warranty.

 **WARNING:** Cancer and Reproductive Harm - [www.P65Warnings.ca.gov](http://www.P65Warnings.ca.gov)

**ATTENTION:** Do **NOT** dispose of in a landfill. Contact SoundExtreme at [www.gracesupport.com](http://www.gracesupport.com) or a certified recycling agent to dispose of the unit.

## SAFETY:

This product has a limited life span of use and should be replaced when it shows obvious signs of wear.

Do not modify or remove any original component parts of the speaker. Doing so could cause damage to the unit, allowing water to ingress. A unit with water ingress should not be charged due to potential risk of fire or shock.

Please exercise care and good judgment when using your SoundExtreme unit.

**You should always**

- 1.) Return the unit to SoundExtreme if you suspect water ingress into the unit or if the unit has experienced a severe impact that may have affected the integrity of the unit to take on water.

# Important Legal Information

---

## You should never

- 1.) Never power your SoundExtreme unit if you suspect water has entered the device. Powering a device with water inside could be potentially hazardous and cause fire or a spark.
- 2.) Never use your SoundExtreme unit if you have dropped it or thrown it against a hard surface which may have destroyed the integrity of the housing. In the event of a severe impact to your unit, please return the unit to SoundExtreme to review for potential damage.
- 3.) Never attempt to fix, repair your SoundExtreme unit. Please send it back to SoundExtreme for any assessments and repairs.

## CARE, MAINTENANCE & PRECAUTIONS:

- 1.) Do **NOT** apply excessive force to any surfaces of the unit.
- 2.) Do **NOT** use or store the unit in places with high temperature.
- 3.) **AVOID** prolonged exposure to ultraviolet radiation (UV sunlight) and strong magnetic fields.

## LIMITED MANUFACTURER'S WARRANTY:

The ExtremeController is covered by a 1-year limited warranty that covers defects in workmanship and / or materials for a period of 1 year from original purchase date. This warranty does not apply to any products which have been abused, neglected, modified or used for a purpose other than the one for which they were manufactured. Please refer to the above care and maintenance instructions for suggested care details. The warranty is valid only for the original owner who purchases the unit from an authorized dealer. Transfers do not qualify for warranty protection. SoundExtreme reserves the right to replace any out-of-stock or discontinued product with a comparable product. Discontinued products may not be available for warranty replacement. Any contents are **NOT** covered by the limited manufacturer's warranty. Warranty terms may be revised without notification at the discretion of the manufacturer. Please visit [www.soundextreme.us](http://www.soundextreme.us) for additional product & warranty information.



ExtremeController by SoundExtreme Inc., Houston, Texas.  
Designed in Texas. Made in China.

## What's in the Box

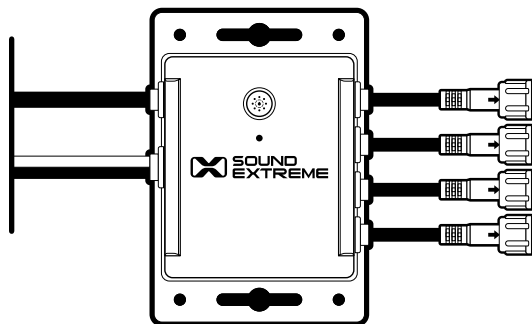

ExtremeController

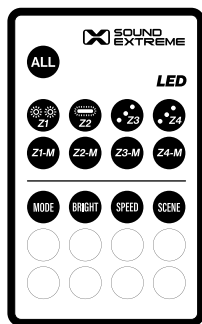

RF Remote Control

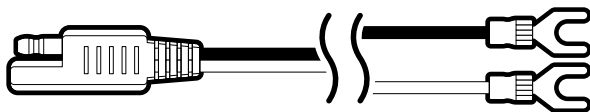

SAE Power Cable – 8 ft long

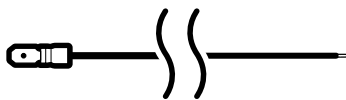

Remote Turn-On Extension Cable (Dark Blue) – 10 ft long