

BC

# 1 DIN Marine Radio

Model: SEI-SEMRN1DIN



## User Guide

# Introduction

---

- Please read this User Guide and the Installation Guide before installation and use.

## Features

The 1 DIN Marine Radio (referred to as Radio) includes the following features.

**Daylight viewable 2.3” LCD display** with brightness and contrast adjustment.

### Multi Audio Source Inputs

- Bluetooth streaming.
  - Bluetooth 5.1 long range and reliable connection to your phone.
  - Dual simultaneous connections - switch playback between two phones.
- FM and AM radio.
- Aux-In.

### Multi-Audio Zone Outputs

- 2 wired zones and 1 wireless (EcoCast) zone
- 2 Zone (4 channel) speaker outputs: 25 W X 4 RMS, 50 W x 4 max @ 4 Ohms
- 2 Zone pre-amplified RCA outputs
- 1 subwoofer pre-amplified RCA output
- Amp-On signal output to turn on /off external audio amplifier.

### Wired Audio Zone Output Controls

- 3 Band EQ: BASS/MID/TREBLE.
- Left and Right Channel balance adjustment.

- Volume limit settings.
- Subwoofer filter and level adjustment.

## **Audio Volume Adjustments**

- 3 Zone volume control.
- 1 Subwoofer volume control.

## **Built-in EcoCast Wireless Audio**

- Wirelessly stream your radio's Bluetooth music, AM/FM radio and AUX in audio to EcoCast enabled ECOXGEAR and SoundExtreme soundbars, subwoofers, radios, and party speakers.
- Play audio streams wirelessly received from an EcoCast transmitting speaker. No wires!

## **Built-in Speakerphone Function**

- Enable or disable speakerphone function
- Choice of your favorite ringtones
- Ringtone volume setting

## **4 LED Zone Lighting Control Outputs**

- No need to buy a separate LED controller to drive your speaker's LEDs.
- Control additional LEDCast-enabled LED strips and WHIPS.

## **RF Universal Remote Control**

- Control the core audio and lighting functions remotely anywhere near and around your vehicle.

## **Smartphone SoundExtreme App**

- With the Free smartphone SoundExtreme App customize your LED's colors, speed, brightness, music sync, and LED chasing. Create custom Scenes to change all Zones at once with your

# Introduction

---

favorite LED light show. Add additional 4-Zone LED controllers (sold separately) and other LEDCast Products to expand your light show. Group all your LEDCast Products together and control them all from 1 app.

## Important

- The Radio requires +12V DC voltage for the power input. If your vehicle battery power is not 12V (e.g., 24V, 36V, or 48V), you will need a DC-DC voltage converter with 12V output (e.g. a 48V-to-12V converter). Connecting the Radio directly to higher voltages will cause damage to the Radio and **VOID THE PRODUCT WARRANTY**.
- The Radio's power supply is controlled by your boat or land vehicle's ignition switch, or a rocker switch. So, with the combined operation of the switch and the Power Button on the Radio, the Radio may be in the On or Standby Powered State after you turn on your switch, as described in the Installation Guide. So, if the Radio is not turned on after you turn on your switch, press the Power Button to turn it on.
- The Radio has an embedded microphone on the front panel for smartphone speakerphone calls. The Speakerphone Function is **DISABLED** as the factory default. If you want to use the Speakerphone Function, you will need to enable it in the Radio's Menu **BEFORE** you pair your phone to the Radio. Enabling or disabling the Speakerphone Function will erase the Bluetooth pairing records on your radio. So, if you pair your phone with the Radio first, then enable the Speakerphone Function, the Radio will lose the pairing records with your phone. In this case, you will have to go to your phone's Bluetooth setting menu to forget the Radio, then pair your phone with the Radio, once again. Refer to **Phone Connection and Speakerphone Function – Speakerphone** for more details.

# 1 DIN Marine Radio Overview

## 1 DIN Marine Radio Front Panel Layout

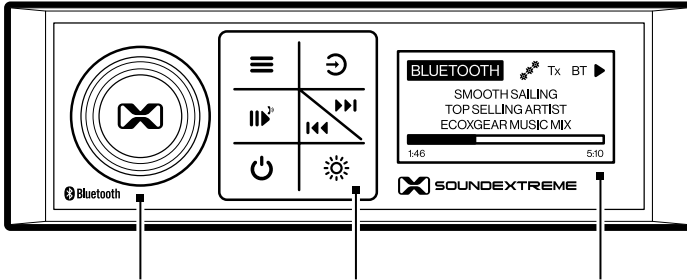



Volume and Select Dial

Control Buttons

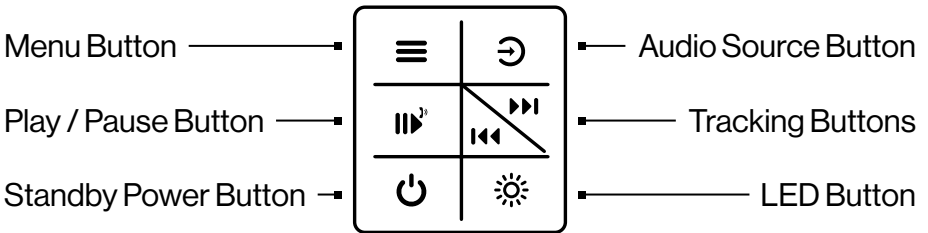

LED Screen





# 1 DIN Marine Radio Overview

BUTTON	ACTION	FUNCTION
 (Dial)	<b>Turn</b>	<ul style="list-style-type: none"><li>· On a <b>Now Playing</b> or the <b>Volume Control</b> screen, change volume.</li><li>· On a <b>Menu</b> screen, navigate to highlight a menu item.</li></ul>
	<b>Short-Press</b>	<ul style="list-style-type: none"><li>· On a <b>Now Playing</b> screen, bring up <b>Zone Volume Control</b> screen.</li><li>· On a <b>Menu</b> screen, press to select, deselect, or confirm.</li></ul>
	<b>Press and Hold</b> (for 3 seconds)	<ul style="list-style-type: none"><li>· On a <b>Now Playing</b> screen, bring up the <b>Subwoofer Volume Change</b> screen.</li></ul>
	<b>Short-Press</b>	<ul style="list-style-type: none"><li>· On a <b>Now Playing</b> screen, go to the audio source's related menu.</li><li>· On a <b>Menu</b> screen, go back to the previous menu.</li></ul>
	<b>Press and Hold</b> (for 3 seconds)	<ul style="list-style-type: none"><li>· Go to device <b>Settings</b> menu.</li></ul>

# 1 DIN Marine Radio Overview

BUTTON	ACTION	FUNCTION
	<b>Short-Press</b>	<ul style="list-style-type: none"><li>Go to <b>Audio Source Selection</b> menu for Bluetooth, FM, AM, Aux-In, and EcoCast Receiving .</li></ul>
	<b>Press and Hold</b> (for 3 seconds)	<ul style="list-style-type: none"><li>Go to <b>Audio Settings</b> menu.</li></ul>
	<b>Short-Press</b>	<ul style="list-style-type: none"><li>On the <b>Bluetooth Now Playing</b> screen, play or pause music.</li><li>In any Mode, when connected with phone and speakerphone is enabled, accept an incoming call. Short-press again to hang up.</li><li>On the <b>FM/AM Now Playing</b> screen, change the Radio's Tuning Mode: Auto, Manual, or Preset.</li></ul>
	<b>Press and Hold</b> (for 3 seconds)	<ul style="list-style-type: none"><li>In Bluetooth Mode and if speakerphone is enabled, initiate EcoTalk or reject an incoming call.</li><li>On <b>FM/AM Now Playing</b> screen, save current station to a Preset.</li></ul>

# 1 DIN Marine Radio Overview

BUTTON	ACTION	FUNCTION
	Short-Press	<ul style="list-style-type: none"><li>· On the <b>Bluetooth Now Playing</b> screen, while playing audio, skip to the previous track.</li><li>· On the <b>FM/AM Now Playing</b> screen, tune to the previous frequency.</li><li>· On the <b>Aux-In Now Playing</b> screen, decrease input gain (dB).</li></ul>
	Short-Press	<ul style="list-style-type: none"><li>· On the <b>Bluetooth Now Playing</b> screen, while playing audio, skip to the next track.</li><li>· On the <b>FM/AM Now Playing</b> screen, tune to the next frequency.</li><li>· On the <b>Aux-In Now Playing</b> screen, increase input gain (dB).</li></ul>
	Short-Press	<ul style="list-style-type: none"><li>· Mute.</li></ul>
	Press and Hold (for 3 seconds)	<ul style="list-style-type: none"><li>· Turn on the Radio or go to Standby.</li></ul>
	Short-Press	<ul style="list-style-type: none"><li>· Go to <b>LED Settings</b> menu.</li></ul>
	Press and Hold (for 3 seconds)	<ul style="list-style-type: none"><li>· Turn on / off LED's in all Zones.</li></ul>
	Double-Click	<ul style="list-style-type: none"><li>· Go to the <b>LED Zone Status</b> screen.</li></ul>



## Now Playing Screen Overview

When an audio source has been connected / selected, the Radio's default screen is the Now Playing screen.

The following actions will bring up various menus:

- Press or turn the Dial to access the Volume Level screen. Press the Dial to highlight the Zone you want to change, then turn the Dial to change the volume in that Zone. The next time you access the Volume Screen, the Radio will remember the Zone you previously selected.

Depending on your music source and EcoCast status, you may or may not see the Master Volume Bar.

- Press the Menu Button to access the Settings Menu.

Turn the Dial to highlight and press to select a menu item.

- Press the Audio Source Button to access the Audio Source Menu.

Turn the Dial to highlight and press to select a menu item to change the settings.

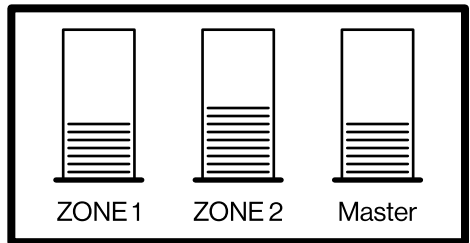

# Radio Screen and Menu

---

## Bluetooth Now Playing Screen

When the Audio Source is Bluetooth, the Now Playing screen will show the following status.

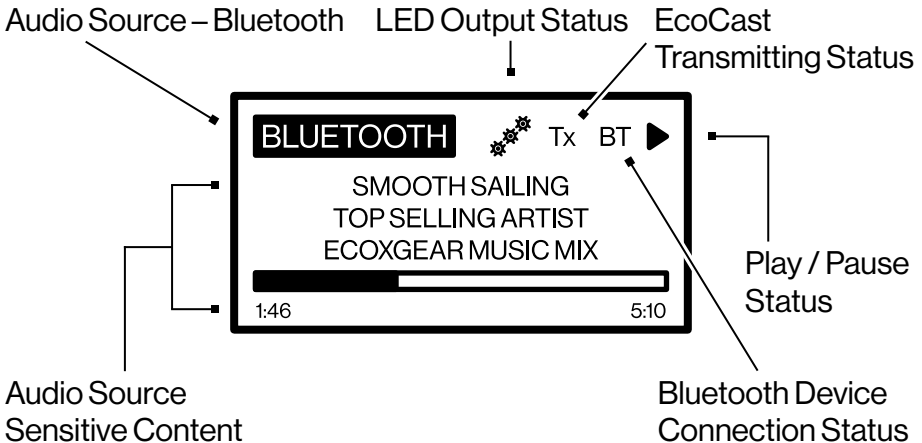

The Bluetooth Icon **BT** indicates 3 connection statuses:

- Solid **BT** Icon – The Radio is connected to a Bluetooth device (e.g. a phone).
- Flash **BT** Icon – The Radio is in Bluetooth pairing mode waiting for a phone to pair and connect.
- No **BT** Icon – The Radio has not connected to a phone and is not in pairing mode.

If there is no **BT** Icon on the screen, you can press the Menu Button

to bring up **BLUETOOTH** Menu, then select **BT SETTINGS** Menu to enable Bluetooth pairing by selecting **Discoverable**. The **BT** Icon will flash on the screen, indicating that the Radio is waiting for your phone to pair and connect.

Once the Radio connects to your phone, you can play music and press the Play/Pause, Next Track, or Previous Track Buttons for playback control. You can adjust Audio Volume with the Dial, and

# Radio Screen and Menu

change settings by pressing the Menu or Audio Source Button.

Depending on your audio metadata and the player on your phone, the Audio Source Metadata will show track details, elapsed time, etc.

If there is no phone connected to the Radio, the Now Playing Screen will show a message, “Press Menu button to connect to a phone.” When you press the Menu Button, it will bring up the **BLUETOOTH** Settings Screen.

Select BT SETTINGS, then select Discoverable. It will enable Bluetooth pairing. You can go to your phone’s Bluetooth setting screen and find “**SoundEx-radio**” to connect. Once connected, you can play audio.

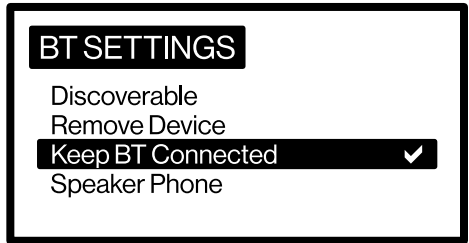
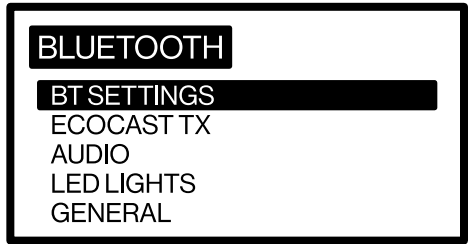

## FM and AM Radio Now Playing Screens

When the audio source is FM or AM radio, the Radio screen will show the following status.

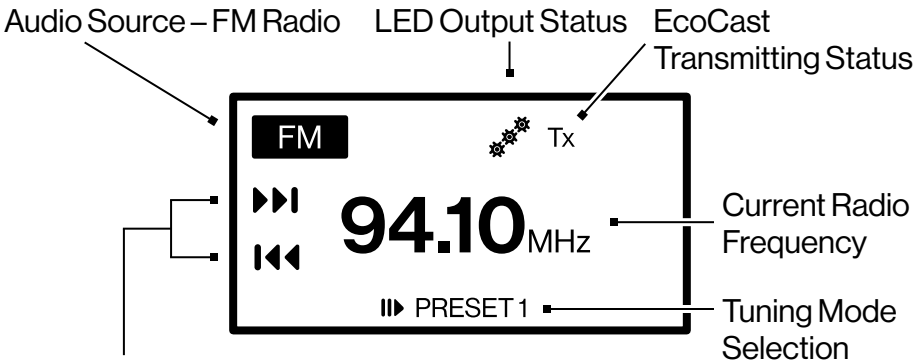

Recommended Buttons: Tune to Next / Previous Station

# Radio Screen and Menu

---

The 3 playback control icons on the FM or AM Now Playing Screen serve as a reminder of their corresponding buttons:

1. Play / Pause Icon – Select **⏮** to change the Radio's Tuning Mode:
  - Auto – The Radio will automatically tune to stations.
  - Manual – The Radio will tune a station per user button presses.
  - Preset – The Radio will play a saved Preset.
2. Next Track / Previous Track Icons – Seek forward **⏭** or backward **⏪** in the Radio's station tuner.

When on the FM (or AM) Now Playing screen, press the Menu Button to bring up the Setting screen. Then, select the FM Presets Menu for the option of saving the current FM station to a Preset, remove a Preset or select a Preset to play.

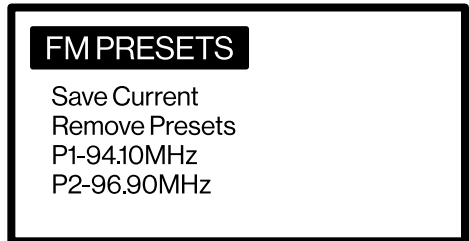

## Aux-In Audio Now Playing Screen

When the audio source is Aux-In Audio, the Radio screen will show the following status.

# Radio Screen and Menu

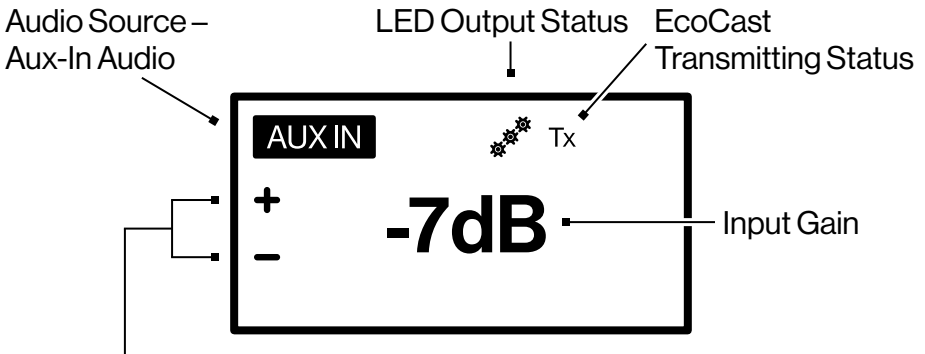

Recommended Buttons:  
Increase / Decrease Input Gain

The Aux-In Now Playing screen has 2 Recommended Button Icons:

- **+** Icon/ **-** Icon – Indicates that you can increase or decrease the input gain of the external audio source connected to the Radio by pressing the **▶▶** and **◀◀** Buttons on the Radio.

Press the Menu Button to bring up the Aux-In settings.



## EcoCast Transmitting and Receiving

### EcoCast

The Radio has EcoCast built-in, which allows it to broadcast (transmit) or receive audio streams to or from other EcoCast-enabled products. SoundExtreme by ECOXGEAR has a complete line of EcoCast-enabled speakers, soundbars, subwoofers, and radios.

# Radio Screen and Menu

---

EcoCast streaming works in two modes:

1. EcoCast Transmitting Mode – When set in this Mode, the Radio's audio playback (music played from FM or AM radio, your phone via Bluetooth, or Aux-In Audio) will broadcast to multiple wirelessly connected EcoCast Speakers.
2. EcoCast Receiving Mode – When set in this Mode, the Radio will receive streaming audio from an EcoCast Transmitting speaker.

Like the Bluetooth pairing and connection between a Bluetooth device and a phone, there is an EcoCast pairing and connection between the EcoCast Transmitting and EcoCast Receiving devices. Once paired, the EcoCast Receiving device will save the EcoCast Transmitting device into its pairing records and will automatically reconnect to the EcoCast Transmitting device.

A **Tx** Icon will be displayed on the top of the Now playing screen when the Radio is in ECOCAST TX Mode and an **Rx** Icon when in EcoCast Receiving Mode.

EcoCast Tx Icon status:

- Solid **Tx** Icon – The Radio is in EcoCast Transmitting Mode.
- Flashing **Tx** Icon – The Radio is in the process of EcoCast Pairing, waiting for an EcoCast Receiving speaker or radio with which to pair and connect.

EcoCast Rx Icon status:

- Solid **Rx** Icon – The Radio is connected to an EcoCast Transmitting speaker or radio.
- Flash **Rx** Icon – The Radio is in broadcast Rx Pairing Mode, waiting for an EcoCast Transmitting speaker or radio with which to pair and connect.

By default, the Radio's EcoCast feature is enabled. You can disable or re-enable it by pressing the Menu Button to bring the audio related setting menu. For example, if you are on the Bluetooth Now Playing

# Radio Screen and Menu

Screen, press the Menu Button to bring up the Settings Menu. Select **ECOCAST TX**, then select or deselect EcoCast Enabled menu item to enable or disable your Radio's EcoCast feature.

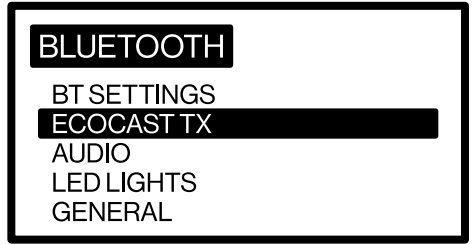

If EcoCast is enabled, after you select Bluetooth, or FM/AM, or Aux-In audio as audio input, the Radio will enable EcoCast pairing for 3 minutes. The **Tx** Icon will flash on the Radio's Screen. If you see a solid **Tx** Icon and want to enable EcoCast pairing for a new EcoCast Receiving device, you can press the Menu Button, select **ECOCAST TX**, then **EcoCast Pairing**.

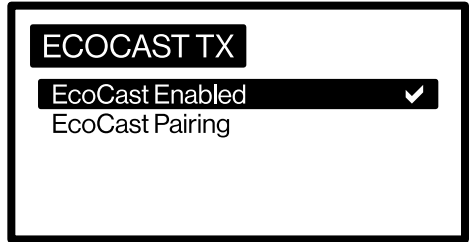

## EcoCast Receiving Now Playing Screen

When the audio source is EcoCast Receiving, EcoCast is automatically enabled. The Radio Screen will show the following status.

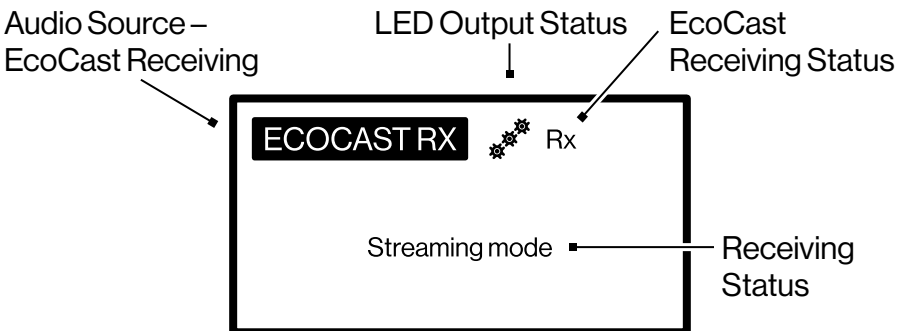

# Radio Screen and Menu

---

Once the Radio pairs and connects to an EcoCast Transmitting speaker, the Radio will play the receiving streaming audio automatically.

## **Streaming Your Bluetooth Audio, FM/AM Radio or AUX-In Audio to Multiple Speakers**

When EcoCast is enabled and the Radio is playing audio (Bluetooth audio, FM/AM radio station, or Aux-In audio), it will automatically stream the audio to other wirelessly connected EcoCast speakers or radios in EcoCast Receiving Mode.

If you have a new EcoCast Receiving speaker to pair with the Radio, you can press the Menu Button, select **ECOCAST TX**, then **EcoCast Pairing**.



# Radio Audio Output Volume Control

## Zone 1, 2, and 3 Volume Control Screen

The Radio has 3 Zone Audio Outputs: 2 wired and 1 wireless. When EcoCast is not enabled, there is no wireless audio output. Accordingly, there are only 2 Zone Volume Controls.

The Radio has a Zone Volume screen for you to change the audio volume for each Zone or all the Zones. Depending on if EcoCast is enabled or disabled, the Zone Volume Screen may have 3 or 2 vertical bars for you to adjust the Zone Volume.

On the Zone Volume Screen, you can press the Dial to highlight a specific Zone or both Zone 1 and 2, then turn the Dial to change the Zone volume(s).

When Zone 1 and 2 are both highlighted, a + symbol will be shown between the Zone 1 and Zone 2 volume bars. So, both Zone 1 and 2 will have the same incremental changes when you turn the Dial.

The Radio saves the highlighted volume Zone status into its memory as the Highlighted Zone

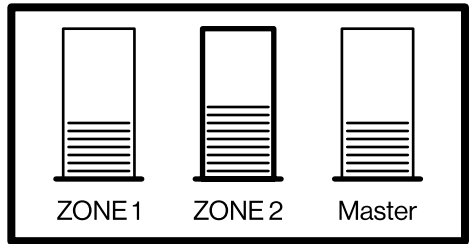

3 Zone Volume Control  
(EcoCast Enabled)

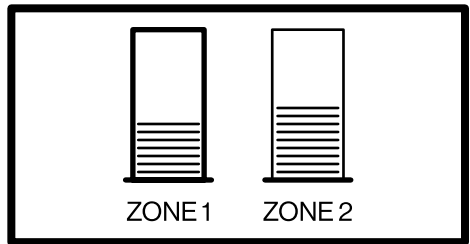

2 Zone Volume Control  
(EcoCast Disabled or in  
EcoCast Receiving Mode)

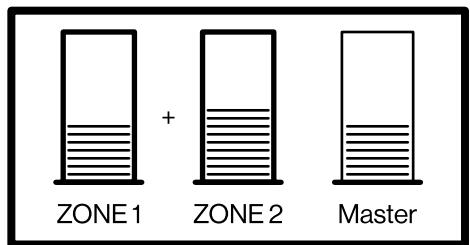

Both Zone 1 and Zone 2  
are Selected

# Radio Audio Output Volume Control

---

Volume, to easily change the volume of the previously accessed Zone(s).

The third Zone (Master) volume adjustment changes the Bluetooth volume on the Radio's Bluetooth module. Therefore, in some cases, it acts as a Master Volume, which impacts Zone 1 and Zone 2 audio output volume.

The table below lists the relationship between Master Volume, Bluetooth Volume and Phone Volume.

<b>AUDIO SOURCE</b>	<b>MASTER VOLUME VS PHONE VOLUME</b>	<b>BLUETOOTH VOL VS PHONE VOL</b>
<b>Bluetooth</b>	<b>Master Vol = Phone Vol</b>	<b>Bluetooth Vol = Phone Vol</b> (Bluetooth and Phone volumes are synced)
<b>FM/AM/Aux In</b>	<b>Master Vol = Bluetooth Vol</b>	<b>Bluetooth Vol ≠ Phone Vol</b> (Bluetooth and Phone volumes are not synced)

The following are the Radio's 3 Zone audio output volumes against Zone 1, 2, and Master Volume adjustments on the Zone Volume screen.

# Radio Audio Output Volume Control

## Audio Source: Bluetooth

AUDIO ZONE	AUDIO OUTPUT VOLUME
Zone 1	= Master Volume setting x Zone 1 Vol setting
Zone 2	= Master Volume setting x Zone 2 Vol setting
EcoCast	= Master Volume setting

## Audio Source: FM or AM Radio

AUDIO ZONE	ECOCAST	AUDIO OUTPUT VOLUME
Zone 1	Enabled	= Master Volume setting x Zone 1 Volume setting
	Disabled	= Zone 1 Volume setting
Zone 2	Enabled	= Master Volume setting x Zone 2 Volume setting
	Disabled	= Zone 2 Volume setting
EcoCast	Enabled	= Master Volume setting
	Disabled	N/A

# Radio Audio Output Volume Control

## Audio Source: Aux-In Audio

AUDIO ZONE	ECOCAST	AUDIO OUTPUT VOLUME
Zone 1	Enabled	= Master Volume setting x Zone 1 Volume setting x Input gain ( $\pm 9$ dB range)
	Disabled	= Zone 1 Volume setting x Input gain ( $\pm 9$ dB range)
Zone 2	Enabled	= Master Volume setting x Zone 2 Volume setting x Input gain ( $\pm 9$ dB range)
	Disabled	= Zone 2 Volume setting x Input gain ( $\pm 9$ dB range)
EcoCast	Enabled	= Master Volume setting
	Disabled	N/A

## Audio Source: EcoCast Receiving

AUDIO ZONE	AUDIO OUTPUT VOLUME
Zone 1	= Zone 1 Volume setting x Audio Stream Volume*
Zone 2	= Zone 2 Volume setting x Audio Stream Volume*

\*The Audio Stream Volume is the volume the EcoCast Receiving Radio receives from the EcoCast Transmitting speaker or radio.

# Radio Audio Output Volume Control

---

**NOTE:** A product in EcoCast Receiving Mode will play at the same volume level (volume sync) as received in the audio streams from the EcoCast Transmitting product. You can adjust Zone 1 or Zone 2 on the Zone Volume screen to adjust the volume for the Zone 1 or Zone 2 Audio Output Volume only. However, as soon as the EcoCast Transmitting product has a playback change (e.g. track change, or a volume change), the Radio's incoming Audio Streaming Volume will have a volume sync with the Transmitting product.

## Subwoofer Volume Control

You can adjust the subwoofer output volume level by pressing and holding the Dial for 3 seconds to bring up the Sub Level Screen. Then, change the level by turning the Dial.

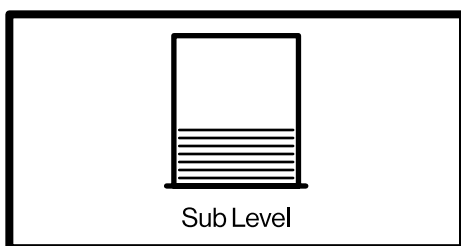

The subwoofer volume level is independent from Zone 1 or Zone 2 volume. However, the Master Volume setting has an impact on the subwoofer volume output.

# Radio Audio Output Volume Control

The following table lists the subwoofer volume output under different audio sources.

<b>AUDIO ZONE</b>	<b>ECOCAST</b>	<b>SUBWOOFER VOLUME OUTPUT LEVEL</b>
Bluetooth	N/A	= Master Vol setting x Sub Level setting
FM or AM Radio	Enabled	= Master Vol setting x Sub Level setting
	Disabled	= Sub Level setting
Aux-In	Enabled	= Master Vol setting x Sub Level setting x Input gain ( $\pm 9$ dB range)
	Disabled	= Sub Level setting x Input gain ( $\pm 9$ dB range)
EcoCast Receiving		= Sub Level setting x Audio Stream Volume*

\*The Audio Stream Volume is the volume the EcoCast Receiving Radio receives from the EcoCast Transmitting speaker or radio.

# Radio Audio Output Control

The Radio's built-in EQ and Amplifier have the following features to set two Audio Zone configurations independently.

To bring up the Audio Zone Configuration Menu, you can press the Menu Button when the Radio is on the Now Playing Screen for any audio source (Bluetooth, FM, AM, Aux-In, or EcoCast RX).

Once you select **AUDIO**, it will take you to the Audio Settings Screen. As Zone 3 EcoCast is for wireless, there is no EQ setting.

There is only one subwoofer output, the subwoofer audio settings are under the Zone 1 Audio Settings Menu.

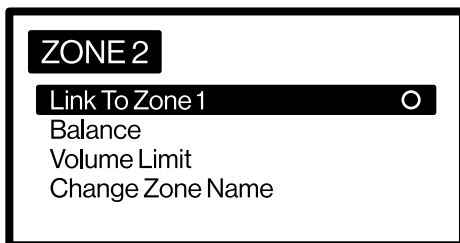
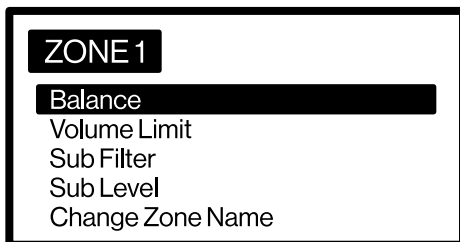

# Radio Audio Output Control

## Equalizer

The Radio has a 3 band EQ: Bass, Mid, and Treble. Press the Dial to highlight **BASS**, **MID**, or **TREBLE** Bar, then turn the Dial to change the settings.

**NOTE:** The EQ settings are for both Zone 1 and 2. It does not apply to Zone 3 EcoCast.

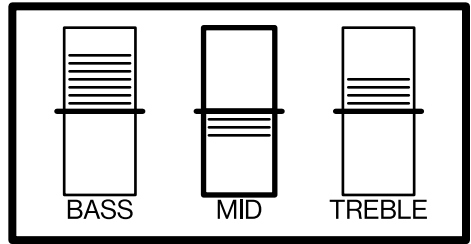

3 Band EQ: Bass, Mid, and Treble

## Balance

Zone 1 and Zone 2 have independent Balance Settings Screens.

## Volume Limiter

Zone 1 and Zone 2 each has a Volume Limiter Setting Screen, where you can adjust the maximum volume for each Zone's output.

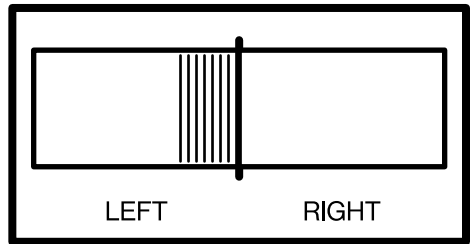

Balance Settings

## Subwoofer Settings

There are two settings for the subwoofer output:

1. Sub Filter – There are 5 sub filter settings: Pass, 55Hz, 85Hz, 120Hz, or 160Hz. The selected frequency is the subwoofer cutoff frequency. The Radio will only send the subwoofer output signals below the selected cutoff frequency.

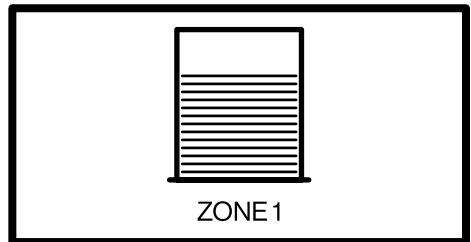

Volume Limiter



2. Sub Level – When you select this menu, it will bring up the Sub Level screen for you to adjust the subwoofer output level.

## **Change Zone Name**

The default names for audio Zone 1 and 2 are **Zone 1** and **Zone 2**. You can change the name by editing the name or select a predefined name on the Radio.

## **Linked Zone**

If you want to set Zone 2 volume level to follow Zone 1 volume level, select **Link to Zone 1**.

Once linked, a + symbol will be shown between the Zone 1 and Zone 2 volume bars on the Zone Volume Screen, and the volume settings will be synchronized.

# Speakerphone Functions

## Speakerphone

The Radio has an embedded microphone on the front panel to use for speakerphone calls.

The feature comes disabled by default. If you want to use the Speakerphone function, you will need to enable it **BEFORE** you pair your phone to the Radio. Enabling or disabling the Speakerphone feature will erase the Bluetooth pairing records on your Radio. So, if you pair your phone with the Radio first, then enable the Speakerphone function, the Radio will lose the pairing records with your phone. In this case, you will have to go to your phone's Bluetooth setting menu to forget the Radio, then pair your phone with the Radio again.

To enable the Speakerphone function, select Bluetooth as the Audio Source. On the Now Playing Screen, press the Menu Button to bring up the Bluetooth Settings Screen. Then, select **BT SETTINGS**, select **Speaker Phone**, select **Enable**.

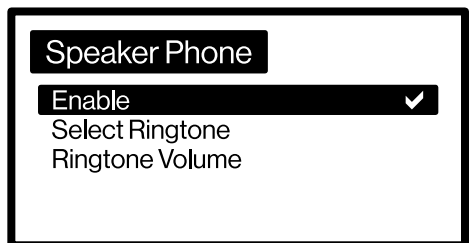
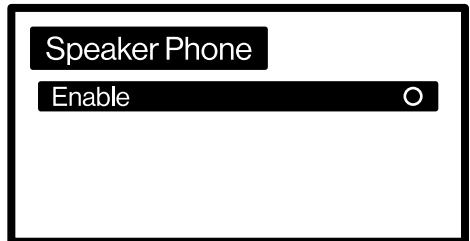
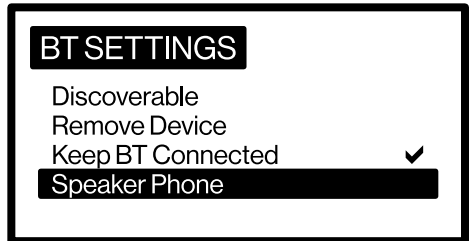
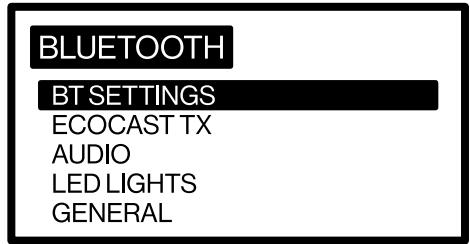

# Speakerphone Functions

Once the Speakerphone feature is enabled, the Radio will show **Select Ringtone** and **Ringtone Volume** settings menu options, where you can select a ringtone from the 15 predefined ringtones on the Radio and set the ringtone volume. When you select a ringtone or set a volume, the Radio will play the ringtone once at the volume you set up so that you can check your ringtone settings. We provide the option to adjust your ringtone volume level so the ringtone can be set lower than your music volume setting.

As your speakers are connected to your Radio's Zone 1 or Zone 2 outputs, so are the ringtone's sound outputs determined by the Zone 1 or Zone 2 volume settings. Below are ringtone sounds output volumes for Zone 1 and 2.

## Ringtone Sound Outputs

AUDIO ZONE	RINGTONE SOUND OUTPUT VOLUME
Zone 1	= Ringtone Volume setting x Zone 1 Vol setting
Zone 2	= Ringtone Volume setting x Zone 2 Vol setting

## Phone Connection in FM, AM, Aux-In or EcoCast Receiving Mode

When the Audio Source is in FM, AM, Aux-In, or EcoCast Receiving Mode, the Radio will disconnect your phone.

However, if you want to have Speakerphone function when the Audio Source is not Bluetooth, you will need to enable the Keep Phone Connected feature. When the Audio Source is Bluetooth, on the Now Playing Screen, press the Menu Button to bring up the Bluetooth Settings Screen. Select **BT SETTINGS**, then select **Keep Phone Connected**.

# Speakerphone Functions

---

Once **Keep Phone Connected** is enabled, your phone's ringer will play from the Radio's connected speakers and the microphone will activate, regardless of the Radio's current Audio Source. For example, when the Radio is playing an FM station, if your phone receives a call, the Radio will display **Incoming Call** on the screen and the speakers connected to Zone 1 and 2 will produce the ringtone you selected.

# Radio General Settings

The Radio's General Menu has the following functions:

1. Display Settings – Change display's brightness and contrast.
  2. Keypad Backlight – Turns the Keypad and Dial's backlight on or off.
  3. Power Save – When Power Save is enabled, the Radio will automatically turn off the keypad backlight 30 seconds after no keypad activity.
  4. Low Battery Warning –The radio checks the voltage level of the battery that it is connected to and notifies you when your battery voltage / charge is low. When the Low Battery Warning feature is enabled, and the Radio detects that the input voltage is below the Low Battery Level setting (default is 10.8VDC), it will display the message “Low Battery Warning”.
- To modify this setting go to **GENERAL > Low Battery Warning > Low Battery Level** to set your desired low voltage value (between 9V and 12V).
5. Tuner Region – The radio supports 4 FM/AM Tuner Regions: USA, Europe, Japan, and Australasia. The default setting is USA.
  6. Remote Setup – Allows you to pair or remove remote controls. Refer to **Remote Control Pairing** for details about pairing a new remote.
  7. Factory Reset – Clears all customer settings and memory. The Radio will bring up a message asking you to press the Play/Pause Button to confirm the Factory Reset.



Please note that a Factory Reset will clear 100% of your custom settings and Radio's memory and return it to the factory default.

# Radio LED Lighting Output Control

---

The Radio has a built-in 4-Zone LED light controller. The LED lights driven by the integrated controller provide millions of colors: solid colors, fading, jumping, chasing, speed, and variable brightness.

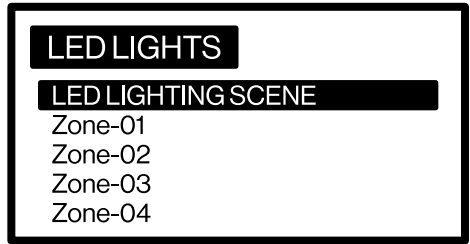

Press the LED Button to bring up the **LED LIGHTS** Menu Screen, then go to specific functions.

## LED Lighting Zones, Mode, and Scenes

- **Zone** – A Zone corresponds to all of the LED lights that are connected directly to one physical LED Control Output on the Radio. When you change a Zone status (On/ Off, Mode, etc.), the LEDs connected to that Zone will change accordingly. You can control one Zone or multiple Zones at a time.

**NOTE:** While it is not required, typically the LED's in the wired speakers connected to Zone 1 would be connected to the Radio's built-in LED controller's Zone 1 and the speakers connected to Zone 2 would have their LED's connected to the LED controller's Zone 2.

- **Mode** – There are 3 LED Lighting Mode categories, totaling in 44 Modes supported by the RF Remote. The SoundExtreme App can support many more Color Modes.
  1. **Color Mode:** Each Color Mode lights up the LEDs in a solid color. There are 8 Color Buttons on the Remote Control: Red, Green, Blue, White, Orange, Yellow, Cyan, and Purple. You can create a custom color by utilizing the SoundExtreme Smartphone App.
  2. **Party Mode:** There are 20 preset Party Modes accessible via the Radio Menu, the Remote Control, and the SoundExtreme Smartphone App. The app allows you to customize each of the

# Radio LED Lighting Output Control

---

20 Party Modes, allowing for nearly unlimited color, cascading, and LED chasing options.

3. Music Mode: There are 16 Music Modes accessible via the Radio Menu, the Remote Control, and the SoundExtreme Smartphone App.

- **Scene** – A Scene is programmed via the SoundExtreme Smartphone App. You can customize each Zone into a Scene (a preset). Setting the Scenes on the app allows a 1-button press to bring up your desired custom settings for all of the LED products connected to the Radio.

The Radio supports 6 lighting Scenes. Scenes 1-5 are user customizable and programmable. The 6th scene, Street Mode, is for special use and cannot be modified. The default Scene settings are:

- Scene 1: Patriot 1 for all 4 Zones (Red, White, and Blue).
- Scene 2: Flowing colors for all 4 Zones.
- Scene 3: Zoom for all 4 Zones.
- Scene 4: Fading colors for all 4 Zones.
- Scene 5: Christmas for all 4 Zones (Red, Green, and White).
- Scene 6: Street Mode – Turns all LED lights off but keeps the built-in controller powered on so Zones 3 and 4 will still function as enhanced brake, reverse, and turn signal lights.

## Street Mode: Zone 3 and 4 Vehicle Signaling

If you have integrated the Radio with the Vehicle's Signal Inputs as described in the Installation Guide, you can use the Street Mode function.

Under normal operations, when all 4 Zones are turned off, the vehicle signaling in Zones 3 and 4 automatically enters Off Mode.

# Radio LED Lighting Output Control

---

When LEDs in any of the 4 Zones are turned on, as soon as the controller has a vehicle's signal input, Zone 3 and 4 LEDs will light up accordingly. The LEDs will resume their original status (an LED Mode) once the vehicle signal input is gone.

You can also use the RF Remote Control to turn the LED lights in all 4 Zones on or off (when the controller has a vehicle's Remote Turn-On Signal Input). Simply **Press and Hold** the Power Button to turn the LEDs in all 4 Zones on or off. When the LEDs in all 4 Zones are turned off, the Radio's LED lighting controller has the following two functions:

- **Off Mode:** When the LEDs in all 4 Zones are turned off, the controller disables the vehicle signaling to the LEDs in Zones 3 and 4, i.e. Zone 3 and 4 LEDs will not light up, even if there is a vehicle signal input. This Off Mode is for users who do not want their LEDs to light up while they are driving.
- **Street Mode:** When the controller is in this Mode, all 4 Zone LEDs are also turned off. However, as soon as the controller has a vehicle's signal input, the LEDs in Zone 3 and 4 will light up accordingly. The LEDs will turn off once the vehicle signal input is gone.

To enable Street Mode, press the LED Button to bring up the LED Lights Menu, select the **LED LIGHTING SCENE**, then select **Scene 6 – Street Mode**. When the Radio enters Street Mode, each of the LEDs in all 4 Zones will briefly light up Blue in ascending order to indicate that Street Mode is active.

When the Radio is in Street Mode, any Mode change to a Zone (e.g. change Zone 1 Color) or Scene change will bring the controller out of Street Mode and into the selected setting. When the Radio exits Street Mode, each of the LEDs in all 4 Zones will briefly light up Blue in descending order.



## LED Lighting Menu

You can bring up the LED Lights Menu by pressing the LED Button.

The LED Lights Menu has the following functions.

### 1. LED LIGHTING SCENE:

Select one of the 6 pre-defined scenes either by factory default settings or by the SoundExtreme App.

### 2. LED ZONE 1, 2, 3, and 4:

Go to each Zone to select the LED lighting effects. You can do the following for a specific Zone.

- Turn the LED on/off.
- Select one of the 8 predefined Colors or the 5 My Favorite Colors which are set by the SoundExtreme App.
- Select one of the 20 predefined Party Modes or the 5 My Favorite Party Modes which are set by the SoundExtreme App.
- Select one of the 16 predefined Music Modes or the 5 My

### LED LIGHTS

#### LED LIGHTING SCENE

Zone-01  
Zone-02  
Zone-03  
Zone-04

#### LED LIGHTING SCENE

Scene-1  
Scene-2  
Scene-3  
Scene-4  
Scene-5

#### Zone-01

Turn On  
Color  
Party  
Music  
Brightness

#### Color

My Favorite  
Red  
Green  
Blue  
White

# Radio LED Lighting Output Control

---

Favorite Music Modes which are set by the SoundExtreme App.

- Change the speed of a Party Mode or Music Mode.
- Change the LED brightness.
- Copy the current Zone LED settings to one specific Zone or all the Zones.

**Party**

- My Favorite
- Fading colors
- Jumping colors
- Rainbow
- Flowing colors

**Music**

- My Favorite
- Music mode 1
- Music mode 2
- Music mode 3
- Music mode 4

3. **LED STATUS:** Brings up the LED Zone Status Screen showing LED On or Off status for all the 4 Zones.

4. **DEVICE & LED SETTINGS:** The Radio's integrated LED lighting controller can support multiple types of SoundExtreme LED products. All 4 Zones come preset to the 6 foot ExtremeWhip. To optimize the LED light performance, the first time you use the Radio, or you make LED Zone connection changes after the initial set up, you should use the SoundExtreme App to choose the specific LEDCast product that is connected to each Zone.

**NOTE:** Each LEDCast enabled product has a different number of LED's. Hence selecting the product that you have connected to each Zone will optimize the effect.

## Turn All LED Zones On or Off

**PRESS AND HOLD** the LED Button for 3 seconds to turn on/off all LED zones.

To check the LED Zone status, double-click the LED Button.

# SoundExtreme Universal Remote Control

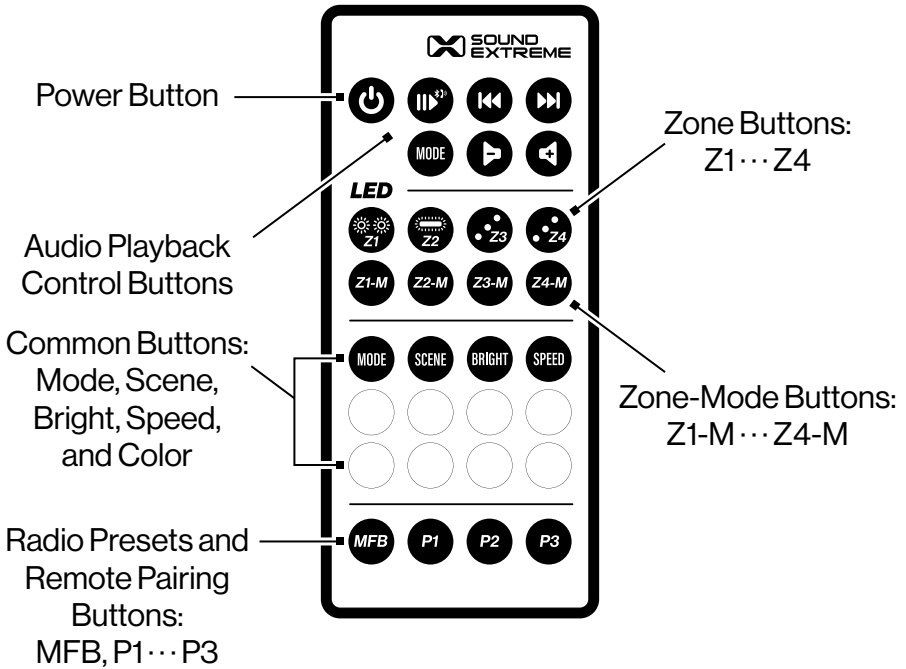





The Radio comes with a SoundExtreme Universal Remote Control.

## Remote Button Layout and Functions

### 1. Power Button

- Short-press to turn on the Radio or put the Radio into Standby.
- Press and hold for 3 seconds to turn on or off all the LED Zones.

### 2. Mode Button (right below the Play/Pause Button)

- Short-press to bring up the Audio Source Menu or return to the Now Playing Screen.
- On the Audio Source Screen, press the  or  Button to highlight the next menu item, press the  or  Button to highlight the previous menu item, press the Play/Pause Button  to select the highlighted menu item.

# SoundExtreme Universal Remote Control

---

## 3. Play/Pause , Next Track , and Previous Track Buttons

- Short-press to play/pause, or change the soundtrack playback respectively.

## 4. Volume and Buttons

- On the Now Playing Screen, short-press to adjust the volume for the Highlighted Zone Volume saved on the Radio.

## 5. LED Lighting Effect Control Buttons

- Z1, Z2, Z3, and Z4 Buttons – Turn on/off each individual LED Zone.
  - When an LED Zone is turned on, the LEDs will light up Green in ascending order, then light up in a random color pattern or in which Scene the system was in before it was turned off.
  - When an LED Zone is turned off, the LEDs will light up Red in descending order, then turn off.
- Z1-M, Z2-M, Z3-M, and Z4-M Buttons – Cycle through all the LED Modes for LEDs in the corresponding Zone.
- Mode, Bright, Speed, and Scene Buttons – Adjust all 4 Zones.
  - Short-press the Mode Button to cycle through the 44 LED Lighting Modes.
  - Short-press the Bright or Speed Buttons to cycle through the 5 levels of LED Lighting brightness or speed.
  - Short press the Scene Button to cycle from Scene 1 through Scene 5.

## 6. MFB, P1, P2, and P3 Buttons

- When the Radio is playing FM or AM radio, P1, P2, and P3 act as Preset Buttons.
  - Short-press P1, P2, or P3 Button, the Radio will tune to the saved station corresponding to that Preset Button.

# SoundExtreme Universal Remote Control

---

- Press and hold P1, P2, or P3 Button for 2 seconds to save the current station to the corresponding Preset.
- A combined use of the MFB Button with P1, P2, or P3 will let you pair your Remote with up to 3 Radios, ExtremeTower speakers, or soundbars, or to select a device to control. Refer to the following for more details.

## Remote Control Pairing

The SoundExtreme Universal Remote Control can pair and save up to 3 Marine Radios, or ExtremeTower Amplified Speakers in its memory as P1, P2, and P3 radios or speakers. The included Remote Control is already paired with your Radio as the P1 speaker.

If the Radio somehow does not react when you press a button, check if the battery isolator (clear plastic tab) on the Remote battery compartment is removed (pulled out). Then, refer to the following steps:

1. On the Radio, press the Menu Button, go to GENERAL > Remote Setup and select **Add Remote**.
2. On your Remote, press and hold the MFB Button for 3 seconds, then press P1 (P2 or P3) to save the pairing speaker as P1 (P2 or P3) speaker. When the pairing is successful, the Radio screen will show a new remote with a check mark.

## Select a Device to Control

If you want to use the Remote to also control another device (e.g. an ExtremeTower speaker), follow the steps below.

1. **PRESS AND HOLD** the MFB Button for 3 seconds. P1 will indicate your Remote is in the process of device selection as follows:
  - All 4 Zone LEDs will flash Blue.
  - The Radio will display the message **Remote Transfer Started**.

# SoundExtreme Universal Remote Control

---

2. While P1 is flashing Blue, press P2. P2 device will flash Blue and produce a prompt double-beep tone, indicating P2 is selected.
3. Press a button on the Remote. P2 device will produce the corresponding action, while P1 device will have no response.

If you want the Remote go back to control P1, follow the steps below.

1. **PRESS AND HOLD** the MFB Button for 3 seconds, P2's Party Lights will flash Blue, indicating your Remote is in the process of device selection.
2. While P2 is flashing Blue, press P1. The Radio screen will display **Radio and Remote Reconnected**, indicating P1 is selected.
3. Press a button on the Remote. The Radio will produce the corresponding action, while P2 device will have no response.

## Advanced Functions

### Go to Previous Mode

As indicated previously, you can cycle through all the LED Modes in all four Zones by pressing the LED Mode Button or cycle through individual Zones by pressing the Z1-M, Z2-M, Z3-M, or Z4-M Buttons.

If you want to go back to the previous Mode, you can do the following:

1. Double-click the Mode Button to cycle back to the previous LED Mode for all four Zones.
2. Double-click the Z1-M, Z2-M, Z3-M, or Z4-M Button to cycle back to the previous LED Mode for the corresponding Zone.

### Change Color for a Specific Zone

A short-press of any of the 8 Color Buttons will change the colors in all LED Zones.

You can also change the LED Lighting Effect in only 1 Zone at a time in the following manner:





# SoundExtreme Universal Remote Control

---

1. To activate the Zone you want to change, **PRESS AND HOLD** the corresponding Zone Button. For example, **PRESS AND HOLD** the Z1 button for 3 seconds. The LEDs in Zone 1 will rapidly flash Green twice, indicating Zone 1 is selected.
2. You can now **PRESS AND HOLD** for 2 seconds (instead of short-pressing) any of the 8 Color Buttons, the Bright Button, and the Speed Button. Only the LEDs in Zone 1 will change.
3. To change another Zone, e.g. Zone 3, **PRESS AND HOLD** the Z3 Button. The LEDs in Zone 3 will rapidly flash Green twice, indicating Zone 3 is selected. You can now **PRESS AND HOLD** a Common Button for 2 seconds to change the LEDs in Zone 3.

**NOTE:** Anytime you short-press a Common Button on the Remote, it will change the LED on all four Zones.

# Remote Functions Overview







BUTTON	ACTION	FUNCTION
	<b>Press and Hold</b> (for 3 seconds)	Turn on / off the LEDs in all Zones.
	<b>Short-Press</b>	Turn on / put the Radio into Standby Mode.
	<b>Short-Press</b>	<ul style="list-style-type: none"> <li>On the <b>Bluetooth Now Playing</b> screen, play or pause music.</li> <li>In any Mode, when connected with phone and speakerphone is enabled, accept an incoming call. Short-press again to hang up.</li> <li>On the <b>FM/AM Now Playing</b> screen, change the Radio's Tuning Mode: Auto, Manual, or Preset.</li> </ul>
	<b>Press and Hold</b> (for 3 seconds)	<ul style="list-style-type: none"> <li>In Bluetooth Mode and if speakerphone is enabled, initiate EcoTalk or reject an incoming call.</li> <li>On <b>FM/AM Now Playing</b> screen, save current station to a Preset.</li> </ul>
	<b>Short-Press</b>	<ul style="list-style-type: none"> <li>On the <b>Bluetooth Now Playing</b> screen, skip to the previous or the next track.</li> <li>On the <b>FM/AM Now Playing</b> screen, tune in a station.</li> </ul>
	<b>Short-Press</b>	To increase or decrease the volume for the Highlighted Zone Volume.



## NOTES

- When turned on, each of the LEDs will light up Green in ascending order. When turned off, the LEDs light up Red in descending order.
- When in Standby Mode, the speaker consumes minimal power.







# Remote Functions Overview

BUTTON	ACTION	FUNCTION
 (Audio)	Short-Press	To bring up the <b>Audio Source</b> menu or return to the <b>Now Playing</b> screen.
	Press and Hold (for 3 seconds)	Go to <b>Audio Settings</b> menu.
 	Short-Press	To turn on / off each Zone.
	Press and Hold (for 3 seconds)	To select a single Zone.
 	Short-Press	To cycle through the three LED Mode categories for the selected Zone.
	Double-Click	To cycle back to the previous LED Mode for the selected Zone.
 (LED)	Short-Press	To cycle through the three LED Mode categories for all Zones.
	Double-Click	To cycle back to the previous LED Mode for all Zones.
	Short-Press	To cycle through the 5 defined Scenes for all Zones.
	Press and Hold (for 3 seconds)	Set all Zones to Patriot 1, 100% Brightness, and 80% Speed.

## NOTES

- When turned on, LEDs in all Zones will light up Green in ascending order. When turned off, the LEDs light up Red in descending order.
- The LEDs in the selected Zone will rapidly flash Green twice. You can now **Press and Hold** one of the Common Buttons to change the Brightness, Speed, or Color for the selected Zone.
- There are 44 distinct LED Modes: 8 Color Modes, 20 Party Modes, and 16 Music Modes. You can also use the SoundExtreme Smartphone App to find a specific LED Mode.
- There are 44 distinct LED Modes: 8 Color Modes, 20 Party Modes, and 16 Music Modes. You can also use the SoundExtreme Smartphone App to find a specific LED Mode.
- You must first **Press and Hold** the corresponding Zone Button to select a Zone before using this feature.

# Remote Functions Overview

BUTTON	ACTION	FUNCTION
	<b>Short-Press</b>	To cycle through 5 levels of Brightness / Speed for all Zones.
	<b>Press and Hold</b> (for 2 seconds)	To cycle through 5 levels of Brightness / Speed for the selected Zone.
	<b>Short-Press</b>	To select the corresponding Color for all Zones.
	<b>Press and Hold</b> (for 2 seconds)	To select the corresponding Color for the selected Zone.
	<b>Press and Hold</b> (for 3 seconds)	To select a speaker to control.
	<b>Press and Hold</b> (for 2 seconds)	When in FM Mode: To save the current station to the P1 Button.
	<b>Short-Press</b>	When in FM Mode: To tune to the station saved to the P1 Button
	<b>Press and Hold</b> (for 2 seconds)	When in FM Mode: To save the current station to the P2 Button.
	<b>Short-Press</b>	When in FM Mode: To tune to the station saved to the P2 Button
	<b>Press and Hold</b> (for 2 seconds)	When in FM Mode: To save the current station to the P3 Button.
	<b>Short-Press</b>	When in FM Mode: To tune to the station saved to the P3 Button

## NOTES

- There are 8 Color Buttons on the Remote Control: Red, Green, Blue, White, Orange, Yellow, Cyan, and Purple. You can also use the SoundExtreme Smartphone App create a custom color.
- You must first **Press and Hold** the corresponding Zone Button to select a Zone before using this feature.
- Refer to **Remote Button Layout and Functions**, **Remote Control Pairing**, and **Select a Device to Control** for more details.
- Refer to **Remote Button Layout and Functions**, **Remote Control Pairing**, and **Select a Device to Control** for more details.
- Refer to **Remote Button Layout and Functions**, **Remote Control Pairing**, and **Select a Device to Control** for more details.
- Refer to **Remote Button Layout and Functions**, **Remote Control Pairing**, and **Select a Device to Control** for more details.

# SoundExtreme App

---

The built-in controller can be operated via the SoundExtreme Smartphone App.

## Download and Install

For iPhones, download the app from the following URL:

**<https://apps.apple.com/us/app/soundextreme/id1670708941>**

For Android phones, download the app from the following URL:

**<https://play.google.com/store/apps/details?id=com.cchip.ecoxgear>**

Alternatively, use the following QR Codes to download the SoundExtreme Smartphone App.



iOS



Android

## App Overview

**Password Secured:** The app is password protected so others cannot gain access and control your Radio. The default password is 0000.

**Name Your Devices:** You can change and customize the name of your devices and Zones, such as Rear Speakers, Soundbar, Subwoofer, Cabin Lights, Underglows, Roof Lights, Whips, etc.

**Set Up Modes:** Use the app to set up the LED Mode for each of the 4 Zones on your Radio. You can also change the Brightness and Speed.

**Create and Save Scenes:** A Scene is a preprogrammed light show that you can save for later quick-access. We have created 5 default Scenes that are fully customizable and programmable.

**Set Up a Group:** Create and set up a group of devices (multiple Radios, ExtremeControllers, or other SoundExtreme products with LEDCast built-in). This will allow all the LED lights connected to different devices to be controlled by the SoundExtreme Smartphone App at the same time.

**Bluetooth Low Energy:** The SoundExtreme Smartphone App relies on a BLE (Bluetooth Low Energy) connection between your phone and the Radio. Make sure you turn on Bluetooth on your smartphone.

## Initial App Connection and Device & LED Setup

1. Launch the SoundExtreme App on your smartphone or other BLE-enabled device.
2. On the SoundExtreme App homepage, tap **Device Connection List**.
3. If your Radio is powered on, it will show up as **LEDs-radio** on the app's **Connect Device** screen. Tap the device name on the screen. A checkmark will appear on the right. Tap the **Connect** button.
4. A dialog window will popup asking you to enter a password. The Radio's default password is 0000.
5. If the app connects to your



# SoundExtreme App

---

Radio successfully, a popup message will appear, showing the Device & LED Settings for the 4 Zones on your Radio and ask you if you want to change the settings. On the bottom of the message there is a checkbox to ask if you want this message to be displayed the next time the app connects to your Radio.

6. If you choose to change the Device & LED Settings, the app will bring you to the Device & LED Set Up menu for you to set up the LED device type in each Zone.
7. For the Device Field, select your Radio (**LEDs-radio**) from the pull-down list.

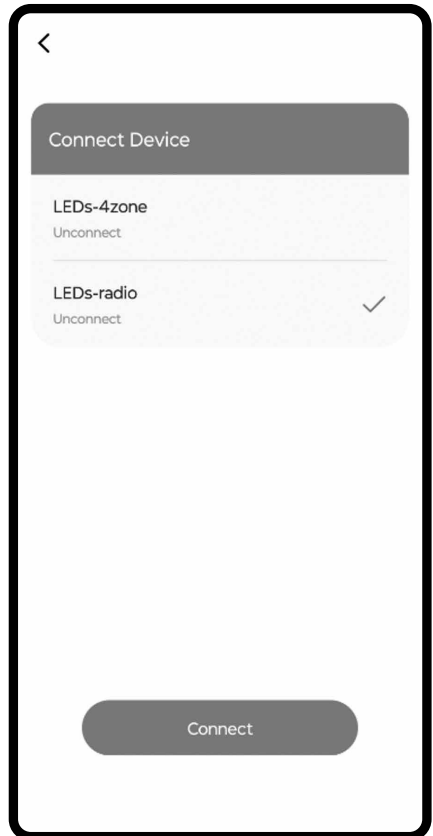
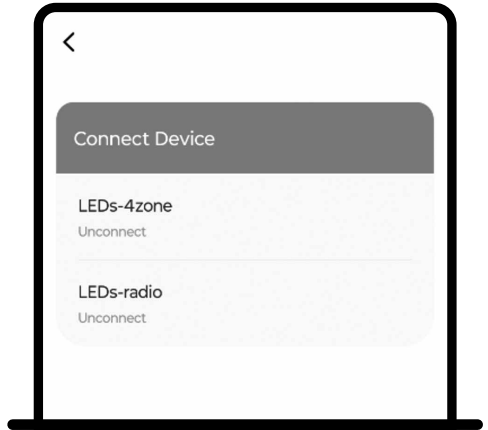



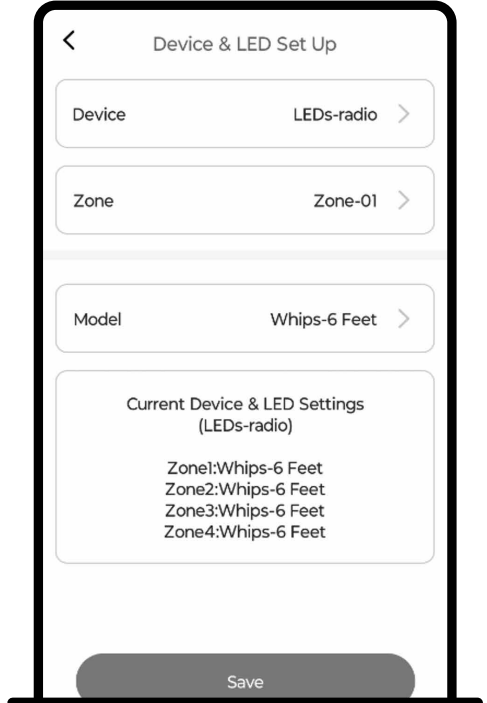
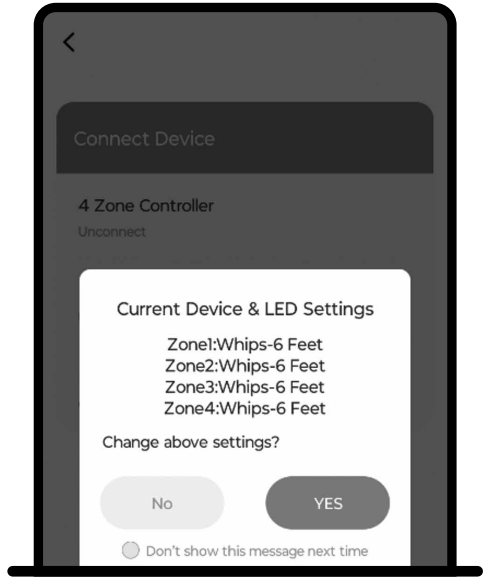

8. For the Zone Field, select the Zone (Zone 1, 2, 3, or 4) your LEDCast-enabled product is connected to.

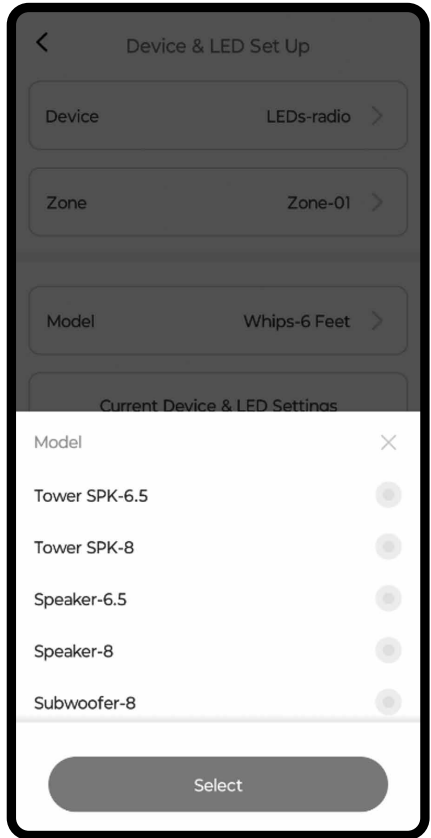

# SoundExtreme App

- For the Model Field, select the LEDCast-enabled product (in the Zone you selected above) from the pull-down list.
- Once the Device & LED Settings are completed, the App will bring you to the **Device** List screen.



11. Select your Radio. It will take you to the **Scene** screen. There are 6 predefined Scenes on the Radio. You can turn on one of the first 5 Scenes to light up the LEDs. For example, tap the On / Off button  at the right for Scene 1, the Party Lights will light up Red, White, and Blue, which is the LED Lighting Mode defined for Scene 1 – Patriot 1.

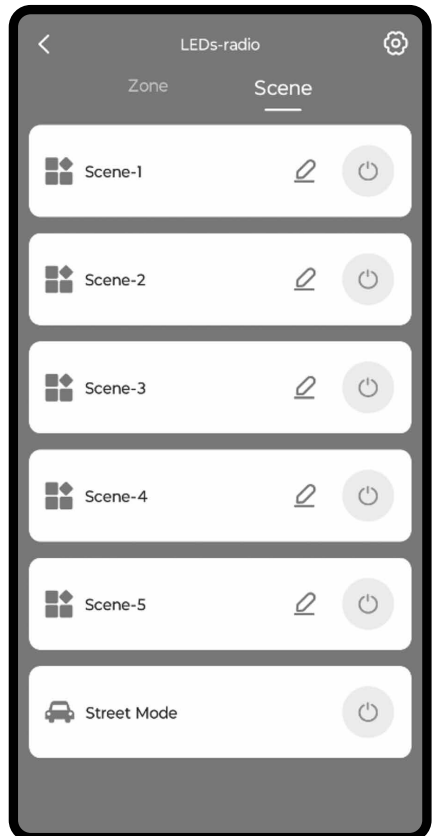
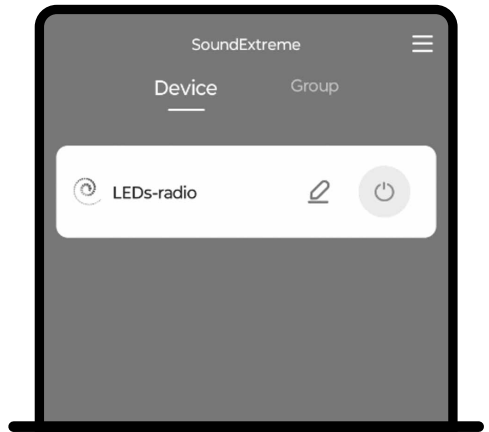

# SoundExtreme App

## Set Up Zones

1. Select your Radio on the **Device List** screen, and the app will bring you to the **Zone** screen.
2. Tap one of the 4 Zones, and you will go to the Zone LED Mode Settings screen. There are 3 tabs: Color, Party, and Music, which allow you to select a solid Color, a Party Mode, or a Music Mode.

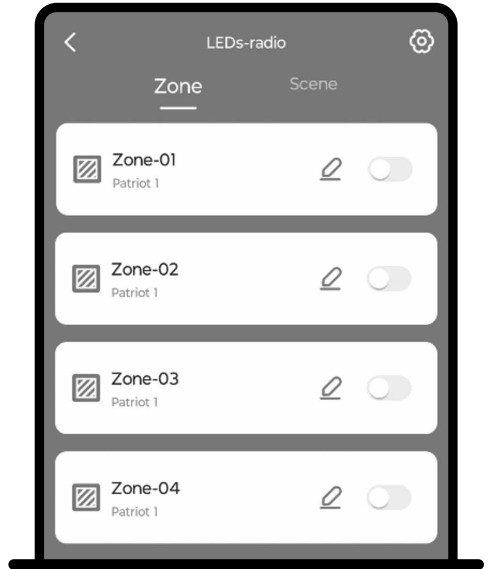

- When you choose a Mode, the LEDs connected to the Zone you selected will light up accordingly, giving you a preview.
- If you tap the **Save** button on the screen, the app will save your setting for the selected Zone.
- If you tap the **Cancel** button or exit the LED Mode Settings screen, your Mode selection will not be saved and LEDs connected to that Zone will display the previously selected LED Mode.

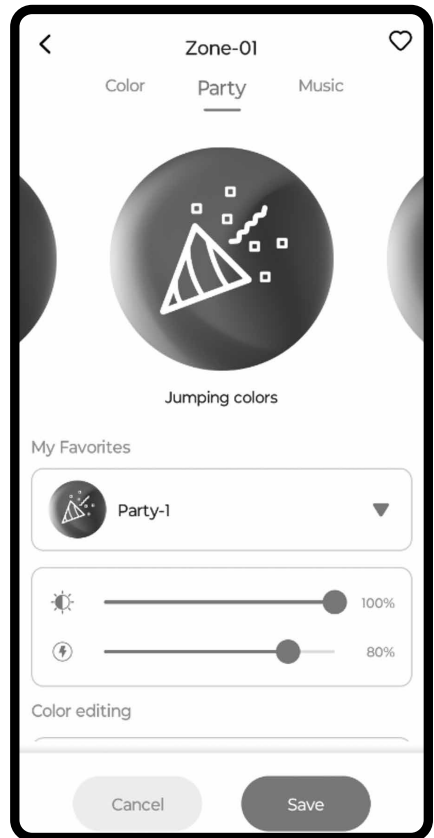

# SoundExtreme App

3. After you set up the Modes for each of the Zones, the controller setup is complete.

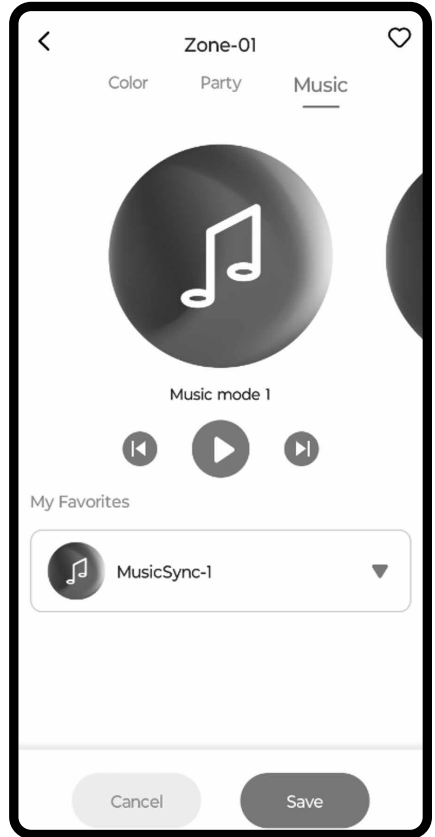

## Set Up Scenes

1. Select your Radio on the **Device** List screen, and the app will bring you to the **Zone** screen. Tap the **Scene** tab. The app will show 6 pre-defined scenes on your Radio's controller. As previously mentioned in **LED Lighting Zones, Modes, and Scenes**, Scene 6 is designed for Street Mode and not editable. Street Mode turns all the lights off but keeps the controller on. If you have the Radio connected to your vehicle's turn signals, brakes and / or reverse wires, the connected LED devices in Zones 3 and 4 will still light up when applicable.
2. You can change a Scene's LED settings by selecting any of the first 5 Scenes. When you select the Scene you will go to the LED Mode Setting screen. You can use the same procedure as in the **Set Up Zones** section to set up each Zone and save the Scene's new LED settings.
3. After you set up LED Modes for all the Zones, the setup is complete for the selected Scene.





# SoundExtreme App

## Change Password

To add extra security, you can change the default password of 0000 to your desired 4-digit numeric password. Please note that the password is stored in your Radio, not the SoundExtreme App. So, after you change the password, please make a note in case you forget your password. The password won't be reset by reinstalling the app or changing to another smartphone. The only way to reset your password is to conduct a factory reset on your Radio.

Follow the steps below to change your password:

1. Select the Menu Icon  at the top-right corner of the screen.
2. Select  **Device Password** from the menu.
3. Once at the Device Password screen, select the device that you want to change the password to.
4. Enter the current password, the new

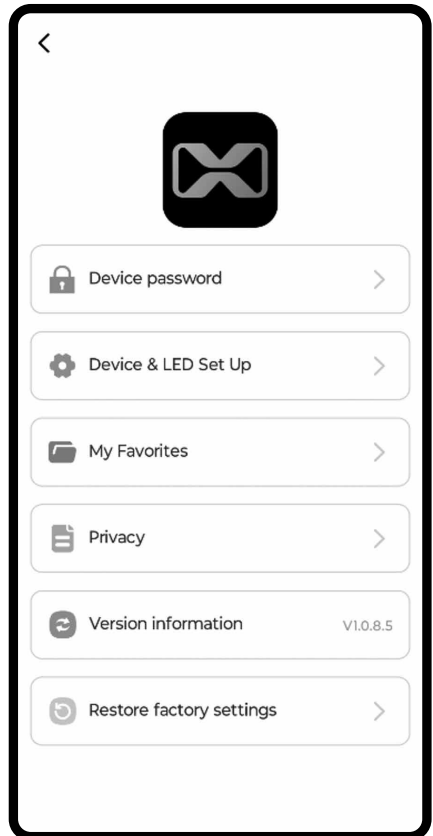
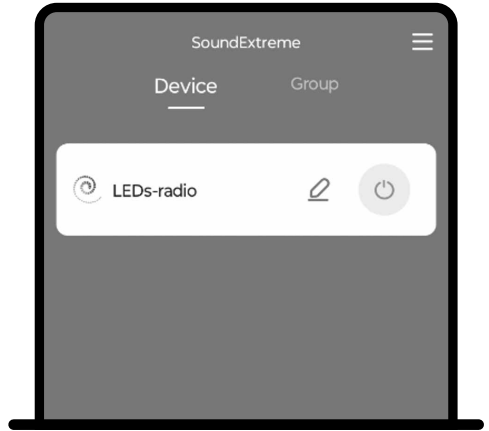



password, and re-enter the new password. Then tap the **Confirm** button.

5. If the change is successfully saved, the app will display a confirmation message.

This is a one-time event. You do not have to enter in your password every time you launch the app, as your app will remember your password.

The screenshot shows the 'Device password' screen in the SoundExtreme app. At the top left is a back arrow, and the title 'Device password' is centered. Below the title are three input fields, each with a label on the left and a placeholder or value on the right: 'Device' with 'LEDs-radio' and a right arrow; 'Current password' with 'password'; 'New password' with 'password'; and 'Reenter new password' with 'password'. Below these fields is a note: '\* The password is 4 characters'. At the bottom of the screen is a large, rounded 'Save' button.

## Factory Reset

If you forget the password, you will need to do a Factory Reset on your Radio so that the password is reset to its default value: 0000.

- On the Radio, press the Menu Button, go to GENERAL > Factory Reset, it will bring up a message asking you to press the Play/Pause Button to proceed with the Factory Reset.

**Note:** Besides the password reset, a Factory Reset will also configure the Radio to all of its original factory settings, as covered under **Radio General Settings**.

## Dimensions

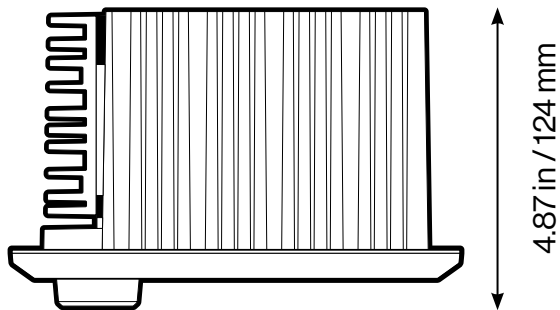
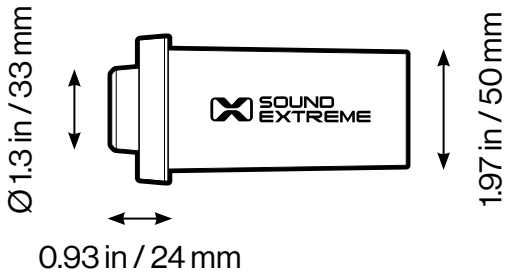
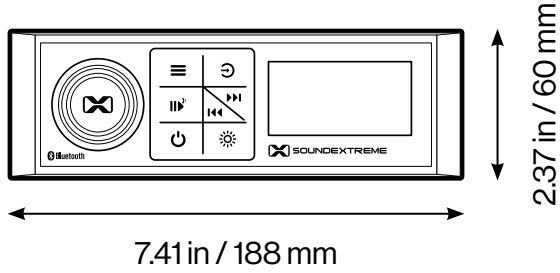

# Specifications

---

## Unit Weight

1.3 lbs (0.59 kg)

## Power Input

12V, 30A, range: 10.5V – 16VDC

## Remote Turn-On Input

### Voltage Range

12 – 56VDC

## Power Input in-line Blade Fuse

35A, 32V

## Display

2.3" Full Dot Matrix LCD

## RF Remote Control

### Operating Frequency

433 MHz

## Audio Source

Bluetooth, FM, AM, Aux In and EcoCast streaming

## Bluetooth

V5.1

## Bluetooth Frequency Band

2.402~2.480GHz ISM Spectrum

## Bluetooth Range

Up to 100 ft / 30m

## EcoCast Range

30 ft / 9.1 m between Transmitting and Receiving speakers

## FM Radio Tuner

### Frequency Range

- USA 87.5 - 107.9MHz
- Europe 87.5 - 108MHz
- Japan 76.0 - 91.0MHz
- Australia 87.5 - 108MHz

## AM Radio Tuner

### Frequency Range

- USA 530 - 1710KHz
- Europe 522 - 1710KHz
- Japan 522 - 1710KHz
- Australia 522 - 1710KHz

## Radio Tuner Presets

- FM – 20 Presets
- AM – 20 Presets

## Aux In Input Gain

### Adjustable Range

±9dB

## Audio Output Zone

2 wired Zones and 1 wireless (EcoCast) Zone

## Audio Outputs

- 2 Zone (4 channel) speaker outputs: 25 W X 4 RMS, 50 W x 4 max @ 4 Ohms
- 2 Zone pre-amplified RCA outputs
- 1 Subwoofer pre-amplified RCA output
- Amp-On signal output – 12V, 200mA max

## Audio Output Controls

- 3 Band EQ: BASS/MID/TREBLE,  $\pm 15$ dB
- Left and right channel balance adjustment
- Volume limit settings
- Subwoofer filter and level adjustment

## Audio Volume Adjustments

- 3 Zone volume control
- 1 Subwoofer volume control

## LEDCast-Enabled

Built-in LEDCast LED lighting controller with 4 (4 zones) control outputs – only compatible with SoundExtreme's LEDCast-enabled LED or speaker products.

## Vehicle Signal Inputs

12V

- Illumination Wire
- Brake
- Reverse
- Left turn
- Right turn

## Front Panel Waterproof / Dust Rating

IP67 (when mounted)

## Storage Temperature

-40°F to 122°F / -40°C to 50°C

## Operating Temperature

23°F to 95°F / -5°C to 35°C

# Important Legal Information

---

## FCC STATEMENT:

This device complies with Part 15 of the FCC Rules. Operation is subject to the following two conditions:

- 1.) This device may not cause harmful interference, and
- 2.) This device must accept any interference received, including interference that may cause undesired operation.

**WARNING:** Changes or modifications not expressly approved by the party responsible for compliance could void the user's authority to operate the equipment.

**NOTE:** FCC's RF Exposure guidelines, this equipment should be installed and operated with minimum distance between 20cm the radiator to your body.

This equipment has been tested and found to comply with the limits for a Class B digital device, pursuant to Part 15 of the FCC Rules. These limits are designed to provide reasonable protection against harmful interference in a residential installation. This equipment generates, uses, and can radiate radio frequency energy and, if not installed and used in accordance with the instructions, may cause harmful interference to radio communications. However, there is no guarantee that interference will not occur in a particular installation. If this equipment does cause harmful interference to radio or television reception, which can be determined by turning the equipment off and on, the user is encouraged to try to correct the interference by one or more of the following measures: reorient or relocate the receiving antenna, increase the separation between the equipment and receiver, connect the equipment into an outlet on a circuit different from that to which the receiver is connected, consult the dealer or an experienced radio/TV technician for help.

## RF WARNING STATEMENT:

The device has been evaluated to meet general RF exposure requirement. The device can be used in portable exposure condition without restriction.

## IC STATEMENT:

This device complies with Industry Canada licence-exempt RSS standard(s). Operation is subject to the following two conditions:

- 1.) This device may not cause interference, and
- 2.) This device must accept any interference, including interference that may cause undesired operation of the device.

## PRODUCT USE AND PROTECTION:

**Read and follow all instructions. Use only as intended.**

The SoundExtreme unit is intended to be used indoors or outdoors and in land or water environments. The unit has been tested to IP66 waterproofing standards, which means the unit can be exposed to dust and water, but should **NOT** be submerged underwater.

To prevent fire or shock, do **NOT** attempt to power this unit if it is wet or you suspect water has entered the unit. In this situation, please return the unit to SoundExtreme for a free assessment. If we have found that the unit has carried water, we will repair or replace the unit free of charge.

## SAFETY ADVISORY & WARNING:

**Read and follow all instructions. Use only as intended.**

**CAUTION:** Do **NOT** open to repair. A qualified technician must carry out repair work.

**ATTENTION:** Do **NOT** connect to a SoundExtreme product with LEDCast technology while the unit is wet. Make sure all connections are dry **BEFORE** connecting to a power source. Failure to do so may result in electrical damage to the unit and may void the warranty.

**⚠ WARNING:** Cancer and Reproductive Harm - [www.P65Warnings.ca.gov](http://www.P65Warnings.ca.gov)

**ATTENTION:** Do **NOT** dispose of in a landfill. Contact SoundExtreme at [www.gracesupport.com](http://www.gracesupport.com) or a certified recycling agent to dispose of the unit.

## SAFETY:

This product has a limited life span of use and should be replaced when it shows obvious signs of wear.

Do not modify or remove any original component parts of the speaker. Doing so could cause damage to the unit, allowing water to ingress. A unit with water ingress should not be charged due to potential risk of fire or shock.

Please exercise care and good judgment when using your SoundExtreme unit.

**You should always**

- 1.) Return the unit to SoundExtreme if you suspect water ingress into the unit or if the unit has experienced a severe impact that may have affected the integrity of the unit to take on water.

# Important Legal Information

---

## You should never

- 1.) Never power your SoundExtreme unit if you suspect water has entered the device. Powering a device with water inside could be potentially hazardous and cause fire or a spark.
- 2.) Never use your SoundExtreme unit if you have dropped it or thrown it against a hard surface which may have destroyed the integrity of the housing. In the event of a severe impact to your unit, please return the unit to SoundExtreme to review for potential damage.
- 3.) Never attempt to fix, repair your SoundExtreme unit. Please send it back to SoundExtreme for any assessments and repairs.

## CARE, MAINTENANCE & PRECAUTIONS:

- 1.) Do **NOT** apply excessive force to any surfaces of the unit.
- 2.) Do **NOT** use or store the unit in places with high temperature.
- 3.) **AVOID** prolonged exposure to ultraviolet radiation (UV sunlight) and strong magnetic fields.

## LIMITED MANUFACTURER'S WARRANTY:

The 1 DIN Marine Radio is covered by a 1-year limited warranty that covers defects in workmanship and / or materials for a period of 1 year from original purchase date. This warranty does not apply to any products which have been abused, neglected, modified or used for a purpose other than the one for which they were manufactured. Please refer to the above care and maintenance instructions for suggested care details. The warranty is valid only for the original owner who purchases the unit from an authorized dealer. Transfers do not qualify for warranty protection. SoundExtreme reserves the right to replace any out-of-stock or discontinued product with a comparable product. Discontinued products may not be available for warranty replacement. Any contents are **NOT** covered by the limited manufacturer's warranty. Warranty terms may be revised without notification at the discretion of the manufacturer. Please visit [www.soundextreme.us](http://www.soundextreme.us) for additional product & warranty information.



1 DIN Marine Radio by SoundExtreme Inc., Houston, Texas.  
Designed in Texas. Made in China.

## What's in the Box

---

- 1 DIN Marine Radio
- 8 feet 12 AWG SAE Power Cable
- Remote Turn-On Extension Cable
- Vehicle Signal Input and Speaker Output Connection Cable Harness (J1)
- Audio Input and Output RCA Cable Harness (J2)
- LED Lighting Control Output Cable Harness (J3)
- EVA Gasket
- DIN Mounting Cage
- 4x30 BM Screws
- (2 pcs) Side Screw Cover
- DIN Mounting Plate
- (4 pcs) 4x25 PA Self-Tapping Screws
- Mounting Template
- RF Remote Control
- 1 DIN Marine Radio User Guide
- 1 DIN Marine Radio Installation Guide

V08.23