

# TURNTABLE WITH EXTERNAL SPEAKERS

**Model:R612 PRO**



✉ [support@retrolifeplayer.com](mailto:support@retrolifeplayer.com)

🌐 [www.retrolifeplayer.com](http://www.retrolifeplayer.com)

# Introduction

Thank you for purchasing this turntable with external speakers. This instruction manual contains important information about safety, usage, and disposal. Use the product as described and keep this manual for future reference. If you sell this turntable or pass it on, also give this manual to the new owner.

# Safety Instructions

Read and understand this entire manual before using this product. Keep these instructions for future reference.

1. Do not use the turntable near water.
2. Only connect the turntable to a power outlet type as indicated on the marking label or in the "Specifications" section of this instruction manual.
3. The turntable has a polarized plug (one pin is wider than the other). To reduce the risk of electric shock, this plug is intended to fit into a polarized outlet in only one orientation. If the plug does not fit fully into the outlet, reverse the plug. If it still does not fit, contact a qualified electrician. Do not attempt to modify the plug in any way.
4. Protect the power cord from being walked on or pinched, particularly at the power plug, at the point of connection between the plug and outlet, and between the power cable and speaker.
5. Do not overload wall outlets on extension cords as this will be a fire hazard and may cause electric shock.
6. Never push objects of any kind into the turntable through openings as they may touch dangerous voltage points or short-out parts that could result in a fire or electric shock. Never spill liquid of any kind on the product.
7. Do not attempt to service the turntable yourself as opening or removing body panels may expose you to dangerous voltage or other hazards. Refer all servicing to qualified service personnel.
8. Changes or modifications to the turntable not expressly approved by the party responsible for compliance could void the user's authority to operate the product.
9. Do not use attachments not recommended by the manufacturer as they may cause hazards.
10. Only place on a flat, sturdy table or use the cart, stand, tripod, or bracket as specified by the manufacturer or sold with the turntable. When a cart is used, use caution when moving the cart/turntable combination to avoid injury from tip-over.



11. Slots and openings in the cabinet are provided for ventilation to ensure the reliable operation of the product and to protect it from overheating. Do not block or cover these openings.

12. Unplug the product during lightning storms or when unused for long periods of time.

## CAUTION:

**TO PREVENT ELECTRIC SHOCK, MATCH THE WIDE BLADE OF THE PLUG TO THE WIDE SLOT. FULLY INSERT THE PLUG INTO THE MAIN POWER SOCKET.**

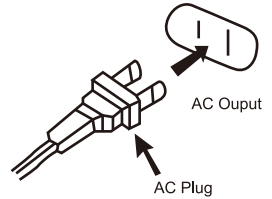

## Product Description

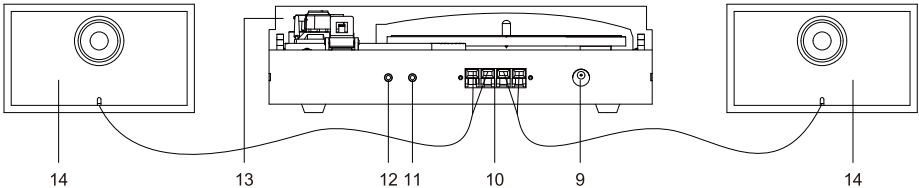
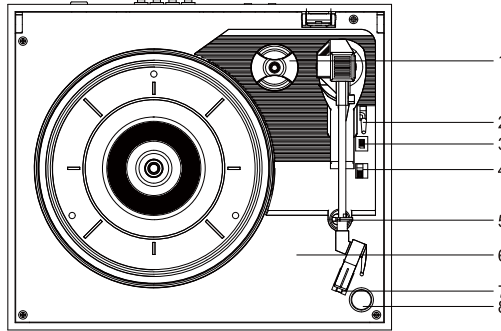

- |                                |  |
|--------------------------------|--|
| 1. 45RPM Adapter               | 9. 12V 2A DC Power Jack                |
| 2. Tonearm Lift Lever          | 10. RCA Line Out/External Speaker Clip |
| 3. Phono/Bluetooth Switch      | 11. Headphone Jack                     |
| 4. 33 1/3,45,78 Speed Selector | 12. AUX-in Jack                        |
| 5. Tonearm Lock                | 13. Dust Cover                         |
| 6. Turntable                   | 14. External Speakers                  |
| 7. Stylus Needle               |  |
| 8. Power Button/Volume Knob    |  |
- Rotate R/L To Turn On/Off  
-Rotate R/L To Turn Up/Down the Volume

## Included Items

Before installing the turntable, check the package contents to ensure all parts below are included and free of visible damage. Please retain the original packaging materials for exchange or return purposes.

1. Turntable Unit R612\*1 PC
2. External Speakers\*2 PCS
3. Power Adapter(DC 12V 2000mA)\*1 PC
4. 45 RPM Adapter\*1 PC
5. Instruction Manual\*1 PC
6. Detachable Dust Cover\*1 PC

### Note:

Please contact our after-sales technical team: [support@retrolifeplayer.com](mailto:support@retrolifeplayer.com) if there is any accessory missing from the package.

## How to Store or Transport Easily

Using the product's original packing materials, wrap the turntable in the reverse order from when you unwrapped it. If you do not have the packaging materials, take the following measures:

1. After disconnecting the AC adapter from the outlet, remove the vinyl record, down the lift lever, lock the tonearm, remove the speakers' line from the clip, put away the 45-speed adapter
2. Attach the stylus protection to the cartridge.
3. Use a string or something similar to tie the tonearm to the rest so that it does not become dislodged.
4. Wrap the power adapter, turntable, and speakers with paper or soft cloth so that it does not get damaged.

## Main Power Connection

1. Insert the 12V 2000mA DC plug of the AC adapter cord into the DC INPUT Jack at the back of the turntable.
2. Plug the AC adapter into a normal power outlet(100V~240V).

### NOTE:

- Do not plug the AC power adapter into a power outlet before all turntable assembly is completed. Before turning on the turntable power.
- Recheck all connections to make sure they are correct and secure, Always turn off the turntable before connecting or disconnecting from power.
- Please do not use an adapter that exceeds the appropriate specification, otherwise it will cause a short circuit to the appliance and damage the internal circuit.

# Connection to External Speaker with RCA Audio Cable

This turntable includes 2 external dual speakers and a built-in phono amplifier(not built-in speakers). If you wish to use your amplifier or speakers, select the PHONO Switch to set the output, please follow the instructions below:

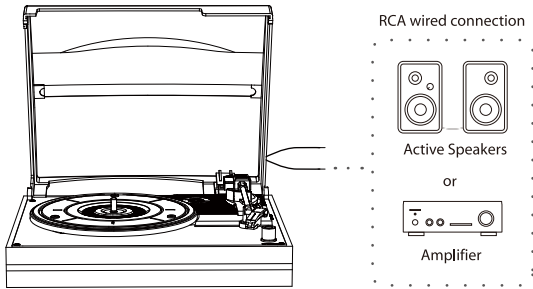

## NOTE:

To achieve the best sound, it is advised to set the turntable volume to a minimal level. The turntable audio will be played through your amplifier/speakers.

## Where to connect RCA audio cable

1. Connect external speakers/the Amplifier to the speaker clip on the back of the unit.
2. Whilst you can listen to your new turntable using the external speakers/the Amplifier, you may wish to connect it to your existing HI-FI system, and connect the audio plugs to the AUX input on your mixer or amplifier using an RCA cable(not supplied).
3. Connecting the device

Align the settings for the PHONO selector switch and connect the RCA audio cable to an input jack that is compatible with the connectable equipment you are using (amplifier, active speakers, etc.).

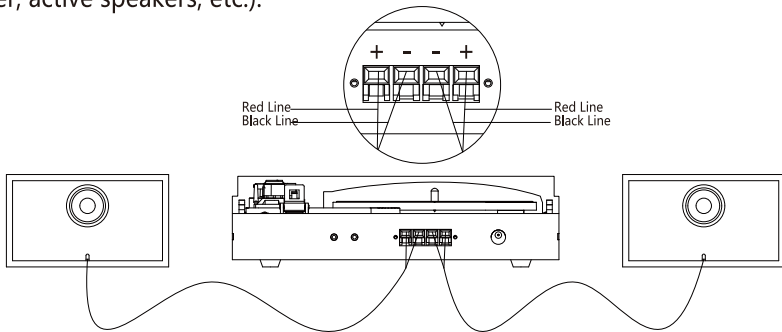

## NOTE:

The RCA Jacks are not designed to be connected directly to the passive/unpowered speakers. If connected to the passive speakers, there will be no sound.

# Playing a Record

## 1. Before playing a record

(1) Remove the stylus protector from the cartridge and avoid touching the needle.

### NOTE:

- Do not touch the needle directly, it may cause the needle to break
- Pinch the sides with two fingers, making sure not to shift the cartridge
- Applying a downward force may cause the cartridge stylus to come off the body. If the stylus has come off or is about to come off, so refer to "Replacing the stylus" to reattach the stylus correctly.

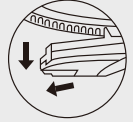

- (2) Place the record on the turntable so that the center hole aligns with the spindle.
- (3) Use the Lift Lever to lift up the tonearm, drop the tonearm on the record, then select the PHONO mode with the prompt tone, and it successfully enters LP playback mode.
- (4) Turn the power knob to the right to adjust the volume and turn off the unit counterclockwise.

## 2. Turntable Operation

Sufficiently lower the volume of the amplifier and speakers first.

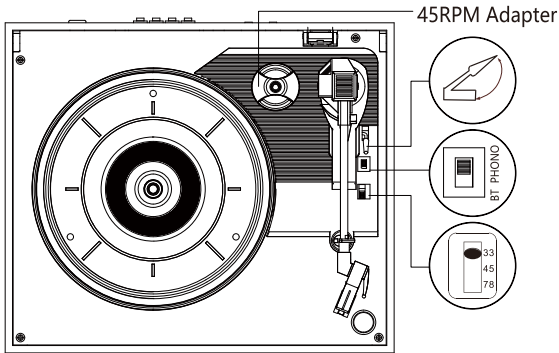

(1) Connect the power adapter to turntable, and turn on the power button. Remove the stylus protector from the stylus.

(2) Switch 3 speed selector to choose the 33 1/3, 45 and 78 RPM according to the type of record. Use the 45 RPM adapter if necessary.

(3) Unlock the tonearm clip and up the tonearm lift lever after place the record on the turntable.

(4) Carefully lower the tonearm on the record.

(5) Choose the PHONO button and the turntable will start turning. Turn up the volume of the turntable as needed.

(6) Turntable will stop spinning automatically to protect the record when finishes playing. Raise the tonearm after playing end, return it on the arm lock, and turn off the turntable.



45RPM Adapter

# Bluetooth Operation

1. Connect the included power adapter to the turntable and power this unit with the volume knob.
2. Switch the function knob to Bluetooth mode. You will hear an activation sound from the turntable.
3. Turn on the Bluetooth feature of your media device and search for and select "Turntable" to pair the media device and turntable.
4. Once your media device is successfully paired with the turntable, the turntable will play a short confirmation sound.
5. Play and stream music from your media device to the turntable.

**Note: Bluetooth version: -\*5.0\***

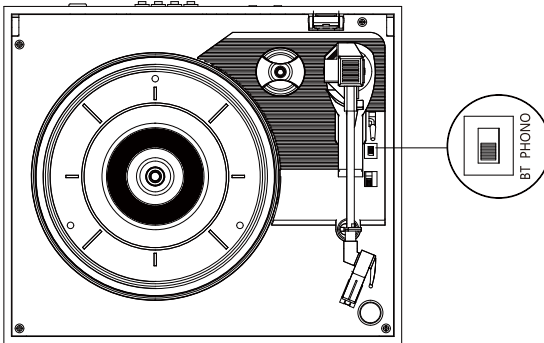

## NOTE:

1. The Bluetooth connection may disconnect, such as some strong interference, beyond the connection distance or an object moving in between both Bluetooth devices. However, most devices can be reconnected in seconds automatically, but some devices may need to reconnect by using the Bluetooth device's list menu manually.
2. There are many Bluetooth versions that could be installed into different types, and connection methods will have differences. If you cannot connect it, please contact us via [support@retrolifeplayer.com](mailto:support@retrolifeplayer.com).

## Disconnect from Paired Device

1. To disconnect the Bluetooth and select another mode, please directly select the "PHONO" mode to switch the record mode.
2. You can choose to disconnect the Bluetooth name of "Turntable" in the Bluetooth device list by pairing the device. However, most devices will automatically reconnect with the paired device again within a few seconds. Please turn off the Bluetooth function of the Bluetooth device if needed. Turning off the phone's Bluetooth signal.
3. If the Bluetooth device is disconnected from the paired device due to turning off the paired device, if needed, manually reconnect them or turn off the record player.

## AUX-IN Operation

This turntable includes an auxiliary audio signal input jack for connecting external audio devices like MP3 players, CD players, and older, non-dockable iPad so you can listen to your external source through the turntable's speakers.

1. Use an audio cable (not included) with one 3.5 mm stereo connection on each end of the cable.
2. Plug one end into the AUX-IN jack on the turntable and the other end into the Line Out jack of the audio device.
3. Power on the turntable and audio device. The indicator light of the turntable is red.
4. The volume level can be controlled through the turntable. Operate all the functions on the auxiliary device as usual.
5. Please unplug the AUX-IN cable before using the PHONO/BT functions.

### NOTE:

- Make sure the tonearm is securely locked to avoid any damage.
- When you are done, don't forget to turn off the power on the turntable and your external device.

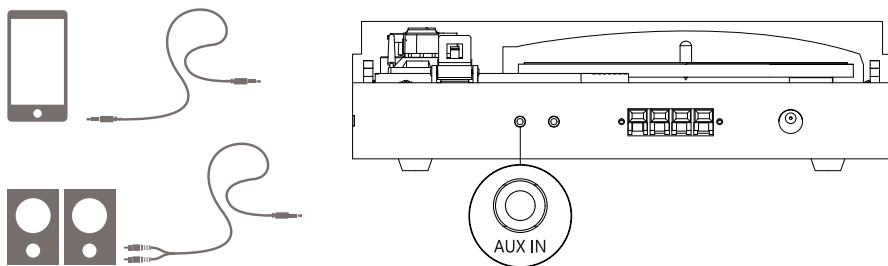

## Maintenance and Cleaning

### 1. Turntable Body

- (1)When the turntable body is dirty or dusty, first disconnect the AC adapter and then clean the turntable dust cover and turntable table with a slightly dampened microfiber cloth.
- (2)Do not use benzenes, thinners, etc.
- (3)Don't clean the inside of the device.
- (4)Don't attempt to repair the device. If the device does not operate correctly, replace it with a new device.
- (5)Don't immerse the device in water or other liquids.
- (6)When storing the product for a long time:
  - Disconnect the AC adapter from the outlet and wrap the product in a plastic box.
  - Do not allow it to become damp.



## 2. Stylus Tip

(1) Do not touch the needle directly with your hands.

(2) Avoid bumping the stylus on the turntable mat or a record's edge.

(3) If dirt and grime are stuck to the stylus tip, clean it with a soft brush.

(4) We recommend using a stylus cleaner (not included) if the stylus tip is considered dirty. Clean the stylus tip by moving the brush from the rear to the front of the stylus tip.

(5) Clean the records to get rid of dust or grease with a record Cleaning brush and record cleaning solution.

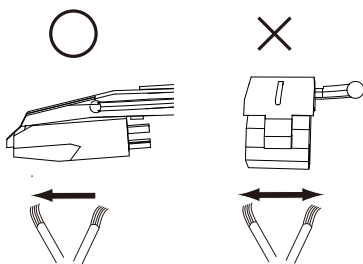

## Replacing the Stylus

It's suggested to replace the stylus after 250 hours of use.

### Removing the Stylus

- In addition to the deterioration of sound quality, records may also be damaged as the cartridge's stylus tip wears down.
- Be sure to disconnect the product's AC adapter from the outlet.
- When replacing the stylus, hold the headshell and the cartridge body tightly. Rotate the front of the stylus in a forward and down motion (Figure A).

### Installing a New Replacement Stylus

1. Mount the new replacement stylus to the cartridge.
2. Lift the stylus up until you hear a click.
3. Make sure there is no gap between the headshell and the cartridge (Figure B).

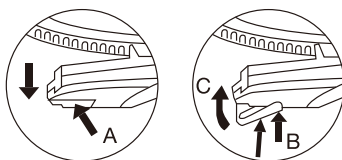

### Replacing the Cartridge:

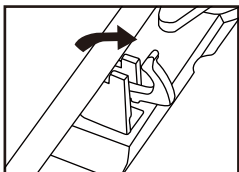

1. Push the arm lock to release the tonearm

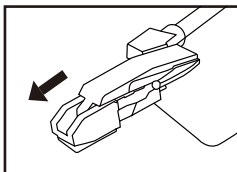

2. Take off the cap of the cartridge to expose the needle out

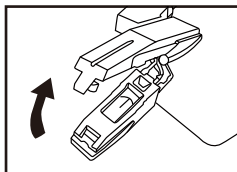

3. Separate the cartridge from the socket lightly

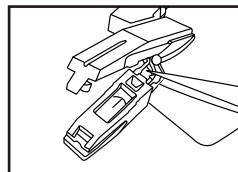

4. Take off the audio line from the cartridges completely

To fit a new one just in opposite deals, insert the audio line accordingly, and install the cartridge to the socket lightly.

## Replacing the Belt

- The belt is a consumable part. Replace the belt if the speed of playback slows down or regular rotation occurs. As a rule of thumb, we suggest replacing the belt once a year.
- Before replacing the belt, be sure to disconnect the product's AC adapter from the outlet.

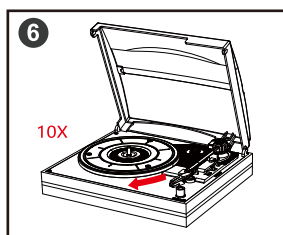
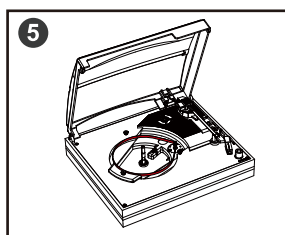
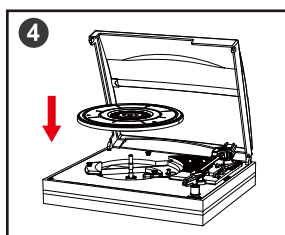
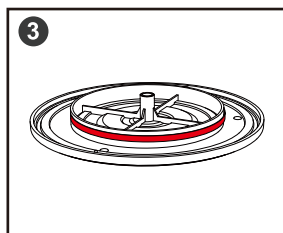
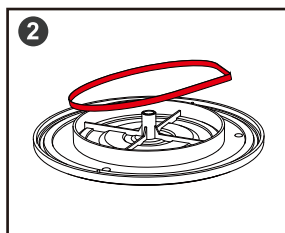
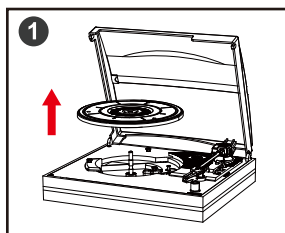

1. Remove the retaining ring of the turntable and spindle.
2. Remove the main platter and then remove the old belt.
3. Turn the platter over and you will see a raised circle. Loop the new belt along the middle circle evenly.
4. Place the belt on the motor pulley.
5. Grasp the belt that was attached in step 3 and, while pulling it, places it on the motor pulley.
6. Using your hands, slowly rotate the platter ten times in a clockwise direction. After confirming that there is no problem with normal rotation, you can install the fixing ring that fixes the turntable and the spindle back.

# Troubleshooting

Problem:	Solution:
<p>The platter does not spin.</p>	<ol style="list-style-type: none"> <li>1. Is the AC adapter connected to the outlet? -Connect the AC adapter to the outlet.</li> <li>2. Is it correct to select the record mode in this selector "PHONO and Bluetooth" ? -Select the "Bluetooth". That means the turntable is in Bluetooth mode. Please switch the function knob to "PHONO" turntable mode.</li> <li>3. Has the belt slipped from the platter? -Correctly place the belt on the platter.</li> <li>4. Is the belt placed on the motor pulley? -Check that the belt is placed on the motor pulley correctly.</li> <li>5. Has the belt been damaged? -Replace it with a new belt.</li> <li>6. Is the AUX-IN cable plugged in? - Please unplug the AUX-IN cable before using the PHONO/BT functions.</li> </ol>
<p>The turntable platter spins, but there is no sound from the turntable.</p>	<ol style="list-style-type: none"> <li>1. Is the stylus damaged? -Check the stylus and replace it, if necessary. It's suggested to replace the stylus after 250 hours of use.</li> <li>2. Is the stylus placed correctly on the body of the cartridge? -Check the cartridge and adjust it, if necessary.</li> <li>3. Are speakers or amplifiers connected? -Use RCA cables to connect speakers or amplifiers to the turntable.</li> <li>4. Are the RCA cables connected to the speakers in the wrong place? -The RCA audio cables "-" jack is for the right (R) channel, and the "+" jack is for the left (L) channel.</li> <li>5. Are the connected speakers passive speakers? -The RCA Jacks are not designed to be connected directly to the passive/unpowered speakers. If connected to the passive speakers, there will be no sound.</li> <li>6. Is the plastic of the line part clamped when the RCA line is connected to the speakers? -It needs to be clamped to the copper wire and not to the plastic, otherwise, a complete circuit cannot be formed to make the speakers work.</li> </ol>

<p>The stylus skips</p>	<ol style="list-style-type: none"> <li>1. Is the record warped/scratched? -Check the record. Test a few more records to see if the same thing happens. Long-term use of records will wear out and cause skipping during playback.</li> <li>2. The needle part of the stylus is not properly centered -The needle position needs to be in the middle of the track to play along the record correctly. -The wear level of the stylus will cause skipping, please replace it with a new stylus</li> </ol>
<p>The turntable is making a strange 'howling' sound.</p>	<ol style="list-style-type: none"> <li>1. Is the product picking up excessive vibrations from the floor, surfaces of the walls, or nearby speakers? -Decrease the vibrations or mount the product on a surface that is not subject to the effects of vibrations.</li> <li>2. Is the product mounted on an unstable surface? -Check if the surface of the product is mounted and suitable.</li> </ol>
<p>There is noise when the record is playing.</p>	<ol style="list-style-type: none"> <li>1. Is there dust on the cartridge's stylus tip? -If dust is stuck to the stylus tip, clean it with a commercially sold brush.</li> </ol>
<p>The sound when the record is playing is either too fast or too slow.</p>	<ol style="list-style-type: none"> <li>1. Are the speed settings for this product correct? -Please select the correct speed for the type of record being played</li> </ol>
<p>Playback speed slows down or there is irregular rotation.</p>	<ol style="list-style-type: none"> <li>1. Is the belt stretched out? -Replace with a new belt.</li> <li>2. Is the belt installed correctly? -Refer to "Turntable Platter and Belt Setup" to set up the belt.</li> </ol>

# Specifications

## Turntable

Model	R612 PRO
Normal Speeds	33 1/3, 45&78 RPM
DC Power Supply	DC 12V 2000mA
AC Power Adapter	Input: AC100~240V 50/60Hz, Max. 600mA
Power Consumption	20W
Output Power(RMS)	8Ω 9W*2(BT) , 1.6W*2(PH CR4005)
Dimensions(L*W*H)	320*270*92mm/12.60*10.63*3.62in
Weight	1.85kg/4.08lbs

## Stylus

Model	Universal Ruby Stylus NS49
Frequency Response	80HZ–10KHZ
Channel Balance	≤3dB
Channel Separation	≥15dB
Output Voltage	170 ~280MV
Recommended Load Resistance	470KΩ
Amplifier Connection	CRYSTAL–input
Recommended Tracking Force	5.5+0.5g
Weight	0.088oz(2.4g)

**Note:** Design and specifications are subject to change without notice.

# Disposal

## Disposal of the Product



This marking indicates that this product should not be disposed of with other household wastes. To prevent possible harm to the environment or human health from uncontrolled waste disposal recycle it responsibly to promote the sustainable reuse of material resources.



This product's packaging is made from environmentally friendly material and can be disposed of at your local recycling plant.