

Portable Child Table Clamping Chair

Model : H101

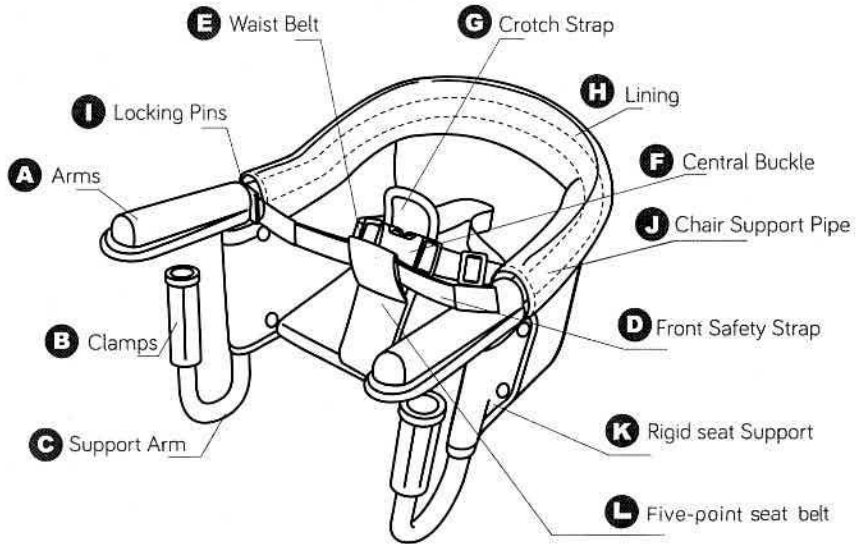

NOTE:

1. Please read the instructions and warnings thoroughly before installation, in case of any accident caused by improper operation.
2. Please check the seat each time before using it.
3. Please contact us by "Please fill in the Email here" if you have any question about the use of the seat.
4. "Portable Child Table Clamping Chair" hereinafter referred to as "hook-on chair".

READ ALL INSTRUCTIONS BEFORE ASSEMBLY OF CHAIR.

KEEP INSTRUCTIONS FOR FUTURE USE

1. How to assemble the chair

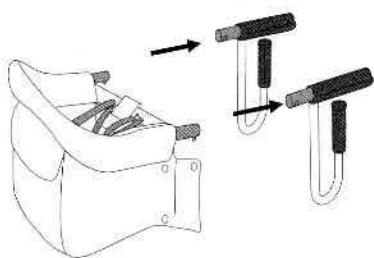

1. Insert two iron pipes of the fixing bracket into the tube of the chair through two round holes.

2. Insert the iron pipe to the point where the metal pin pops up.

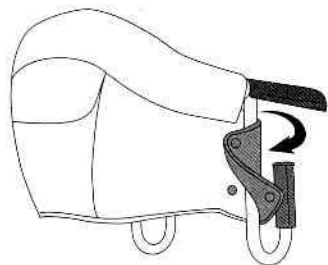
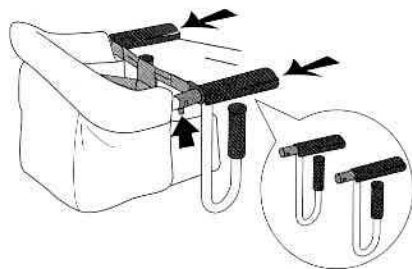

3. Cover the cloth to the support arms and fasten the safety buckles.

2. How to position the chair

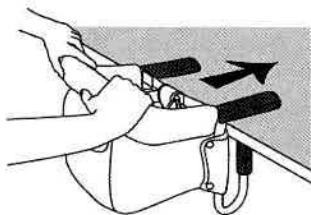

1. Place the hook-on chair to the table and slide the arms along the top till the edge of the table.

2. Tighten the clamps counterclockwise until reaching the bottom of the table

Note: If the rotary knob is loose, it would cause injury.

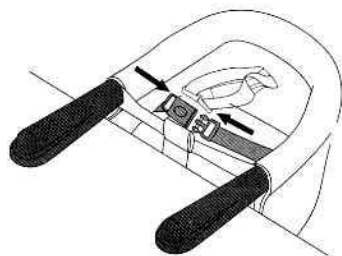
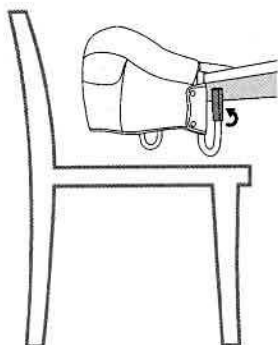

3. Fasten the seat belt after your baby is well seated.

3. How to use the safety belts

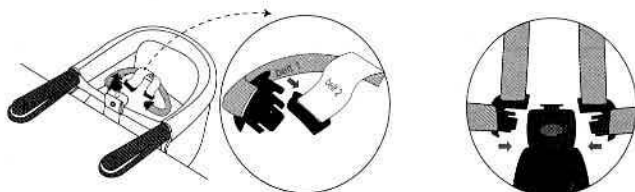

4. Insert the end of belt 1 to the end of belt 2.

5. Insert the two clips on the ends of the waist belt into the central buckle attached to the crotch strap.

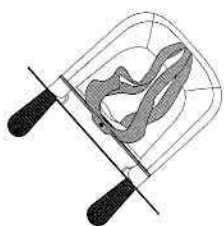

6. Loop the end of the crotch strap over the central buckle.

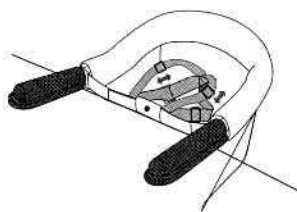

7. Be sure to properly tighten the waist belt after placing the child in the hook-on chair

4. How to disassemble the chair

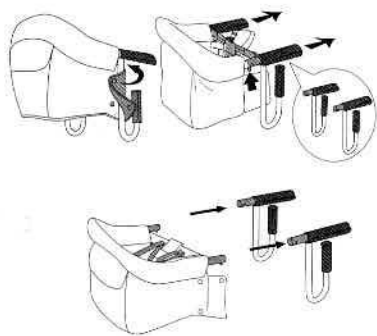

1. Unzip the lower support arm cover over the support arms. Loosen the clamps by rotating them clockwise. Remove hook-on chair by pulling it away from the table.

2. Rotate the support arms inward and upward for storage

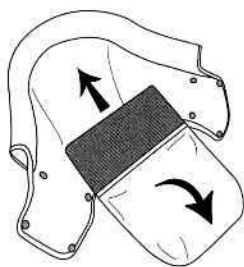
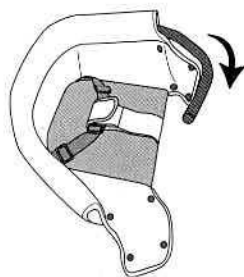

3. Remove the cushion plate.
Note: you must remove the plate when you clean the hook-on chair, or some damages might be caused.

5. Storage

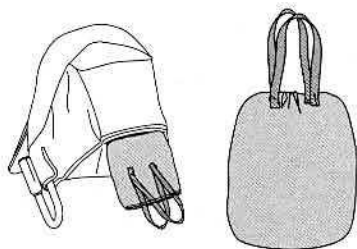

6. Warnings

1. READ THE INSTRUCTION BEFORE ASSEMBLY AND USE.
2. KEEP THE INSTRUCTION FOR FUTURE USE.
3. AMERICAN SAFETY STANDARD ASTM F1235-18

▲ WARNING

Failure to follow all warnings and instructions could result in injury or death.

Fall Hazard. To prevent falls:

- **ALWAYS** use restraints. Adjust to fit snugly.
- Keep child in view.
- To prevent tip over, check stability of table before and after seating child.
- **NEVER** use with:
 - × glass table top
 - × loose table top
 - × single pedestal table
 - × card table
 - × table leaf
 - × table cloths or place mats
- Child can use nearby supports to kick or push off table or counter.
NEVER use hook-on chair:
 - × with ordinary chair underneath
 - × in reach of table legs
 - × near island below counter tops

Use only for:

- child who can sit upright without help.
- child up to 37 pounds (16.8 kg).
- tables 0.8" to 3.3" in. thick (20 to 85mm).

● Discontinue use if child, when seated in hook-on chair, is able to move the hook-on chair's arms on the table top.

● Before removing child from hook-on chair, be sure child's legs are free from hook-on chair supports.

● Discontinue use if hook-on chair is broken. Contact manufacturer immediately for replacement parts or service.

● Do not use without all tips (including suction cups or other locking / latching mechanisms) attached securely to table surface.

● Do not allow other children or animals to play near or walk under the hook-on chair while in use.

ADDITIONAL SAFETY INSTRUCTIONS

- Not all tables are suitable for attachment of the hook-on chair. Do not use the hook-on chair if in doubt.
- Remove and discard all packaging materials before using the hook-on chair, including plastic bags, and keep these materials out of the reach of newborns and children to avoid suffocation.
- Do not use the hook-on chair on a table that has any screws, staples, sharp edges, holes or gaps, on the top or bottom surface, which might injure the child.
- Do not use tablecloths or other objects on the tabletop which might interfere with the proper functioning of the anchoring elements.
- Keep table and seat clean and dry to prevent slipping.
- Do not allow children under six months to sit in the hook-on chair.
- The hook-on chair has been designed and tested for use with only one child.
- Do not attach objects (such as pocket books or diaper bags) to the hook-on chair as this may affect the stability and safety of the product.
- Do not attach the hook-on chair to drawers or movable parts of tables.
- Routinely check any clamping screws and re-tighten them if necessary and check the suction pads as well.

- Stop using the product when the child is able to stand on his/her own.
- Make sure the hook-on chair is securely attached to the table before seating the child.
- Never leave the hook-on chair with the child seated in it where ropes, curtains or other objects may be used by the child to climb or cause the suffocation or strangling of the child.
- Always ensure that all hazards such as electrical devices, knives and hot liquids are kept out of the reach of the child in the hook-on chair.
- Assembly, disassembly and adjustment operations must be carried out by adults. Make sure that the person using the product, such as baby-sitter, grandparent, etc. reads this manual and has a full knowledge of the correct operation.
- When the hook-on chair is not being used, it should be stored out of the reach of children. The hook-on chair should not be used as a toy.
- In case of prolonged exposure to sunlight, let the hook-on chair cool before using it.

CLEANING AND MAINTAINANCE

- Don't store the product if it is still wet and don't leave it in humid environments as mildew may form.
- Store the product in a dry place.
- Clean the plastic and metal parts with a wet cloth or with a mild detergent; do not use solvents, ammonia or benzine.
- Carefully dry metal parts after any contact with water in order to avoid the formation of rust.
- Keep all moving parts cleaned.

CLEANING OF THE FABRIC SEAT

- Wash the seat separately from other items.
- Routinely clean the seat with a soft brush for garments.
- Follow the washing instructions on the seat lining
- Dry the seat completely before using or storing it

Chair Components:

- A: Arms
- B: Clamps
- C: Support Arms
- D: Front Safety Strap
- E: Waist Belt
- F: Central Buckle
- G: Crotch Strap
- H: Lining
- I: Locking Pins
- J: Chair Support Pipe
- K: Rigid seat Support
- L: Five-point seat belt

Before assembling confirm that the hook-on chair and its components have not been damaged during transport or handling. If any damage exists, no matter how slight, DO NOT USE THE CHAIR.