



LIFT eFOIL

User Manual

User Manual



TABLE OF CONTENTS





Introduction	06
Safety Warnings & Disclaimers	10
Warranty	10
General Warnings	11
Ride Safety	11
Propulsion System	12
Battery	13
Lift Battery Safety	14
Getting to Know the Lift eFoil	16
How the Lift eFoil arrives	16
Components	18
Charging the Battery	26
Assembly	30
Getting Ready to Ride	34
Installing the Battery	34
Booting Up the System	36
Pairing the Controller	38
Riding the eFoil	40
Post Ride	42
Powering Down	42
eFoil Maintenance & Storage	42
Battery Maintenance	44
Battery Storage	45
LIFT App	46
Troubleshooting	48

A NOTE FROM LIFT FOILS FOUNDER

NICK LEASON

To those close to the foiling community, it may seem we've entered the mainstream, but I believe that the sport is just getting started. We're finally starting to see small groups of surfers adopt the foil for their small wave needs. In wind sports, wing foiling is officially taking over. Kitesurfers are making a complete move, and windsurfers who haven't contemplated rigging a sail in the last 20 years are now coming out of retirement to start winging on a foil board. In the world of electric, more and more eFoilers are starting to pop up in the wild and as houseboat owners cruise around with multiple outdated jet skis on the aft deck, they ask themselves, **"Why don't we have one of those?"** The first person foiling was a kook, when it was two people they were weird, and now, with gangs of foilers at local breaks and WhatsApp groups excitedly messaging each other about one-foot surf, we have ourselves a movement. If you look closely at the strange trends, you can start to visualize the evolution of a new sport with multiple segments.

I see two advancement trends in foiling. The first is the early advocates, the ones who have been on the edge of the sport for years, who are going to achieve levels of mastery that are simply beyond what we can even comprehend today. I see it now with riders we work with at Lift. Some are only a few years into foiling, some are still in high school, but they're doing flips and tackling waves that seemed insurmountable to pioneers just a year ago. I firmly believe these riders are going to be flying out of barrels, riding huge waves at incredible speeds, and doing acrobatics similar to what we see in the world of snowboarding. Have a look at what people achieve behind a boat on an Air Chair and then combine that with fearless young surfers on large waves, light equipment, and foot straps. These young guns may even adopt an eFoil as the tool needed to get them launched into such surf...

The second is that we're going to see the infrastructure building quickly for further mainstream adoption, education, and enablement of new riders in all types of foiling. This is going to mean more brands jumping into the sport, more schools and lesson opportunities, and an increased desire from people of all skill levels to try foiling. The multiple branches

of foiling—surf, SUP, wake, kite, wingdings, eFoils—are what will create so much attention and what will offer an avenue for everyone. We've signed up hundreds of schools and rental areas to represent and showcase Lift eFoils in the last two years alone, and that speaks to the excitement that's going to continue across all areas of the sport.

Foil designs and equipment will continue to evolve. Wing designs will start to be refined for more specific applications. Just as you have different surfboards for different kinds of surfing, the same is true of hydrofoil designs. I think the most exciting will be the adoption of smaller wings as foilers discover an incredible amount of speed and maneuverability in more powerful surf. Glider wings will allow for the endless riding of small waves and the ability to tap into open ocean swells and chop. It will no longer be people riding at specific breaks but instead riding their entire coastline...

Winging will allow for a new wave of excitement in the world of sailing as new people take an interest once again in the ancient art of riding the wind. What's most exciting is that "non-surfers" will learn to wing foil and surf open ocean swells in a matter of a few lessons—something that traditional surfers have never dreamed of. Skilled sailers will create rigid wings (true foils) that allow them to reach new speeds and a whole new category of racing. The world of electric foiling is endless and new crafts will appear that will excite just about everyone. The combination of tech and tradition will soon meld into new levels of the sport. Just wait and see what we have in store for you.

At the end of the day, it's no longer a question of whether or not foiling will become a mainstream sport; we're past that phase. It's a question of **how far we can take it**. I have so many ideas flowing that as soon as I finish one new design, I'm seeing three more in front of it. The potential is crazy, and as the community continues to expand, everyone will contribute more and more to the development of the sport. That's the most exciting part of it all: community, and finding new levels of stoke with your peers, and sharing new ideas that shape the next level of surfing for everyone.

—Nick Leason, CEO and Founder of Lift Foils
© Foiling Magazine, 2020

eFOIL OVERVIEW



- ① Hatch Compartment
- ② Mast
- ③ Propeller
- ④ Board
- ⑤ Bluetooth Antenna

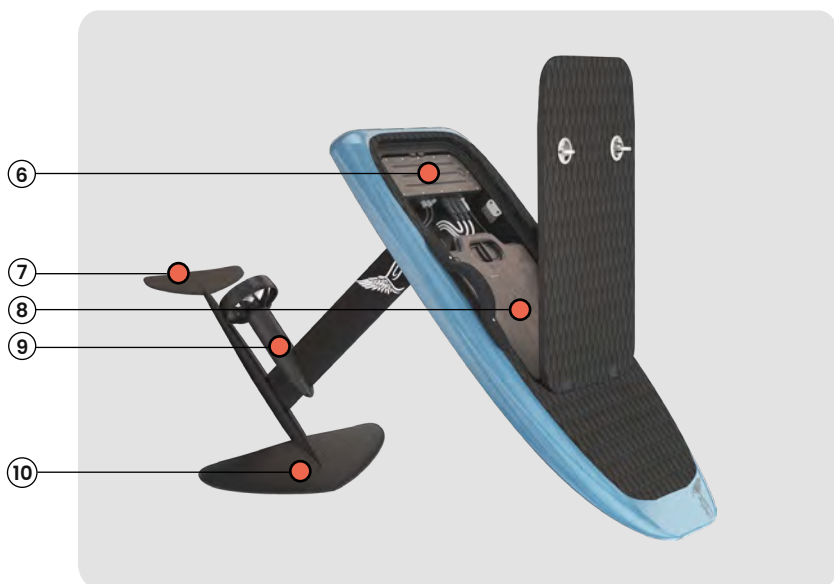

- ⑥ eBox
- ⑦ Back Wing
- ⑧ Battery
- ⑨ Motor
- ⑩ Front Wing

SAFETY WARNINGS & DISCLAIMERS



USE OF THIS PRODUCT AND PARTICIPATION IN THE SPORT INVOLVES INHERENT RISKS OF INJURY OR DEATH. BY USING THE PRODUCT, THE USER ACKNOWLEDGES AND ACCEPTS THIS.

FULLY READ THIS MANUAL BEFORE USING THE PRODUCT.

The information contained in this User Manual represents the most up-to-date product data available at the time of release. Lift Foils is committed to continuous product improvements and advancement of technology and the company reserves the right to change the product, components, specifications, or other aspects of the Lift board without advance notice.

The most current information can be found on the Lift Foils website:

www.liftfoils.com

WARRANTY

The Lift eFoil is subject to a two-year manufacturer's limited warranty. The earlier of one year or 300 battery cycles for the product's battery. The manufacturer's limited warranty covers any defects in materials or workmanship under normal use during the warranty period*. For full details, please refer to the Lift Foils website: www.liftfoils.com

GENERAL WARNINGS

 DANGER	 WARNING
<p>FAILURE TO COMPLY WITH THESE WARNINGS MAY RESULT IN SERIOUS BODILY INJURY OR DEATH TO YOU OR OTHERS.</p> <ul style="list-style-type: none"> • Contact with the product's spinning propeller can cause serious injury or death. • Keep your body, fingers, and toes away from the propeller. • Never handle the propeller while the battery is connected to the system. Disconnect the power source before servicing your propeller. • Do not service your propeller in the water. • Do not remove the propeller guard unless in strict compliance with the Operator's Manual's instructions that cover servicing the propeller. • Never operate toward a person in the water. • Do not attempt to open the waterproof hatch compartment while in the water for any reason. • The fin or fins can be and/or become sharp and/or dangerous and can cause serious injuries or death to you and/or others. 	<p>USE OF THIS PRODUCT AND PARTICIPATION IN THE SPORT INVOLVES INHERENT RISKS OF INJURY OR DEATH. BY USING THE PRODUCT, YOU ACCEPT THE INHERENT RISK OF ITS USE. TO REDUCE RISKS:</p> <ul style="list-style-type: none"> • Fully read and follow the Operator's Manual before use. • Always inspect the product prior to use to ensure it is undamaged, that the battery hatch seals tightly, that the controller is in proper working order, and that the product is otherwise fit for use. NEVER use a damaged product. • Stay under control during use. Do not ride at speeds in excess of your ability. Beginners should use extra caution; too slow is better than too fast. • Use only on water. • Only depress the throttle trigger lever when you are mounted on the product and ready to deliver power to the motor. • During use, the hydrofoil is submerged up to 3 feet in depth. Do not use in shallow water or near shore, docks, pilings, swimmers, or other vessels on the water. • Use only in areas that are free of debris and/or abundant wildlife. • Only proficient swimmers should use the product. The rider must stay close enough to shore to swim back in case the product ceases to function. • Always wear appropriate safety equipment during operation, including Coast Guard approved retention devices, a full-faced helmet, a padded wetsuit, and a Coast Guard approved impact vest. Avoid loose clothing that could become wrapped in the propeller. • Never operate while under the influence of drugs or alcohol. • Reduce speed before attempting sudden or sharp turns and maintain safe speeds for water conditions and environment at all times. Maneuverability at high speeds is limited, and sudden turns may cause loss of control. • Keep proper lookout and safe distance for the conditions at all times to avoid collisions. • Obey all applicable navigation rules, boating laws, local regulations and orders. • The product can potentially attract predatory fish. Know your environment and avoid areas where dangerous wildlife exists. • Do not allow others to operate the craft without making them fully aware of the proper procedures and dangers of the craft. • Not for use by children. The product is a powerful water device and should not be operated by anyone under the age of 16.
	 

RIDE SAFETY

TO REDUCE RISKS:

- Always inspect the product prior to use to ensure it is undamaged, that the battery hatch seals tightly, that the controller is in proper working order, and that the product is otherwise fit for use.

 **NEVER USE A DAMAGED PRODUCT.**

- Do not allow others to operate the craft without making them fully aware of the proper procedures and risks of the craft.

-  **NOT FOR USE BY CHILDREN.** This product is a powerful water device and should not be operated by anyone under the age of 16.

PROPULSION SYSTEM

 **DANGER**

CONTACT WITH THE PRODUCT'S SPINNING PROPELLER CAN CAUSE SERIOUS INJURY OR DEATH:

- Keep your body, fingers, and toes away from the propeller
- Never handle the propeller while the battery is connected to the system
- Do not service your propeller in the water
- Do not remove the propeller guard
- Do not have controller turned on while board is out of the water



-  ALWAYS KEEP THE REMOTE OFF WHEN BATTERY IS INSTALLED AND ACTIVE, UNTIL READY TO USE.

-  CONTACT WITH THE PRODUCT'S SPINNING PROPELLER WILL CAUSE SERIOUS INJURY OR DEATH.

-  KEEP BODY, FINGERS, AND TOES COMPLETELY AWAY FROM THE PROPELLER.













-  NEVER HANDLE THE PROPELLER WHILE THE BATTERY IS CONNECTED TO THE LIFT EFOIL.
Disconnect the power source before servicing the propeller.
Do not service the propeller in the water.

-  NEVER OPERATE TOWARD A PERSON IN THE WATER!

BATTERY



DO NOT ATTEMPT TO OPEN THE WATERPROOF HATCH COMPARTMENT WHILE IN THE WATER FOR ANY REASON.

-  DO NOT disassemble or attempt to modify or service. No serviceable parts inside.
-  DO NOT use for any purpose other than that intended.
-  DO NOT mishandle, drop, or damage in any way.
-  DO NOT puncture the battery.
-  DO NOT expose the battery to fire or elevated temperatures (>60 deg C).
-  Inspect the battery before every use. If damaged, do not use. Exposure of a damaged pack to water could result in shock, fire, arc flash, serious injury, or death.
-  Transport this unit in accordance with all applicable laws.
-  DO NOT dispose of this unit. Recycling or disposal of lithium-ion batteries requires specialized facilities.
-  Only charge using the unit provided.
-  DO NOT leave the battery unattended while charging.
-  DO NOT handle the battery and electronics with wet hands.
-  DO NOT drop the battery. Do not use the product's battery if it is damaged. Damage to the battery may result in a fire.
-  DO NOT connect the battery or any electronics while in the water. Assemble all items on the shore in a dry environment.

LIFT BATTERY SAFETY

Our advanced lithium-ion battery has been carefully designed, tried, and tested to resist water and adequate eFoil usage. **In any case the battery seal is compromised, the battery might come into contact with water, which may result in internal damage, fire, or explosion. In case of damage please store your battery in a safe and non-flammable place and contact us right away.**

WARNING SIGNS FOR A COMPROMISED PIECE

- Any visible signs that would indicate the battery's enclosure has been compromised.
- Cracks, seam of the lid not closing down with the rest of the case.
- The battery experienced significant drop or shock.
- The battery becomes irregularly "hot" to the touch.
- The battery is at a significant level of charge (greater than 40%) and suddenly cuts out during a ride.
- Upon inspection, there are no LEDs on the battery, and it is unresponsive.

SAFE BATTERY USAGE

- Use the battery at your own risk.
- Do not open the hatch compartment under any circumstance when in the water or with wet hands. **ALWAYS KEEP THE BATTERY DRY.**
- Never use a damaged battery or a battery that has a compromised seal or that has experienced a significant drop or shock.
- Inspect the battery before each use.
- Do not charge your battery unattended.

- In case of visible damage to the battery seal or water ingress into the battery, remove the battery to a large and open, non flammable area or completely submerge the battery in a tank of water and contact Lift immediately for assistance.
- DO NOT use the battery in temperatures lower than 0°C or higher than 40°C.
- DO NOT drop the battery or use a battery that has been involved in a crash.
- DO NOT place heavy objects on the battery or charger.
- DO NOT walk or stand on your battery.
- DO NOT use a battery different than the lithium-ion Lift Foils battery. If damage results from a non-Lift Foils battery, this will not be covered under the warranty.
- DO NOT disassemble the battery.
- KEEP BATTERY AWAY from heat sources, microwaves, freezers, or pressurized containers.
- IN CASE OF FIRE, extinguish with cold water without additives or dry powder in large amounts.
- DO NOT dispose of batteries in regular trash containers. Follow local regulations for the disposal and recycling of batteries.

GETTING TO KNOW THE LIFT eFOIL

A video containing a full breakdown of unboxing, setting up, and maintaining your eFoil can be found on our YouTube page, titled: [LIFT3 eFoil Unboxing and Setup](#).

HOW THE LIFT eFOIL ARRIVES

THE COMPONENTS FOR THE LIFT EFOIL ARRIVE IN THREE SEPARATE BOXES:

Board & Wing Box
Board, Board Bag, Wing, and Wing Bag



Propulsion Box

Propulsion Unit - Mast, Motor, and Propeller
Propulsion Case
Battery Charger
Charger AC Cable
Hand Controller
Tool Kit
LIFT Sticker

Battery

IN THE TOOLKIT:



- 1 Spare Hatch Seal Tape**
Change when your existing hatch seal shows signs of wear.
- 2 One Ounce Bottle of ReelX**
Anti-corrosion oil to be used periodically on your data connectors, phase pins, and inside of the battery cam-lock.
- 3 Hex Keys, Qty: 2**
 - 4mm (for M6 screws)
 - 5mm (for M8 screws)
- 4 Water Tubing Retainer Kit**
 - Used to reattach the water tubing to the inside of the hatch compartment
 - Kit contains a retainer clip, washer, and screw
- 5 M6x30mm Screws, Qty: 3**
 - Used to connect the front wing to the mast
 - One spare screw is provided
- 6 M6x22mm Screws, Qty: 3**
 - Used to connect the back wing to the front wing
 - One spare screw is provided
- 7 M8x16mm Screws, Qty: 5**
 - Used to connect the mast to the board
 - One spare screw is provided

COMPONENTS

1. BOARD

The board comes in four sizes:



4'2" Pro

4'9" Sport

5'4" Cruiser

5'9" Explorer

SERIAL NUMBERS

- The HIN number of the Lift eFoil is located on the starboard side of the board near the tail. Please verify that your documents match the board's HIN number.
- The serial number of the eBox is located under the white phase connectors.
- The battery serial number is located near the battery handle.
- A white manilla envelope containing all of the paperwork to register your board is included with your eFoil.

Disclaimer: As your Lift eFoil is a powered VESSEL, we recommend all boards to be registered properly according to your local rules and regulations.

2. HATCH COMPARTMENT

The hatch compartment is found on the top of your board and can be accessed by opening its two latches found on the deck pad. The components of the hatch compartment include:

- eBox
- Battery
- Battery Lock
- Bluetooth Antenna
- Data Cables

 **DO NOT** open your hatch compartment over 90 degrees.



3. eBox

The eBox comes installed in the hatch compartment of your board. The eBox components you need to be familiar with are:

- Power button
- Two blue water tubes (input and output)
- Three phase connector ports, each with a colored dot (one red, one yellow, and one green)
- Pairing/firmware relay switch

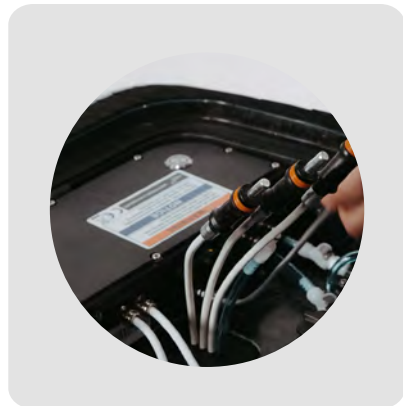

4. BATTERY

The components on the battery include:

- LED Indicators (LED1 - LED8)
- Data Connector Port
- Main Power Connector Port (Cam-lock)



LED Indicators:

The LEDs with **BLINK GREEN** when inactive, with the number of LEDs indicating the state of charge:

- All Lights = 100% Charge
- No Lights = <10%

The LEDs will be **SOLID GREEN** when charging (with the number of LEDs indicating the state of charge while charging). The LEDs turn **BLUE** when running systems checks and when connected to the eBox.

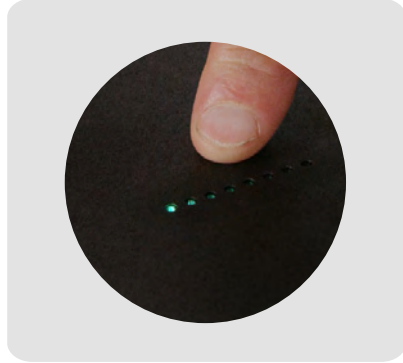

	Full Range Battery	Light Battery
Battery Cell Form Factor	18650 Cylindrical	18650 Cylindrical
Cell Count	196 Cells	126 Cells
Battery Pack Configuration	14S-14P	14S-9P
Nominal Battery Voltage	50V	50V
Battery Voltage Range	35-58V	35-58V
Energy Capacity	2.1 kWh	1.4 kWh
Battery Pack Weight	12.5 kg (27.5 lbs.)	9.3 kg (20.5 lbs.)
Ingress Rating	IP68	IP68
Pack-level Safety	Integrated Contactor Pack Level Fuse Integrated BMS	Integrated Contactor Pack Level Fuse Integrated BMS
Pack-level Safety	Individual Cell FusibleLinks Cell Group Temp. Sensing Cell Balancing	Individual Cell FusibleLinks Cell Group Temp. Sensing Cell Balancing
Operating Temp. Range	0 to 45°C*	0 to 45°C*
Charging Temp. Range	10 to 45°C*	10 to 45°C*
Storage Temp. Range	5 to 25°C	5 to 25°C

* If the battery is too warm (> 45°C), it will charge more slowly until it cools down

5. DATA CONNECTORS

The eFoil utilizes two unique data connectors.

Data Cable - The data cable sends sensitive communication from the battery to the eBox.



Charger Cable - The charging data cable connects the battery to the charger.

Both cables are easily interchangeable. The cables can be damaged by corrosion if not properly maintained. Use your provided ReelX oil to prevent corrosion.



6. PROPULSION UNIT

The propulsion unit is comprised of a carbon fiber mast (28" or 32" in length), the motor, and the propeller. The connectors extending out of the top of the mast are:

- Three phase connectors (one marked red, another yellow, and another green)
- One blue water cooling tube

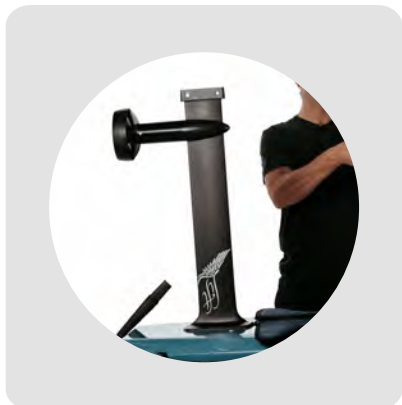

7. MOTOR

Lift eFoils use a brushless inrunner electric motor. The motor maximum power output at shaft is 3,900 watts.

The motor comes preinstalled onto the mast and is removable for service and/or replacement.

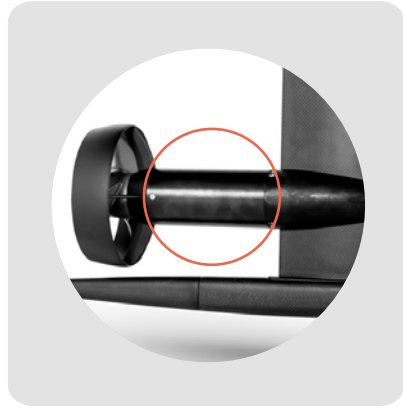

8. WINGS

The wings are critical for the stability of the eFoil. The wings attach to the mast, and the shape of each wing changes the eFoil riding experience, to offer a wide range of options for effectiveness, stability, and performance, and with no unnecessary drag.

Our wings encompass a two-piece construction, with interchangeable front and back wings for easy transport and multiple configurations.

The wing selection is based on the rider's weight, riding style, experience level, and riding conditions. You can find Lift's complete wing lineup on our website: www.liftfoils.com

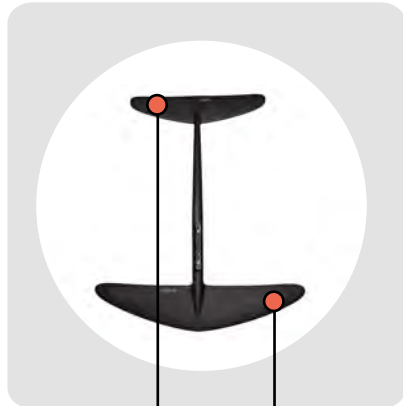

Back Wing

Front Wing

9. HAND CONTROLLER

The hand controller comes with two replaceable AA batteries that will last for 40+ hours of ride time. Use a 2mm hex key to remove the remote's end cap for battery replacement.

NOTE: Always use brand new batteries when replacing the batteries of your hand controller.

Power Button

The power button is above the screen. Click to turn the controller **ON** and **OFF**.

Home Screen

This is the hand controller's display.

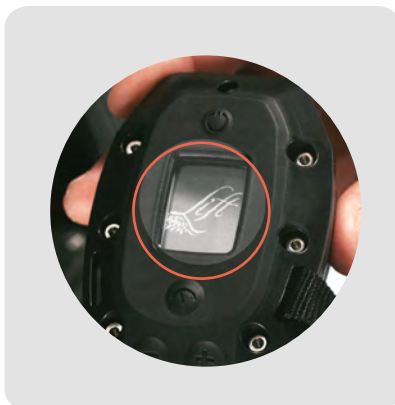
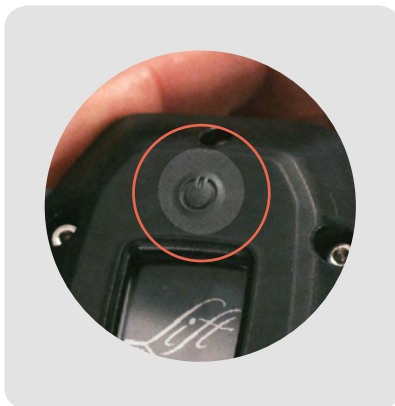

Governor "Set" Button

The Governor button is found under the screen.

Pressing this button will toggle the screen between the remaining battery charge and the speed setting (1-15).



CHARGING THE BATTERY

Identify the main power connector port on the battery



Identify the data connector port and remove cap



Always lay the battery flat and handle it with care. Arrange the battery and the charger to face each other (male & female) to allow for an easier connection.

Battery/Charger Connection Sequence:

Be sure to follow this connection sequence when connecting the battery to the charger and power source.

1. Connect the charging data cable from the charger to the battery.

2. Connect the cam-lock connector from the charger to the battery.
- Apply forward pressure into the battery and rotate the cam-lock clockwise.

⚠ CAUTION: Be careful not to force the connection, which can damage the power connector panel of the battery.

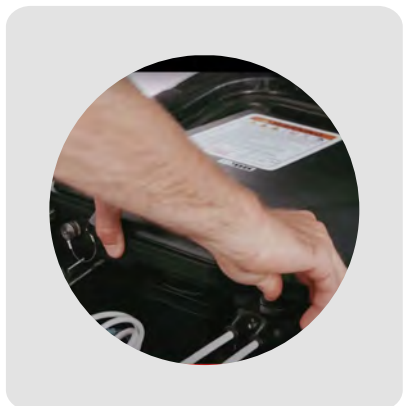

3. Plug the battery charger into a wall outlet.

- Plug the battery charger into a wall outlet AFTER both the main power (cam-lock) connector and charging data cable have been connected.

- **NOTE:** This is a high-energy charger and should not share a power receptacle with other appliances. Make sure that the power source for charging can handle up to 1200 watts.

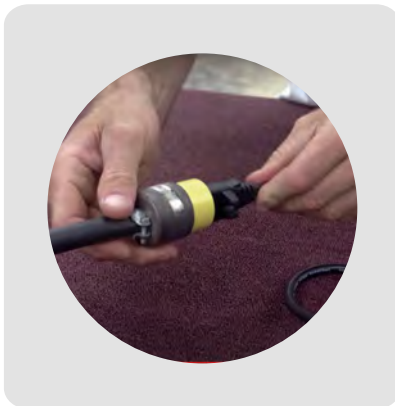

NOTE: Following the correct connection sequence is critical.

Connecting or disconnecting plugs or cables in the wrong order may cause arcing and premature wear of your equipment.

⚠ CAUTION: Be very careful with the data pins of the charging cable and ensure that they remain free of damage and corrosion. **Take care of your data connectors as necessary to maintain a clear connector. Rinse with fresh water and apply ReelX.**

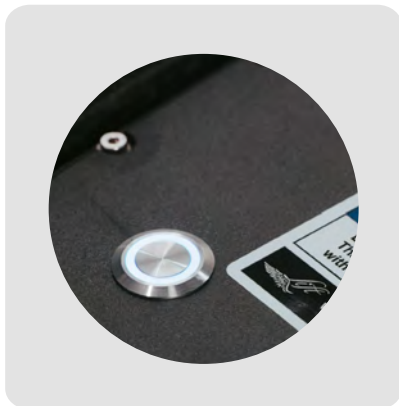

The battery and charger will make an audible clicking noise when the connection has been made.

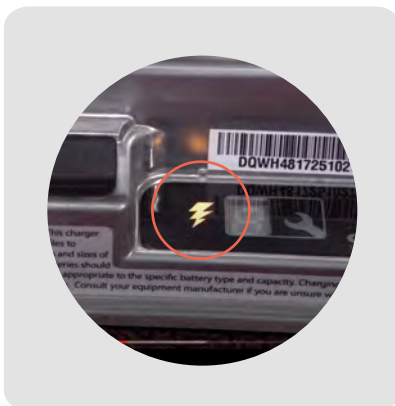

The lightning bolt icon on the charger indicates that charging has started.

The green LEDs on the battery will indicate the charging progress. For example, 4 green LEDs indicate the battery is roughly 50% charged.

- Charging is recommended in a cool and dry environment.

- Do not cover up the charger while in use. The aluminum heat sinks are designed to allow airflow and cooling of the charger.

- The charger fan will come on automatically if and when necessary. It's OK if the fan does not turn on while charging.

- The battery is fully charged when the lightning bolt icon (on the charger) turns off, and all 8 LED lights (on the battery) are BLINKING GREEN. Charging should take up to 2 hours.

NOTE: It is not necessary to fully discharge the battery before putting it to charge.

DISCONNECTING THE BATTERY

When charging is complete, all 8 LEDs will BLINK GREEN. Once the battery is fully charged, follow this disconnection sequence:

- First, unplug the charger from the wall outlet.
- Next, disconnect the charging data cable from the battery.
- Finally, disconnect the power connector cam-lock from the battery connector.

To stop charge mid-way, disconnect the charging data cable and wait for charging to stop. Next, disconnect the charger from the wall, then disconnect the cam-lock connector.

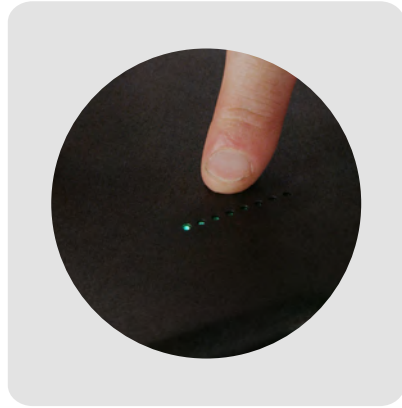

ASSEMBLY

While the battery is charging, find a clean environment to assemble the rest of the eFoil.

INSTALLING THE MAST

1. Locate the mast and the board.

The top of the mast has a rubber seal on the surface with three phase connectors and one blue water tube with connector.

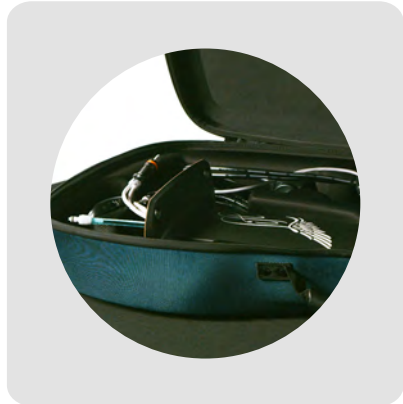

2. Locate the four threaded inserts on the bottom of the board. This is where the mast will connect.

Steady the mast and feed the cables through the port at the bottom of the board.

PRO TIP: Arrange the cables so there is a nice smooth curve, guiding the tips of the cables toward the front of the board.

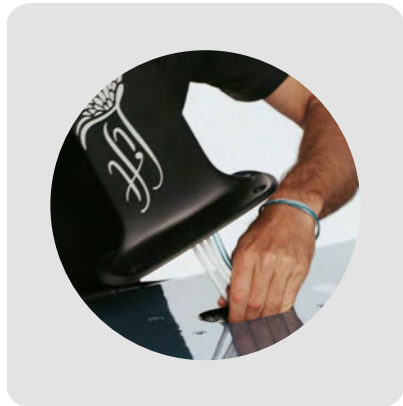

3. Use both hands to secure the mast and press down firmly as the rubber seal seats into position.

While holding the mast in place with one hand, find the M8x16mm screws and start threading them in by hand.

Make sure all four M8 screws are threaded by hand before tightening with the 5mm hex key. Continue to hold the mast in place and tighten the screws with the 5mm hex key.

Tighten the M8 screws firmly and cycle through each one at least twice to ensure a secure connection and seal. Be sure that all edges of the mast base are seated firmly against the bottom of the board.

INSTALLING THE WINGS

The front and back wings are shipped unattached, so you will first need to attach the front wing to the back wing, for a completed wing set-up.

Remove the front wing from the wing bag. Locate the back wing, wrapped separately in the board box. Attach the front wing to the back wing using two M6x22mm screws and the 4mm hex tool.

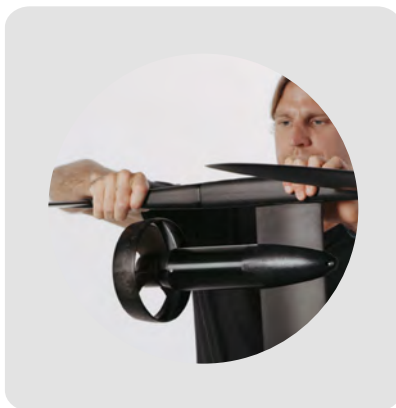

Install the wing set-up onto the mast using two M6x30mm screws and the 4mm hex tool.

Place the assembled wing set-up into the wing bag, for protection while continuing assembly.

Once the mast and the wings are securely installed, flip the board over and open the hatch.

CONNECTING THE ELECTRONICS

1. Open the hatch compartment by identifying the two latches on the board pad. Lightly press down on the top of the hatch, while lifting the latches and rotating to open.

Make sure not to overextend the hatch compartment when opening.

 DO NOT open your hatch compartment over 90 degrees.

2. Connect the three phase connectors to the eBox and both ends of the water cooling tube.

NOTE: There is a distinct feeling and sound when the blue water cables connect. This is critical to keep the eBox running cool. Water will not flow if the connectors are not properly mated.

Insert the phase connectors by matching the colors (red, yellow, and green) and pressing firmly.

NOTE: Plug red, green, and yellow phase connectors into the corresponding connection points. If a cable is put in the wrong port, the propeller will spin in reverse but will not damage the motor.

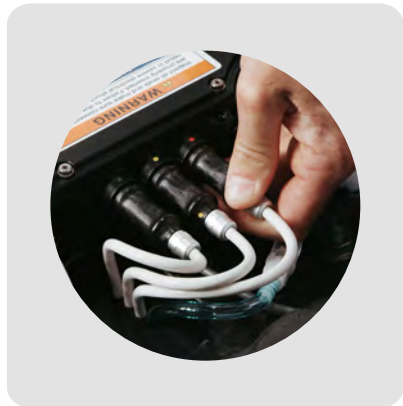

3. Apply a drop of ReelX to the phase connector electrical contacts and data plug.

The connection points are double-sealed for water protection, so there might be slight resistance which guarantees a waterproof seal. Ensure that the orange o-ring is fully inserted.

⚠ CAUTION: If the phase connectors are not fully seated into the eBox and water enters the hatch compartment, it may result in an electrical shock.

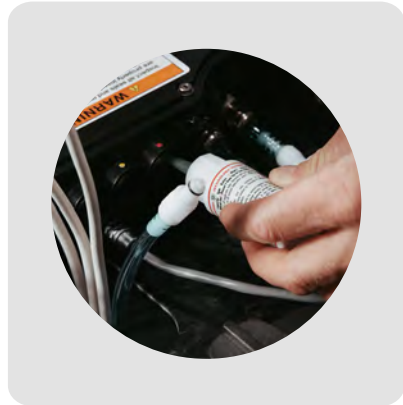

GETTING READY TO RIDE

INSTALLING THE BATTERY

1. Open the hatch compartment in a clean area free from water or sand and place the fully charged battery inside with the stickers facing up.

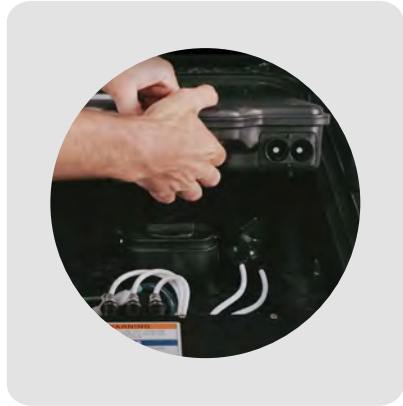

- Secure the battery using the battery cam-lock.

- Make sure the eBox is turned off by viewing the POWER BUTTON button on the left-hand side of the eBox. The POWER BUTTON will be a solid blue ring when **ON** and colorless when **OFF**.

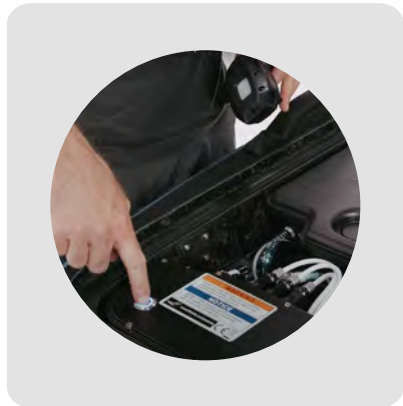

2. Connect the power connector with the battery by sliding the cam lock slip over the pin; apply forward pressure and twist the cam-lock connector 90 degrees to engage.

⚠ CAUTION: Remember, do not force the cam-lock onto the battery connector panel because this damage the battery connector panel.

NOTE: Apply a drop of ReelX to the contacts inside the power connector and data cable once a month. Check your data cable's plug and battery receptacle for signs of corrosion. Clean it with an electrical contact cleaner spray if needed and once dry, apply a drop of Reel X.



3. Remove the protective cover from the data port on the battery and carefully plug in the data cable. Make sure to feel and hear the data connector "click" into place. The data connector is keyed, so it only will connect with the red dots are lined up.

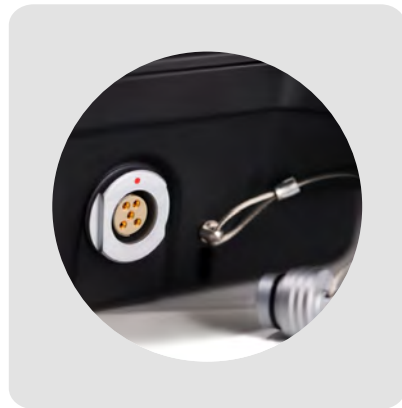

⚠ CAUTION: This data cable uses sensitive electrical contacts to relay critical information to the electronics box. It is important to keep this connector and its pins clean and free of debris and salt water.

TAKE CARE OF THE DATA CONNECTOR!

BOOTING UP THE SYSTEM

1. Press the power button on the eBox one more time to boot up the system. The power button will flash blue as it goes through its system check. It will turn solid blue when the startup is complete. The battery light bar will also show four blue LEDs indicating that the connection to the system is successful.

- There will be an audible “click” inside the battery as the battery turns on. This is the internal battery contact closing the circuit and applying voltage to the system.

- After a few seconds, there will be a chime from the motor confirming the startup sequence of the motor.

NOTE: The startup procedure can take up to 10 seconds for a comprehensive system check.

Lights on the battery will turn from green to blue as it enters “startup” mode.

NOTE: It is important to become familiar with this startup sequence as it is how you’ll know the Lift eFoil is ready to ride.



2. Power on the hand controller by pressing the power button above the screen. The Lift logo will appear, followed by a battery icon, which will appear on the hand controller's screen. This confirms that the hand controller and board are properly paired.

NOTE: If the hand controller screen indicates "no signal," the board and hand controller are disconnected. Please review the **PAIRING THE CONTROLLER** section on p. 38.

3. Once pairing has been confirmed, make sure the propeller is free and clear, and give the controller a small amount of throttle to spin the propeller.

NOTE: The propeller should be rotating counterclockwise when facing the front of the board. If it is not, check the phase connector plugs to make sure the colors match.

4. Once the propeller is confirmed to be spinning counterclockwise, press the power button on the hand controller to turn it off.

 **CAUTION: DO NOT** transport the board with the hand controller turned on. Always turn off the hand controller in any instance when you're NOT riding the eFoil.

 **CAUTION: DO NOT** run the motor out of the water except for a brief check to ensure it is working correctly.

5. Finally, inspect the hatch compartment seals to ensure that it is free from damage and debris. Carefully close the lid and fasten the latches.

6. Ensure the hatch compartment is sealed. You should not experience large quantities of water in the hatch compartment after a ride.

PAIRING THE CONTROLLER

PAIRING HAND CONTROLLER VIA BLUETOOTH

If the screen on the hand controller is indicating “no signal,” the hand controller is not paired with the board or the board is turned off.

To pair the hand controller:

1. Confirm the eBox is turned on.
2. Confirm the hand controller is turned off.
3. Press and hold the (-) and (+) buttons, and then press the power button on the hand controller.
4. The hand controller screen will show a Bluetooth logo, indicating that it is in pairing mode. If this screen does not appear, turn off the hand controller and repeat the above process to enter pairing mode.

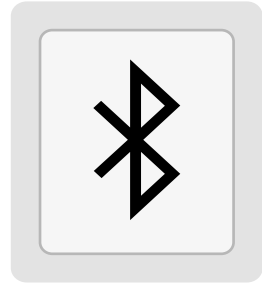

5. After the controller is in pairing mode, press and hold the black relay button on the eBox (located near the blue water tubing) for up to 5 seconds. The blue startup button will flash and the hand controller will display a check mark, indicating the hand controller is now paired to the eFoil.

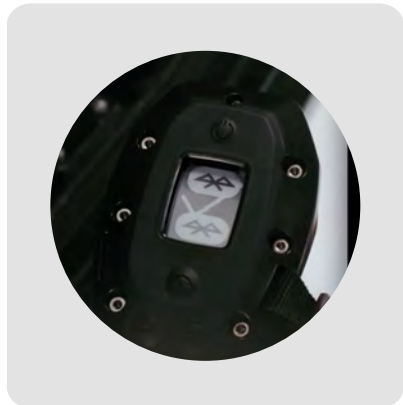
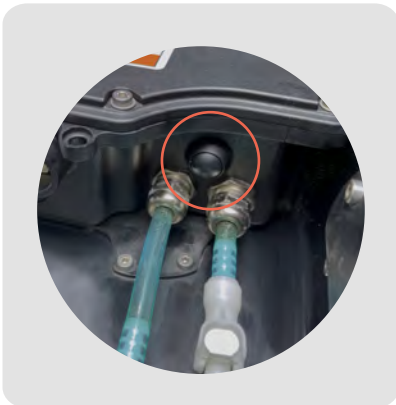

CONTROLLER HOME SCREEN

- The hand controller's home screen displays the battery level of the main battery inside the board, indicating how much ride is remaining.

⚠ CAUTION: The Lift eFoil will automatically reduce power and enter into a "limp mode" when there is only 10% battery left. **This indicates you need to return to shore and recharge the battery.**



Be aware of the screen for low battery and other warnings or your hand controller will alert you if it is low on battery or if your electronic components are getting irregularly hot.

GOVERNOR MODE

- Governor mode limits the maximum throttle output, which allows riding at reduced speeds.
- Press the (+) or (-) button to increase or decrease your power level from 15 total settings.
- To set your power level, make sure the hand controller is powered on and then press the "set" button just below the screen. Press "set" again to lock in the governor setting. Your power level will be displayed on this screen.

RIDING THE eFOIL

PLEASE WATCH OUR INSTRUCTIONAL VIDEOS TO LEARN HOW TO RIDE.
FIND OUR INSTRUCTIONAL VIDEOS ON OUR YOUTUBE CHANNEL AT:
www.youtube.com/liftfoils

REMEMBER: ALWAYS RIDE SAFELY AND RESPECTFULLY.

Inspect the areas where you will ride. Bear in mind that you will need a minimum of 4 feet of water depth. Watch for submerged obstacles, such as rocks or roots. Hitting submerged objects can cause injury to riders at any speed. Always make sure the hand controller is off when carrying the Lift eFoil. Make sure to establish a comfortable method for carrying the eFoil or get help from a friend. Get accustomed to the trigger and the power settings.

WARNING: Do not squeeze the trigger fully or quickly.

Beginners should use the governor feature in the hand controller. Select governor setting one and start learning the basics and getting comfortable handling the eFoil.

LEARNING PROGRESSION

- Make sure to use protective equipment such as helmet and life jacket.
- Begin with one hand holding the controller and the other hand holding the board's nose. Remember, keep the nose out of the water, begin applying the throttle by pressing the trigger, and lean forward.
- Start in the prone position on the board (on your belly), make some turns, and get used to the throttle actuation.

WARNING! Don't put your feet inside the propeller. Always keep all body parts clear from the propeller.

NOTE: At a higher speed—around 10 miles per hour—the board becomes more stable.

- Once you're comfortable in the prone position, transition to the kneeling position. Keep a consistent throttle and make a few turns and get comfortable.

- Maintain consistent throttle and slowly transition from kneeling to standing.
- Adopt a wide stance square with the front of the board for additional stability. It's critical to shift your weight forward as the board accelerates. This is true for any riding position—prone, kneeling, or standing.
- Do not rush eFoiling—this process takes practice and it is important to stay safe.
- While the throttle controls speed, weight distribution controls the elevation of the eFoil.
- Practice doing “touch and go’s” by easing onto the eFoil and shifting weight back while at sufficient speed, then slightly letting off the throttle while shifting weight forward to bring the board back down to the surface of the water.
- Never venture out past what you are not able to swim. Ride with a partner for added safety.
- Bailing is a critical part of learning to foil. There’s a big difference between purposefully bailing out (which puts distance between the rider and the eFoil) and uncontrollably falling, which can lead to injury.
- When losing control of the board, use the last bit of balance to bail out and create distance between yourself and the board.

WARNING: Always bail to the sides or back of the Lift eFoil, NEVER toward the front.

- Always turn off the hand controller while swimming back to the board to avoid pressing the trigger. Once safely back on the board, turn the hand controller back on.
- Always keep all body parts clear from the propeller. If you’re a first-time eFoiler make sure to book a demo session at any of our 300 affiliates worldwide. Find our locations on www.liftfoils.com
- Do not open the hatch compartment when in the water.

THIS PRACTICE TAKES TIME TO MASTER, SO SLOW DOWN, LEARN, HAVE FUN, AND MAKE SURE TO WEAR PROPER SAFETY GEAR SUCH AS GLOVES, HELMET, BOOTIES, COAST GUARD APPROVED VESTS, AND/OR A WHISTLE.

POST RIDE

POWERING DOWN

1. As soon as the ride is over, turn off the hand controller by pressing the top power button.

2. Once the Lift eFoil is completely out of the water and on land, open the hatch and simply push the power button to shut the eFoil off. The power button will go from blue to flashing blue to off.

NOTE: Remember: All of these components are completely waterproof and it's normal for some water to get into the hatch when opening—but it should be less than a cup.

3. Disconnect the data cable from the battery by pulling back on the metal housing.

4. Disconnect the main power connector from the battery by twisting the cam-lock counterclockwise and releasing the connection.

5. Twist the cam holding the battery in place and remove the battery.

eFOIL MAINTENANCE & STORAGE

- Make sure to rinse the outside of the eFoil, especially the motor, with fresh water after each use.

- Flush out the water cooling line by pressing a hose against the inlet located at the propulsion's nose cone.

- If you see salt water, sand, or debris inside the compartment, it's a good idea to rinse it out with fresh water, drain it, and dry it out with a towel.

- If the connectors encounter salt water or debris, clean them out with fresh water and allow them to properly dry.

NOTE: If riding in salt water, rinse the data connector directly with fresh water.

- Use the provided ReelX oil to coat the electrical contacts at least once a month (and more often with frequent use).

NOTE: This will also prevent corrosion.

NOTICE: This oil can be used on the rubber seals to provide lubrication for a smooth connection. It also works well on any metallic surfaces, such as the compression latches and hinges.

- Be sure the inside of the compartment is completely free of moisture before closing the hatch and storing your eFoil.

- When storing your eFoil, make sure to use the provided bags and cases and don't store them in direct sunlight. UV and excessive heat exposure can cause permanent damage.

- Don't leave the hand controller in direct sunlight for an extended amount of time.

THESE STEPS PREVENT DAMAGING CORROSION AND KEEP THE LIFT IN OPTIMAL CONDITION.

The electrical contacts are critical in the eFoil. Scratches, salt water, corrosion, and any other damage to the electrical contacts and connectors can cause rapid degradation and will lead to system failure. The electrical contacts and connectors are of the highest quality but need to be maintained to stay that way. Take care of the electrical connectors.

Being diligent about inspecting your data connectors, regular cleaning and use of ReelX will greatly extend the life and durability of your data connectors!

BATTERY MAINTENANCE

- Before every use, inspect the battery for damage and water ingress. Extra attention should be paid to the enclosure, looking for any cracks in the plastic or areas where the lid may have begun pulling away from the housing (these are potential leak paths). Do not use a battery that has been damaged or you suspect to contain any water.
- While the battery pack is waterproof and totally sealed, minimizing exposure to water is recommended.
- Keep the data cable clean and dry. If any debris or moisture enters the connector, clean with low-pressure air. A gentle freshwater rinse may be used if salt water enters the connector. Oil the connector regularly using the lubricant provided (ReelX), which means every few uses and before storage.
- Keep the cam-lock connector clean and dry. Recommendations provided for the data cable may be followed here as well. While the cam-lock connector is less sensitive than the data cable, avoiding debris, moisture, and salt water ingress will improve the cam-lock's service life.
- NEVER use a high-pressure spray of water on the battery as it will damage the seals.
- NEVER use compressed air on the battery as it will damage the seals.
- NEVER drop the battery.
- NEVER subject the battery to harsh mechanical vibration or shock.
- NEVER operate a battery with any visible damage.
- NEVER attempt to repair a damaged battery.

BATTERY STORAGE

Storing and caring for your eFoil battery during periods of inactivity is simple, but important, so we've prepared this guide below.

Storage

Store your eFoil battery in a cool, dry location. **The ideal storage state is at 30-50% of battery charge.** This will lead to the longest life for your battery. You can identify the level of the battery's charge by the LED lights. A 30-50% battery charge is equivalent to 3-4 BLINKING GREEN LEDs (out of the 8 LEDs).

Allowable Temperature: -30°C to 50°C (-22°F to 122°F)

*Storing a battery in more extreme cold or heat can lead to accelerated aging of the battery.

Ideal Storage Temperature: 5°C to 25°C (41°F to 77°F)

*Keeping the battery stored within this temperature range increases battery longevity.

We recommend storing your lithium-ion battery in a fireproof case. You can buy Zarges Cases on our website: <https://liftfoils.com/product/zarges-case/>

Discharge

As with all lithium-ion batteries, the Lift eFoil battery will slowly lose charge over time while it is stored. **If stored for a long time (roughly 9 months to several years) without use, the battery can become over-discharged and lose the ability to be charged at all.** To prevent this, and to ensure the longest life for your battery, the battery should be plugged into a charger and charged until reaches **30-50%** every **3 months**.

Wake Up

To wake up your battery after a long period of inactivity, follow normal charging instructions; there are no special changes after a long period of inactivity. Remember to first connect the charging data cable, then the cam-lock, and then plug the charger into the wall.

DOWNLOAD THE LIFT QUICKSTART APP _____

The **Lift Quickstart App** is available to download in the Apple App Store & Android Google Play Store.

To ensure the best performance and that your board and hand controller are up to date with the latest software, download the **Lift Quickstart App**.



CONNECT & UPDATE YOUR PRODUCTS

- To connect your board and/or hand controller, simply open the App and navigate to the “My Products” section. There you will find a step by step guide on how to pair the app with your device.
- Once connected, your device may instruct you to update. If so, there is a newer software version available and we recommend you perform the update.

SUBMIT SERVICE TICKETS

- If you are experiencing any issues with your product, follow prompts to submit a service ticket to our customer support team. You can also contact us at help@liftfoils.com
- Our customer support team may ask you to submit photos or videos to better direct them to the proper diagnosis and solution. By providing the necessary information, it will ensure our team can provide quick and detailed responses to address your specific issue.

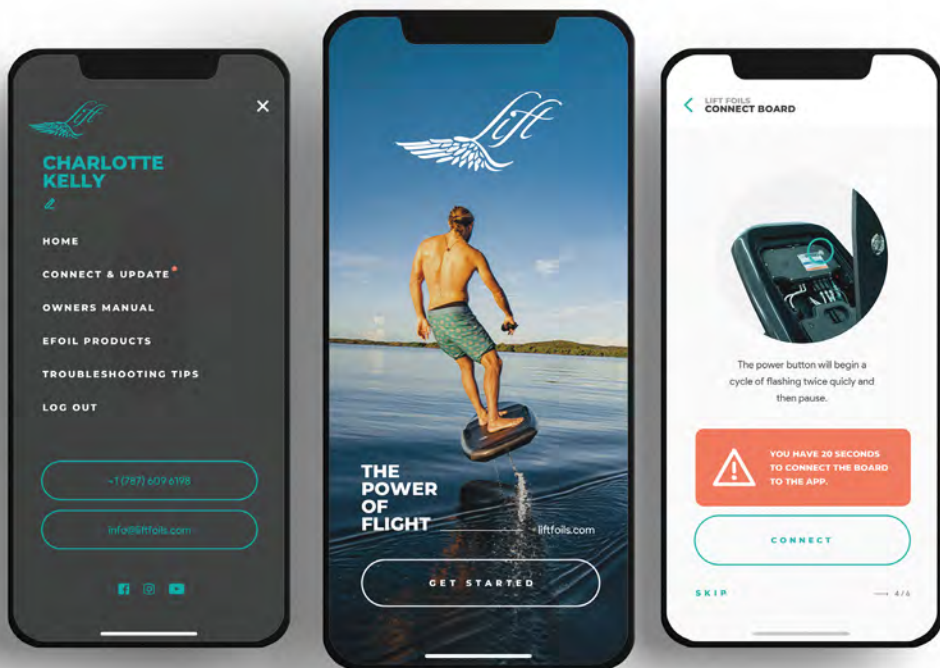

TROUBLESHOOTING _____

What happens if something goes wrong?

- Check the manual, how-to videos, and pro-tip section on [Lift's Youtube channel](#).
- Make sure the eFoil is running the latest firmware.
- Send an email to help@liftfoils.com and schedule an appointment.
- Use our Lift eFoil app to send a service ticket.

Hand controller disconnects while in the water

- Establish a good connection by making sure that the hand controller and the nose of the board aren't submerged underwater.

Excess water inside the hatch compartment

- Inspect your latches, to ensure they are properly tightened. The latches will loosen up over time and use, and may require a minor adjustment. Tighten your latches as shown on our YouTube video "[Maintenance Video: Hatch Compartment](#)" (minute 2:12).
- If the latches are properly tensioned and secure, inspect the gasket seal around the perimeter of the hatch compartment, for tears or damage. This can leak if the seal becomes compressed or flattened over time. We provide extra hatch seal tape in the eFoil's tool kit, in the event it needs to be replaced.

Propeller spinning in reverse

- Check the phase connectors and confirm that the colors match: red to red, yellow to yellow, and green to green.

The battery charger isn't connecting (no lighting bolt)

- It is critical you follow the correct sequence when plugging in the charging and power cables between the battery and battery charger.
- First, connect the charging data cable from the charger to the battery. Next, connect the cam-lock connector from the charger to the battery. Lastly, plug the battery charger into a wall outlet.
- Ensure that all connections are properly mated.

The battery's LEDs are blinking green

- **BLINKING GREEN LED** lights indicates that the battery is inactive. The number of LED lights blinking indicates how much charge is available.
- If no LEDs are blinking, then it means the battery has less than 10% charge, and charging is recommended.

Battery charge during storage

- We recommend storing the battery between a 30 - 50% charge for anything over 4 weeks.
- **It is not recommended to store the battery in a very low state of charge for an extended period of time. The battery can become over-discharged and lose the ability to be charged at all.**

The hand controller isn't connecting to the board

• If the screen on the hand controller is indicating “no signal,” the hand controller isn't paired with the board or the board is turned off. Ensure that the board is on and pair the hand controller to the board by following these steps:

1. Confirm the eBox is turned on.
2. Confirm the hand controller is turned off.
3. Press and hold the (-) and (+) buttons, and then press the power button on the hand controller.
4. The hand controller screen will show a Bluetooth logo, indicating that it is in pairing mode. If this screen does not appear, turn off the hand controller and repeat the above process to enter pairing mode.

The board turns off while riding

• Return to shore ASAP, open compartment, and confirm that the data connector is clean and free of debris and/or corrosion. Check that all connectors are properly mated.

Dropped the battery

 **DO NOT USE THE BATTERY AND CONTACT LIFT.**

Damage to electrical contacts or cables

 **DO NOT USE THE eFOIL AND CONTACT LIFT.**

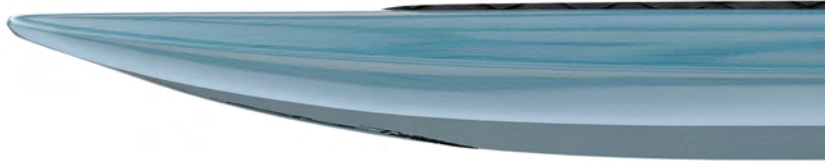

Phone: +1.787.609.6198

info@liftfoils.com

@liftfoils



LIFTFOILS.COM