

Dispositivo de Segurança

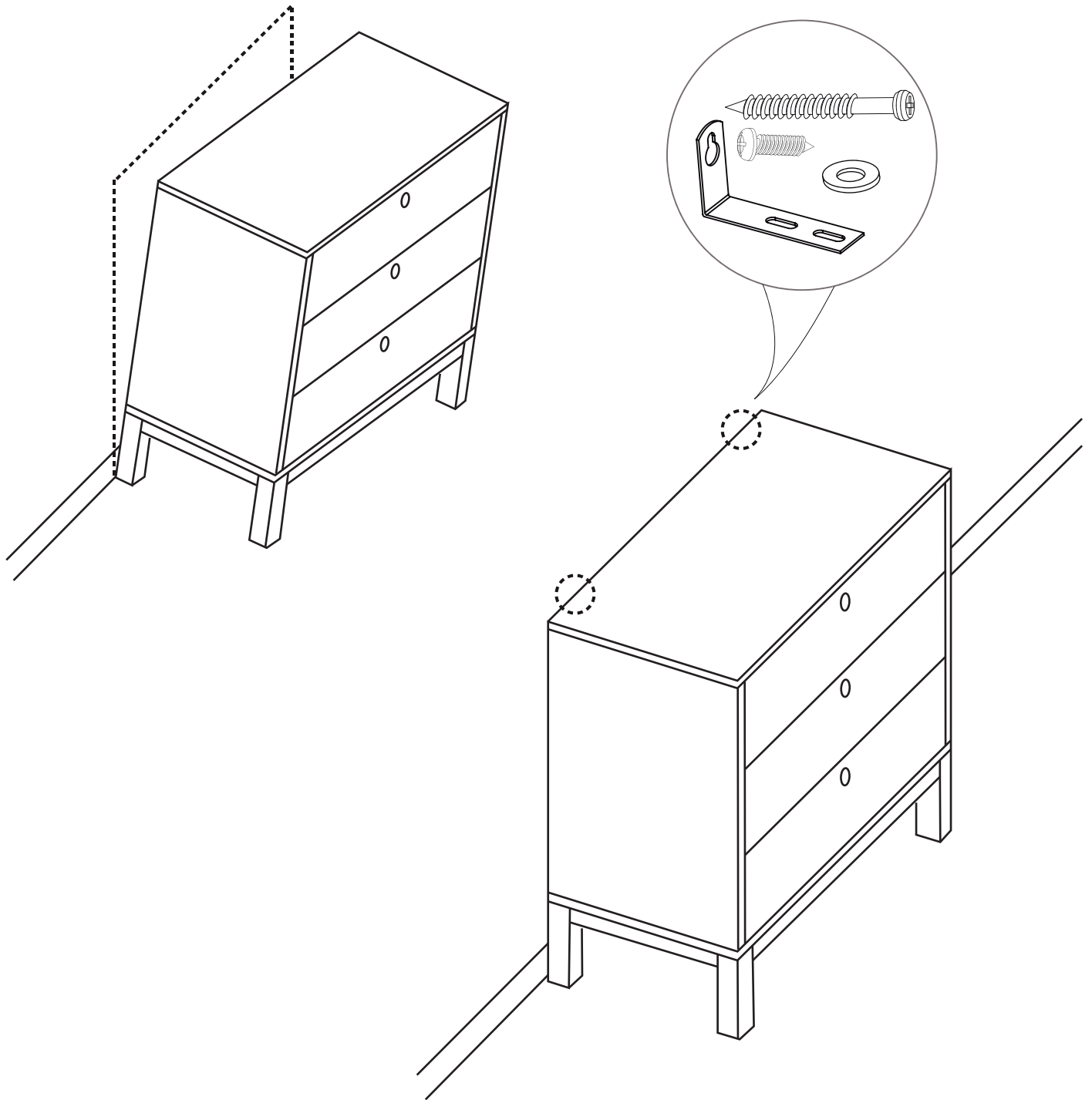

Dispositivo de Segurança

A Vero acredita que um lar deve proteger seus moradores.

Pensando nisso, desenvolvemos um sistema onde o móvel fixa-se na parede, deixando-o seguro.

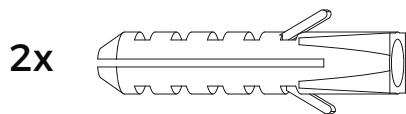

A- Bucha 8

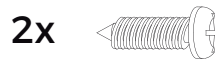

C- Parafuso 4x14

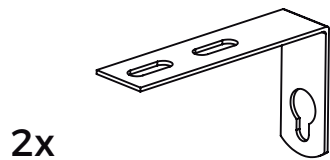

B - Cantoneira



D- Arruela

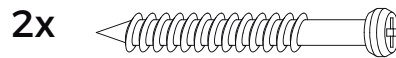

E- Parafuso 5x40

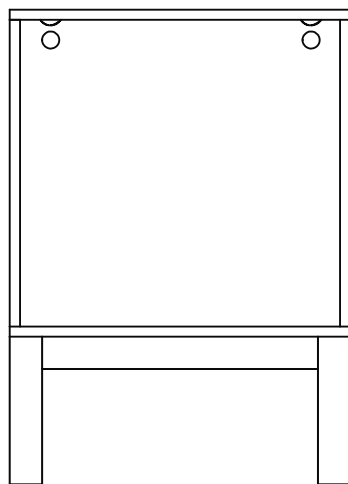

Furo no fundo para ser fixo na parede

01

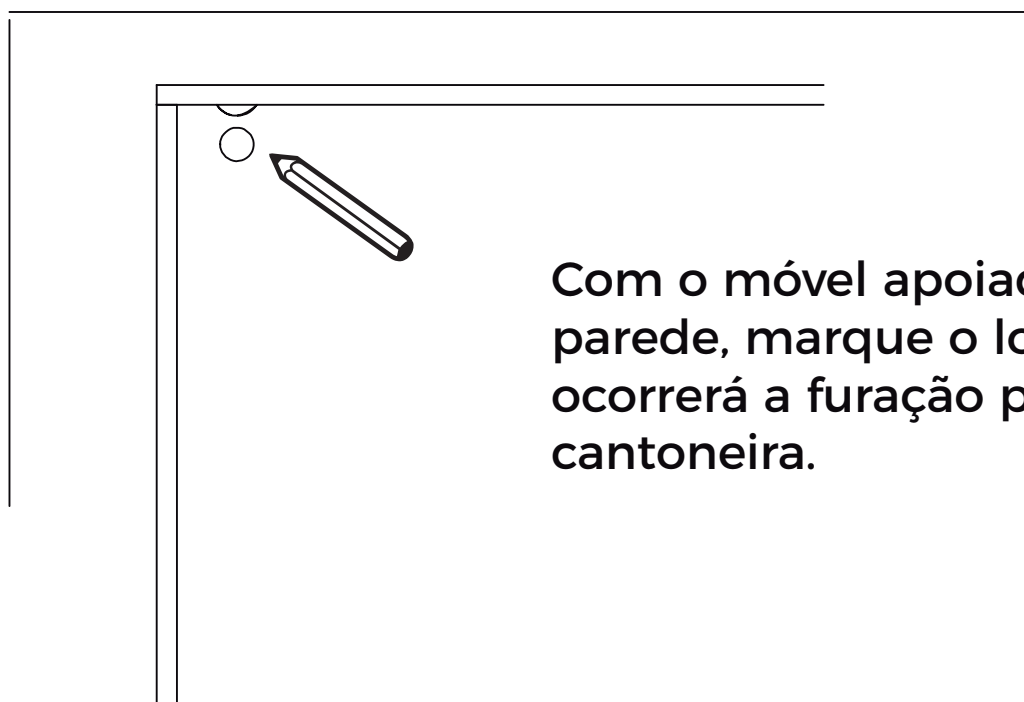

Com o móvel apoiado na parede, marque o local onde ocorrerá a furação para fixar a cantoneira.

02

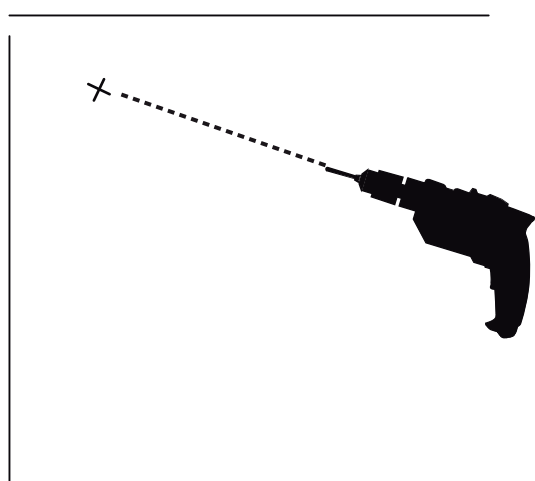

03

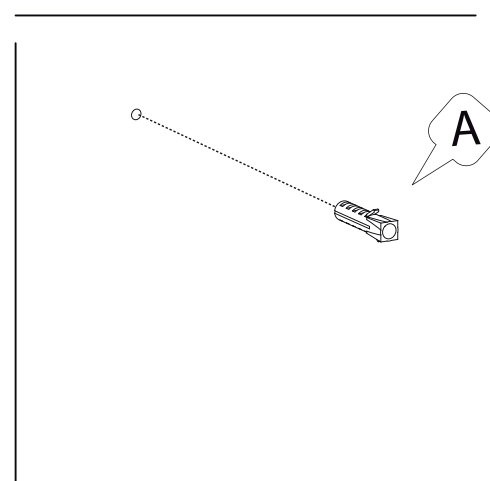

Afaste o móvel e fure a parede

04

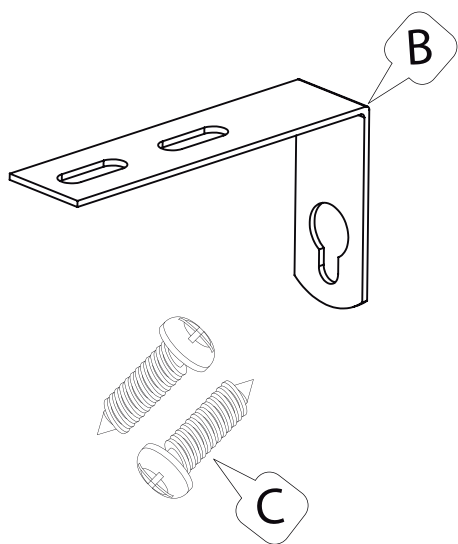

Encaixe a cantoneira de modo que a parte de trás fique para fora do móvel, e a parte da frente fique para dentro do móvel, conforme imagem abaixo

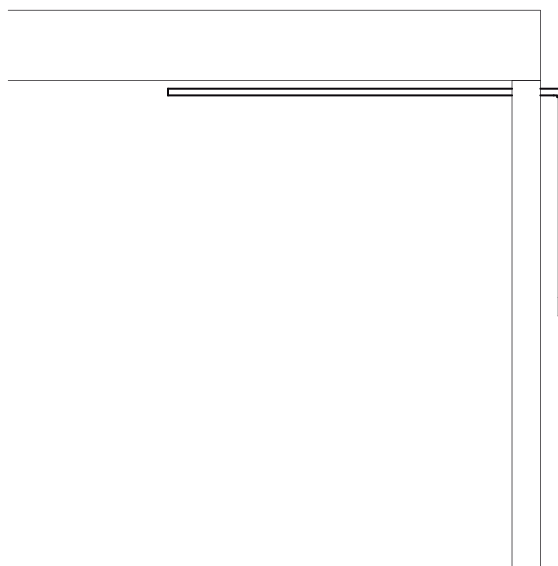

05

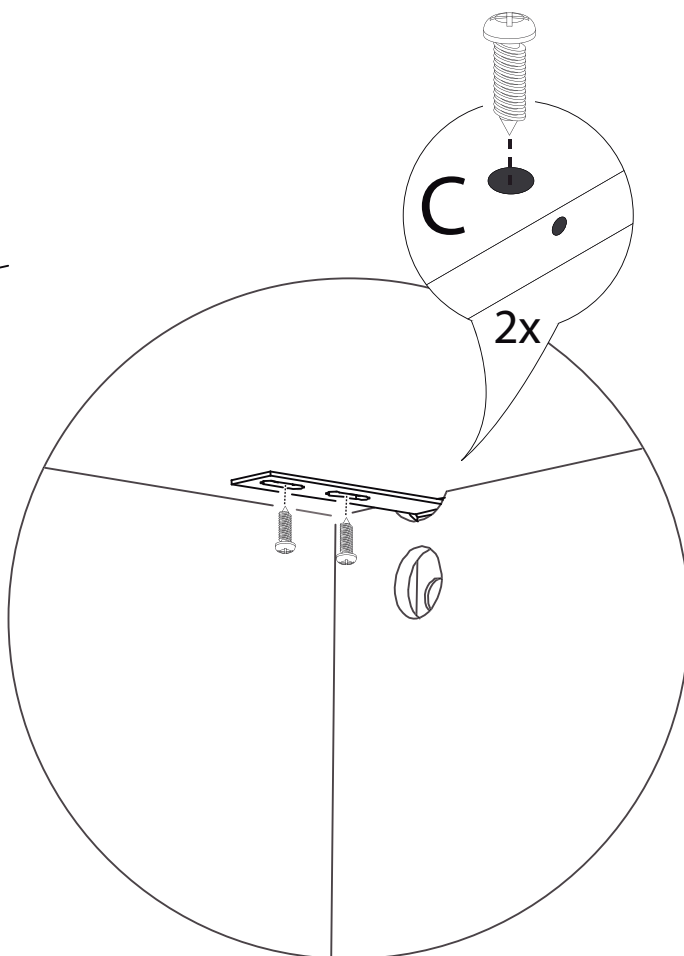
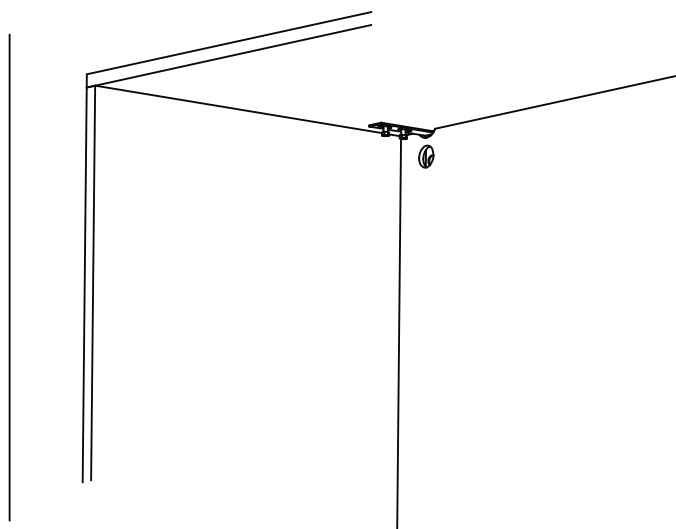

06

Com a cantoneira fixa no tampo do móvel, agora é hora de encaixar a cantoneira na parede.

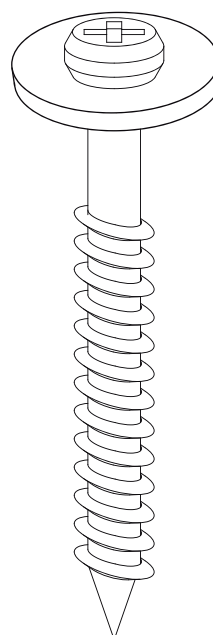
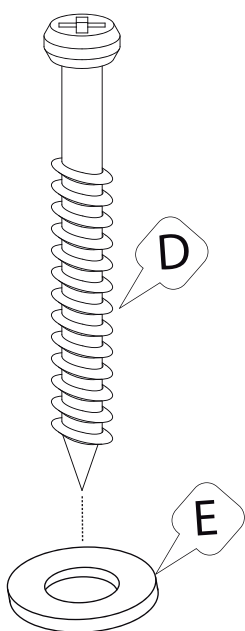

Coloque a arruela no parafuso 5x40

07

Parafuse o parafuso na bucha.
Seu móvel agora está fixo e seguro.

