

Pato

prateleira / estante / *shelf*

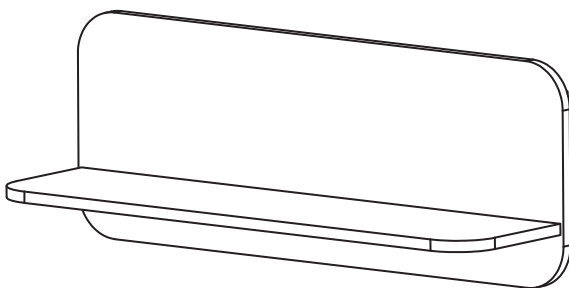

veromobili

feito **com amor** no brasil



Leia atentamente as instruções antes de montar seu novo móvel preferido!

¡Lea atentamente las instrucciones antes de montar su nuevo mueble favorito!

Read the instructions carefully before assembling your new favorite furniture!

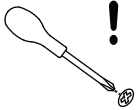

A Veromobili disponibiliza uma chave Philips para vc realizar a montagem com segurança!

La Veromobili te ofrece una llave Philips para que realices el montaje de forma segura.

The Veromobili offers a Philips key for you to carry out the assembly safely!

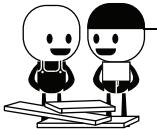

Peça a um amigo para te ajudar nesta montagem. Fica mais fácil e divertido em boa companhia!

Pídale a un amigo que le ayude con esta montaje. ¡Es más fácil y divertido en buena compañía!

Ask a friend to help you with this setup. It is easier and more fun in good company!



Realize a montagem sobre um tapete ou pano para não estragar ou arranhar o acabamento!

¡Realice el montaje sobre una alfombra o paño para evitar dañar o rayar el acabado!

Perform the assembly on a carpet or cloth to not damage or scratch the finish!



Tenha atenção para a posição correta de cada peça. Posiciona-las invertidas pode prejudicar a estabilidade e segurança do seu móvel!

Presta atención a la posición correcta de cada pieza. ¡Colocarlos invertidos puede poner en peligro la estabilidad y seguridad de sus muebles!

Pay attention to the correct position of each piece. Positioning them inverted can jeopardize the stability and security of your furniture!

Conteúdo

Contenido
Content

Peças

Partes
Parts

A. x1

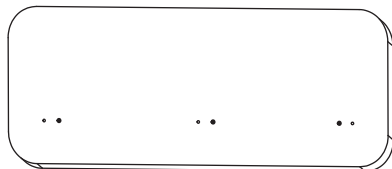

B. x1



C. x2

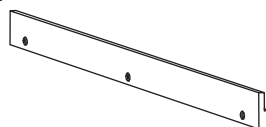

Ferragens

Herrajes
Hardware

1. x6



Parafuso 5,5x65

2. x3



Parafuso 5x40

3. x6

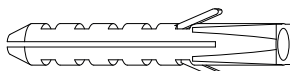

Bucha 8mm

4. x3



Cavilha

5. x1

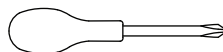

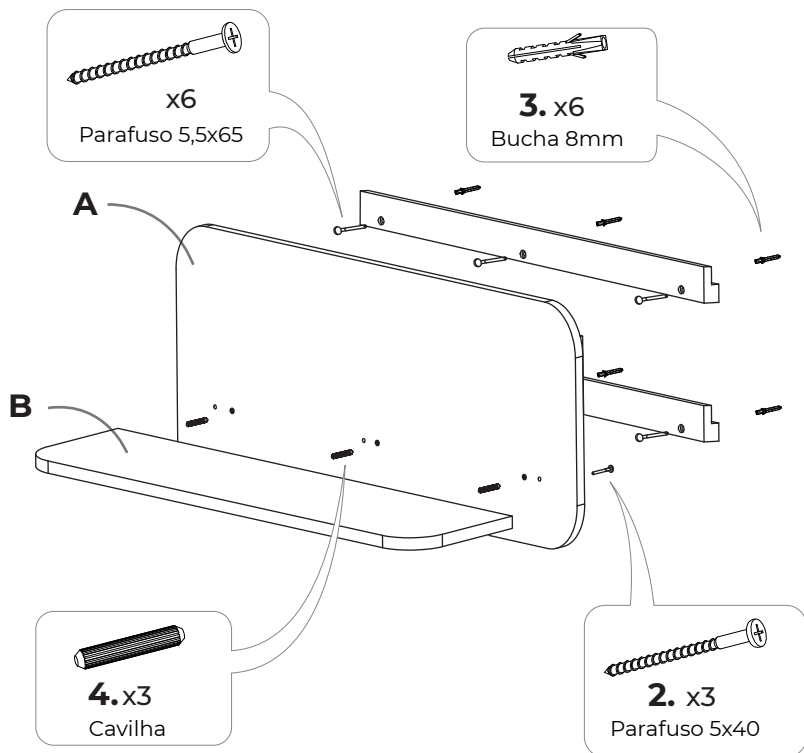

I.

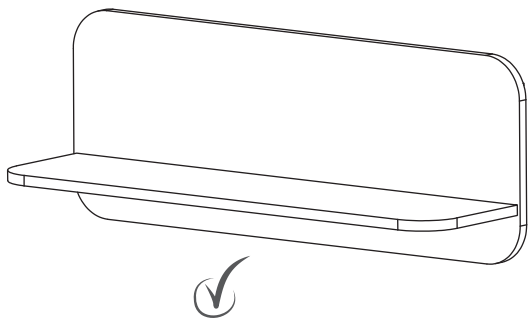
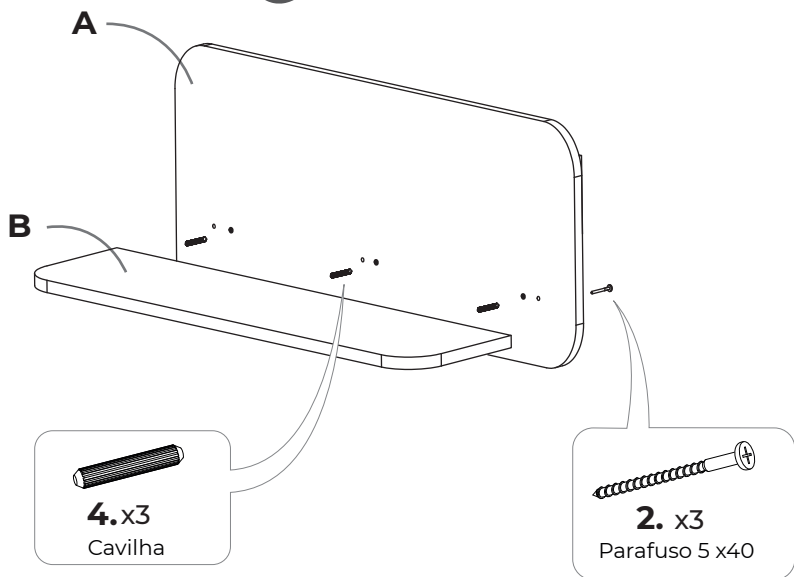
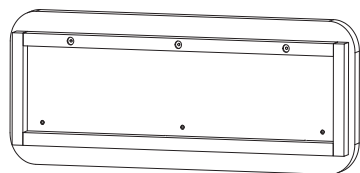

II.



Marque a parede com um lápis e fure utilizando broca 8mm

Marca la pared con un lápiz y taladrar con un taladro de 8 mm

Mark the wall with a pencil and drill using an 8mm drill



3. x6
Bucha 8mm

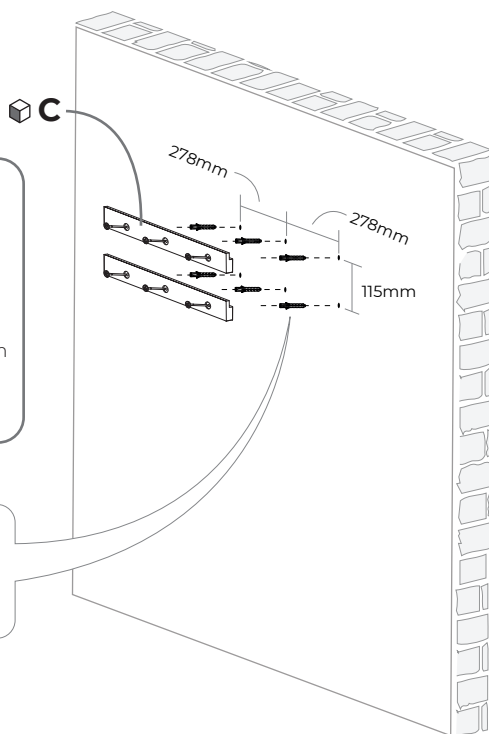

III.

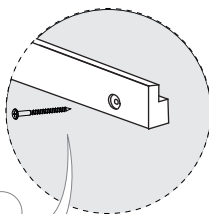

1. x6
Parafuso 5,5x65

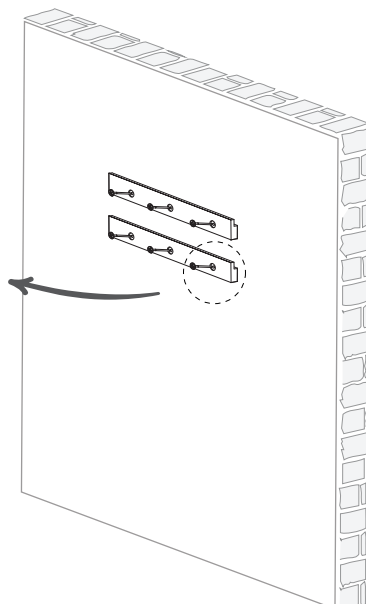

Caso sua parede seja drywall ou outro material, utilize bucha apropriada (não inclusa)

Si su pared es de paneles de yeso u otro material, use un anclaje de pared apropiado (no incluido)

If your wall is drywall or other material, use an appropriate wall anchor (not included)

IV.

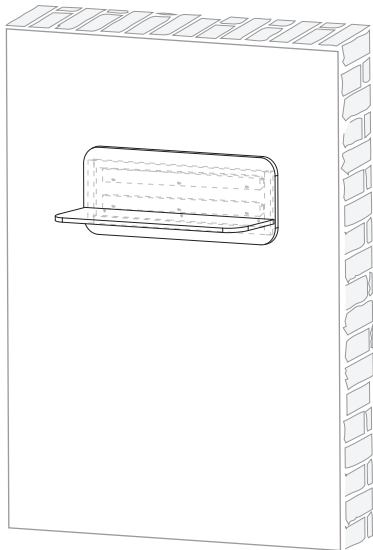
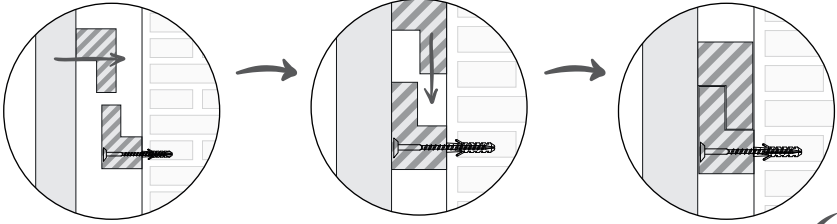
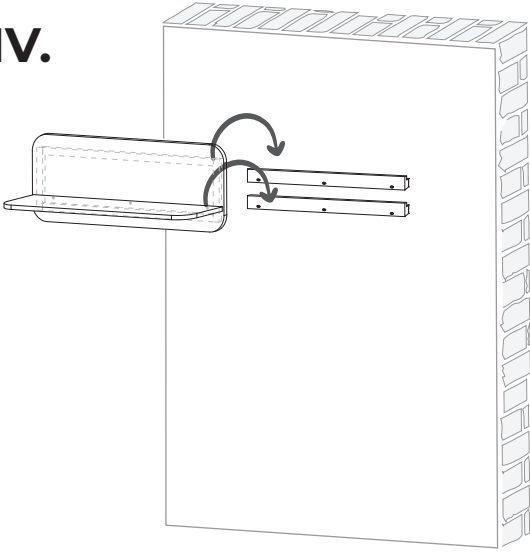

V.

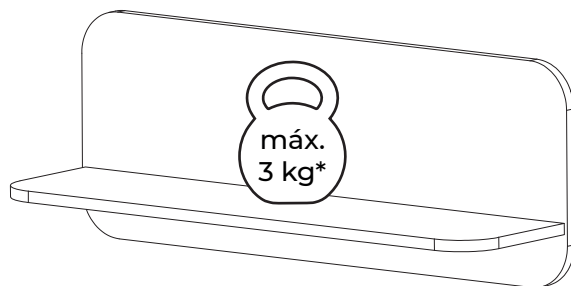

* Peso máximo por prateleira distribuído uniformemente na superfície.

* Peso máximo por estante distribuidos uniformemente en la superficie.

* *Maximum weight per shelf evenly distributed on the surface.*



Cuide bem do seu Veromobili!

Cuida bien de tu Veromobili!

Take good care of your Veromobili!

Limpeza

Madeira.

Utilize apenas produtos neutros e panos brancos levemente umedecidos para a limpeza. Nunca utilize produtos abrasivos.



Dobradiças e Corrediças.

Para as dobradiças e corrediças, utilize pano seco ou um pincel macio para retirar a poeira.

Limpieza

Madera.

Utilice únicamente productos neutros y paños blancos ligeramente humedecidos para la limpieza. Nunca use productos abrasivos.

Bisagras y brazos corredizos.

Para bisagras y guías, use un paño seco o un cepillo suave para quitar el polvo.

Cleaning

Wood.

Use only neutral products and lightly moistened white cloths for cleaning. Never use abrasive products.

Hinges and sliders.

For hinges and slides, use a dry cloth or a soft brush to remove dust.

Contato

Em caso de dúvidas, ligue pra gente. Ficaremos felizes em te ajudar!

Contacto

En caso de duda, llámanos. ¡Estaremos encantados en ayudarte!

Contato

If in doubt, call us. We will be happy to help you!



contato@veromobili.com.br
veromobili@veromobili.com.uy (Uruguay)



<https://www.veromobili.com.br/fale-conosco/>
<https://www.veromobili.com.uy/contacto/> (Uruguay)

Siga,
Curta,
Compartilhe!

#meuVero
#miVero

@veromobili