

Grande

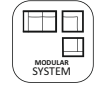

Comfort

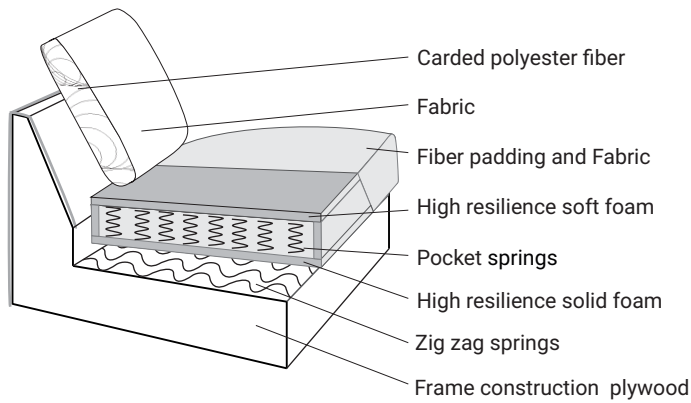

Extra dimensions

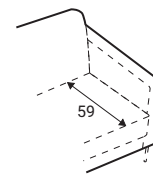

depth of seat

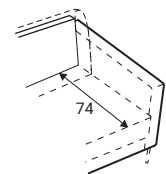

depth of seat without back cushions

Legs

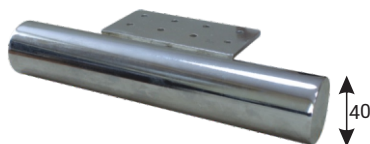

Feet M07 H-40
Chrome

Accessories

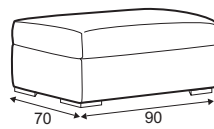

Footstool F5

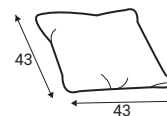

Pillow D5

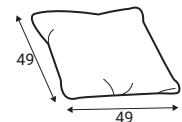

Pillow D1

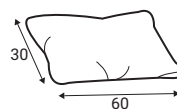

Pillow D3

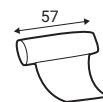

Neckrest

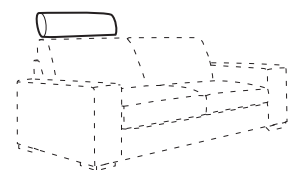



Grande



Modules

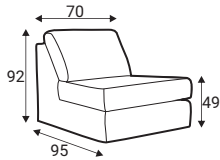

70 - middle part

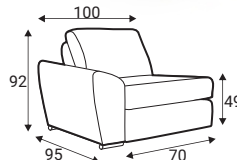

70L - left

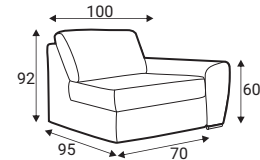

70R - right

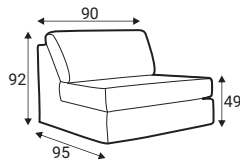

90 - middle part

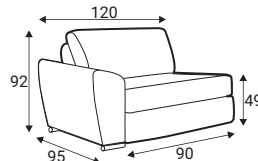

90L - left

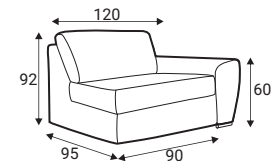

90R - right

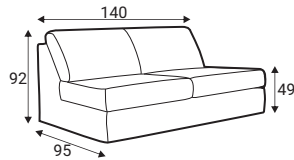

140 - middle part

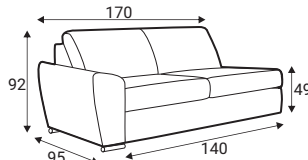

140L - left

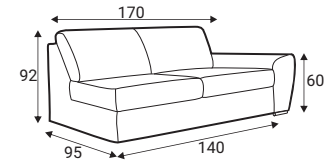

140R - right

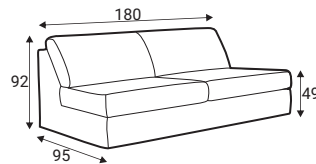

180 - middle part

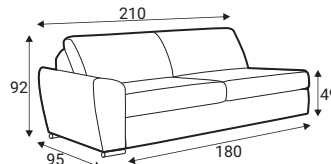

180L - left

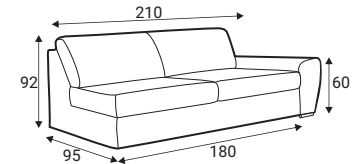

180R - right

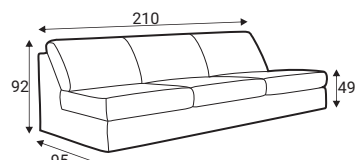

210 - middle part

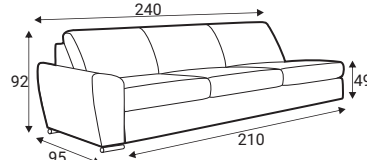

210L - left

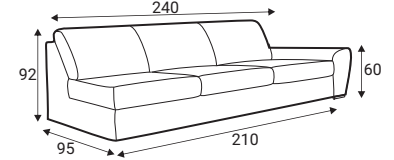

210R - right

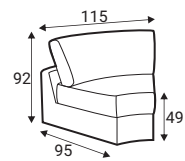

C45 - middle part

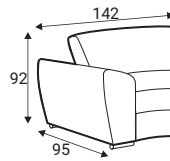

C45L - left

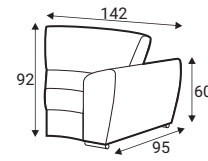

C45R - right

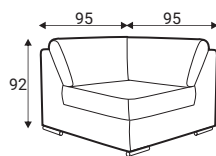

C - corner

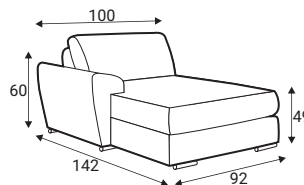

D70L - left

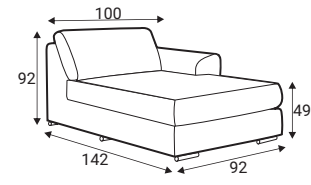

D70R - right



Grande



Modules

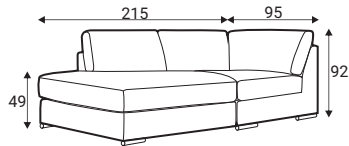

OC/L - left

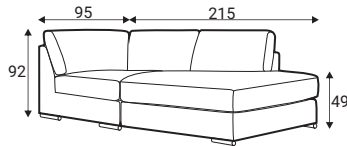

OC/R - right

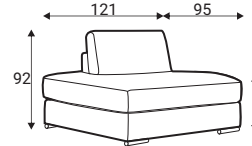

OE/L - left

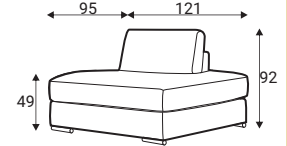

OE/R - right

Standard sets

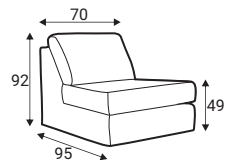

1S armless

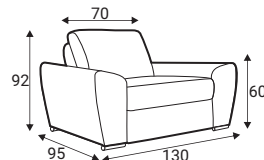

1S

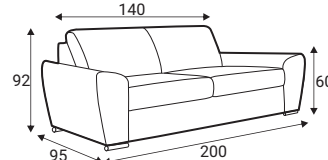

2S

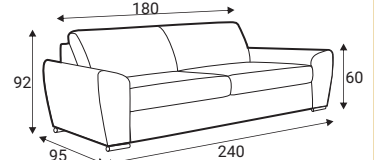

3S

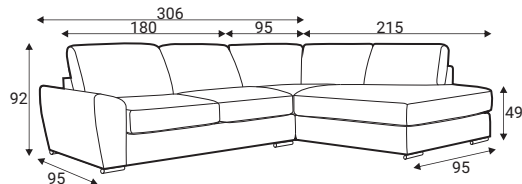

2 R/L

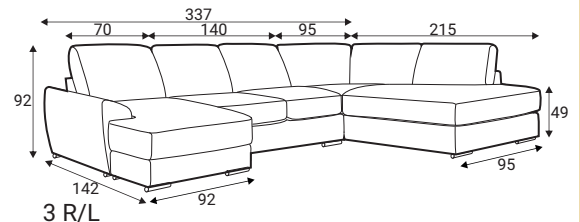

3 R/L

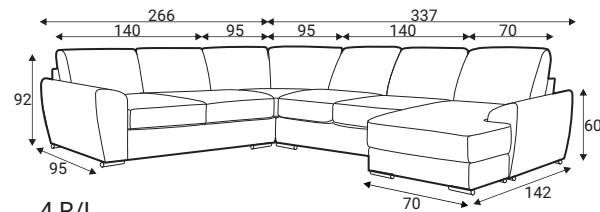

4 R/L

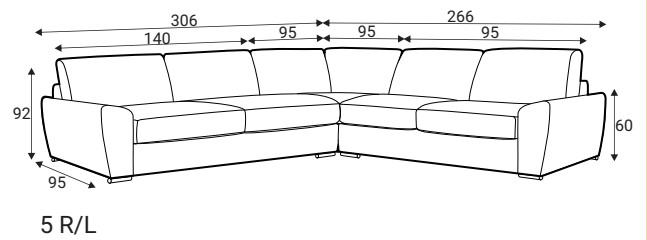

5 R/L

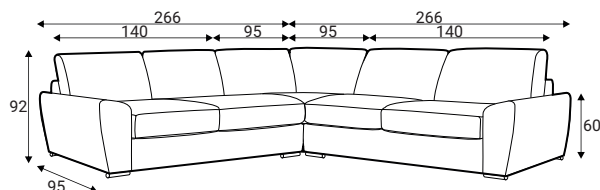

6 symmetrical

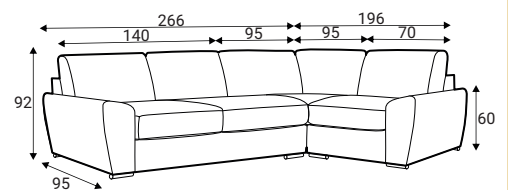

7 R/L

Quatropi reserves the right to change construction of products and components used due to improving durability of product and customer satisfaction without any further notice. Upholstered furniture is handmade using soft materials there fore measurements may vary up to +/- 3cm. Slight colour variations may occur between production batches. For technological reasons variations in color shades are acceptable.



Grande



Standard sets

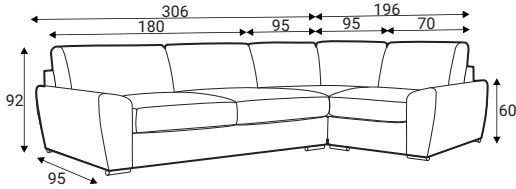

8 R/L

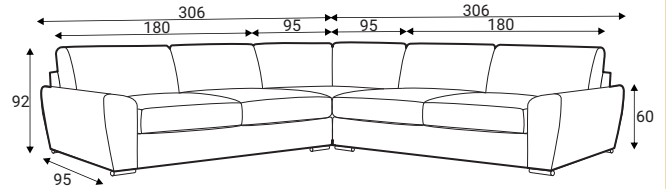

11 symmetrical

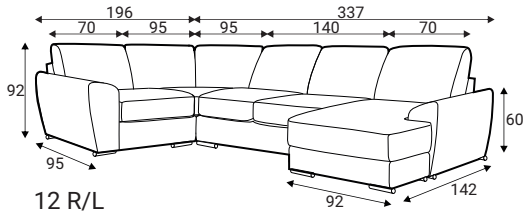

12 R/L

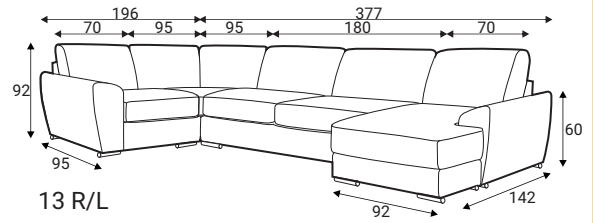

13 R/L

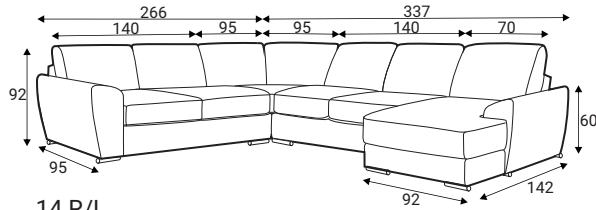

14 R/L

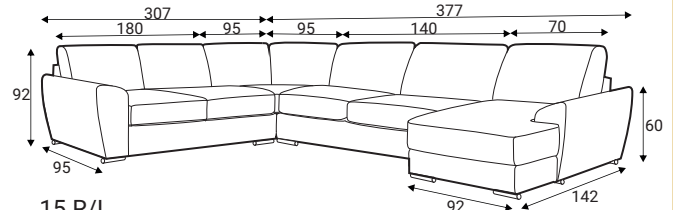

15 R/L

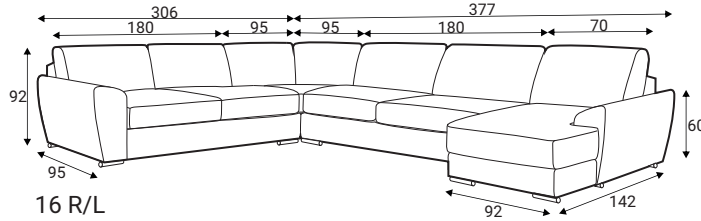

16 R/L

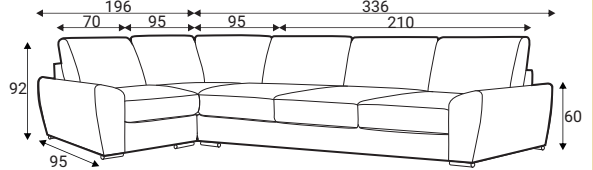

17 R/L

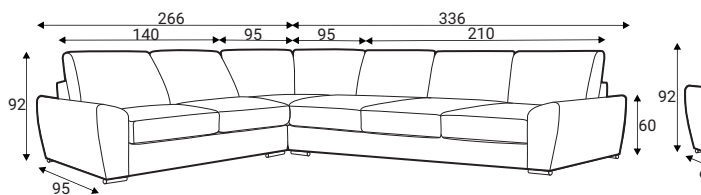

18 R/L

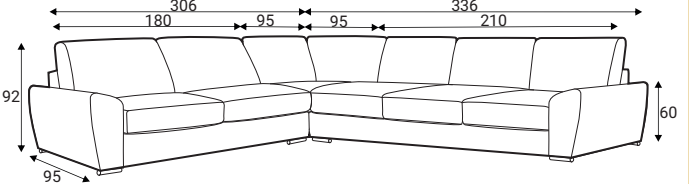

19 R/L



Grande



Standard sets

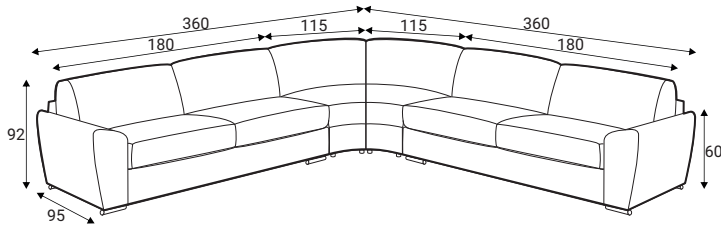

20 symmetrical

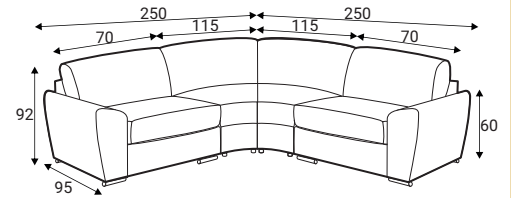

22 symmetrical

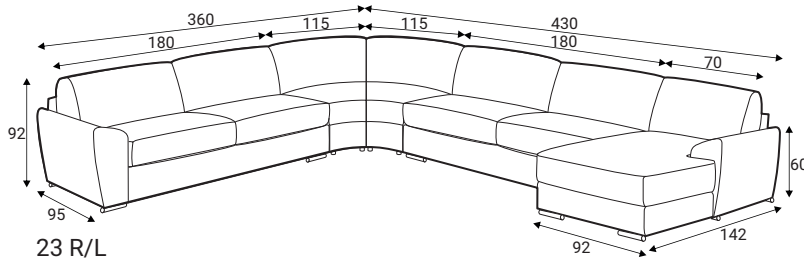

23 R/L

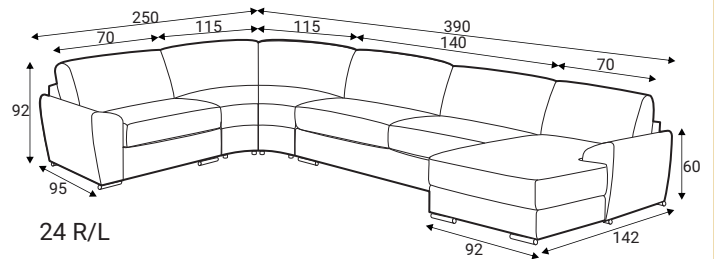

24 R/L

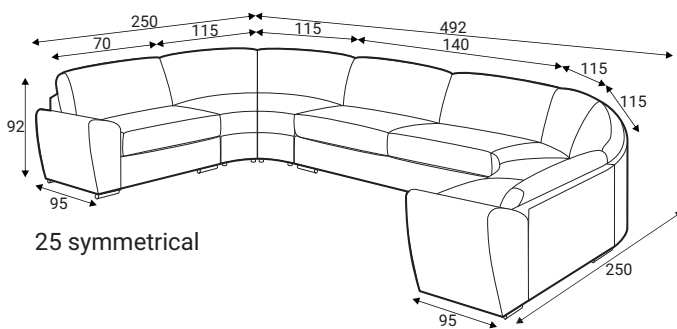

25 symmetrical

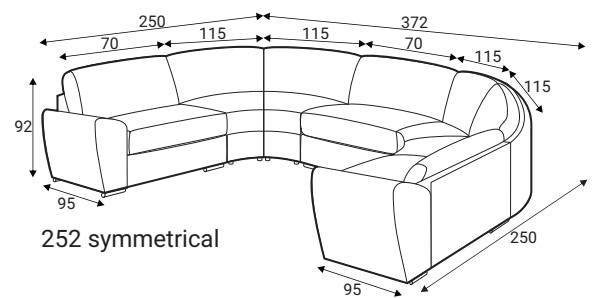

252 symmetrical

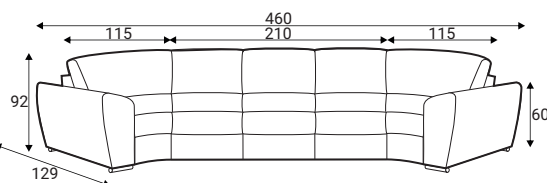

27 symmetrical

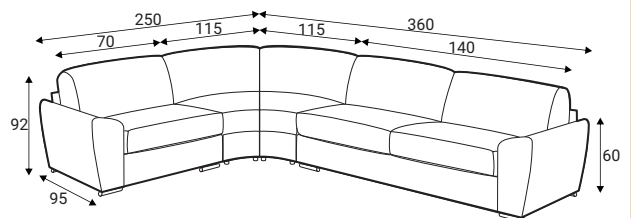

28 R/L



Grande



LOOSE



COVER
REMOVABLE



FABRIC



MODULAR
SYSTEM

Standard sets

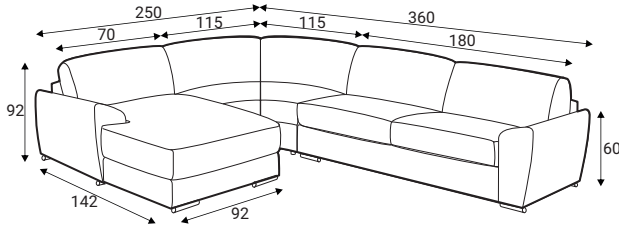

29 R/L

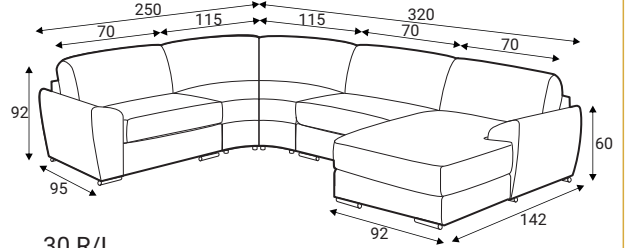

30 R/L

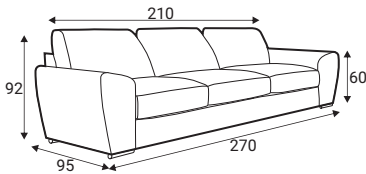

31 symmetrical

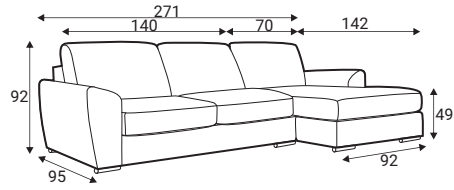

38 R/L

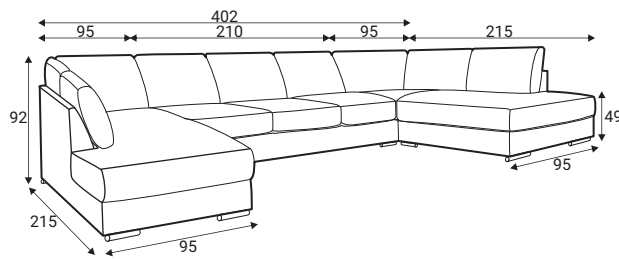

51 - symmetrical

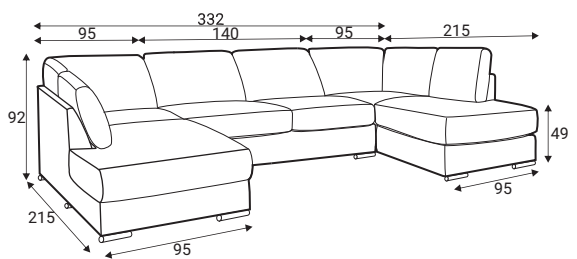

88 - symmetrical

Furniture features in symbols



LOOSE

- Seat and back cushions are loose from the frame.



FABRIC

- Fabric



COVER
REMOVABLE

- Removable cover for loose cushions.
(For maintenance please check fabric information.)



MODULAR
SYSTEM

- Modular system