

ARIEL

500 West Warner Avenue, Santa Ana, CA

ArielBath.com | AtlasUSA.net

Email: sales@arelbath.com | Phone: 1-714-622-1565

ARIEL

DZ962F8 Installation Instruction

Important safe information

1. Please read this instruction and assemble the steam shower according to it.
2. The leakage protection switch must be installed. Besides, please try it to check whether it is safe enough before formal using.
3. The ground line of the product must be connected to the earth permanently.
4. To avoid being shocked by the electricity, please prepare enough plugs and fixed them near to the steam shower. Please change those old or disrepair wires in time.
5. It is strictly forbidden to use the steam shower after drink or eat some hypnotic medicine.
6. Children should be guided by parents while using.
7. Especially note: The using water temperature should not pass 60 centigrade or 140 Fahrenheit.
8. Do not use any strong chemical liquid such as Vitriol, Hydrochloric acid, Lye and so on to clean the steam shower.
9. There is a connecting screw in the Wire Connecting Box, to avoid being shocked by the electricity, please be sure to connect this screw to the ground wire which is fixed on the power board. It is better to use the same size insulated wire to connect them, and the connecting wire diameter should not less than 1.5 square millimeter cooper-core wire.
10. Warning: To avoid being shocked by the electricity, please be sure to connect the DFCI/RCD to the ground plug.
11. If the steam shower with 3KW/4.5KW/6KW steam generator, the diameters of wires which are used not less than 2.5square millimeter/ 4square millimeter / 6square millimeter.
12. It is not allowed to use any moisture enhancing machine in the steam shower.

Installation wiring diagram

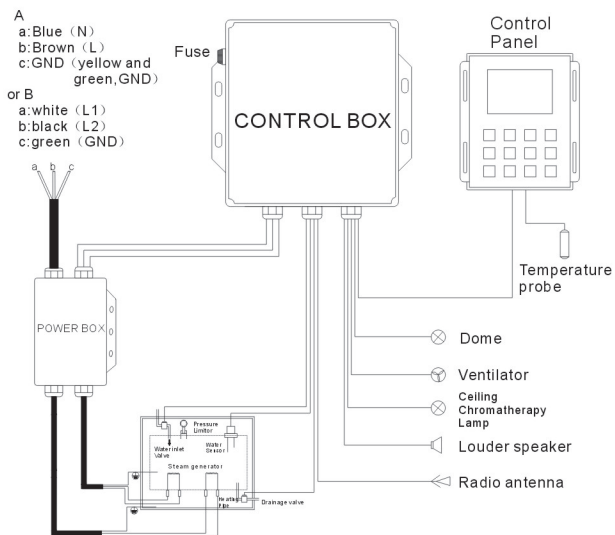

Electrical parts specification

Configuration	massage pump	steam generator	ceiling light	exhausting fan	Solenoid valves	CPU	Speaker	Note
Rating voltage		AC220-240V/50HZ	DC12V	DC12V	DC12V	AC220-240V/ 50HZ		
Rating voltage		AC240V/60HZ	DC12V	DC12V	DC12V	AC240V/60HZ		
Rating power		3000W	10W	3W	5W		10W	
Rating power		4500W	10W	3W	5W		10W	
Rating power		6000W	10W	3W	5W		10W	

CONTENTS





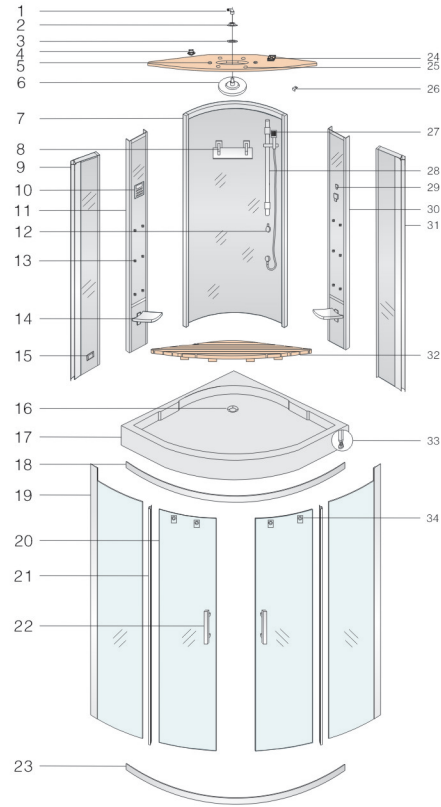

- 01-02 Component Directions
- 03 Technical Drawing
- 04-10 Installation steps
- 11-12 Control panel keys and function directions
- 13 Illustration for cleaning function
- 14 Maintenance service card
- 16 Troubles shooting

Parts instruction











1、4"4 copper elbow	2、1/2" copper nuts	3、4mm plastic seal	4、Loud speaker
			
5、Daylight lamp	6、Head shower	7、Mid glass panel	8、Tempered glass shelf
			
9、Left glass panel	10、F8 control panel	11、A back panel	12、cleaning cup
			
13、Jet	14、Folded seat	15、Steam outlet	16、Plastic drainer
			
17、Shower base	18、upper aluminum profile	19、Fixed door	20、Movable door
			
21、L011B waterproof seal	22、H-style handle	23、Bottom aluminum track	24、Ventilator
			

Parts instruction

25、Colorful light	26、Iron block	27、Hand shower
		
28、Socket for handshower	29、Spure 4 ways faucet	30、B back panel
		
31、Right back panel	32、962 wood floor	33、Adjustable leg
		
34、Wheels		
		

Parts package

4x16 self-locking screws:7pcs	962 block:11pcs
	
4x10 self-locking screws:33pcs	3.5x30 self-drilling screws:8pcs
	
3mm hexangular wrench:1pcs	931-1 supporter:4pcs
	
Binding strip:10pcs	4x25 self-drilling screws: 12pcs
	
Small cover:12pcs	
	

Technical drawing for water and electricity

Size:1200X1200X2260mm

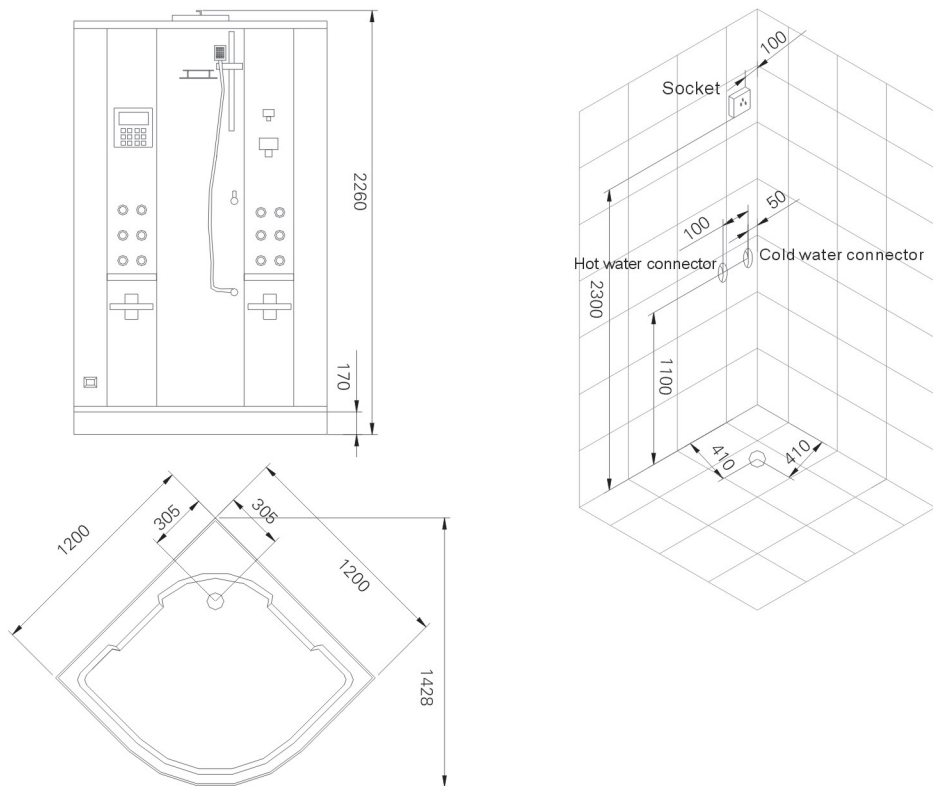

Installation instruction 1

Install the shower base

1. Take the shower base out from the carton and put it on the floor carefully.
2. Put the level ruler on the shower base to check whether the shower base is level. If not, please use a Wrench to adjust the adjusting legs to make the shower base become level. Illustrated in the drawing A.

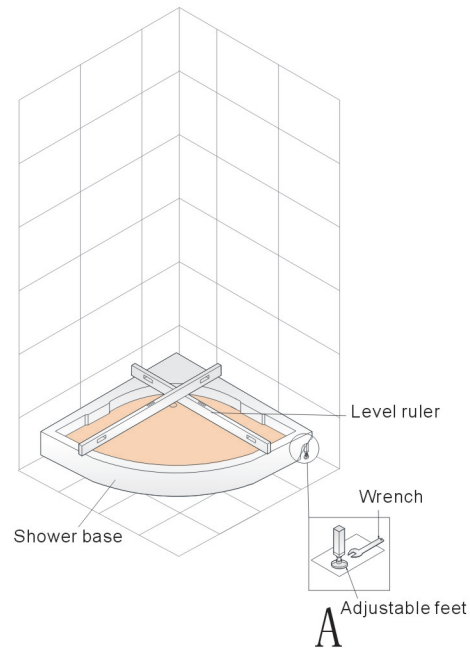

Installation instruction 2

Install front fixed glass doors

1. Put the No.1 lower aluminum track on the floor. Slide the No.3 right fixed door into the No.1 track, then use a Phillip Screwdriver to fix No.1 aluminum track and No.3 fixed door together with 3.5x30mm self-locking screws. Illustrate in the drawing A.
2. Slide the No.3 right door into the No.4 upper aluminum track, use a Phillip Screwdriver to fix them together with 3.5x30mm self-locking screws as well. Also according the illustration in the drawing A.
3. Use the same way to install the No.2 left fixed door to the No.1 and No.4 aluminum tracks.

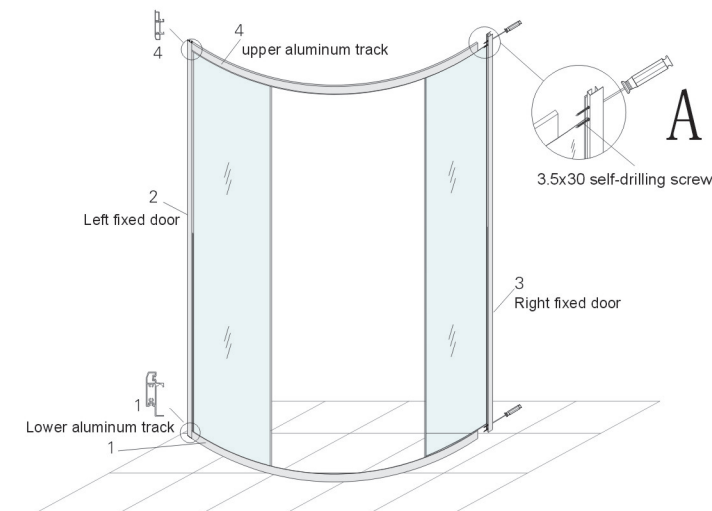

Installation instruction 3

Install the Fixed Glass Doors to the Shower Base

1. Cover the No.5 right corner aluminum profile onto the No.3 right installed fixed glass door doorframe (Illustrated in drawings A). Use the same way to cover the No.6 left corner aluminum profile on the No.2 left installed fixed glass doorframe. (Note: All the holes in the corner aluminum profile should fit all the holes in the left and the right fixed door very well.)
2. Please ask two persons to carry on the left and the right installed fixed glass doors, and put them on the shower base carefully. Then one person holds on the glass doors, the other person uses a Phillip Screwdriver to fix them to the base with 4x10mm self-locking screws. Illustrated in the drawing B.

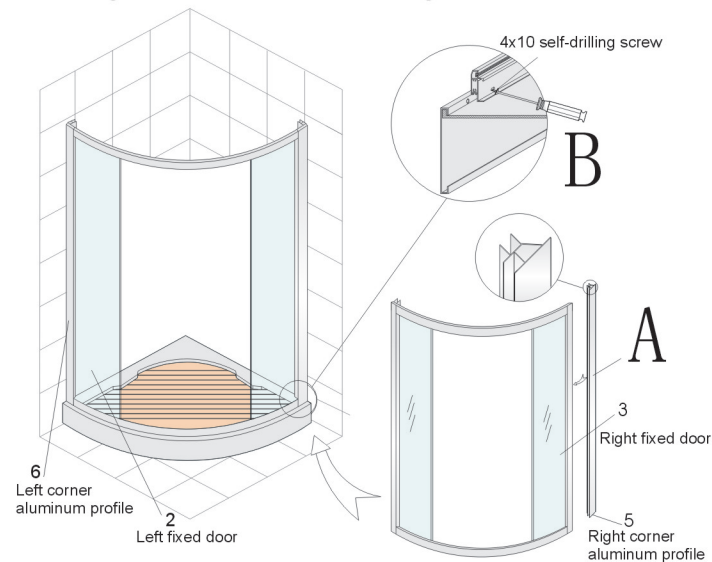

Installation instruction 4

Install the left side back panel and the right side back panel.

1. Take the No.1 left side back panel out of the carton and carry it through the open door, then put it on the shower base carefully. Insert the No.1 panel to the Corner Aluminum Profile of the left fixed door. Then use a Phillip Screwdriver to fix them with 4x10mm self-locking screw. Illustrated in the drawing A.
2. Use the same way to fix No.2 panel to the right fixed door.

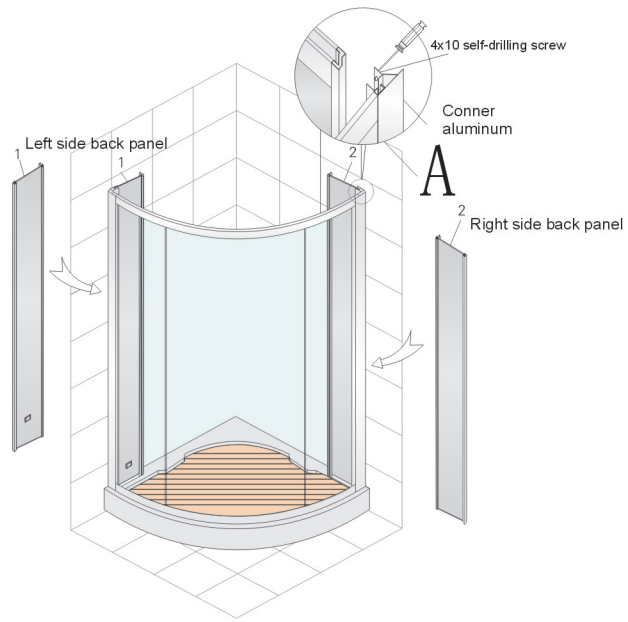

Installation instruction 5

Install the left back panel and the right back panel

1. Carry the B right back panel through the open door and put it on the shower base carefully, then use a Phillip Screwdriver to fix B panel to No.2 panel with 4x25mm self-locking screws. Illustrated in the drawing E.
2. Cover the small covers to the small holes. Please kindly note when users want to amend spare parts behind of the mid back panel, just need to take the cover off and unscrew the screws in the small holes and then users can take the mid panel off very easily, no need to move the whole steam shower out. Illustrated in the drawing F.
3. Use the same way to install the A back panel to the No.1 panel.

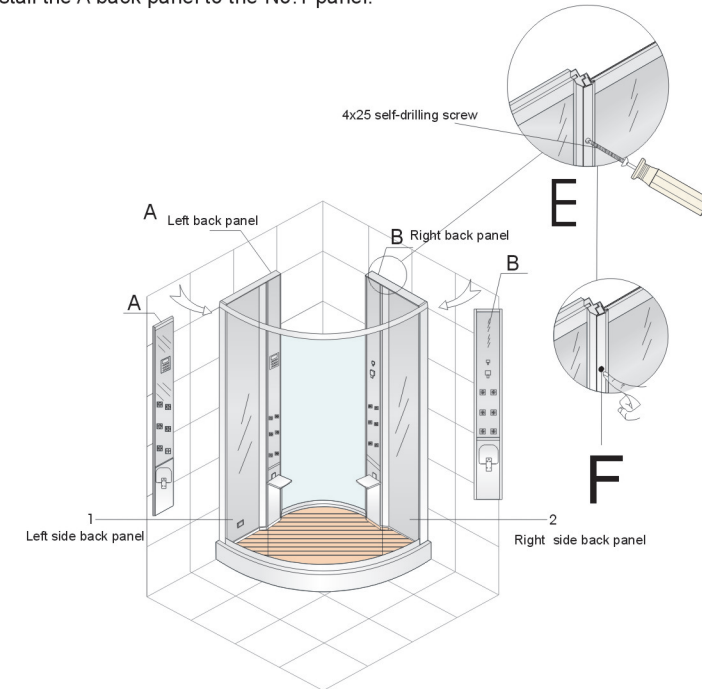

Installation instruction 6

Install the mid panel

1. Carry the No.3 mid panel through the open door and put it on the base carefully, then use 4x25mm self-locking screws to fix it to A panel and B panel. Illustrated in the drawing E.
Cover the small covers to those small holes. Illustrated in the drawing F.
2. Use 4x16mm self-locking screws and 4mm cushion to fix all the back panels to the shower base, illustrated in the drawing G.

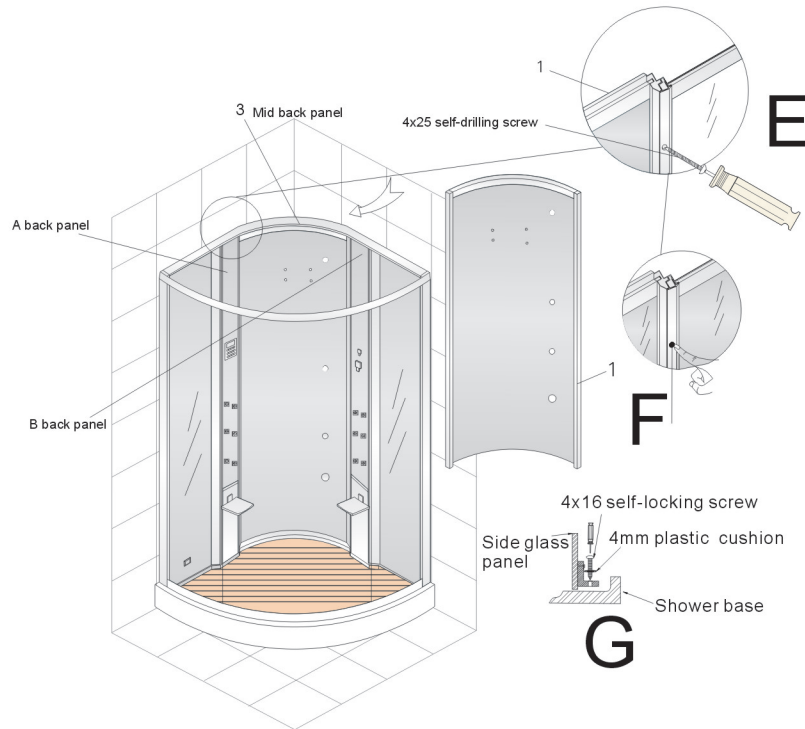

Installation instruction 7

Install the Movable Door and the Top Cover

1. Hang up the movable door to the upper aluminum track (Illustrated in the drawing A), and then press the lower wheel to hook it into the lower aluminum track (Illustrated in the drawing B). Note: There is a Spring in the Upper Wheel. If there is a gap between the Movable Door and the Fixed Door, or the Movable Door can not swing very well, please adjust the Upper Wheels.
Adjust Way: Use a Phillip Screwdriver to adjust the Screw at the bottom of the Upper Wheel, to make the Movable Door vertical.
2. Use a Hexangular Wrench to install the handles. Illustrated in the drawing C.
3. Cover the Water Proof Rubbe to the Movable Door. Illustrated in the drawing D.
4. Put the Top Cover on the steam shower carefully, then use 4x10mm self-locking screws and stainless steel block to fix the Top Cover to all the back panels. Illustrated in the drawing E and F.

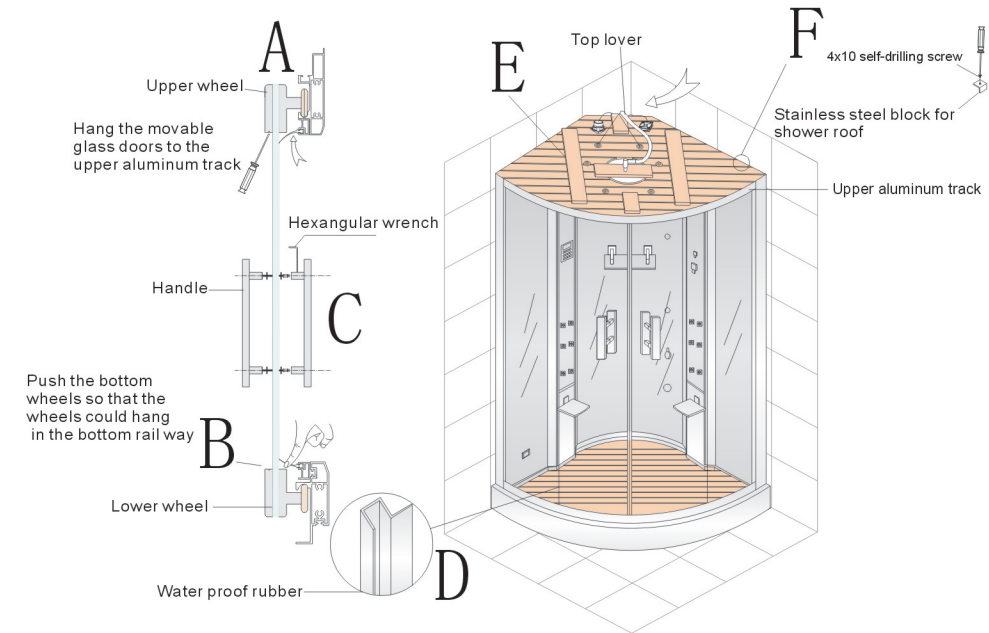

Installation instruction 8

Install Accessories and Connect Wires

1. Install the Glass Shelf: Use a Phillip Screwdriver to fix the Glass Clip to the back panel with 4x16mm screws, 4mm plastic cushion, 6mm plastic cushion and 4mm nuts, illustrated in the drawing A. Then put the Glass Shampoo Holder on the track of Glass Clip and use a Phillip Screwdriver to fix them well. Illustrated in the drawing B.
2. Install the Up and Down Hand Shower Bracket: Use a Phillip Screwdriver to install the Up and Down Hand Shower Bracket to the back panel with 4x16mm screws, 4mm plastic cushion, 6mm plastic cushion and 4mm nuts. Illustrated in the drawing C.
3. Connect the hand shower chain to the hand shower socket. Illustrated in the drawing D.
4. Put the solid wood floor into the steam shower carefully.
5. Find out the Ventilator sign, the Lamp sign, and the Louder Speaker sign which are on the behind of the back panel, then connect the relative wires of these spare parts to the relative sockets. Illustrated in the following drawing.

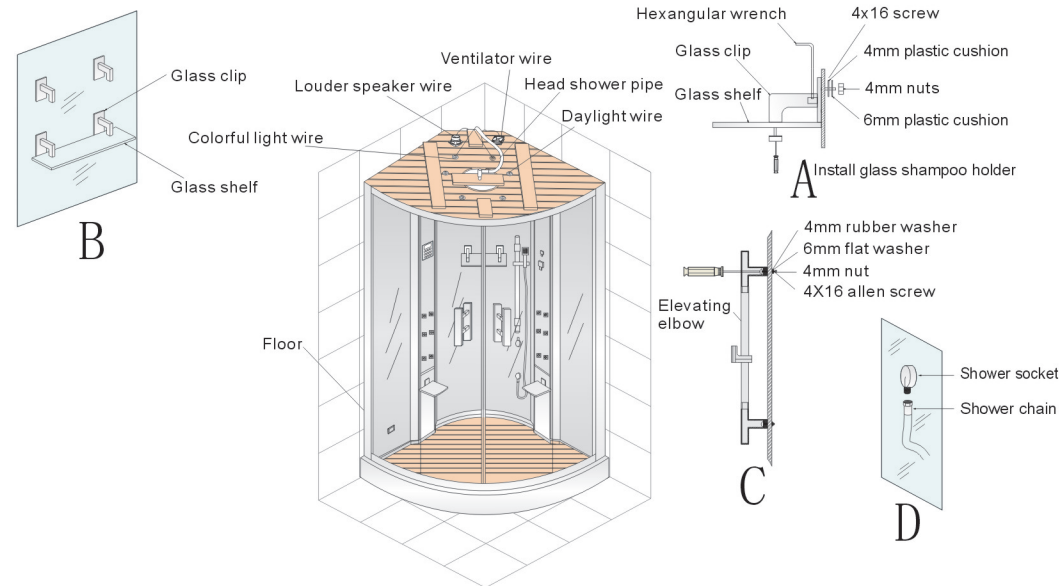

Installation instruction 9

Connect Fittings and Water Pipes

1. Connect the head shower pipe to the head shower joint. Connect the water outlet pipe to the shower base and connect the steam pipe to the steam outlet, illustrated in the drawing A.
2. Connect the hot water inlet pipe and the cold water inlet pipe separately to the relative joints. Illustrated in drawing A, B and C.
3. Especially note: The thermostatic faucet is an optional function, just when customers require to install this spare part and we will do, the standard steam shower is without the thermostatic function. Illustrated in drawing D and E.

Note: Before use the steam shower, please try to test whether all the functions are ok.

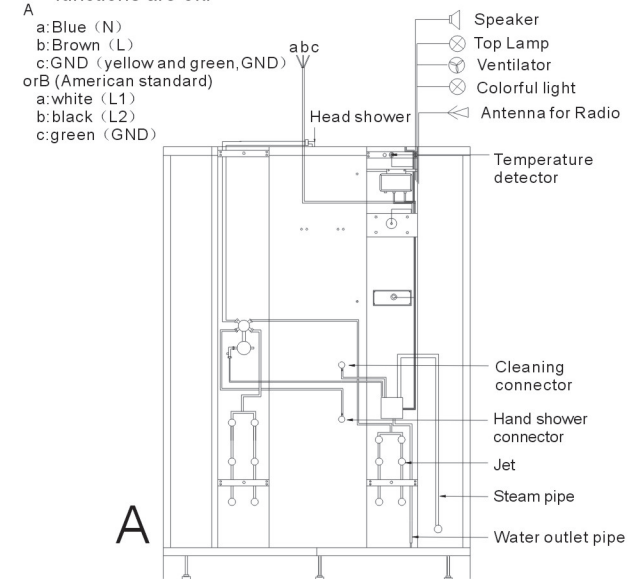

Stand faucet

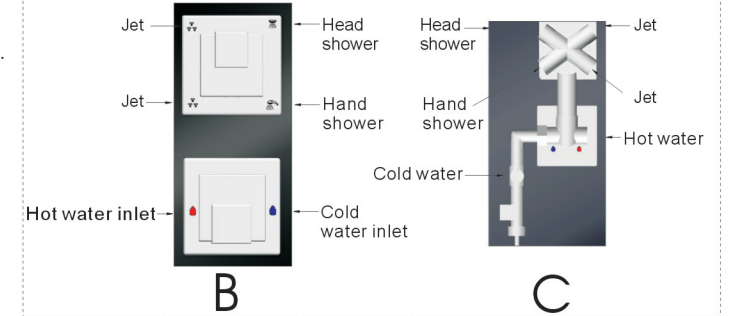

Optional thermostatic

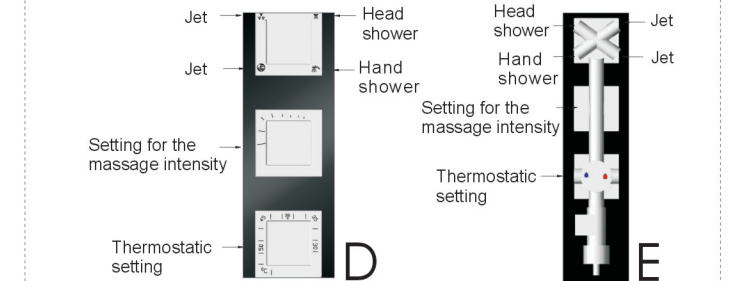

F8 Control panel keys and operating instructions

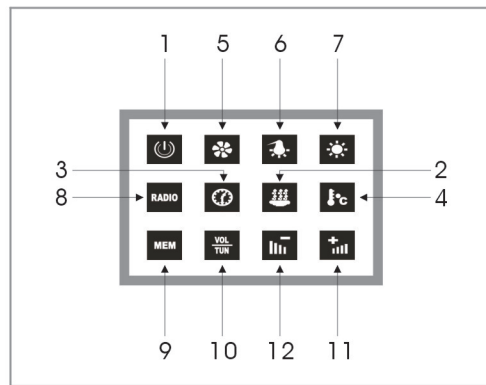

1).Power key

Press to switch on the steam room, press again to switch it off. The steam room will shut down in 60 minutes automatically. (As picture1)



As picture1

2).Steam key

Press The steam generator starts working. The temperature will be shown on the control panel like the picture 2.



As picture2

3).Time adjusting

After the steam function is turned on, press will increase the setting time. When press the more than 1 second, the setting time will be increased continuously until you stop pressing.Or, just when it reaches the maximum limiting time(50 minutes) after that it will return to the minimum limiting time(5 minutes) autmotatically.
Note: The time setting range is between 5-50 minutes. The default time setting is 30 minutes. (As picture3)



As picture3

4).Temperature adjusting key

After steam function is turned on, press will increase the temperature. When press more than 1 second, the setting temperature will be increased continously until you stop pressing Or,just when it reaches the maximum limiting temperature that it will return to the minimum limiting temperature automatically.
Note:The temperature setting range is between 20 °C-50°C.The controlled temperature tolerance: ± 3°C The default temperature is 40°C.



As picture4

5).Ventilator key

Press to turn on the ventilator , press again to turn off the ventilator.



As picture5

6).Color light key

Press to turn on the color light. After the color light is turned on, each more press will change the different colors of the light. The color light works in this sequence: Turn on, blue ---blue and red ---red---red and orange---orange ---orange and blue---blue---circulating---turn off.



As picture6

7).Lamp key

Press the key to turn on the lamp, press again and turn it off. (As picture 6)

8).Radio key

Press to turn on the radio, press again to turn off the radio.(As picture 7)



As picture7

9).Channel memory key

Press and release within 1 second, the frequency of current channel will be changed; Press and hold it more than 1 second, the frequency of current chanel will be saved.It can memory total 8 channels.

F8 control panel key and operation instructio

10).Select key

This key gets double functions. When the radio is turned on, this key shows the Frequency function.Press the key and it can be switched from the frequency to the volume function. Press the key, on the Displayer will show like the (Picture 10) or (picture 9). (Picture 9) is for volume and (picture 10) is for frequency.



As picture8

11).Volume up key

After the radio is turned on (As picture9), press will increase the volume. Hold on the key more than 1 second, volume will keep increasing until the key is released. When(picture10) shows on the displayer, press will increase the frequency.Hold on the key more than 1 second, the frequency will keep increasing until the key is released.



As picture9

12).Volume down key

After the radio is turned on, when (Picture 9) is shown on the displayer, press will decrease the volume. Hold on the key more than 1 second, volumed will keep decreasing until the key is released. When (picture10) is shown on the displayer,press will decrease the frequency.Hold on the key more than 1 second, the frequency will keep decreasing until the key is released.



As pictur10

User's manual for cleaning the steem generator

Using steps: Turn off the power first, and then open the lid of cleanning cup, put the cleaning liquid in the cleanning cup, after that, cover the lid back. Now turn on the power , start the steam function to make the self-cleaning function work, later turn off the power, and pipe water away.

1).Power off

For safety, it is strictly prohibited to open the lid of the easy cleaning cup during using. In order to avoid steam gas emits out and scald users, please shut down all other functions before using the steam generator  cleaning function. (As picture 11)

2).Open the easy cleaning cup

After Making sure all of functions are turned off, find out the cleaning cup according the right picture illustrated, and rotate the lid of the cleaning cup to the reverse direction, and then take the lid out slightly. (As picture12)



3).put the cleaning liquid

After opening the cleanning cup, use a spoon to take a proper amount of cleaning liquid, such as Citric acid, or neutral compound cleaning liquid (around 5 ml) to put in the cleaning cup. Note: If the cleaning material is solid, first, please dissolve it with water to prevent blocking.Strictly prohibit to use any other acid, alkaline compounds to be poured into the cleanning cup directly(As picture13).



4).Cover the lid

After adding the cleaning liquid, cover the lid back and turn it in clockwise direction to fasten,like this can prevent the steam emitting out to scald users(As picture14).

5).Turn on and start the steam function

After covering the lid, press  to turn on the steam generator function, and the system  will begin to clean the steam box automatically.(As picture15)

6).Turn off the power and drain out the waste water

After 5-10 minutes, press the  to turn off the steam generator, then press the , the waste water will be drained out automatically(As picture16).



As picture 11

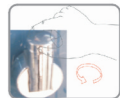

As picture 12



As picture 13

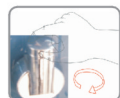

As picture 14

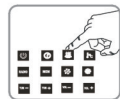

As picture 15



As picture 16

Notice:

1. Strictly prohibit to use the cleaning function while any other function is on;
 2. Strictly prohibit to use any other alkaline cleaning compound to clean steam generator;
 3. Strictly prohibit to use any solid cleaning agent to clean steam generator, in order to avoid blocking the pipe.
- We recommend that you use citric acid solution to clean steam generator!

Maintenance service card

Item number			
Serial number		Purchasing date	
Phone number			
<p>Eago guarantees to keep: Eago series' products in good repair against the maintenance service card and purchasing receipt since the purchasing date. If it is the product quality problem, it will be free maintenance or change the spare parts. If the problem is not caused by the products itself or over-exceed the one-year guarantee, it will charge the repairing fees and spare parts costs.</p>			

The first page is kept for the customer.

Maintenance service card

Item number	
Serial number	
Customer name	
Phone number	
Address	
Agent shop	
Phone number	
Purchasing date	

The second page is sent back to eago head office.

Maintenance service card	
Item number	
Serial number	
Customer name	
Phone number	
Address	
Agent shop	
Phone number	
Purchasing date	

Steam shower room trouble shooting

Malfunction Status	Reasons	Solutions
Small volume inlet water	<ol style="list-style-type: none"> 1. Lower inlet water pressure 2. The water inlet pipe is blocked 	<ol style="list-style-type: none"> 1. Check the inlet water pressure, then check with local plumber 2. Clean the filtre
Water divert valve can't divert water	<ol style="list-style-type: none"> 1. Rubber inside the valve damaged or distorted 	<ol style="list-style-type: none"> 1. Change a new one
No signal on the control panel	<ol style="list-style-type: none"> 1. There is no power in the user's house or the wire not connected well 2. Not switch the power on 3. The connecting wire for the control panel becomes loose 	<ol style="list-style-type: none"> 1. Need to wait the power on, connect wires in right way 2. Swtich on the power 3. Take it off and install it again, don't forget fasten it
There is steam signal on the control panle, but no steam comes out	<ol style="list-style-type: none"> 1. The Temperature limiter operate or the heater is broken 	<ol style="list-style-type: none"> 1. Ask help to qualified people
Chromatherapy light doesn't work	<ol style="list-style-type: none"> 1. The connecting wire blew out or the lamp holder loosen 2. Lamp pannel is broken 	<ol style="list-style-type: none"> 1. Change a new one or install it well again 2. Change a new one
Ventilator doesn't work	<ol style="list-style-type: none"> 1. The connecting wire is off 2. The fan blade gets stuck 3. The ventilation fan is broken 	<ol style="list-style-type: none"> 1. Reconnect it well 2. When the fan is on spur the blades slightly 3. Change a new one